

# Hormaphidinae from Java (Homoptera: Aphididae)

D. Noordam

Noordam, D. Hormaphidinae from Java (Homoptera: Aphididae).

Zool. Verh. Leiden 270, 24.xii.1991: 1-525, figs. a-o + 1-579, colour pls 1-48.— ISSN 0024-1652/  
ISBN 90-73239-03-6.

Key words: Aphididae; Aleurodaphis; Astegopteryx; Cerataphis; Ceratoglyphina; Ceratovacuna; Distylaphis; Euthoracaphis; Glyphinaphis; Mesothoracaphis; Metanipponaphis; Neohormaphis; Nipponaphis; Pseudoregma; Rappardiella; Reticulaphis; Schizoneuraphis; Sinonipponaphis; Thoracaphis; taxonomy; key; Java; galls; bamboo; palms; orchids.

Descriptions are given of 18 genera and 56 species, with keys to the apterae and alatae viviparae. The following new genera and species are described: *Astegopteryx glandulosa* spec. nov., from *Gigantochloa* spec. and other bamboos; *A. setigera* spec. nov., from *Styrax benzoin* Dryander; *Cerataphis pothophila* spec. nov., from *Pothos roxburghii* de Vriese; *Ceratovacuna floccifera* spec. nov., from bamboo; *C. ke-duensis* spec. nov., from bamboo; *Distylaphis* gen. nov. (with type species *Schizoneuraphis foliorum* Van der Goot, 1917); *Mesothoracaphis* gen. nov. (with type species *Thoracaphis rappardi* H.R. Lambers and Takahashi, 1969); *Metanipponaphis vanderhooti* spec. nov., from *Lithocarpus sundaicus* (Bl.) Rehd.; *Neohormaphis* gen. nov., with *N. calva* spec. nov. from *Distylium stellare* O.K., and *Quercus* spec.; *Nipponaphis brevipilosa* spec. nov., from *Castanopsis argentea* (Bl.) DC.; *N. javanica* spec. nov., from *Castanopsis acuminatissima* (Bl.) A. DC., and *Quercus* spec.; *N. multisetosa* spec. nov., from *Castanopsis javanica* (Bl.) DC.; *N. semiglabra* spec. nov., from *Lithocarpus bennettii* (Miq.) Rehd.; *Rappardiella* gen. nov. (with type species *Oregma loranthi* Van der Goot), with *R. cerina* spec. nov., from *Dendrophthoë pentandra* (L.) Miq.; *R. macrosoleni* spec. nov., from *Macrosolen cochinchinensis* (Lour.) Tiegh.; *R. plicator* spec. nov., from *Scurrula* spec.; *R. scurrulae* spec. nov., from *Scurrula* spp.; *Schizoneuraphis litseicola* spec. nov., from *Litsea amara* Bl.; *S. longisetosa* spec. nov. from galls of *Distylium stellare* O.K.; *Sinonipponaphis hispida* spec. nov., from *Lithocarpus indutus* (Bl.) Rehd. *Astegopteryx unimaculata* spec. nov. for *Oregma insularis* sensu Van der Goot (1917).

D. Noordam, Edeseweg 58, 6721 JX Bennekom, The Netherlands.

## Contents

Introduction .....	5
Measurements .....	6
Plates .....	9
Captions of plates 1-48 .....	17
Keys to the genera .....	21
Key based on apterae .....	21
Key based on alatae .....	24
Keys to the species .....	26
Key based on apterae .....	26
Key based on alatae .....	38
Descriptions .....	46
<i>Aleurodaphis</i> Van der Goot, 1917 .....	46
<i>A. blumeae</i> Van der Goot, 1917 .....	47
<i>Astegopteryx</i> Karsch, 1890 .....	50
<i>A. bambusae</i> (Buckton, 1893) .....	53
<i>A. basalis</i> (Van der Goot, 1917) .....	59
<i>A. glandulosa</i> spec. nov. ....	63
<i>A. minuta</i> (Van der Goot, 1917) .....	66
<i>A. muiri</i> (Van der Goot, 1918) .....	68
<i>A. nipae</i> (Van der Goot, 1917) .....	72
<i>A. pallida</i> (Van der Goot, 1917) .....	75

<i>A. pandani</i> (Takahashi, 1935) .....	81
<i>A. rappardi</i> Hille Ris Lambers, 1953 .....	82
<i>A. rhapsidis</i> (Van der Goot, 1917) .....	86
<i>A. setigera</i> spec. nov. ....	90
<i>A. singaporensis</i> (Van der Goot, 1918) .....	94
<i>A. styracophila</i> Karsch, 1890 .....	96
<i>A. unimaculata</i> spec. nov. ....	99
<i>Cerataphis</i> Lichtenstein, 1882 .....	103
<i>C. fransseni</i> (Hille Ris Lambers, 1933) .....	105
<i>C. freycinetiae</i> Van der Goot, 1917 .....	109
<i>C. lataniae</i> (Boisduval, 1867) .....	113
<i>C. orchidearum</i> (Westwood, 1879) .....	116
<i>C. palmae</i> (Ghesquière, 1934) .....	119
<i>C. pothophila</i> spec. nov. ....	124
<i>Ceratoglyphina</i> Van der Goot, 1917 .....	127
<i>C. bambusae</i> Van der Goot, 1917 .....	129
<i>C. bengalensis</i> L.K. Ghosh, 1972 .....	133
<i>Ceratovacuna</i> Zehntner, 1897 .....	136
<i>C. floccifera</i> spec. nov. ....	138
<i>C. graminum</i> (Van der Goot, 1917) .....	141
<i>C. kedzensis</i> spec. nov. ....	144
<i>C. lanigera</i> Zehntner, 1897 .....	146
<i>C. panici</i> (Van der Goot, 1917) .....	150
<i>Distylaphis</i> gen. nov. ....	154
<i>D. foliorum</i> (Van der Goot, 1917) .....	155
<i>Euthoracaphis</i> Takahashi, 1938 .....	162
<i>E. heterotricha</i> A.K. Ghosh & Raychaudhuri, 1973 .....	163
<i>Glyphinaphis</i> Van der Goot, 1917 .....	164
<i>G. bambusae</i> Van der Goot, 1917 .....	165
<i>Mesothoracaphis</i> gen. nov. ....	168
<i>M. rappardi</i> (Hille Ris Lambers and Takahashi, 1959) .....	170
<i>Metanipponaphis</i> Takahashi, 1959 .....	173
<i>M. vandergooti</i> spec. nov. ....	175
<i>Neohormaphis</i> gen. nov. ....	179
<i>N. calva</i> spec. nov. ....	181
<i>Nipponaphis</i> Pergande, 1906 .....	186
<i>N. brevopilosa</i> spec. nov. ....	188
<i>N. ficicola</i> Hille Ris Lambers and Takahashi, 1959 .....	192
<i>N. javanica</i> spec. nov. ....	194
<i>N. multisetosa</i> spec. nov. ....	198
<i>N. semiglabra</i> spec. nov. ....	201
<i>Pseudoregma</i> Doncaster, 1966 .....	203
<i>P. bambusicola</i> (Takahashi, 1921) .....	206
<i>P. montana</i> (Van der Goot, 1917) .....	211
<i>P. nicolaiiae</i> (Takahashi, 1935) .....	215
<i>P. panicola</i> (Takahashi, 1921) .....	218
<i>P. pendleburyi</i> (Takahashi, 1950) .....	223
<i>P. sundanica</i> (Van der Goot, 1917) .....	226
<i>Rappardiella</i> gen. nov. ....	231
<i>R. cerina</i> spec. nov. ....	233
<i>R. loranthi</i> (Van der Goot, 1917) .....	235
<i>R. macrosoleni</i> spec. nov. ....	239
<i>R. plicator</i> spec. nov. ....	242
<i>R. scurrulae</i> spec. nov. ....	246
<i>Reticulaphis</i> Takahashi, 1958 .....	249
<i>R. distylii</i> (Van der Goot, 1917) .....	250

<i>Schizoneuraphis</i> Van der Goot, 1917 .....	259
<i>S. gallarum</i> Van der Goot, 1917 .....	262
<i>S. litseicola</i> spec. nov. ....	270
<i>S. longisetosa</i> spec. nov. ....	273
<i>Sinonipponaphis</i> Tao, 1966 .....	277
<i>S. hispida</i> spec. nov. ....	277
<i>Thoracaphis</i> Van der Goot, 1917 .....	279
<i>T. arboris</i> Van der Goot, 1917 .....	281
Acknowledgements .....	285
References .....	285
Figures .....	288
Index .....	521

### Introduction

This is the third part of the series on the aphids of Java. The first two parts have been published in 1985 (Noordam & Hille Ris Lambers, 1985) and 1986 (Noordam, 1986). Fifty-six species of Hormaphidinae of Java are described in this paper, which is almost one third of the Javanese aphid fauna.

When these aphids are encountered in nature on bamboos, palms and other hosts, one is immediately struck by the uniformity of each population. However, when comparing several populations of the same species the enormous variability, probably dependent on the age of the population, soon becomes apparent. At no time did the author trace the adventures of any single population for its entire life-cycle, but he was able to draw his conclusions only by collecting many populations at different times over a three-year period. Photographic records proved indispensable for the establishment of intraspecific variability, the interpretation of which can be confusing when based on microscopic observation alone. It is clear from Van der Goot's (1917) book on Javanese aphids that he was not sufficiently aware of this degree of variability, and consequently described several species which in the opinion of the present author belong to a single species.

All Javanese Hormaphidinae propagate by parthenogenesis, and oviparous females have been found in only one species, *Distylaphis foliorum*. These oviparae were described by Van der Goot in an unpublished manuscript. Host alternation occurs in aphids which have *Distylium stellare* and *Styrax benzoin* as primary host plants. On the basis of microscopic observations, Hille Ris Lambers and Takahashi (1959) demonstrated host-alternation in *Schizoneuraphis gallarum* and *Reticulaphis distylii*. In the present publication *Neohormaphis calva* is added to these two species.

It is probably too bold an assumption to suggest host-alternation in a fourth species, *Distylaphis foliorum* which has gall-inhabiting morphs on *Distylium stellare*, and a free-living generation on the leaves of the same host. There is no doubt that host-alternation occurs in *Astegopteryx styracophila*, *A. setigera*, and *Cerataphis fransseni*, but the secondary host plants remain unknown.

Hormaphidinae are remarkable in having larval stages which frequently differ markedly from the adults. For this reason, larval stages are usually described, including the kinds of soldiers, in *Astegopteryx*, *Ceratovacuna*, *Distylaphis* and *Pseudoregma*.

Horns and dagger-like or robust setae on the head are characteristic of many

species. In this publication, much attention is also paid to the occurrence of several kinds of wax glands. These may appear in groups, in the form of button organs, as separate irregular pustules or as linear areas, s-shaped glands or in the shape of convolutions or circles.

Discussions have been reduced to a minimum. Some discussions can be found in the introduction to each species, but the relationships and differences between species become familiar to the reader from the keys. Differences between alatae are often extremely slight in some genera which show however, more obvious differences between the apterae.

For the names of the museums in Leiden and London the original names are used instead of the recently acquired names Nationaal Natuurhistorisch Museum and The Natural History Museum, respectively, for matter of convenience.

### Measurements

The length of the body is measured in the middle from the foremost border to the back border; anteriorly this is usually the frons but in *Glyphinaphis bambusae* sometimes a part ventral to the antennae which is situated dorsally. Protruding horns are not included in the length of the body; the back border of the length is the cauda, but is sometimes the posterior margin of tergite VIII, or the anal plate, or even, as in *Euthoracaphis*, some *Nipponaphis* spp. and *Sinonipponaphis*, the ventral side of some abdominal segments.

Two measurements of the head are used in the description: 1. The width of the head across the eyes, as e.g. in apterae of *Astegopteryx*, and alatae of all species; specimens with the eyes not at horizontal level are not used for measuring. 2. The distance between the outer margins of the eyes is used in apterae of *Cerataphis*, *Glyphinaphis*, *Mesothoracaphis*, *Metanipponaphis*, *Nipponaphis*, and *Sinonipponaphis*.

The length of the antenna is measured in the middle; if the antenna is bent, the length is the sum of e.g. three measurements (fig. a). When measuring segments the membranes are not included (fig. a). The processus terminalis is the distance from the anterior margin of the distal primary rhinarium to the end of the antenna (figs. b, c); accessory rhinaria are not used for this measurement. Because in alatae of Hormaphidinae the distal primary rhinarium cannot usually be distinctly distinguished from the annular rhinaria, the distance from the last annular rhinarium to the end of the antenna is measured.

Horns are measured in the middle (fig. d).

The last rostral segment, segment IV plus V, is measured including the minute setae at the end (fig. e); this unusual measurement is used because the end of the last segment is frequently indistinct; in the Hormaphidinae described these setae add about 4-8  $\mu$  to the length of the last rostral segment. Stylets are measured from the tip of the stylet to the expanded base; when the stylet is measured starting from the end, the fact of whether or not the base is from the same stylet is ignored; of curved stylets the length is the sum of several measurements of subdivisions (fig. f).

The femur plus trochanter is measured as in fig. g, the tibia as in fig. h, the first tarsal segment as in fig. i, and the second tarsal segment as in fig. j.

For the fore wing the ratio of: 1. The distance of the base of the radial sector to the end of the pterostigma at the anterior margin, to 2. The distance from the end of

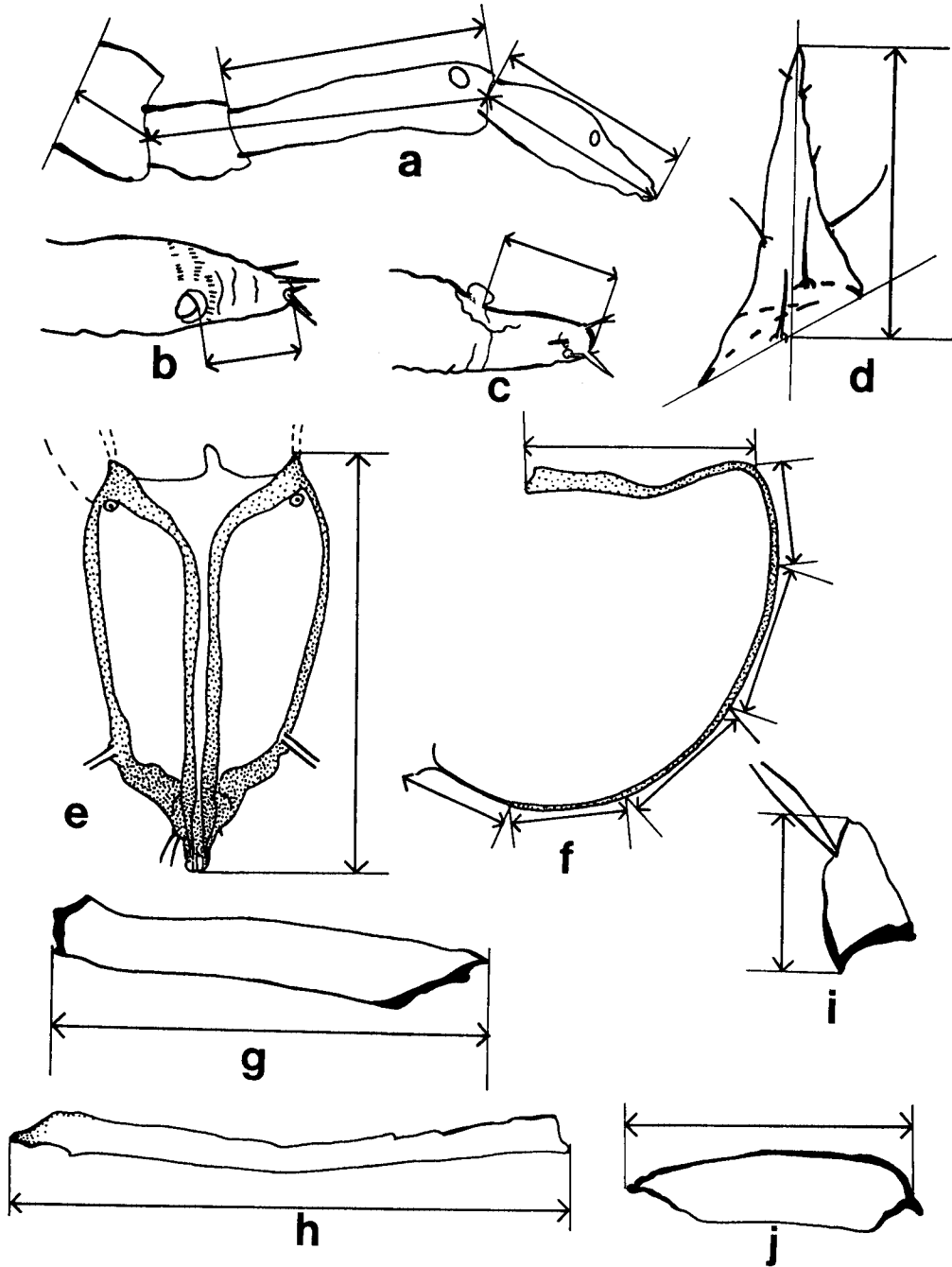

Figs. a-j. Measurements. Fig. a, antenna. Figs. b, c, processus terminalis. Fig. d, horn. Fig. e, last rostral segment. Fig. f, stylets. Fig. g, femur plus trochanter. Fig. h, tibia. Fig. i, first tarsal segment. Fig. j, second tarsal segment.

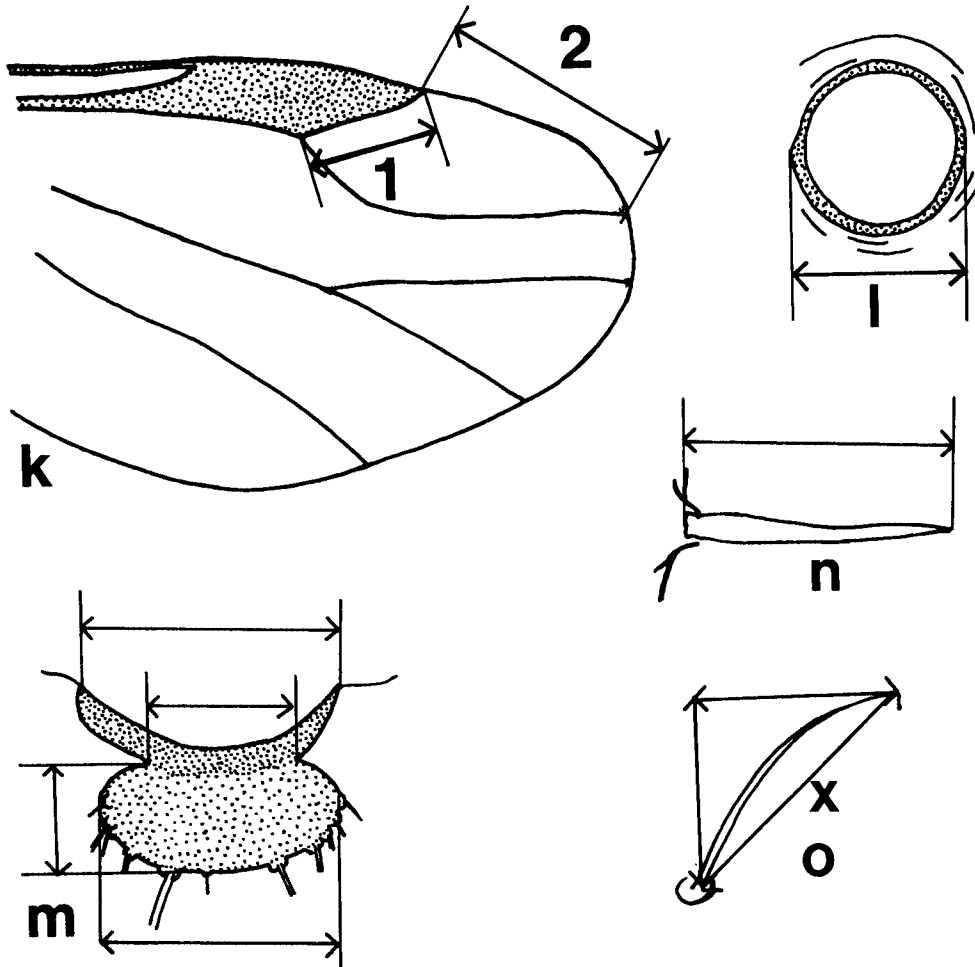

Figs. k-o. Measurements. Fig. k, measurements in order to calculate the ratio of 1 : 2. Fig. l, pore of the siphunculus. Fig. m, measurements of the width of the base of the cauda, of the constriction, of the length of the knob, and the width of the knob. Fig. n, hair on a horizontal surface. Fig. o, hair directed obliquely upwards is considered to be length of the hypotenuse  $x$  of the rectangle indicated.

the pterostigma to the end of the radial sector, as in fig. k is sometimes noted.

The outer diameter of the pore is measured (fig. l). If the pore is distinctly elliptical the mean of the largest and smallest diameter is noted.

Measurements of the cauda, of the width of the base, the width and length of the knob and the diameter of the constriction are as in fig. m.

The length of hairs is measured from the base to the end (fig. n), the width of the hair is measured a short distance distal to the process of the hair; the length of the longest hairs is measured, if other hairs are much shorter, it is expressly mentioned "longest hairs".

Hairs (and e.g. tibiae) which are not on a horizontal surface are measured as in fig. o, assuming the size to be the length of the hypotenuse of a right-angled triangle with sides: 1. The measured length, and 2. The difference in level between the base and the top of the hair.

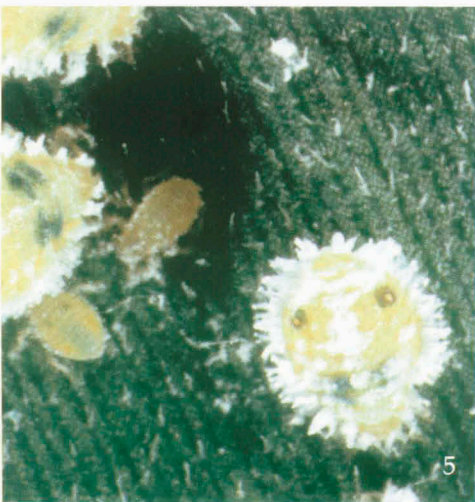
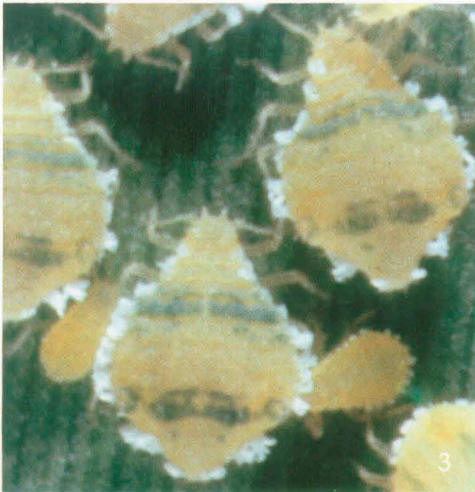
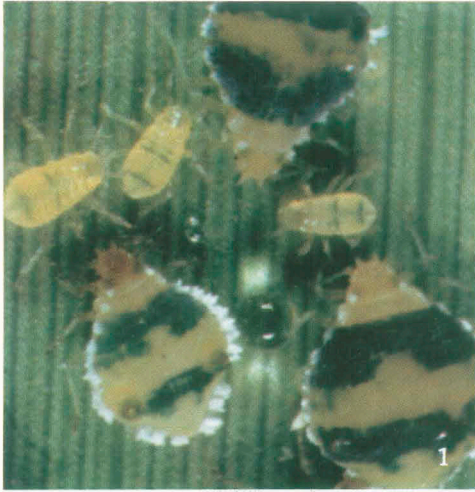

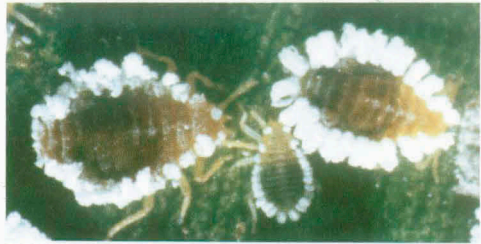
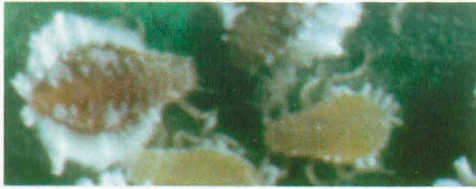
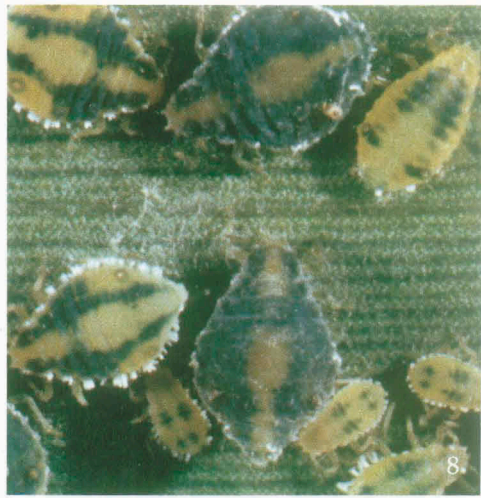
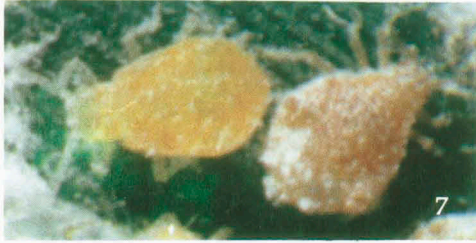



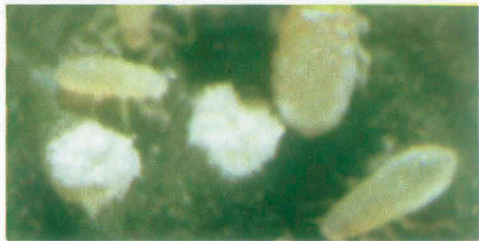
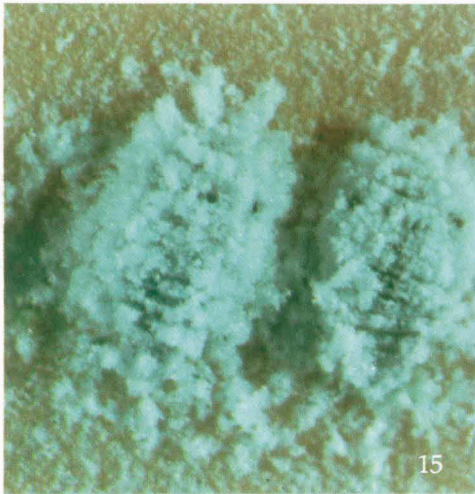
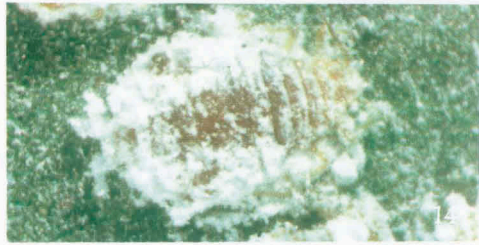
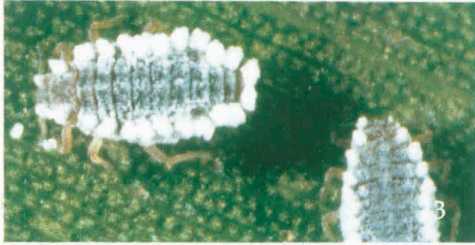
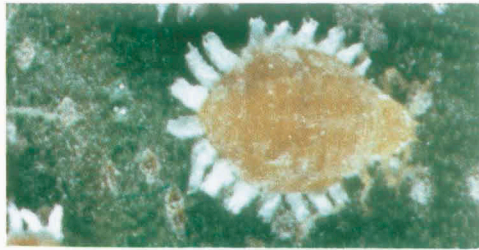
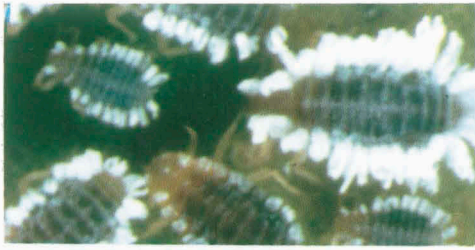

15

17

18

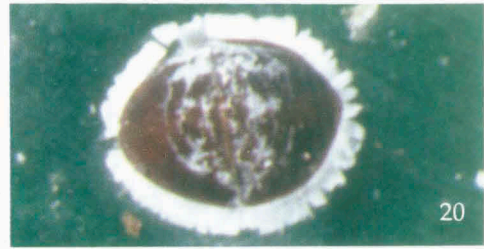
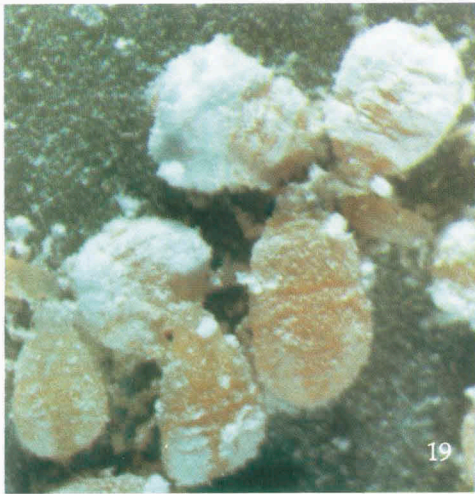

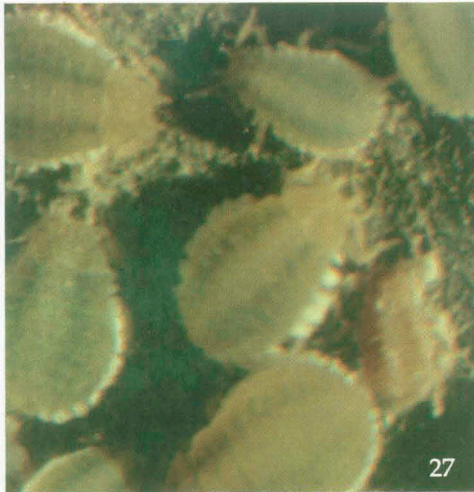

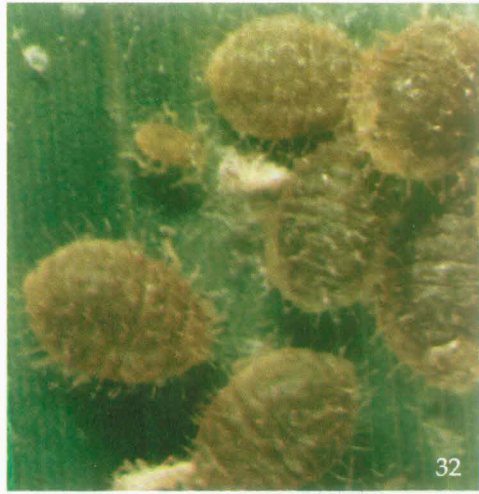

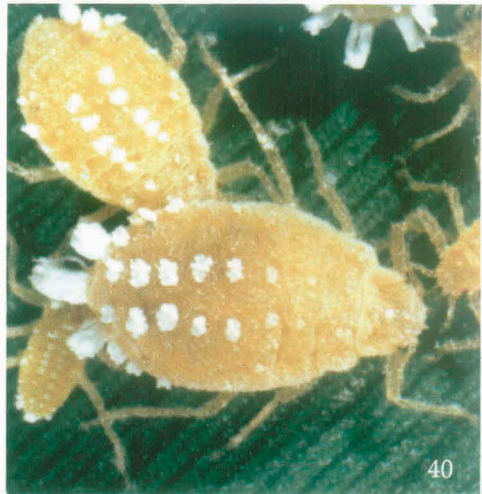
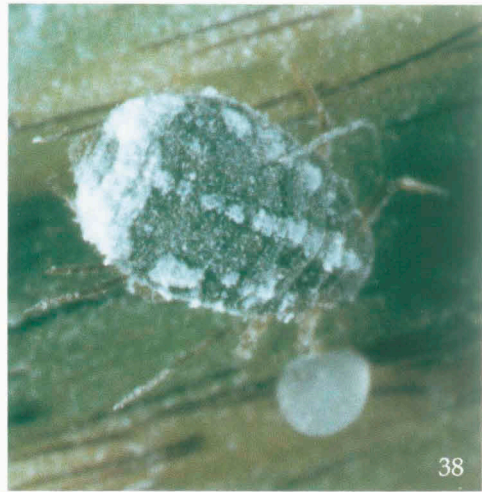

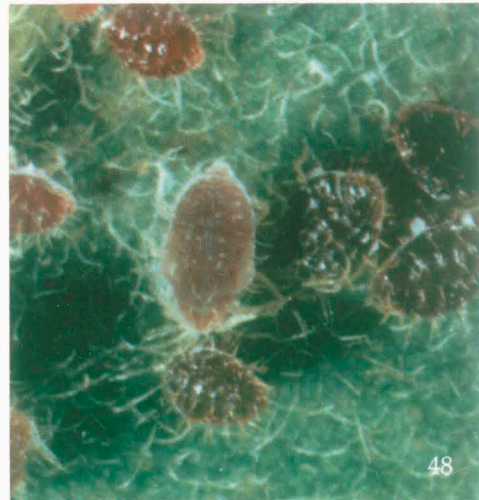
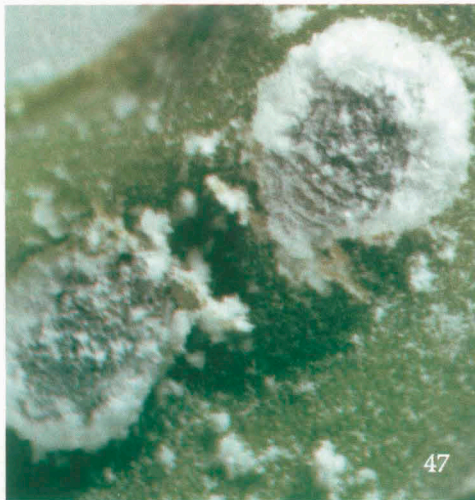

## Captions of plates 1-48

Pl. 1. *Astegopteryx bambusae* (Buckton), colour variety *striata* on a leaf of bamboo, adult apterous viviparous ♀♀ with some larvae. The body yellow, whitish yellow, pale greenish or brownish yellow. A solid patch on metathorax and abdominal segments I-II green, and a second patch around and between the siphunculi also green, which has a continuation pleurally on abdominal segment VII. Wax is present as a fringe at the margin of the head, thorax and abdomen, but is sometimes lacking on the head. Magnification × 22.

Pl. 2. *A. bambusae* (Buckton), colour variety without a name, sometimes occurring in populations of colour variety *lutescens*, without any green. Wax as described above, pl. 1. Magnification × 22.

Pl. 3. *A. bambusae* (Buckton), colour variety *lutescens*. Apterous viviparous ♀♀ on a bamboo leaf. A narrow, fairly indistinct green transversal band on abdominal segment I, and two such bands between the siphunculi. Wax as described above, pl. 1. Magnification × 21.

Pl. 4. *A. bambusae* (Buckton), colour variety *similis*, apterous viviparous ♀♀ on a bamboo leaf. The green similar to *striata*, but around the siphunculi orange-yellow. Magnification × 22.

Pl. 5. *A. bambusae* (Buckton), colour variety *maculata*, apterous viviparous ♀♀ on a bamboo leaf. Has only green spots on metathorax and abdominal segment I and no green on the margins of the body and between the siphunculi. In some collections they occur as small-sized adults, which are present in groups of two or three. For this reason it may be assumed that these adults developed from larvae deposited on the leaves by alatae. The siphunculi if not surrounded by green are usually more ochre-coloured. The wax is much more luxuriant than in the varieties of pls 1-4, and may even be present as a white spinal and pleural line or as transverse bars on several segments. Magnification × 22.

Pl. 6. *A. basalis* (Van der Goot), apterous viviparous ♀♀ on the base of bamboo leaves. Left: the common type in which the adult shows a red, brownish red or blackish red abdomen, while the larvae are yellowish white, and develop the red with age, starting around the siphunculi; magnification × 19. Right: a colour variety exists which is wholly yellow; here a type with only some red around the siphunculi in the adult specimens is shown; magnification × 22.

Pl. 7. *Astegopteryx glandulosa* spec. nov., apterous viviparous ♀♀ on a bamboo leaf. Head, thorax and abdomen yellow, the abdomen with some orange in the shape of two lines in length or as some spots of marbling; the end of the abdomen without orange. Wholly covered with a thin layer of woolly wax, and sometimes thicker bars of wax at the margins of the body, and especially at the end of the abdomen. The leaf is also covered with white powder. Magnification × 21.

Pl. 8. *A. minuta* (Van der Goot), apterous viviparous ♀♀ on the lower side of a bamboo leaf. The body pale yellow, very pale green or dirty white or yellow with two green lines from medial to the eyes up to the lateral sides of abdominal segment VIII. The lines widen to the margins on metathorax, abdominal segments I and II, and in some populations even on all abdominal segments. On metanotum and abdominal segment I the green continues in the middle and shapes a more or less continuous transverse band. Between the siphunculi the lines are also widened to the middle, but usually remain interrupted by a yellow colour in the middle. The siphunculi, and anterior to the siphunculi the body is more orange yellow if not green. Magnification × 22.

Pl. 9. *A. muiri* (Van der Goot) on *Amomum coccineum* (Bl.) K. Schum. (left), and *Alpinia* spec. (right), apterous viviparous ♀♀. The head whitish or pale brown, the body brown, sometimes with a dark violet hue when there is some wax covering the body. The head and prothorax with a column of wax at each side pointing obliquely upwards, the abdomen with thick wax columns marginally on each segment. The dorsum of thorax and abdomen with some wax powder or on every segment with a narrow white transverse band of wax. In *A. nipae* distinct transverse wax bands were not observed. Magnification × 22.

Pl. 10. *A. nipae* (Van der Goot), apterous viviparous ♀♀ on *Cocos nucifera* L. (left), and *Salacca edulis* Reinw. (right). Head, antennae, legs and end of the abdomen yellow or pale brown. Abdomen brown or brownish red, frequently darker around the siphunculi. Head and prothorax with two columns of wax each, pointing obliquely upwards. Margins of each thoracic and abdominal segment with a column of wax. The dorsum looks dull and is sometimes covered with white wax powder. Magnification × 22.

Pl. 11. *A. pallida* (Van der Goot), apterous viviparous ♀♀ on bamboo. Left: body yellow with a pair of green spots on mesonotum, metanotum and abdominal segments I-II, the pleural and spinal parts of these segments are yellow. On segments IV-V, medial to the siphunculi green spots are present, and smaller ones sometimes also on segments VI-VIII. Small columns of wax may be present marginally on the abdominal segments, and sometimes only on segments VII-VIII. This is the most commonly seen type of *A. pallida*. Right: the green pattern about as in the left plate, but plentiful wax present on the head, the margins of the thorax and abdominal segments, and pleurally and sometimes also

spinally on all segments of the body. Specimens like these are found separately or in small groups on the lower side of a leaf. Magnification  $\times 22$ .

Fig. 12. *A. pallida* (Van der Goot), apterous viviparous ♀♀ on the lower side of a bamboo leaf. The whole body dark bluish green, except for the head, the margins of abdominal segments VI, I-IV, and thorax, and a longitudinal oval spot spinally on abdominal segments III-VI, which remain yellow. The wax decreases in proportion as the green increases, remaining the longest on the last abdominal segments, but there also all wax may disappear. Magnification  $\times 22$ .

Pl. 13. *Astegopteryx rappardi* Hille Ris Lambers, on the lower side of leaves of *Cocos nucifera* L., apterous viviparous ♀♀. Head, legs, anterior part of the thorax and end of the abdomen brown or due to the presence of wax brownish red or dark violet. The length of the wax fringe varies greatly. The dorsum is sometimes smooth, showing either a few segmental transverse patches, or is covered with some white wax powder. The body is more oblong than in *A. nipae*, and the marginal wax gland groups of abdominal segments I-IV are located somewhat closer to the middle. Magnification  $\times 19$  (left), and  $\times 22$  (right).

Pl. 14. *A. rhapsidis* (Van der Goot), apterous viviparous ♀♀ on the lower side of leaves of *Cocos nucifera* L. Colour of the body pale brown, brownish yellow or brown, even with brown transversal bands or brown marbling or longitudinal bands. Specimens in younger populations with a wax fringe which is longest on abdominal segment VIII, and short on head and thorax. pl. 15 shows specimens of an old population, which look as though they are covered with snow. The small columns of wax marginally on head and thorax distinguish *A. rhapsidis* from *A. nipae*, and a wax cover resembling snow was never seen in *A. nipae*. Magnification  $\times 22$ .

Plate 15. *A. rhapsidis* (Van der Goot), apterous viviparous ♀♀ on the lower side of a leaf of *Cocos nucifera* L. The adults look as though they are covered with snow, and there are sometimes thick flocks of wax on the dorsum and the margins, and a layer of flakes on the leaf. Magnification  $\times 22$ .

Pl. 16. *A. setigera* spec. nov., apterous viviparous ♀♀ inside a flower gall of *Styrax benzoin* Dryand. The body is pale yellow, with a fine granular, flaky wax, the margins of the abdomen with a thick cushion, also where there are siphunculi. Magnification  $\times 23$ .

Pl. 17. *A. singaporensis* (Van der Goot), apterous viviparous ♀♀ on the lower side of bamboo leaves. The body is yellowish white or very pale brownish yellow. Very pale green spots are present on the body but there is never any green in the median area. Usually two spots are present on abdominal segment I, and another pair on the metathorax; in some collections there was also a pair of spots on the mesothorax. Rarely, a barely distinguishable pair of green spots is seen on abdominal segments IV and V. The siphunculi are bright yellow or brownish yellow. A fringe of wax may occur at the margin of head, thorax and abdomen, but was lacking on thorax and several abdominal segments in some collections. An accumulation of wax sometimes occurs in the median area of thorax and abdominal segments I-IV. Magnification  $\times 22$ .

Pl. 18. *A. unimaculata* spec. nov., apterous viviparous ♀♀ on the lower side of a bamboo leaf. The body is pale yellow or pale greenish yellow. One closed bluish green patch without interstices covers the body from metathorax to the distal margin of abdominal segment V or to the anterior margin of VI. From a distance the aphids appear as a blue green spot encircled by a white ring. Wax marginally on head and all thoracic and abdominal segments. Magnification  $\times 22$ .

Pl. 19. *Cerataphis fransseni* (Hille Ris Lambers), apterous viviparous ♀♀ and an alata larva inside a gall of *Styrax benzoin* Dryand. The body orange-yellow, covered with a thick layer of wax, which may be spread when the aphids walk about. Magnification  $\times 22$ .

Pl. 20. *C. freycinetiae* (Van der Goot), apterous viviparous ♀, adult and larva on a leaf of *Freycinetia funicularis* (Savigny) Merr. Magnification  $\times 23$ .

Pl. 21. *C. lataniae* (Boisduval), apterous viviparous ♀♀, adults and part of a larva on a leaf of *Cocos nucifera* L. Body shiny brown or orange-brown, segments observable by a slight reflection of the vaulting of each segment. A flat, horizontal white fringe of wax along the border of the body, almost without any interruption. Magnification  $\times 22$ .

Pl. 22. *C. palmae* (Ghesquière), apterous viviparous ♀♀, adults and larvae on a leaf of *Cocos nucifera* L. Body blackish brown, usually dull, but sometimes shiny, with a white transverse line between metanotum and abdominal segment I, and sometimes also between abdominal segments I and II. If the dorsal wax cover is damaged some other white patches may be seen. A flat, horizontal white fringe of wax along the border of the body, up to 0.35 mm wide, without any interruption on the body, with several slits at the border. Magnification  $\times 22$ .

Pl. 23. *C. pothophila* spec. nov., apterous viviparous ♀♀ and an alata larva on the lower side of a leaf of *Pothos roxburghii* de Vriese. Body brownish black, dull, covered with a thin layer of small wax hairs, a



white transverse line in the middle. A flat horizontal white fringe of wax along the border of the body, up to 0.25 mm wide, without any interruption on the body, with several slits at the border. Magnification  $\times 23$ .

Pl. 24. *Ceratoglyphina bambusae* Van der Goot, apterous viviparous ♀, adult and larva, on the inner side of a young sheath of *Schizostachyum* spec. Body dull brown, blackish brown or marbled dark greenish black, frequently the anal plate is visible, a brighter brown than segment VIII. A median line on head and thorax is whitish due to wax, and also transversely some wax at the borders of the thoracic segments. A flat fringe of wax up to 0.2 mm wide from the posterior part of the prothorax to the margins of abdominal segment VIII, lacking around the head and at the posterior margin of abdominal segment VIII. Magnification  $\times 22$ .

Pl. 25. *Ceratoglyphina bambusae* Van der Goot, apterous viviparous ♀, adult and larva, on the inner side of a young bamboo leaf. As pl. 24, but the adult dark greenish black. Magnification  $\times 23$ .

Pl. 26. *C. bambusae* Van der Goot, apterous viviparous ♀, adult and larvae on the inner side of a sheath of a young sprout of *Schizostachyum zollingeri* Steud. Description see pl. 24. Magnification  $\times 22$ .

Pl. 27. *C. bengalensis* L.K. Ghosh, apterous viviparous ♀, on the pl. only larvae, on the border of the sheath and the base of a leaf of a young bamboo sprout. Head and body of adult apterae are pale brown, sometimes with two longitudinal bands vaguely observable. A narrow, flat fringe at the posterior part of the prothorax to the margins of abdominal segment VIII. Larvae as adult, but the green of the body more bright, and the longitudinal bands more distinct. Magnification  $\times 19$ .

Pl. 28. *Ceratovacuna lanigera* Zehntner, apterous viviparous ♀ on a leaf of *Saccharum officinarum* L. The head brownish, the abdomen pale yellow with pale brown spots or stripes. The head with some granular wax, the rest of the body with a thick cushion of wax, and especially the margins and the back of the body with thick curling white threads. Magnification  $\times 20$ .

Pl. 29. *C. panici* (Van der Goot), apterous viviparous ♀♀, adults and larvae on a leaf of *Microstegium ciliatum* (Trin.) A. Camus. The body yellow or somewhat brownish, densely covered with wax, resembling snow flakes, the borders of the segments remain visible rather a long time; the borders of the body with compact columns of wax, shorter than sometimes seen in *C. lanigera*. Magnification  $\times 19$ .

Pl. 30. *Distylaphis foliorum* (Van der Goot), apterous viviparous ♀♀ on a leaf of *Distylium stellare* O.K. On the pl. larvae only. Larvae bright greenish with flocky wax especially at the margins of the body. Magnification about  $\times 3$ .

Pl. 31. *Glyphinaphis bambusae* Van der Goot, apterous viviparous ♀♀ on the lower side of a developing top leaf of bamboo. Body dull green, pale to greenish brown, or brown, somewhat shiny, with transversal grooves due to three segmental borders, with 4-6 longitudinal rows of hairs, but sometimes the hairs are less distinct. Antennae, legs and the lower side of the body floury, the dorsal side without distinct wax. Magnification  $\times 23$ .

Pl. 32. *G. bambusae* Van der Goot, apterous viviparous ♀♀, adults and larvae on the border of sheath and leaf blade. Description see pl. 31. Specimens of this collection brown. Magnification  $\times 23$ .

Pl. 33. *Mesothoracaphis rappardi* (Hille Ris Lambers and Takahashi), apterous viviparous ♀♀ on a lignified branch of *Dendrophthoe pentandra* (L.) Miq.. Body a brownish black box, dorsally somewhat shiny, with four transverse furrows; the margins perpendicular, dull, white, similar to hoar frost. Cauda and subanal plate pale brown, the last segment in front of these dark reddish brown. Magnification  $\times 22$ .

Pl. 34. *Nipponaphis brevopilosa* spec. nov., apterous viviparous ♀♀ on a twig of *Castanopsis argentea* (Bl.) DC. The body brown, borders of abdominal segments II-VII yellowish. The prosoma vaulted with transverse deep furrows with distinct pits of intersegmental muscular plates. The body is covered with a transparent, but not shiny, layer of wax. Two pairs of spots of white wax on the sides of the body, between fore- and midleg, and between mid- and hind leg. Magnification  $\times 22$ .

Pl. 35. *N. javanica* spec. nov., part of an apterous viviparous ♀ at the top of the pl., the other specimens are larvae of alatae, on a young sprout of *Castanopsis acuminatissima* (Bl.) A. DC. The body brownish, with some wax powder, but furrows and segmental swellings distinctly observable. Magnification  $\times 22$ .

Pl. 36. *N. semiglabra* spec. nov., apterous viviparous ♀♀ on older twigs of *Lithocarpus bennettii* (Miq.) Rehd. The body brown with a slightly paler band marginally from head to the complex of segments II-VII, and two paler transverse lines on the body. Two black spots on the prothorax, and three rows of four black spots on mesothorax to abdominal segment I. Posterior area of the complex of segments II-VII darker than the anterior part. Dorsal side covered by a smooth transparent layer of wax, which only looks whitish when damaged. On each side two spiracula visible as small buttons with white wax. Magnification  $\times 22$ .

Pl. 37. *Pseudoregma bambusicola* (Takahashi), apterous viviparous ♀, two larvae, the whole population on the base of a bamboo leaf. The larvae show the abundant development of wax, characteristic of

new starting populations: at each side of the body 11 columns of wax, from head to abdominal segment VII, and a longitudinal band of wax columns from the pronotum spinally to spinally on abdominal segment VIII; this wax is connected with wax gland groups as shown in figs. 395 and 385. Pleurally, anterior to the siphunculi as far as the mesothorax wax columns are present, and this wax is connected to s-shaped wax glands. fig. 385a. Magnification  $\times 23$ .

Pl. 38. *P. bambusicola* (Takahashi), apterous viviparous ♀ on a young bamboo culm, one specimen from a rather large population. Marginal wax columns only here and there and tiny; spinally and anterior to the siphunculi are tufts of rather granular wax, and the posterior part of the abdomen is covered with a thick cushion of wax; the rest of the body is grey due to a wax whitish powder. The marginal wax must be connected to groups of wax glands, but all other wax to s-shaped wax glands as pustules as in figs. 385a and 388. Magnification  $\times 22$ .

Pl. 39. *P. bambusicola* (Takahashi), two apterous viviparous ♀♀ with on top of them two soldiers, on a bamboo culm. Pleural and spinal tufts of wax are almost lacking, and a thick cushion of wax is only present on the posterior abdominal segments, the characteristic appearance of specimens in old, large populations with alatae. Magnification  $\times 22$ .

Pl. 40. *P. montana* (Van der Goot), apterous viviparous ♀ on the lower side of a bamboo leaf. The body yellowish violet or purple-brown, dusted with wax powder but the colour of the body shows through. Columns of wax, observable as white dots in marginal rows on the thoracic segments and on abdominal segments I-VII. Spinally two rows of columns from head to abdominal segment VI, lacking on VII, and only one column on VIII. The specimen shows little wax on the anterior part of the body, but in young populations on the lower side of the base of a leaf the specimens show columns of wax also on head and thorax. Magnification  $\times 22$ .

Pl. 41. *P. panicola* (Takahashi), apterous viviparous ♀♀ on an internode of *Cyrtococcum accrescens* (Trin.) Stapf. The body brownish black, blackish brown or violet brownish red, covered with short or long columns of wax present marginally and in two spinal longitudinal lines, while granular wax is present everywhere between the columns. Magnification  $\times 22$ .

Pl. 42. *P. pendleburyi* (Takahashi), apterous viviparous ♀, an adult and two larvae on a developing culm of *Schizostachyum blumii* Nees. Body blackish brown, marbled. Small columns of wax may be present on each of the thoracic segments and on abdominal segments I-VI marginally and in two rows spinally; small wax columns from mesothorax to abdominal segment VI may constitute a fifth and sixth row of wax. Between the columns of wax the body is covered with a dull granular layer of wax, which breaks into white scales when pressed. Magnification  $\times 22$ .

Pl. 43. *Pseudoregma sundanica* (Van der Goot), apterous viviparous ♀♀ on the petiole at the base of the leaf blade of *Catimbum malaccensis* (Burm.f.) Holtt. Body blackish brown or black, but the last abdominal segments paler. The specimen shown is from a rather young, small population, showing distinct columns of wax, marginally, pleurally, and in two spinal longitudinal rows; spinally on abdominal segment VII columns of wax are lacking, and on VIII one column is present. Marginal and spinal wax is connected to wax gland groups, fig. 424, and the pleural columns to s-shaped wax glands. Magnification  $\times 22$ .

Pl. 44. *P. sundanica* (Van der Goot), apterous viviparous ♀♀ with soldiers on the base of the main vein of the leaf. Specimens of old populations with alatae and soldiers. Description see pl. 43. The specimens have only a few tufts of wax, but the body is covered with a wax layer, outside with a granular appearance; when pressed the wax layer breaks into white scales. In specimens of collections not shown here pleurally a thick cushion of wax may be present. Magnification  $\times 22$ .

Pl. 45. *Rappardiella cerina* spec. nov., apterous viviparous ♀♀ on a leaf of *Dendrophthoe pentandra* (L.) Miq. Body yellowish white with a soft mixture of reddish brown. The body, antennae and legs covered with a dull, but transparent layer of wax; this layer turns white when broken. Magnification  $\times 22$ .

Pl. 46. *R. loranthi* (Van der Goot), apterous viviparous ♀♀ on a leaf of *Scurrula korthalsii* (Molkenb.) Dans. The body orange, sometimes more violet, with on each segment three or four darker patches, which disappear in alcohol. The body is covered with a rather thin granular to flaky cover of wax, not covering segmental borders; along the border of the body from head to about the siphunculi tiny columns of wax, no higher than 50  $\mu$ . Magnification  $\times 22$ .

Pl. 47. *R. macrosoleni* spec. nov., apterous viviparous ♀♀ inside a leaf gall of *Macrosolen cochinchinensis* (Lour.) Tiegh. The body brown, covered with a thin layer of flaky wax; a horseshoe-shaped cushion passes the border from metathorax and around the last abdominal segment, up to 0.5 mm wide, even covering the siphunculi, but sometimes interrupted spinally and more narrow on the last abdominal segment. Magnification  $\times 22$ .

Pl. 48. *Schizoneuraphis gallarum* Van der Goot, apterous viviparous ♀♀ and one alate larva on a leaf of *Litsea glutinosa* (Lour.) C.B. Robins. The body shiny dark brown or black. The almost perpendicular sides just ventral to the rather flat dorsum with a white band of wax, which widens to the ventral side between fore- and midleg, and between mid- and hind leg to a small column of wax. The dorsum with upright pale brown hairs, and rather indistinct patches of wax. Magnification  $\times 22$ .

### Keys to the genera

#### Key based on apterae

1. Apterae from flower- or leaf-galls of *Styrax* .....2
  - Apterae not from *Styrax* galls ..... 3
2. Stylets 180-200  $\mu$  long. Head ventrally with four spines or with more than eight; abdominal segment VII dorsally with two hairs, VI with 2-3. First tarsal segments of the midleg with 3-4 hairs ..... *Astegopteryx*
  - Stylets 260-300  $\mu$  long. Head ventrally in the middle with two spines, 13-22  $\mu$  long, next to 4-5 smaller spines or hairs. First tarsal segments of the midleg with four hairs ..... *Cerataphis*
3. Apterae not from leaves or galls of *Distylium* ..... 4
  - Apterae on leaves or from galls of *Distylium*. The head fused with the pronotum only, and without horns, and without hairs shorter and thicker than normal hairs .....20
4. Head fused with the pronotum or also with meso- and metanotum, but not with abdominal segments (Cerataphidini) ..... 5
  - Head fused with thoracic segments and at least also with abdominal segment I, or with segments I-VII (Nipponaphidini) ..... 12
5. Meso- and metanotum fused, and a distinct furrow posterior to the pronotum and also to the metanotum. Frontal horns or dagger hairs are lacking ..... 6
  - Segments of meso- and metanotum sclerotic and fused, without a furrow posterior to the pronotum; or segments of meso- and metanotum and abdomen more or less discernible. Frontal horns, dagger hairs or thicker ventral hairs present ..... 7
6. Abdominal segments I-VII fused. A row of wax glands marginally along the head, thorax and abdomen. Marginal and dorsal hairs 10-15  $\mu$  long. The last rostral segment 2.0-2.4 times as long as the second tarsal segment of the hind leg ..... *Aleurodaphis*
  - Abdominal segment I free, with a furrow posterior to the metanotum and anterior to abdominal segment II. A row of marginal wax glands is lacking. Marginal and dorsal hairs 30-200  $\mu$  long. The last rostral segment 0.6-0.9 times as long as the second tarsal segment of the hind leg ..... *Glyphinaphis*
7. Body disc-shaped, sclerotic with a furrow only posterior to the metanotum, and one posterior to abdominal tergite VII. Circumference usually with a continuous row of wax glands. Head ventrally usually with two horns without hairs ..... *Cerataphis*
  - Body with a furrow posterior to the pronotum. Marginal wax glands frequently present but with a space between the segments. The frons with two horns with four or more small hairs, or the head ventrally with some hairs with a wider base than normal ..... 8
8. Cauda and anal plate without a constriction or incision. Length of the head plus pronotum 0.45-0.57 times as long as the width of the pronotum. The head ventrally with 18-43 hairs. Marginal wax glands only, linearly arranged. Horns on the head with 8-18 hairs ..... *Ceratoglyphina*
  - Cauda with a constriction, anal plate bilobed. Length of the head plus pronotum 0.6-0.8 times as long as the width of the pronotum. Other characters varying .....9
9. The head ventrally with two horns which bear one hair on top, or horns are lack-

- ing, but 2-5 hairs are present, which are thicker and shorter than the other hairs. All species living on Loranthaceae ..... *Rappardiella*
- Frons with two horns bearing four or more hairs, which are small at the top of the horn, but at the base of the horn sometimes larger. All ventral hairs of a normal shape ..... 10
10. Two elongate oval swellings with pustules along the posterior margin of the pronotum, one on each side of the median line, falling sharply, especially at the anterior and posterior sides. Length of the stylets 230-545  $\mu$ . Length of the longest hairs of the cauda 57-120  $\mu$ , of the anal plate 55-116  $\mu$ . Wax glands on the spinal area present in five of the six species. Area around the pore of the siphunculi brown over a width of more than 12  $\mu$ , in some species with hairs *Pseudoregma*
- The area along the posterior margin of the pronotum smooth or almost smooth, without swellings which fall sharply at the anterior and posterior side. Length of the stylets 195-322  $\mu$ . Length of the longest hairs of the cauda 23-80  $\mu$ , of the anal plate 35-84  $\mu$ . Other characters varying ..... 11
11. Siphunculi with a cone provided with 2-28 hairs. Spinal wax glands lacking or only present on the head and abdominal tergite VIII, in number of 0-8, and 0-9 respectively ..... *Astegopteryx*
- Siphunculi without a cone, or a cone which extends around the pore at the most 10-20  $\mu$ , and is never provided with hairs. Spinal wax glands sometimes present, in numbers of 0-13 on the head, and 5-40 on abdominal tergite VIII ..... *Ceratovacuna*
12. Siphunculi lacking. The prosoma and the abdominal tergites II-VII reticulated. Body 500-850  $\mu$  long, with a prosoma separated from the abdominal complex II-VII, with marginal hairs, 75  $\mu$  long and acute, or 40  $\mu$  long, blunt and curved, or less than 10  $\mu$  long. On *Ficus* ..... *Reticulaphis distyllii*
- Siphunculi present. Dorsum not reticulated, or only the muscle plates show some reticulation. Other characters varying ..... 13
13. A furrow between the prosoma and abdominal tergites II-VII is lacking, also at the margins ..... 14
- A furrow between the prosoma and abdominal tergites II-VII is present, but sometimes only distinct at the margins ..... 15
14. The body densely covered dorsally and on the sides with hair-like processes, 15-40  $\mu$  long, which are lacking on the muscle plates and on the tergites of abdominal segments II or III to VIII. Dorsal hairs are lacking on abdominal segments II-VII, and marginally presumably on IV and V ..... *Sinonipponaphis*
- Hair-like processes are lacking on the body. Dorsal hairs on what corresponds to segments I and II are present, two on each; and marginally seven hairs on each side which correspond to each of the abdominal tergites I-VII. Caudal to the posterior spinal hairs are denticulate imbrications, pustules are lacking there. On *Quercus* ..... *Neohormaphis*
15. The meso- and metanotum in the middle with ridges arranged in two longitudinal lines, 150-220  $\mu$  apart, the area in between usually sunk 10-40  $\mu$ . Margin of the prosoma radially striped, the stripes 20-70  $\mu$  long. Marginal hairs 70-80  $\mu$  from the margin of the prosoma, 141-208  $\mu$  long. Knob of the cauda roundish, almost as long as it is wide. The abdominal complex II-VII with marginal, pleural and medial hairs. Antennae 80-110  $\mu$  long. Larvae with roundish wax glands with a

- diameter of 2-4  $\mu$  arranged marginally in longitudinal bands and dorsally in oval areas. On *Quercus* ..... *Thoracaphis*
- Medial part of the meso- and metanotum not sunken below the lateral part. Margin of the prosoma without stripes. Knob of the cauda usually wider than long. Other characters varying ..... 16
16. Dorsal hairs 120-170  $\mu$  long, and near the base 7-10  $\mu$  thick; sometimes smaller hairs next to these stout hairs. Length of the body 685-875  $\mu$ . On *Litsea* .....  
..... *Schizoneuraphis*
- Dorsal hairs 15-120  $\mu$  long, near the base not more than four  $\mu$  thick. Length of the body 950-1800  $\mu$  ..... 17
17. The prosoma brown, with a trapeziform area which is separated from other parts by colourless sutures: anteriorly from the pronotum, posteriorly from the abdominal tergites complex II-VII, and at the sides from the marginal areas. On *Cinnamomum* ..... *Euthoracaphis*
- A trapeziform area on the prosoma is lacking ..... 18
18. Abdominal tergite VIII with two hairs. The prosoma at the posterior side not separated from the complex of abdominal segments II-VII by a furrow, only a distinct marginal furrow present. The prosoma with pustules, observable as half rings or ellipses at a distance from each other of 6-12  $\mu$ ; near the margins of the plate a pattern somewhat like pieces of a jigsaw puzzle. Length of marginal hairs of the complex of abdominal tergites II-VII, 12-25  $\mu$ . On *Lithocarpus* .....  
..... *Metanipponaphis*
- Abdominal tergite VIII with 3-10 hairs. The prosoma at the posterior side separated from the complex II-VII; this furrow sometimes lacking spinally. Length of marginal hairs of the complex II-VII in one species 14-39  $\mu$  long, in other species longer ..... 19
19. Antennae 76-90  $\mu$  long, 0.07-0.09 times as long as the body. On each of the thoracic segments spinally 3-7 hairs, and sometimes one hair spinally on abdominal segment I, on the complex of abdominal segments II-VII spinally hairs are lacking. Prosoma almost smooth, finely punctated, but with three medial transverse folds with some pustules. On Loranthaceae ..... *Mesothoracaphis*
- Antennae 202-279  $\mu$  long, 0.13-0.22 times as long as the body. The dorsum with many pustules or almost smooth, but if smooth than spinally on abdominal segment I, 10-15 hairs. On *Castanopsis*, *Lithocarpus*, and *Ficus* ..... *Nipponaphis*
20. Last rostral segment 53-55  $\mu$  long, 1.36-1.45 times as long as the second tarsal segment of the hind leg. Length of the tibia of the fore leg 106-116  $\mu$ , of the second tarsal segment of the hind leg 38-40  $\mu$ . Length of hairs of the cauda 22-25  $\mu$ , of the anal plate 28-31  $\mu$  ..... *Neohormaphis*
- Length of the last rostral segment and of the fore tibia and second tarsal segment of the hind leg different, or the length of hairs of cauda and anal plate different ...  
..... 21
21. Separate circular wax glands with a diameter of 2-3  $\mu$  in areas on the head thorax and abdomen, or on the abdomen only. Length of the body 1.3-2.0 mm .....  
..... *Distylaphis*
- Wax glands arranged in convolutions or sinuate lines, or rather indistinct. Length of the body 800-1300  $\mu$  ..... 22
22. Second tarsal segments dorsoapically with stout hairs, 35-40  $\mu$  long, with

- expanded tips, 3-5  $\mu$  wide. Linear or indistinct wax glands. Lateral hairs of the first tarsal segment of the fore leg absent in the fundatrix, but in next generations 2.2 times as long as the middle hair ..... *Reticulaphis*
- Hairs on second tarsal segments 15-28  $\mu$  long, and not expanded at the tips. Wax glands arranged in convolutions, or linear and then some hairs on head and thorax 100-175  $\mu$  long. Lateral hair of the first tarsal segment of the fore leg 0.37-1.08 times as long as the middle hair ..... *Schizoneuraphis*

### Key based on alatae

1. Anterior cephalic horns are present figs. 13, 28 or, if absent, 6-15 small hairs, 4-10  $\mu$  long on two areas lateral to the median ocellus figs. 38, 57. Or horns lacking, but 30-40 small hairs also present in the median area, fig. 124 ..... 2
- Anterior cephalic horns are lacking, and anterior to the paired ocelli only 8-10 normal hairs are present, or next to these 2-6 rather short hairs with broader bases, but 6-15 small hairs on two areas lateral to the median ocellus are lacking .  
.....5
2. Subanal plate entire, ventrally in the middle only curved inwards with about 40-65 hairs. Longest hairs on the horns 20-50  $\mu$ , the horns 35-130  $\mu$  long .....  
.....*Ceratoglyphina*
- Subanal plate bilobed, with 12-28 hairs. Hairs on horns, if horns are present, at the most 15  $\mu$  long, length of the horns 0-65  $\mu$  .....3
3. Length of the pterostigma from the base of the radial sector to the anterior margin of the fore wing (fig. k, 261, 274) 0.5-0.8 times the distance from the end of the pterostigma to the end of the radial sector. Siphunculi a ring only or a pale brown zone of about five  $\mu$  outside the pore, and without hairs near to the pore .....  
.....*Ceratovacuna*
- Length of the pterostigma from the base of the radial sector to the anterior margin of the fore wing frequently 1.0-1.4 times the distance from the end of the pterostigma to the end of the radial sector. Siphunculi frequently a cone with hairs ..... 4
4. Length of the femur of the hind leg 460-582  $\mu$ . Length of the stylets 244-518  $\mu$ . Length of the empodial hair of the second tarsal segment of the hind leg 27-47  $\mu$ . Second tarsal segment of the hind leg with at the most one dorsoapical hair expanded at the tip, that hair 45-76  $\mu$  long. The subgenital plate with 6-19 anterior hairs ..... *Pseudoregma*
- Not agreeing with one or more of these five characters, but: length of the femur of the hind leg 322-456  $\mu$ . Length of the stylets 185-283  $\mu$ . Length of the empodial hair of the second tarsal segment of the hind leg 23-34  $\mu$ . Second tarsal segment of the hind leg with 1-2 dorsoapical hairs expanded at the tip, length of these hairs 39-57  $\mu$ . The subgenital plate with 4-7 anterior hairs ..... *Astegopteryx*
5. Antennae with four segments. Body with short setae (Van der Goot, 1917) .....  
.....*Glyphinaphis*
- Antennae with five segments. Body with short or long setae ..... 6
6. Last rostral segment 190-195  $\mu$  long, 2.0-2.4 times as long as the second tarsal segment of the hind leg. Stylets 700-765  $\mu$  long ..... *Aleurodaphis*

- Last rostral segment 53-118  $\mu$  long, 0.63-1.18 times as long as the second tarsal segment of the hind leg. Stylets 235-510  $\mu$  long ..... 7
- 7. Cauda without a median process. Length of the body 1.3-2.4 mm ..... 8
- Cauda transverse cone-shaped, sometimes with a median process. Length of the body 2.7-3.3 mm ..... 12
- 8. First tarsal segments of the fore leg with four hairs. Siphunculi with 2-10 hairs. On the head ventrally sometimes 2-6 hairs with a broader base than other hairs and fairly short small dagger hairs. Second tarsal segment of the hind leg apically with 1-2 hairs with expanded tips ..... 9
- First tarsal segments of the fore leg with three hairs. Siphunculi with 0-1 hair. The head ventrally without dagger hairs or broader bases of some hairs ..... 13
- 9. First tarsal segment of the midleg with three rarely with four hairs. Subgenital plate with 3-10 anterior hairs ..... 10
- First tarsal segment of the midleg with four hairs. Subgenital plate with 2-3 anterior hairs ..... 11
- 10. The cauda with a knob or broadly rounded, with 4-19 hairs, the longest 40-78  $\mu$ . Antennal segment III, 1.6-3.8 times as long as V. Abdominal tergite VIII, with 4-10 hairs ..... *Cerataphis*
- The cauda broadly rounded, with 10-13 hairs, the longest 26-39  $\mu$ . Antennal segment III, 1.9-2.3 times as long as V. Abdominal tergite VIII with 6-10 hairs .....  
.....*Rappardiella macrosoleni*
- 11. Length of the stylets 270-510  $\mu$ . Cauda broadly rounded or with a knob, with 8-13 hairs, the longest 26-69  $\mu$ . Antennal segment III with 23-49 rhinaria, IV with 7-15, V with 1-13. Length of the body 1.3-2.0 mm, of the tibia of the hind leg 456-740  $\mu$  .....*Rappardiella*
- Length of the stylets 235-255  $\mu$ . Cauda broadly rounded, with 15-23 hairs, the longest 40-53  $\mu$ . Antennal segment III with 15-21 rhinaria, IV with 3-6, V with 1-4. Length of the body 1.4-1.6 mm, of the tibia of the hind leg 425-464  $\mu$  .....  
.....*Cerataphis fransseni*
- 12. Antennal segment III, 2.8 times as long as IV, and IV, 0.8 times as long as V; segment III with 17 rhinaria, IV with seven, V with eight. The gonapophyses two, each with six small spines (Van der Goot, unpublished). No specimen available. From leaves of *Quercus* ..... *Thoracaphis arboris*
- Antennal segment III, 1.9-2.6 times as long as IV, and IV, 1.0-1.1 times as long as V; segment III with 20-25 rhinaria, IV with 9-12, V with 7-10. Gonapophyses two, each with 6-8 hairs, 35  $\mu$  long. From galls of *Distylium stellare*; the embryos in the alatae are exactly like first stage larvae of apterae living on leaves of *D. stellare* .....  
.....*Distylaphis foliorum*
- 13. Media of the fore wing unbranched, united with the cubitus, and these again with the anal vein. Cauda with 4-6 hairs, 18-23  $\mu$  long. From galls on the upper side of leaves of *Distylium stellare*; the alatae with embryos exactly like first stage larvae of apterae living on leaves of *Quercus* ..... *Neohormaphis calva*
- Media of the fore wing once branched, not united with the cubitus and anal vein. Cauda with 7-15 hairs, the longer hairs 20-100  $\mu$  long ..... 14
- 14. Abdominal tergite VIII with 3-4 hairs ..... 15
- Abdominal tergite VIII with 4-12 hairs ..... 16
- 15. Abdominal segment VII with two stout hollow hairs, 59-88  $\mu$  long, and 3-5  $\mu$

- wide near the base. Antennae 0.46-0.51 times as long as the body. Length of the body 1.1-1.3 mm. Abdominal tergites I-VI without hairs. From leaves of *Litsea glutinosa*, with embryos either similar to those of apterae from *Litsea*, or of presumably *Distylium stellare* ..... *Schizoneuraphis gallarum*
- Abdominal segment VII with four long setae, and hairs on the dorsum of other segments. Antennal segment III with 22-24 annular rhinaria, IV with 10-12, V with 7-8. Length of the body 1.6-1.7 mm. (Ghosh & Raychaudhuri, 1973). From leaves of *Cinnamomum* ..... *Euthoracaphis heterotricha*
16. Siphunculi located on segment V, with one hair besides the marginal hairs close to the siphunculi. The last rostral segment 1.2 times as long as the second tarsal segment of the hind leg. Antennal segment III, 2.8 times as long as IV, 3.8 times as long as V. The cauda without a knob, with 15 hairs. Length of the posterior hairs of the subgenital plate 22  $\mu$ . Tibia of the fore leg 1.05 times as long as the width of the head across the eyes. From *Viscum articulatum* and *Dendrophthoë pentandra*. One specimen only, with embryos similar to first stage larvae of apterae .....  
..... *Mesothoracaphis rappardi*
- Characters varying ..... 17
17. Hairs present on all abdominal tergites, on VIII, 2-13 in number ..... 18
- Hairs lacking on all or some abdominal tergites, on VII sometimes one hair ..... 19
18. Tibia of the fore leg 505-630  $\mu$  long, 1.2-1.4 times as long as the head across the eyes. Second tarsal segment of the hind leg with two hairs. Length of the stylets 290-335  $\mu$  long. Diameter of the pore of the siphunculi 33-50  $\mu$ . Length of the last rostral segment 96-113  $\mu$ . Length of the antennae 620-920  $\mu$ . Length of hairs on tergite VIII, 60-108  $\mu$ , on tergite IV, 49-104  $\mu$ . From galled leaves or galls on leaves of *Distylium stellare* ..... *Schizoneuraphis*
- Tibia of the fore leg 335-358  $\mu$  long, 0.85-0.87 times as long as the head across the eyes. Second tarsal segment of the hind leg with three hairs. Length of the stylets 220-231  $\mu$ . Diameter of the pore of the siphunculi 23-33  $\mu$ . Length of the last rostral segment 65-73  $\mu$ . Length of hairs on tergite VIII, 30-43  $\mu$ , on tergite IV, 16-25  $\mu$ . From galls on leaves of *Distylium stellare*, migrating to *Ficus* spp. ....  
..... *Reticulaphis*
19. Antennal segment III with 22-23 annular rhinaria, IV with 9-12, V with 5-9. Diameter of the pore of the siphunculi 55-83  $\mu$  ..... *Nipponaphis*
- Antennal segment III with 15 annular rhinaria, IV with seven, V with four. Diameter of the pore of the siphunculi 45  $\mu$  ..... *Metanipponaphis*

### Keys to the species

#### Key based on apterae

1. Head fused with the pronotum only ..... 2
- Head fused with pro-, meso-, and metanotum or next to this also with abdominal tergite I, or tergites I-VII ..... 42
2. Two anterior cephalic horns present, provided with four or more small hairs increasing in size to the base of the horn ..... 3
- Cephalic horns absent, or in any case not bearing four or more small hairs ..... 27



3. Anal plate and cauda without constriction. Length of pronotum plus head without horns 0.45-0.57 times the width of the prothorax. Marginal wax glands only, linearly arranged ..... 4
- Anal plate and also the cauda with a constriction. Length of pronotum plus head without horns 0.6-0.8 times the width of the prothorax. Wax glands varying ..... 5
4. Head ventrally with 18-37 hairs. Length of the longest hair of the horn 0.04-0.07 times the distance between the outer margins of the eyes. Siphunculi with 4-6 hairs, cauda with 13-22. In life (pls. 25, 26) black or brown with a fringe of wax; larvae brown or green. On *Schizostachyum blumii*, *S. zollingeri* and other bamboos, on shoots or on the inner side of scales ..... *Ceratoglyphina bambusae*
- Head ventrally with 40-43 hairs. Length of the longest hairs of the horns 0.09-0.11 times as long as the distance between the outer margins of the eyes. Siphunculi with 6-11 hairs, cauda with 25-29. In life (pl. 27) pale brown, with a wax fringe. Larvae pale green with on the abdomen two darker longitudinal lines. On bamboo shoot at the border of sheath and leaf blade ..... *Ceratoglyphina bengalensis*
5. Siphunculi with a cone provided with hairs. No sclerites with hairs on the abdomen. Spinal wax glands at most present on the head and abdominal tergite VIII ..... 6
- Siphunculi with or without hairs. If siphunculi with hairs then sclerites with one or more hairs on the abdomen, or spinal wax glands on thorax and some on the abdominal segments ..... 17
6. Horns with broadly rounded tip ..... 7
- Tip of horns pointed ..... 9
7. Tergite VI with three or more hairs, but in three out of 71 specimens with two only; tergites II and III each with 9-15 hairs. Wax gland cells on all thoracic and abdominal segments, but in one out of 60 specimens lacking on the head. Wax glands on abdominal segment VIII and V-II touching each other over at least half of their diameter with a flat border (fig. 158). Length of the last antennal segment 2.2-2.7 times its width, at least in specimens where the distance between the outer margins of the eyes is less than 1.30 times the length of the fore tibia. In life (pl. 18) with a dark green uninterrupted patch from the metanotum up to abdominal tergite VI. On *Bambusa blumeana* and other bamboos ..... *Astegopteryx unimaculata*
- Tergite VI usually with two hairs, but in 17 out of 158 specimens with more than two; tergites II and III each with 4-11 hairs. Wax gland cells on all, some or none of the 12 segments of the body. Wax gland cells on abdominal segment VIII and V-II frequently more spherical (figs. 9, 10, 46). Length of last antennal segment 3.0 or more times its width in specimens with the distance between the outer margins of the eyes less than 1.30 times the length of the fore tibia. In life with or without green, but this green is always interrupted, at least absent in the middle of abdominal segment III and IV ..... 8
8. Wax gland cells rounded, touching each other not at all or only in the middle. Wax gland cells on all or some segments, and sometimes completely lacking. Diameter of wax gland cells usually 10-15  $\mu$ . Colour in life is decisive: In life (pl. 8) with two longitudinal lines which are connected to each other on the metanotum and abdominal tergite I and nearly so on abdominal tergite V. On bamboo ..... *Astegopteryx minuta*

- Wax gland cells touching each other usually over a longer distance in the middle, and in general 20-40  $\mu$  in diameter. At least present on 10 of the segments of the body. In life (pls. 1-5) with green or without, but never green on head and mesonotum. On bamboo ..... *Astegopteryx bambusae*  
 In life three colour varieties can be distinguished:
  - 1a. Dark green transverse bands on metathorax and abdominal segment I, II and V. Some green on abdominal segments IV and VI. Green around siphunculi or lacking (pl. 1) var. *striata*
  - 1b. As 1a, but pale green, and frequently only visible on abdominal segments I and V. Sometimes green completely absent (pls. 2, 3) ..... var. *lutescens*
  - 1c. Green only on metathorax and abdominal segment I (pl. 5) ..... var. *maculata*
- 9. Siphunculi usually with 2-3 hairs, rarely with up to seven. Antennae 0.65-0.85 times as long as the width of the head across the eyes. Last rostral segment 0.73-0.92 times the length of the second tarsal segment of the hind leg. Tergite V between the siphunculi 2-3 hairs. In life (pl. 6) larvae pale yellow, red around the siphunculi. In adult apterae this red spreads more or less over the whole abdomen. On lower side of bamboo leaves on the base only .....  
 ..... *Astegopteryx basalis*
- Siphunculi with three or more hairs. Antennae 0.7-1.6 times as long as the width of the head across the eyes. Last rostral segment 0.52-0.87 times the length of the second tarsal segment of the hind leg. On tergite V between the siphunculi 3-13 hairs ..... 10
- 10. First tarsal segment of the fore leg with four, of the midleg with 3-4 hairs. Horns 0.04-0.08 times as long as the width of the head across the eyes. Longest hairs dorsally on the head 50-80  $\mu$ . Wax glands in part transversely arranged, and with a spinal group on abdominal segment VIII; The wax glands become indistinct in specimens from colonies with alatae. In life (pl. 7) bright yellow with orange marbling, covered with wax, more densely at margins. Horns of first stage larvae about 100  $\mu$  long. On lower side of bamboo leaves ..... *Astegopteryx glandulosa*
- First tarsal segment of the fore leg with three or sometimes with two or four hairs, of the midleg with 2-3 hairs. Horns 0.11-0.30 times as long as the width of the head across the eyes. Longest hairs dorsally on the head 18-53  $\mu$ . Wax glands in one row along the margin or somewhat radially arranged ..... 11
- 11. On abdominal tergite V between the siphunculi 3-8 hairs, and at the same time shortest distance between the two marginal wax gland groups of tergite VIII, 50-160  $\mu$ , seldom less, or wax glands are lacking on the tergite. Cauda with 5-9 hairs. First tarsal segment of the fore leg with three or sometimes two hairs ..... 12
- On abdominal tergite V between the siphunculi 10-20 hairs, or if less hairs then shortest distance between the two wax glands groups of tergite VIII, 0-35  $\mu$ . Cauda with 6-13 hairs. First tarsal segment of the fore leg with 3-4 hairs ..... 13
- 12. Sides of the horns straight or even slightly concave, the horns are 0.17-0.30 times as long as the width of the head across the eyes. Marginal wax gland groups on 0-12 segments of the body, but in most collections only present on some of the last abdominal segments. In antennae with four segments the last segment 0.26-0.39 times as long as the width of the head across the eyes. Longest hair on tergite IV 50-70  $\mu$ , spinal hair on VIII, 64-97  $\mu$ , length of the empodial hair of the hind leg 28-36  $\mu$ . Colour in life (pls. 11, 12) yellowish with distinct dark green marks in two longitudinal rows on the thorax and anterior abdominal segments, and usually also on abdominal segments IV to VIII. On the lower side of bamboo leaves ..... *Astegopteryx pallida*

- Outward side of horns usually distinctly convex; the horns are 0.11-0.24 times as long as the width of the head across the eyes. Marginal wax gland groups on 3-12 segments of the body, but usually on 12. In antennae with four segments the last segment 0.21-0.31 times as long as the width of the head across the eyes. Longest hair on tergite IV, 36-57  $\mu$ , spinal hair on VIII, 53-78  $\mu$ , length of the empodial hair of the hind leg 7-32  $\mu$ . Colour in life (pl. 17) yellowish without marks, or with very pale green marks on two or three segments of thorax and anterior abdominal segments, and sometimes indistinct green marks between the siphunculi. On the lower side of bamboo leaves ..... *Astegopteryx singaporensis*
- 13. Abdominal tergite V between the siphunculi with 10-20 hairs, or if less, on tergite IV the same number of hairs. Shortest distance between the two wax gland groups of abdominal segment VIII, 25-100  $\mu$ , seldom in some specimens of a population this distance is less, up to only four  $\mu$ . Sometimes wax glands lacking on head, thorax and several abdominal segments. Diameter of the pore of the siphunculi 45-90  $\mu$ . Length of the empodial hairs of the hind leg 0-6  $\mu$ . In life (pls. 14, 15) yellowish brown with marginal wax gland columns. On *Cocos* and other palms ..... *Astegopteryx rhapsidis*
- Abdominal tergite V between the siphunculi with 3-8 hairs. Shortest distance between the two wax gland groups of abdominal segment VIII, 0-35  $\mu$ . Seldom some specimens with wax glands lacking on head, thorax and abdominal segments I-VI. Diameter of the pore of the siphunculi 30-65  $\mu$ . Length of empodial hairs of hind legs varying ..... 14
- 14. Wax gland cells especially on abdominal segments II to IV arranged radially in a quarter or half arc. Distance between the inner margins of the wax glands between both sides of abdominal segment III, 0.27-0.32 times the length of the body. Mesothorax, metathorax and the first five abdominal segments dorsally with a brown patch. In life (pl. 13) brown but due to wax powder somewhat violet. Marginally with columns of wax. On *Cocos* lower side of leaf *Astegopteryx rappardi*
- Wax gland cells along the margin on each segment arranged in one row. Distance between the inner margins of the wax glands between both sides of abdominal segment III, 0.37-0.46 times the length of the body ..... 15
- 15. Empodial hairs of the hind leg 22-31  $\mu$  long. Second tarsal segment of the hind leg dorsoapically with two hairs widened at the tips, distally 2.5-4  $\mu$  wide. Length of horns 50-95  $\mu$ . Medial area of head, thorax and abdominal segments I-IV with oval separate wax glands with irregular border, the glands without angular facets. Linear s-shaped wax glands ventromarginally sometimes present, but not very distinct. Stylets 195-227  $\mu$  long. Cauda with 3-7 hairs. In life (pl. 10) brown or dark violet, with marginal columns of wax. On leaves of *Cocos* and other palms ..... *Astegopteryx nipae*
- Empodial hairs rudimentary, at most 4-10  $\mu$  long. Second tarsus of the hind leg dorsoapically with one or two hairs widened at the tips. Length of horns 40-65  $\mu$ . Medial area of head, thorax and abdominal segments without oval, separate wax glands. Linear s-shaped wax glands ventromarginally usually very distinct. Other characters varying ..... 16
- 16. Stylets 285-322  $\mu$  long. Horns 37-47  $\mu$  long, 0.12-0.17 times as long as the width of the head across the eyes. Longest hair dorsally on abdominal segment IV, 55  $\mu$ . Abdominal tergite VI with four hairs. Cauda with 10-15 hairs, the longest 53  $\mu$ . In

- life brown with marginal columns of wax. On leaves of *Freycinetia* .....  
 ..... *Astegopteryx pandani*
- Stylets 218-260  $\mu$  long. Horns 42-65  $\mu$  long, 0.17-0.24 times as long as the width of the head across the eyes. Longest hair dorsally on abdominal segment IV, 29-41  $\mu$ . Abdominal tergite VI with 2-3 hairs. Cauda with 6-12 hairs, the longest 35-49  $\mu$ . In life (pl. 9) brown or dark violet with marginal columns of wax. On leaves of *Alpinia*, *Amomum*, *Hedychium*, *Hornstedtia* and *Nicolaia* ..... *Astegopteryx muiri*
17. Head and prothorax smooth or almost smooth, and as well as mesothorax and abdominal segments marginally without distinct separate wax glands. Siphunculi without or with a narrow cone, without hairs. Stylets 200-275  $\mu$  long. Abdominal segment VIII with a group of 5-40 wax glands. Membrane of wax glands with pores but in two species with facets ..... 18
- Prothorax, and more or less also mesothorax, metathorax and head spinally, as well as marginally the thorax and abdominal segments with separate wax glands, 10-20  $\mu$  wide with irregular border. These glands are sometimes more or less convex and e.g. on the prothorax united to two swellings. Cone of the siphunculi more or less brown, sometimes with hairs. Stylets 230-545  $\mu$  long. Abdominal segment VIII spinally with a group of 0-14 wax gland cells. Membrane of the wax glands with facets ..... 22
18. Abdominal segment VIII with a spinal wax gland group with 11-14 cells. The abdominal segments I-VI and the thoracic segments each with two spinal wax gland groups of 2-6 cells. Head with two wax gland groups of 8-13 cells. Membrane of the glands with facets. In life (Van der Goot unpublished) dull black with marginal and two spinal rows of wax. On bamboo, lower side of leaves .....  
 ..... *Ceratovacuna keduensis*
- Abdominal segment VIII with a spinal wax gland group with 5-40 cells. No spinal wax gland groups on abdominal segments I-VI, or on meso- and metathorax. Head with two wax gland groups with 0-4 cells. Membrane of the glands with spherical or irregular pores ..... 19
19. Antennae with five segments, 0.27-0.31 times as long as the body, and 1.2-1.3 times the width of the head across the eyes; segment III cylindrical, its length about six times the basal width. Last rostral segment 0.7-0.8 times the length of the second tarsal segment of the hind leg. Head dorsally with 15-17 hairs, prothorax with 8-10. Abdominal segments I-VII dorsally with 2-5 hairs, marginal ones not included. Marginal wax gland groups on thorax and abdomen present or on abdominal segment VII only a group of 3-7 cells. Spinal wax glands of 11-15 cells on tergite VIII. Membrane of wax glands with facets but at the border of the cells with convolutions. On bamboo ..... *Ceratovacuna floccifera*
- Antennae with four or five segments, 0.12-0.24 times as long as the body, and 0.5-1.0 times the width of the head across the eyes; segment III widened distally, its length in specimens with five segments 2-4 times the basal width. Last rostral segment 0.5-0.6 times the length of the second tarsal segment of the hind leg. Membrane of the wax glands with pores. Other characters varying ..... 20
20. Abdominal tergite I with 15-19 hairs in the only available sample from Vietnam. Abdominal segment VII marginally with 12-17 wax gland cells. Embryos and first stage larvae without siphunculi. Spinal wax gland group of abdominal segment VIII with 35-40 cells (Van der Goot, 1917), but in the Vietnam specimens with 23-28. In life (Van der Goot, 1917) black or greyish black, densely covered

- with short wax. On grasses ..... *Ceratovacuna graminum*
- Abdominal tergite I with 4-8 hairs. Abdominal segment VII marginally with 0-11 wax gland cells. Embryos and first stage larvae with siphunculi ..... 21
21. Abdominal segment V between the siphunculi with 2-6 hairs; tergite I with 4-5 hairs. The anal plate with 12-15 hairs. Length of the body 1.54-1.84 mm. Abdominal segment VIII with a spinal wax gland group with 5-20 cells. Besides marginal wax gland groups, dorsally wax glands occur with jigsaw or network structure. Length of the longest hair of antennal segment IV, 0.07-0.14 times the distance between the outer margins of the eyes. In life (pl. 29) yellow or brownish with wax marginally and dorsally. On *Setaria*, *Microstegium* and other grasses .....  
..... *Ceratovacuna panici*
- Abdominal segment V between the siphunculi with 6-10 hairs; tergite I with 5-7 hairs, the subanal plate with 19-23 hairs. Length of the body 1.87-2.45 mm. Abdominal segment VIII with a spinal group of wax glands with 16-27 cells. Next to groups of wax glands dorsally a very fine network structure or convolutions. Length of the longest hair of antennal segment IV, 0.05-0.09 times the distance between the outer margins of the eyes. In life (pl. 28) dull yellow densely covered with wax, marginally with long threads. On *Saccharum* .. *Ceratovacuna lanigera*
22. The dorsum pale brown, the same colour as marginal sclerotized plates and the cone of the siphunculi, at most some pleural areas and some parts along the segmental borders colourless ..... 23
- Marginal and dorsal plates on mesothorax, metathorax and abdominal segment I brown, contrasting with the colourless surroundings. Sometimes also small sclerites and the cone of siphunculi brown ..... 25
23. Length of stylets 355-405  $\mu$ . Antennae 0.14-0.20 times as long as the body, and 0.58-0.77 times as long as the width of the head across the eyes. The processus terminalis in antennae with four segments 18-29  $\mu$  long, in five-segmented 20-30  $\mu$ . In life (pl. 42) blackish with columns of wax. On branch and sprouts of *Schizostachyum* and other bamboos ..... *Pseudoregma pendleburyi*
- Length of stylets 415-530  $\mu$ . Antennae 0.19-0.23 times as long as the body, and 0.69-0.89 times as long as the width of the head across the eyes. The processus terminalis in antennae with four segments 30-39  $\mu$  long, in five-segmented antennae 35-43  $\mu$ . Living on Zingiberaceae, Costaceae and Hypoxidaceae ..... 24
24. Length of dorsal hairs on the head 69-78  $\mu$ , on abdominal segment IV, 60-76  $\mu$ , and on abdominal segment VIII, 80-92  $\mu$ . Marginal wax glands on abdominal segment II with 7-12 glands, the pronotum with 7-17 spinal wax glands in each group. On *Hedychium*, and according to Takahashi (1935, 1941) on *Nicolaia*, *Costus* and *Elettaria* ..... *Pseudoregma nicolaiae*
- Length of dorsal hairs on the head 28-45  $\mu$ , on abdominal segment IV, 25-41  $\mu$ , and on abdominal segment VIII, 37-59  $\mu$ . Marginal wax glands 0-6 on abdominal segment II, the pronotum with 0-5 spinal wax glands in each group. Colour see pl. 42, 43. On *Alpina*, *Catimbium*, *Costus* and *Nicolaia* ..... *Pseudoregma sundanica*
25. Antennal segment III, 0.7-1.0 times as long as IV in four-segmented antennae. In five-segmented antennae III, 1.7-1.8 times as long as IV, and IV, 0.42-0.44 times as long as V. Length of stylets 230-295  $\mu$ . Abdominal segment V between the siphunculi with 2-8 hairs. Length of the body 1.1-1.9 mm. Head dorsally between the antennae almost smooth. Horns broadly rounded at the tip. Colour see pl. 41. On grasses, *Cyrtococcum*, *Oplismenus*, and *Setaria* ..... *Pseudoregma panicola*

- In four-segmented antennae segment III, 1.1-1.8 times as long as IV. In five-segmented antennae III, 1.0-1.6 times as long as IV, and IV, 0.56-0.74 times as long as V. Length of stylets 314-545  $\mu$ . Abdominal segment V between the siphunculi with 10-30 hairs. Length of the body 1.5-2.8 mm. Head dorsally between the antennae rough. Horns conical with more or less narrow rounded tips. On bamboos ..... 26
- 26. Abdominal segments I-V dorsally with small sclerites with one or more hairs. Abdominal segment VIII spinally with 0-2 wax gland cells. Other segments of the body with or without marginal and spinal wax gland cells. In life (pls. 37, 38, 39) greenish brown dusted with granular wax and a thick cushion of wax on the abdomen posterior to the siphunculi. Marginal and spinal columns of wax can be present on thorax and abdomen. On young and old parts of developing shoots of bamboo ..... *Pseudoregma bambusicola*
- Abdominal segments dorsally without sclerites, but wax gland cells situated in sclerotized plates. Abdominal segment VIII spinally with 8-14 wax gland cells. Other segments marginally and spinally with 0-10 wax gland cells, always present spinally on abdominal segments I-V. In life (pl. 40) yellow to purple-brown, with marginal and spinal columns of wax. On leaves and shoots of bamboo ..... *Pseudoregma montana*
- 27. Head with two blunt frontal horns, each on top with a hair shorter and thicker than normal hairs, on an elevated socket; or the horns are absent but 2-30 of such hairs are present ..... 28
- Head without horns, and short, thick hairs are lacking ..... 35
- 28. Stylets 180-300  $\mu$  long. Head without horns with a hair on top. Marginal groups of wax glands lacking ..... 29
- Stylets 360-680  $\mu$  long. Other characters varying ..... 31
- 29. Stylets 260-300  $\mu$  long. Head ventrally with 4-7 hairs shorter and thicker than normal, the two in the middle are the largest, 17-23  $\mu$  long and 5-6  $\mu$  wide. Cauda with 11-21, subgenital plate with 17-21 hairs. Abdominal tergite VII with 4-5 hairs, VI with 4-7. First tarsal segment of fore- and midleg with four hairs. First and second instar larvae with two spines on the head. In life (pl. 19) orange-yellow with wax. Inside separate galls in the axil of leaves of *Styrax benzoin* ..... *Cerataphis fransseni*
- Stylets 180-200  $\mu$  long. Head ventrally with four or more than eight spines. Cauda with 8-16 hairs, subgenital plate with 3-5 anterior and 7-12 posterior hairs. Abdominal tergite VII with two hairs, VI with 2-3. First tarsal segment of fore- and midleg with 3-4 hairs. First and second instar larvae with four or 26-33 spines on the head ..... 30
- 30. Head with four spines. Antennae with five segments, segment III, 1.2-1.5 times the length of IV. First and second instar larvae with four spines on the head. Inside flower galls of *Styrax benzoin* ..... *Astegopteryx styracophila*
- Head with more than eight spines. Antennae with four or five segments. In specimens with five antennal segments, III, 2-4 times the length of IV. First and second instar larvae with 26-33 spines on the head. In life (pl. 16) pale yellow with wax. Inside flower galls of *Styrax benzoin* ..... *Astegopteryx setigera*
- 31. Wax glands with a circular or elliptical border, in a single row marginally on the thoracic and abdominal segments. On the cone of the siphunculi 5-20 hairs. Length

- of hairs on abdominal tergite IV, 55-102  $\mu$ . Forehead with two blunt horns, each with a hair on top. Living on leaves and twigs ..... 32
- A row of circular or elliptical wax glands on the body is lacking. On the cone of the siphunculi 2-4 hairs. Length of hairs on abdominal tergite IV, 25-40  $\mu$ . Forehead with horns or with 2-4 frontal hairs, each on an elevated process. Living in galled leaves ..... 33
32. Cauda knobbed. Cone of the siphunculi with 14-20 hairs. Integumentum, legs and antennae very pale brown. In life (pl. 46) orange brown with a narrow wax fringe, and wax powder on dorsum. On *Scurrula* ..... *Rappardiella loranthi*
- Cauda not knobbed, at most on one side slightly curved. Cone of siphunculi with 5-7 hairs. Integumentum, legs, antennae and dorsal hairs brown. In life velvety black or bluish black with a narrow wax fringe. On *Scurrula* ..... *Rappardiella scurrulae*
33. Last rostral segment 116-128  $\mu$  long, 1.3-1.4 times as long as the second tarsal segment of the hind leg, its distal end pointed. Antennal segment III with two hairs, or rarely with one. Second tarsal segment of the hind leg 0.31-0.34 times as long as the tibia of the hind leg. On *Scurrula* in galled leaves .... *Rappardiella plicator*
- Last rostral segment 72-86  $\mu$  long, 0.7-1.0 times as long as the second tarsal segment of the hind leg, the distal end blunt. Antennal segment III with 2-6 hairs. Second tarsal segment of the hind leg 0.25-0.30 times as long as the hind tibia . 34
34. Forehead with two blunt horns each with a dagger-hair on top. Last rostral segment 1.0 times as long as the second tarsal segment of the hind leg. Antennae 0.25-0.29 times as long as the body. Wax glands slightly elevated warts 5-7  $\mu$  wide, over the whole dorsum. Length of the body 40-50 times the diameter of the siphunculi. In life (pl. 45) pinkish beige, covered with a glassy wax layer. On *Dendrophthoë pentandra* in galled leaves ..... *Rappardiella cerina*
- Head without horns, but with 2-4 short dagger hairs. Last rostral segment 0.7 to 0.8 times as long as the second tarsal segment of the hind leg. Antennae 0.31-0.40 times as long as the body. Wax glands dorsally as bands or areas with S structure. Length of the body 30-32 times the diameter of the siphunculi. In life (pl. 47) brown covered with flocculent wax with a thick cushion of wax wool around the body, but not on the head. On *Macrosolen cochinchinensis* in galled leaves ..... *Rappardiella macrosoleni*
35. Thorax and abdomen not sclerotic. Meso- and metathorax free. Wax glands with a membrane with pores are lacking. Cauda knobbed or not ..... 36
- Head, thorax and abdomen sclerotic. Meso- and metathorax fused. Wax glands with a membrane with pores; the glands arranged in a marginal line or only present on the head and thorax in an oval group. Cauda knobbed ..... 41
36. Separate circular wax glands with a diameter of 2-3  $\mu$  in areas on head thorax and abdomen, or on the abdomen only and in that case frequently open at one side. Length of body 1.3-2.0 mm ..... 37
- Wax glands linear or indistinct or arranged in convolutions ..... 38
37. Antennae with four segments. Siphunculi present. Living on leaves. Two morphs existing: 1. Apterous viviparous females, length of the body 1.44 mm (Van der Goot, unpublished). In collections larvae only: in 3-stage larvae length of the body 1.05-1.23 mm; the last rostral segment 0.76-0.82 times as long as the second tarsal segment of the hind leg, stylets 436-460  $\mu$  long, length of hairs of the cauda

- 23-25  $\mu$ . Circular wax glands on head, thorax and abdomen. In life (pl. 30) bright green with wax. 2. Van der Goot (unpubl.) oviparous female, no specimens in collections, as apterous viviparous females, but length 1.98 mm, and no wax glands on head and thorax. On leaves of *Distylium stellare* ..... *Distylaphis foliorum*
- Antennae with three segments. Siphunculi lacking. Stylets 236  $\mu$  long, the last rostral segment 1.38 times as long as the second tarsal segment of the hind leg, length of hairs of the cauda 78  $\mu$  long. Circular or open wax glands on the abdomen only, marginally. In galls of *Distylium stellare* ..... *Distylaphis foliorum*
38. Length of hairs dorsally on the head 131-176  $\mu$  long. Cauda with 9-13 hairs. Wax glands on the abdomen close to the siphunculi linear. Length of hairs on the first tarsal segments of the hind leg 12-20  $\mu$  long, of the empodial hairs 4-8  $\mu$ . In galls on leaves of *Distylium stellare* ..... *Schizoneuraphis longisetosa*
- Length of hairs dorsally on the head 38-131  $\mu$  long. Cauda with 4-8 hairs. Other characters varying ..... 39
39. Second tarsal segments dorsoapically with stout hairs, 35-40  $\mu$  long and widened at the tips, 3-5  $\mu$  wide at the tip. Wax glands linear or indistinct. Siphunculi absent in the fundatrix, present in the next generations. In galls on leaves of *Distylium stellare* ..... *Reticulaphis distylii*
- Second tarsal segments dorsoapically with minute hairs, 15-33  $\mu$  long, and not widened at the tip. Wax glands arranged in convolutions ..... 40
40. Siphunculi present in the fundatrix and also in next generations. Meso- and metathorax dorsally with more than 10 hairs, the marginal not included, 50-75  $\mu$  long. First tarsal segments of fore- and midleg with three hairs, the median 12-18  $\mu$  long, the others 5-8  $\mu$ . In galled leaves of *Distylium stellare* ..... *Schizoneuraphis gallarum*
- Siphunculi lacking in the fundatrix. Meso- and metathorax dorsally bare (Van der Goot, unpublished), or at most with some hairs. In the scanty material available hairs of first tarsal segments are lacking. In galls on leaves of *Distylium stellare* ..... *Neohormaphis calva*
41. Abdominal segment I free. Only ventrally on head and thorax some groups of wax glands. Marginal and dorsal hairs 33-185  $\mu$  long, and 5-12  $\mu$  wide near the base. Last rostral segment 0.6-0.9 times as long as the second tarsal segment of the hind leg. In life (pls. 31, 32) greenish brown or yellowish green. On sheaths of sprouts of *Bambusaceae* ..... *Glyphinaphis bambusae*
- Abdominal segments I-VII fused. A row of wax glands marginally along head, thorax and abdomen. Marginal and dorsal hairs 10-15  $\mu$  long, and 1-2  $\mu$  wide at the base. Last rostral segment 2.0-2.4 times the length of the second tarsal segment of the hind leg. In life black with a marginal wax fringe. On flower stems and stalks of *Blumea* ..... *Aleurodaphis blumeae*
42. Head fused with the thorax but not with abdominal tergite I. Head with two horns without hairs, but the horns are sometimes rudimentary. Head with or without dagger hairs. A marginal row of wax glands frequently present ..... 43
- Head fused with thorax and abdominal tergite I, or I-VII. Head without horns or dagger hairs. A marginal row of wax glands is absent ..... 47
43. Stylets 520-700  $\mu$  long. Last rostral segment 0.9-1.1 times the length of the second tarsal segment of the hind leg. Cauda with 11-12 hairs. Head ventrally with two horns but without dagger hairs. Length of siphuncular hairs 12-25  $\mu$ , of marginal



- hairs 20-40  $\mu$ . In life black with a marginal wax fringe. On Orchidaceae .....  
*Cerataphis orchidearum*
- Stylets 260-450  $\mu$  long. Last rostral segment 0.6-0.9 times the length of the second tarsal segment of the hind leg. Other characters varying ..... 44
  - 44. Cauda with 5-10 hairs. Head ventrally with 2-6 dagger hairs; exceptionally dagger hairs nearly as normal hairs, but socket about twice as wide as that of normal hairs. Stylets 275-450  $\mu$  long. Abdominal segment VIII with 9-15 hairs ..... 45
  - Cauda with 11-15 hairs. Head ventrally without dagger hairs. Stylets 280-350  $\mu$  long. Abdominal segment VIII usually with 5-10 hairs ..... 46
  - 45. Metanotum with 10-15 hairs, mesonotum with 5-10, and tergite VIII with 11-16. Stylets 325-435  $\mu$  long. Abdominal segments V-VII each ventrally to the marginal wax glands with 4-10 hairs. Siphuncular hairs 33-45  $\mu$  long. Marginal hair of abdominal segment VII, 35-65  $\mu$  long. Head ventrally with 2-6 dagger hairs. In life (pl. 20) black with a marginal wax fringe. On leaves of *Freycinetia* and according to Dr F.W. Rappard on *Pothos hermaphroditus* ..... *Cerataphis freycinetiae*
  - Metanotum with 4-8 hairs, mesonotum with 4-7, and tergite VIII with 9-15. Stylets 270-410  $\mu$  long. Siphuncular hairs 0-30  $\mu$  long. Marginal hair of abdominal segment VII, 15-43  $\mu$  long. Head ventrally sometimes with more than two dagger hairs. In life (pl. 22) dull black with a marginal wax fringe. On leaves of Palmaeae ..... *Cerataphis palmae*
  - 46. Length of siphuncular hairs 2-7  $\mu$ . Dorsal and marginal hairs nearly always with blunt rounded tips, sometimes wider at the tip than at the base. Last rostral segment 0.71-0.85 times the length of the second tarsal segment of the hind leg. Antennae 0.49-0.61 times as long as the width of the head across the eyes, and the tibia of the fore leg 0.29-0.35 times this width. Longest marginal hair dorsal to the row of wax glands 6-15  $\mu$  long. In life (pl. 21) shiny brown with a marginal wax fringe. On leaves of *Cocos nucifera* ..... *Cerataphis lataniae*
  - Length of siphuncular hairs 12-20  $\mu$ . Dorsal and marginal hairs pointed. Last rostral segment 0.57-0.65 times the length of the second tarsal segment of the hind leg. Antennae 0.66-0.83 times as long as the width of the head across the eyes, and the tibia of the fore leg 0.36-0.44 times this width. Longest marginal hair dorsal to the row of wax glands 20-30  $\mu$  long. In life (pl. 23) brownish black, dull, with a marginal wax fringe. On leaves of *Pothos roxburghii* .....  
*Cerataphis pothophila*
  - 47. Siphunculi absent. The length of the prosoma 7.3-10.0 times as long as the complex II-VII; dorsum of the prosoma and of the complex of abdominal tergites II-VII reticulate. On the prosoma on each side seven marginal hairs, and posterior to the eyes four pairs of spinal hairs on pro-, meso-, metathorax and abdominal segment I. Marginal hairs on the abdominal segments II-VII-complex, but no spinal hairs. Pleural hairs are lacking. On *Ficus* spp. .... *Reticulaphis distylii*
  - Siphunculi present. The length of the prosoma 2.6-6.9 times as long as the complex II-VII; the dorsum not reticulate; at best the muscular plates show some reticulation. Other characters varying ..... 48
  - 48. The head, thoracic segments and abdominal segments II-VII constitute one prosoma and even the margins of II-VII are not separated ..... 49
  - The prosoma consists of head, thoracic segments and abdominal segment I, at least the margins of segments II-VII are free ..... 50

49. Posterior to the eyes on each side 13 marginal hairs, 33-43  $\mu$  long and four  $\mu$  wide near the base, but hairs of segment V and VI are shorter. Tergite VIII with four hairs, 42-49  $\mu$  long. Abdominal segments I and II dorsally each with two hairs. The dorsal side with oval pustules, but without hair-like processes. Antennae 98-137  $\mu$  long. On *Quercus* spec. .... *Neohormaphis calva*
- Posterior to the eyes on each side nine stout hairs, 92-127  $\mu$  long. Tergite VIII with four hairs, the middle 120  $\mu$  long. Abdominal segment I dorsally with 0-1 hair, segment II without hairs. The body densely covered with hair-like processes, 15-40  $\mu$  long, lacking on muscular plates and abdominal segments II-VII. Antennae 29-40  $\mu$  long. On *Lithocarpus indutus* ..... *Sinonipponaphis hispidula*
50. The meso- and metanotum in the middle with ridges arranged in two longitudinal lines, 150-220  $\mu$  apart, the area in between usually sunk 10-40  $\mu$ . Margin of the prosoma radially striped, the stripes 20-70  $\mu$  long. Marginal hairs 70-80  $\mu$  from the margin of the prosoma, 141-208  $\mu$  long. Knob of the cauda roundish, almost as long as it is wide. The abdominal complex II-VII with marginal, pleural and medial hairs. Antennae 80-110  $\mu$  long. Larvae with roundish wax glands with a diameter of 2-4  $\mu$ , arranged in marginal longitudinal bands and in dorsal oval areas. On *Quercus* spec. .... *Thoracaphis arboris*
- The meso- and metanotum in the middle not with ridges arranged in two longitudinal lines, and the margin of the prosoma not radially striped. Other characters varying ..... 51
51. Dorsal hairs 120-170  $\mu$  long, 7-10  $\mu$  thick near the base. Tergum smooth apart from some pustules along transversal furrows between intermuscular plates. The sides of the body dorsal to the legs with oval wax glands ..... 52
- Dorsal hairs 15-120  $\mu$  long, near the base not more than four  $\mu$  thick. Other characters varying ..... 53
52. Stout dorsal hairs with fine acute tips. Besides these hairs more than five times as many small ones, 40-60  $\mu$  long. On leaves of *Litsea amara* .....  
..... *Schizoneuraphis litseicola*
- Stout dorsal hairs with acuminate tips. Smaller hairs absent. In life (pl. 48) shiny brown or black with hairs. On leaves of *Litsea* and *Lansium* .....  
..... *Schizoneuraphis gallarum*
53. Prosoma brown with a trapeziform area which is separated by colourless sutures, anteriorly from the pronotum, posteriorly from the abdominal tergites complex II-VII, and laterally from the marginal areas. Hairs 80-125  $\mu$  long, on tubercles with a diameter of 12-14  $\mu$ , next to 5-10 times as many hairs, 25-70  $\mu$  long with a smaller base. Abdominal tergites complex II-VII with on each side six marginal hairs, and anterior to the siphunculi on each side about 10 hairs, and posteromedial on segment VII two hairs. Abdominal tergite VIII (Ghosh & Raychaudhuri, 1973) with four long hairs. On *Cinnamomum verum*, and *C. iners* .....  
..... *Euthoracaphis heterotracha*
- A trapeziform area on the prosoma is lacking. Other characters varying ..... 54
54. Abdominal tergite VIII with two hairs, 45-52  $\mu$  long. Stylets 440-495  $\mu$  long. The prosoma on the posterior side not separated from the abdominal segments complex II-VII by a furrow, only a distinct marginal furrow is present. Length of marginal hairs of the abdominal tergites complex II-VII, 12-25  $\mu$ . The prosoma with pustules, observable as half rings or ellipses, at a distance from each other

- of 6-12  $\mu$ ; near the margin of the plate a pattern of irregular lines like a jigsaw puzzle. On "wranak", *Lithocarpus sundaicus* ..... *Metanipponaphis vandergooti*
- Abdominal tergite VIII with 3-10 hairs, 35-159  $\mu$  long. Stylets 570-1080  $\mu$  long. Length of marginal hairs of the abdominal tergites complex II-VII, 17-135  $\mu$ . Margin of the prosoma without irregular lines like a jigsaw puzzle ..... 55
55. Prosoma almost smooth, finely punctate, but with three medial transverse folds with some pustules. Antennae 76-90  $\mu$  long, 0.07-0.09 times as long as the body. On each of the thoracic segments spinally 3-7 hairs, and on abdominal segment I spinally sometimes one hair. On the abdominal tergites complex II-VII spinal hairs are lacking, sometimes one hair is present anterior to the siphunculi. In life (pl. 33) a brownish black box. On Loranthaceae, *Dendrophthoe pentandra*, and *Viscum articulatum* ..... *Mesothoracaphis rappardi*
- Antennae 202-279  $\mu$  long, 0.13-0.22 times as long as the body. Other characters varying ..... 56
56. Abdominal tergite VIII with 8-10 hairs. Antennae with four segments; segment III with 2-5 hairs, 35-51  $\mu$  long. Prosoma smooth, finely punctated, only low pustules in a groove between the eyes and the posteriorly located muscular plate, and along the margins of some furrows. Abdominal tergite VII free from the complex of segments II-VI, with 6-13 marginal plus dorsal hairs, 45-90  $\mu$  long. In life (pl. 36) a brown box. On *Lithocarpus bennettii* ..... *Nipponaphis semiglabra*
- Antennae with three segments, segment III without hairs, but apical setae are present. The prosoma with pustules. Abdominal tergite VIII with 4-8 hairs. Abdominal tergite VII fused with the complex of segments II-VI, and with at most two hairs in the middle area ..... 57
57. The prosoma with only two spinal hairs on the pronotum, on meso- and metanotum each three, and two on abdominal tergite I. No spinal hairs on the abdominal segments complex II-VII. Length of the hairs 100-125  $\mu$ . Pustules on the prosoma 10-25  $\mu$  wide at the base, the intervals between the pustules 1-5  $\mu$ . In life (pl. 35) with swellings and grooves. On *Castanopsis acuminatissima* ..... *Nipponaphis javanica*
- The prosoma with at least four spinal hairs on the pronotum, seven on the mesonotum, five on the metanotum, and three on abdominal tergite I, 10-125  $\mu$  long. Other characters varying ..... 58
58. Length of hairs on the prosoma and along the margins of the body 10-20  $\mu$ . Length of hair on tergite VIII, 35-40  $\mu$ . Hairs along the posterior margin lacking, number of hairs on tergite VIII four. The distal rhinarium of antennal segment III, 10-14  $\mu$  from the tip. In life (pl. 34) brown with furrows and pits. On *Castanopsis argentea* ..... *Nipponaphis brevopilosa*
- Length of hairs on the prosoma and along the margins of the body 63-120  $\mu$  long. Length of hair on tergite VIII, 65-159  $\mu$ . Hairs along the posterior margin lacking, number of hairs on tergite VIII, 6-8 in *N. ficicola*, or on tergite VII two hairs along the posterior margin, and four hairs on tergite VIII in *N. multisetosa*. Other characters varying ..... 59
59. The distal rhinarium of antennal segment III, 12-16  $\mu$  from the tip. Abdominal tergite VIII with four hairs, 65-118  $\mu$  long. Tergite VII with two hairs along the posterior margin. The number of dorsal plus dorsally observable marginal hairs on the metathorax about 35, on abdominal segment I, 30. Dorsal to the two pairs

of spiracula coarse pustules with rounded or pointed tips. In life about as *N. brevipedosa*. On *Castanopsis javanica* ..... *Nipponaphis multisetosa*

- The distal rhinarium of antennal segment III, 0-4  $\mu$  from the tip. Abdominal tergite VIII with 6-8 hairs, 120-159  $\mu$  long. Hairs along the posterior margin of tergite VII lacking. The metathorax on each side with three hairs, the dorsum with 5-6; abdominal segment I on each side with 2-3 hairs, the dorsum with 3-5 hairs. Pustules dorsal to the spiracula similar to others on the sides of the body. On *Ficus benjamina* and *Ficus spec.* ..... *Nipponaphis ficicola*

#### Key based on alatae

1. Anterior cephalic horns present or if absent, 6-15 small hairs, 4-10  $\mu$  long on two areas dorsal and lateral to the median ocellus. In one species 32-40 of these hairs, 4-6  $\mu$  long, also present in the median area ..... 2
  - Anterior cephalic horns lacking. Anterior to the paired ocelli 8-10 normal larger hairs ..... 24
2. Subanal plate entire, ventrally in the middle only curved inwards; in the middle brown. Horns 40  $\mu$  long or longer; longest hair on the horns 25-50  $\mu$ . Subgenital plate with 30-55 hairs. Second tarsal segment of the hind leg dorsoapically with two hairs with widened tip. First tarsal segment of the fore leg with four hairs . 3
  - Subanal plate bilobed. Hairs on horns, if horns are present, at most 15  $\mu$  long. Subgenital plate with 9-38 hairs. Second tarsal segment of the hind leg dorsoapically with 0-2 hairs widened at the tips. First tarsal segment of the fore leg with 2-4 hairs ..... 4
3. Abdominal segment VIII dorsally with 5-6 hairs, segment V between the siphunculi with 7-9. Siphunculi with 3-6, cauda with 17-19 hairs. Subgenital plate with 30-36 hairs. Head ventrally with 35-40 hairs. Length of the longest hair of the siphunculi 0.08-0.09, of the horns 0.05-0.06 times as long as the width of the head across the eyes ..... *Ceratoglyphina bambusae*
  - Abdominal segment VIII dorsally with 7-12 hairs, segment V between the siphunculi with 10-11. Siphunculi with 7-11, cauda with 28-29 hairs. Subgenital plate with 39-55 hairs. Length of the longest hair of the siphunculi 0.10-0.13, of the horns 0.08-0.09 times as long as the width of the head across the eyes ..... *Ceratoglyphina bengalensis*
4. Thirty to forty small hairs dorsal to the median ocellus, also present in the median area. Antennal segment III with 18-25 rhinaria, 2.6-3.6 times as long as segment IV, and 1.2-1.5 times as IV plus V. Cauda not knobbed. First tarsal segment of fore- and midleg with three hairs. Siphunculi pale brown, with 3-7 hairs. Embryos with pointed horns, wax glands, and in life with two green patches on the abdomen ..... *Astegopteryx setigera*
  - Number of small hairs dorsal to the median ocellus less than 20. Other characters varying ..... 5
5. Siphunculi a ring without a cone, about five  $\mu$  high; or with a pale brown cone extending outside the pore about five  $\mu$  wide. Exceptionally some specimens of *Pseudoregma panicola* posterior to the siphunculi with a brown cone of 40  $\mu$ ; see other characters under 6 ..... 6

- Pale brown cone of the siphunculi extending outside the pore 20-50  $\mu$ . Other characters under 11 ..... 11
- 6. Length (fig. k) of the pterostigma from the base of the radial sector to the anterior margin of the wing (1) 0.5-0.8 times the distance from the end of the pterostigma to the end of the radial sector (2) ..... 7
- Length of the pterostigma from the base of the radial sector to the anterior margin of the wing 1.0-1.4 times the distance from the end of the pterostigma to the end of the radial sector ..... 10
- 7. Length of longest hairs dorsally on the head 10-14  $\mu$ , on abdominal segment IV, 18-24  $\mu$ . Last rostral segment 0.8 times the length of the second tarsal segment of the hind leg. Antennae 1.6-1.9 times as long as the width of the head across the eyes ..... *Ceratovacuna floccifera*
- Length of longest hairs dorsally on the head 18-35  $\mu$ , on abdominal segment IV 25-45  $\mu$ . Other characters varying ..... 8
- 8. Antennae with four or five segments. In antennae with five segments, segment IV, 0.65 times as long as V ..... *Ceratovacuna keduensis*
- Antennae with five segments. Antennal segment IV, 0.79-1.14 times as long as V . ..... 9
- 9. Antennal segment IV with 5-10 rhinaria, V with 2-9. Subgenital plate with 24-38 hairs, the cauda with 15-19. Pleural part of abdominal segment VII usually less brown than the spinal part; abdominal segment VI hardly with any brown colour. Last rostral segment 0.5-0.6 times as long as the second tarsal segment of the hind leg. Antennae 0.20-0.29 times as long as the body, and 0.9-1.3 times the width of the head across the eyes. In life black ..... *Ceratovacuna lanigera*
- Antennal segment IV with 7-15 rhinaria, V with 6-14. Subgenital plate with 18-26 hairs, the cauda with 12-20. Pleural part of abdominal segment VII as brown as the spinal part; abdominal segment VI, pleurally and spinally with some brown colour. Last rostral segment 0.6-0.8 times as long as the second tarsal segment of the hind leg. Antennae 0.26-0.41 times as long as the body, and 1.1-1.9 times the width of the head across the eyes. In life black with a yellowish brown abdomen. From *Setaria*, *Microstegium* and other grasses ..... *Ceratovacuna panici*
- 10. Cauda with 13-15 hairs, gonapophyses at each side with 5-8. Second tarsal segments of all legs with one dorsoapical hair 45-63  $\mu$  long, with expanded tip. Subgenital plate with 8-11 anterior, and 9-16 posterior hairs. From *Oplismenus*, *Cyrtococcum* and other grasses ..... *Pseudoregma panicola*
- Cauda with 19-22 hairs, gonapophyses on each side with 9-11. Second tarsal segments of all legs without dorsoapical hairs with expanded tips, these hairs with acute tips, 27-35  $\mu$  long. Subgenital plate with 10-19 anterior, and 13-17 posterior hairs. From bamboo ..... *Pseudoregma montana*
- 11. Abdominal segment V dorsally between the siphunculi with two hairs. Subgenital plate with 4-5 anterior hairs, and 12-20 posterior hairs. Siphunculi with 2-5 hairs. First tarsal segment of the midleg with 2-3 hairs. Tibia of the fore leg 0.8-1.0 times as long as the width of the head across the eyes. Cauda with 11-17 hairs. Length of the tip of antennal segment V distal to the last linear rhinarium 6-14  $\mu$  ..... *Astegopteryx basalis*
- Abdominal segment V dorsally between the siphunculi with 4-16 hairs; but if 2-5, then the first tarsal segment of the midleg with usually four hairs, the tibia of the

- fore leg 1.1-1.2 times as long as the width of the head across the eyes, and the length of the tip of antennal segment V distal to the last linear rhinarium 16-38  $\mu$  long ..... 12
12. First tarsal segment of the fore leg with four hairs, of the midleg with 3-4 ..... 13
- First tarsal segment of the fore leg with 2-3 hairs, but in *A. rhapsidis* sometimes with four; midleg with 2-3 hairs ..... 17
13. Antennal segment III with 11-25 linear rhinaria. Abdominal tergite VIII with four hairs ..... 14
- Antennal segment III with 16-43 linear rhinaria. Abdominal tergite VIII with 5-12 hairs ..... 15
14. Length of body 1.3-1.7 mm. Antennal segment III with 11-15 linear rhinaria, IV with 6-8, V with 4-7. Cauda with 9-12 hairs. Tibia of the hind leg 456-480  $\mu$  long. Antennal segment III, 1.6-2.0 times as long as V, and 0.8-1.0 times as IV plus V. Embryos with marginal wax glands on all of the abdominal segments arranged in a straight line, the partition walls of the glands in each group are almost parallel to each other. From flower galls of *Styrax benzoin*. *Astegopteryx styracophila*
- Length of body 1.9-2.1 mm. Antennal segment III with 21-25 linear rhinaria, IV with 8-15, V with 8-10. Cauda with 12-17 hairs. Tibia of the hind leg 700-716  $\mu$  long. Antennal segment III, 2.1-2.4 times as long as V. Embryos with marginal wax glands on some of the abdominal segments somewhat triangular or wedge-shaped, and so the partition walls of these glands in a group not parallel to each other. Collected from Sumatra, not from Java, from flower galls of *Styrax* spec. ....  
..... *Astegopteryx ? rappardi*
15. Stylets 400-518  $\mu$  long. Cauda with 17-30 hairs. Antennal segment III with 28-47 linear rhinaria. Horns 0.03-0.07 times as long as the width of the head across the eyes. Length of the tibia of the fore leg 1.2-1.7 times as long as the width of the head across the eyes ..... *Pseudoregma bambusicola*
- Stylets 237-425  $\mu$  long. Cauda with 10-22 hairs. Antennal segment III with 16-32 linear rhinaria. Horns at most 0.04 times as long as the width of the head across the eyes. Length of the tibia of the fore leg 0.9-1.2 times as long as the width of the head across the eyes ..... 16
16. Cone of the siphunculi colourless with 10-20 hairs. Subgenital plate with 4-7 anterior, and 9-17 posterior hairs. Length of hairs dorsally on the head 18-39  $\mu$ , on abdominal tergite IV, 22-29, and the longest hairs of the cauda 25-37  $\mu$ . Stylets 237-253  $\mu$  long. Abdominal tergite V with 4-7 hairs, VI with 2-3 .....  
..... *Astegopteryx glandulosa*
- Cone of the siphunculi with a pale brown sclerite extending posteriorly 25-55  $\mu$ . Subgenital plate with 7-9 anterior hairs, and 8-14 posterior hairs. Length of hairs dorsally on the head 12-16  $\mu$ , on abdominal tergite IV, 14-21  $\mu$ , and the longest hairs of the cauda 55-65  $\mu$ . Stylets 350-425  $\mu$  long. Abdominal tergite V with 7-13 hairs, VI with 3-5 ..... *Pseudoregma sundanica*
17. Second tarsal segment of the hind leg and frequently also of the midleg dorsoapically with two hairs widened at the tips, diameter 2.5-5  $\mu$ . Abdominal segment V between the siphunculi with 4-6 hairs. Abdominal segment VIII with 4-5 hairs 18
- Second tarsal segment of the hind leg dorsoapically with one hair widened at the tip, or the tip up to one  $\mu$  wide, hardly discernable. Other characters varying .. 19
18. Antennal segment V with 6-14 rhinaria. Cauda with 11-14 hairs, the longest 53-63

- $\mu$ . Abdominal tergite VI with 2-4 hairs. Embryos in the alatae with the marginal wax glands on the abdomen arranged more or less in a longitudinal row on each segment ..... *Astegopteryx nipae*
- Antennal segment V with 11-15 rhinaria. Cauda with 9-12 hairs, the longest 42-47  $\mu$ . Abdominal tergite VI with two hairs. Embryos in the alatae with the marginal wax glands, if present, on segments I-VI partly wedge-shaped, and the glands arranged in a curved line or irregularly ..... *Astegopteryx rappardi*
19. Abdominal segment V dorsally between the siphunculi with 10-16 hairs, and abdominal segment VIII with 3-5 hairs ..... *Astegopteryx rhapsidis*
- Abdominal segment V dorsally between the siphunculi with 4-7 hairs, and abdominal segment VIII with 5-10 hairs ..... 20
20. Horns absent or at most a low bump is present. Cauda with 11-13 hairs. Length of the longest siphuncular hair 0.06-0.07 times as long as the width of the head across the eyes. Subgenital plate with 11-14 hairs. Antennal segment V with 10-15 linear rhinaria. Length of the antennae 0.43-0.51 times as long as the body, and 0.9-1.2 times the width of the head across the eyes ..... *Astegopteryx muiri*
- Horns present. Other characters varying ..... 21
21. Head dorsally with 11-18 hairs, the 3-8 hairs posterior to the paired ocelli not included. Length of the antennae 1.8-2.4 times the width of the head across the eyes. Subgenital plate with 12-18 hairs, 4-8 of which, and usually five, in the anterior part ..... *Astegopteryx pallida*
- Head dorsally with 4-8 hairs, the 2-8 hairs posterior to the paired ocelli not included. Length of the antennae 1.3-2.1 times the width of the head across the eyes. Subgenital plate with 14-22 hairs four of which, rarely five, in the anterior part ..... 22
22. Distance from the last annular rhinarium of antennal segment V to the top of the segment 8-15  $\mu$ , 0.02-0.04 times the width of the head across the eyes. Tibia of the hind leg 1.14-1.18 times as long as the femur, and 1.06-1.14 times as long as the width of the head across the eyes. Horns 8-15  $\mu$  long, 0.02-0.04 times as long as the width of the head across the eyes, and 0.02-0.04 the length of the fore tibia. Siphunculi with 14-15 hairs ..... *Astegopteryx unimaculata*
- Distance from the last annular rhinarium of antennal segment V to the top of the segment 12-25  $\mu$ , 0.03-0.06 times the width of the head across the eyes. Tibia of the hind leg 1.27-1.40 times as long as the femur, and 1.27-1.60 times as long as the width of the head across the eyes. Horns 20-65  $\mu$  long, 0.05-0.16 times as long as the width of the head across the eyes, and 0.05-0.14 as the length of the fore tibia. Siphunculi with 7-13 hairs ..... 23
23. Alatae found from September to January. Abdominal tergite VIII with 6-11 hairs. Antennae 545-800  $\mu$  long, segment III with 20-39 rhinaria, IV with 8-17, V with 9-17. Subanal plate with 16-23 hairs, siphunculi with 7-13, but rarely with seven ..... *Astegopteryx bambusae*
- Alatae found from May to the middle of October. Abdominal tergite VIII with 5-7 hairs. Antennae 492-570  $\mu$  long, segment III with 24-26 rhinaria, IV with 8-9, and V with 8-9, but Van der Goot (1917) mentions 28, 13, 10 respectively. Subanal plate with 12-14 hairs, siphunculi with seven ..... *Astegopteryx minuta*
24. Antennae with four or indistinctly five segments. Body nearly bare only short setae on the body. Mesothorax cephalad with two small tubercles (Van der Goot,

- 1917). No specimens available ..... *Glyphinaphis bambusae*
- Antennae with five segments. Other characters varying ..... 25
  - 25. Length of the body 2.5-3.3 mm. Cauda more or less cone-shaped without or nearly without a constriction. Abdominal tergite V with 8-17 hairs. Antennal segment V with 7-10 rhinaria ..... 26
  - One or more of these four characters different ..... 27
  - 26. Length of hairs dorsally on the head 35  $\mu$ , on tergite IV, 186  $\mu$ , on tergite VIII, 140  $\mu$ . Antennal segment IV, 134  $\mu$  long. Last rostral segment 98  $\mu$  long, 0.83 times as long as the second tarsal segment of the hind leg. Length of the tibia of the fore leg 748  $\mu$ , of the second tarsal segment of the hind leg 118  $\mu$ . From leaves of *Quercus* ..... *Thoracaphis arboris*
  - Length of hairs dorsally on the head 18-25  $\mu$ , on tergite IV, 23  $\mu$ , on tergite VIII, 50-63  $\mu$ . Antennal segment IV, 155-190  $\mu$  long. Last rostral segment 78-81  $\mu$  long, 0.56-0.60 times as long as the second tarsal segment of the hind leg. Length of the fore tibia 890-1045  $\mu$ , of the second tarsal segment of the hind leg 129-141  $\mu$ . From *Distylium stellare* galls no. 3, with embryos exactly like first stage larvae of apterae living on leaves of *D. stellare* ..... *Distylaphis foliorum*
  - 27. First tarsal segment of fore- and midleg with three hairs. Siphunculi with 0-1 hair. Second tarsal segment of the hind leg apically with 2-4 hairs expanded at the tips. Dagger hairs are lacking on the head ..... 28
  - First tarsal segment of the fore leg with four, exceptionally with three hairs, of the midleg with three or four hairs. Siphunculi with 2-10 hairs. Second tarsal segment of the hind leg apically with 1-2 hairs expanded at the tips. On the head sometimes 2-6 hairs with a broader base than other hairs, and rather short, small dagger hairs ..... 39
  - 28. Last rostral segment 2.0-2.4 times the length of the second tarsal segment of the hind leg. Cauda with an almost spherical knob. Antennal segment IV with 4-6 linear rhinaria. First tarsal segments of the fore leg with 2-3 hairs, of the midleg with three, of the hind leg with 3-4. Siphunculi with 0-1 hairs. Width of the head across the eyes 17-25 times the length of the longest hair dorsally on the head. Second tarsal segment of the hind leg with two dorsoapical hairs with expanded tips. From leaves of *Blumea* ..... *Aleurodaphis blumeae*
  - Last rostral segment 0.5-1.3 times the length of the second tarsal segment of the hind leg. Other characters varying ..... 29
  - 29. Media unbranched, united with the cubitus and these again with the anal vein. Alatae from *Distylium stellare*. Antennal segment III, 1.8-2.0 times as long as segment V, second tarsal segment of the hind leg with three hairs; cauda without a distinct knob, with 4-6 hairs, subanal plate with 10 hairs; embryos in the alatae with button organs and thick hairs. Alatae from *Quercus*: Antennal segment III, 2.3-3.0 times as long as segment V, first tarsal segment of the hind leg with three hairs, cauda a distinct knob, 43-49  $\mu$  wide, with 7-8 hairs, subanal plate with 15-16 hairs; embryos in the alatae with thin hairs and without button organs ..... *Neohormaphis calva*
  - Media once branched, not united with the cubitus and anal vein ..... 30
  - 30. Length of hairs dorsally on the head 15-18  $\mu$ , 0.03-0.04 times the width of the head across the eyes. Cauda knobbed, with 9-12 hairs, up to 50  $\mu$  long. Last rostral segment 0.8-0.9 times the length of the second tarsal segment of the hind leg.



- Tibia of the fore leg 0.79-1.01 times as long as the width of the head across the eyes. Abdominal tergite VIII with 7-9 hairs, III-VII with 0-5 hairs. Length of the last rostral segment 98-108  $\mu$ . Diameter of the pore of the siphunculi 55-83  $\mu$ . From branches of *Castanopsis argentea* ..... *Nipponaphis brevopilosa*
- Length of hairs dorsally on the head 27-167  $\mu$ , 0.05-0.40 times the width of the head across the eyes. In *Reticulaphis distylii* hairs on the head sometimes 18-23  $\mu$  long, the last rostral segment 65-73  $\mu$  long, and the diameter of the pore of the siphunculi 23-33  $\mu$ . Other characters varying ..... 31
31. Antennal segment III, 2.6-4.2 times as long as IV, 4.3-5.6 times as long as V, and 1.6-2.2 times as long as IV plus V. Length of hairs dorsally on the head 84-167  $\mu$ , on tergite IV, 74-88  $\mu$ , on tergite VIII, 90-102  $\mu$ . Tibia of the fore leg 267-271  $\mu$  long, 0.68-0.73 times as long as the width of the head across the eyes. Length of hairs on the cauda 65-69  $\mu$ . Larvae of alatae with button organs, embryos inside the alatae sometimes also with button organs. From leaves of *Ficus* spp. ....  
..... *Reticulaphis distylii*
- Antennal segment III, 1.6-2.8 times as long as IV, 1.8-3.8 as V, and 0.9-1.6 as IV + V. Other characters varying ..... 32
32. Hairs present on all abdominal tergites, on tergite VII, 2-4 hairs, 2-4 times as long as the basal diameter of antennal segment III ..... 33
- Hairs present on abdominal tergite VIII, but not on tergites IV-VI and sometimes also lacking on VII ..... 36
33. Abdominal tergite VIII with four hairs. Antennal segment III, 2.0 times as long as IV, and 2.5-2.7 as long as V. Anal vein of the fore wing bordered with brown (data Ghosh & Raychaudhuri, 1973, and Van der Goot, unpublished). From leaves of *Cinnamomum* ..... *Euthoracaphis heterotracha*
- Abdominal tergite VIII with 8-13 hairs. Other characters varying ..... 34
34. Length of the body 2.42-2.82 mm. Antennal segment III, 397-433  $\mu$  long. Cauda with 10-12 hairs, 72-80  $\mu$  long. Length of hairs on tergite IV, 57-104  $\mu$  long, on VIII, 88-108  $\mu$ . Second tarsal segment of the hind leg 147-157  $\mu$  long, the dorsoapical hairs 67-74  $\mu$ . Embryos inside the body of the alatae with hairs 110-220  $\mu$  long, and with groups of pustules. From galls of *Distylium stellare* .....  
..... *Schizoneuraphis longisetosa*
- Length of the body 1.61-1.87 mm. Antennal segment III, 260-291  $\mu$  long. Cauda with 7-10 hairs, 27-62  $\mu$  long. Length of hairs on tergite IV, 16-55  $\mu$  long, on VIII, 30-72  $\mu$ . Second tarsal segment of the hind leg 83-128  $\mu$  long, the dorsoapical hairs 51-61  $\mu$ . Embryos inside the body of alatae with or without groups of pustules ..... 35
35. Antennal segment III, 1.9-2.6 times as long as IV, and 2.4-2.7 times as long as V. Length of the last rostral segment 65-73  $\mu$ . Length of hairs on tergite IV, 16-25  $\mu$ , on tergite VIII, 30-43  $\mu$ , on the subanal plate 27-37  $\mu$ . The second tarsal segment of the hind leg with three hairs, and with a protruding middle part. Embryos inside the alatae with hairs on the body 10-30  $\mu$  long. From fingertip-like galls on the upper side of leaves of *Distylium stellare*, migrating to *Ficus* .....  
..... *Reticulaphis distylii*
- Antennal segment III, 1.6-1.9 times as long as IV, and 1.8-2.3 times as long as V. Length of the last rostral segment 102-113  $\mu$ . Length of hairs on tergite IV, 49-55  $\mu$ , on tergite VIII, 60-72  $\mu$ , on the anal plate 69-72  $\mu$ . The second tarsal segment of

- the hind leg with two hairs, and without a protruding middle part. Embryos inside the alatae with hairs on the body 72-118  $\mu$  long. From oval galls, 25-50 mm long and 1.2-2.5 times as long as they are wide. On *Distylium stellare*, assumed to migrate to *Litsea glutinosa* ..... *Schizoneuraphis gallarum*
36. Abdominal segment VII with two stout hollow spinal hairs 50-90  $\mu$  long. Abdominal segment VIII dorsally with 3-4 hairs. Base of the subcosta with a group of 2-3 sensoria. From leaves of *Litsea* ..... *Schizoneuraphis gallarum*
- Abdominal segment VII without hairs or with small hairs. Abdominal segment VIII dorsally with 4-9 hairs. Base of the subcosta with a group of 5-9 sensoria .. 37
37. Siphunculi on segment V, with one hair, besides marginal hairs close to the siphunculi. Last rostral segment 1.2 times as long as the second tarsal segment of the hind leg. Length of the fore tibia 0.7, and length of hairs dorsally on the head 0.11-0.19 times as long as the width of the head across the eyes. Cauda not knobbed. From *Viscum articulatum* and *Dendrophthoë pentandra*. One specimen available only, with embryos exactly like first instar larvae of apterae .....  
.....*Mesothoracaphis rappardi*
- Siphunculi on segment VI, without hairs if marginal hairs are not included. Last rostral segment 0.7-0.8 times the length of the second tarsal segment of the hind leg. Length of the fore tibia 1.0-1.1, and length of hairs dorsally on the head 0.07-0.11 times the width of the head across the eyes. Cauda knobbed ..... 38
38. Antennal segment V with 7-9 linear rhinaria. Last rostral segment 0.7-0.8 times as long as the second tarsal segment of the hind leg. Abdominal segment VIII dorsally with 4-6 hairs. Marginal and spinal sclerites with tubercles present, especially well-developed marginally on abdominal segments III-VII. With embryos exactly like those of apterae. From branchlets and midribs of leaves of *Castanopsis acuminatissima* ..... *Nipponaphis javanica*
- Antennal segment V with three linear rhinaria plus a distal primary rhinarium. Last rostral segment 0.70 times as long as the second tarsal segment of the hind leg. Abdominal segment VIII dorsally with seven hairs. One specimen available, with embryos without groups of wax glands. From branchlets of *Lithocarpus sundaicus* ..... *Metanipponaphis vandergooti*
39. Subgenital plate with 7-11 hairs. Siphunculi located on abdominal segment IV, with 6-10 hairs. Length of hairs dorsally on the head 30-45  $\mu$  long, 0.06-0.09 times as long as the width of the head across the eyes. Stylets 460-510  $\mu$  long. Cauda rounded or knobbed. Head ventrally with 1-2 small dagger hairs. With embryos like those of apterae on *Scurrula*. From *Scurrula* ..... *Rappardiella scurrulae*
- Subgenital plate with 15-29 hairs. Siphunculi located on abdominal segment V, with 2-7 hairs. Other characters varying ..... 40
40. Cauda rounded ..... 41
- Cauda knobbed ..... 44
41. The last rostral segment 1.0-1.2 times as long as the second tarsal segment of the hind leg. Abdominal tergite VIII with 3-4 hairs. First tarsal segment of the midleg with four hairs, the subgenital plate with 2-3 anterior, and 12-14 posterior hairs. The antennae 1.4-1.7, the fore tibia 0.8-0.9 as long as the width of the head across the eyes. Embryos like those of apterae on *Scurrula*, but in one specimen embryos with short hairs of 7-10  $\mu$ , and the last rostral segment less than 0.4 times its length in the other embryos. From galled leaves of *Scurrula* .....  
..... *Rappardiella plicator*

- The last rostral segment 0.6-0.8 times as long as the second tarsal segment of the hind leg. Abdominal tergite VIII with 5-10 hairs. Other characters varying ..... 42
- 42. Antennal segment IV with 3-6 annular rhinaria, V with 1-4. Cauda with 15-23 hairs. First tarsal segment of the midleg with four hairs. Second tarsal segment of the hind leg 84-92  $\mu$  long. On the head 4-6 small dagger hairs, 12-18  $\mu$  long, and close to the base wider than normal hairs. First stage larvae are exactly like those of *Cerataphis palmae* apterae on *Cocos nucifera*. Native of stem-gall of *Styrax benzoin* ..... *Cerataphis fransseni*
- Antennal segment IV with 9-15, V with 7-13 annular rhinaria. Cauda with 9-13 hairs. First tarsal segment of the midleg with three or four hairs. Second tarsal segment of the hind leg 73-76  $\mu$  long, or 103-117  $\mu$ . On the head two small dagger hairs, close to the base wider than normal hairs ..... 43
- 43. Antennal segment IV, 1.1-1.5 times as long as segment V; segments III, IV and V with 24-29, 9-12, and 7-11 rhinaria respectively. Length of hairs dorsally on the head 35-42  $\mu$ , on the cauda longest hairs 53-61  $\mu$ . Length of the last rostral segment 52-55  $\mu$ , and of the second tarsal segment of the hind leg 73-76  $\mu$ . Embryos similar to first stage larvae of apterae on *Freycinetia*. From leaves of *Freycinetia* ..... *Cerataphis freycinetiae*
- Antennal segment IV, 0.8-1.0 times as long as segment V; segment III, IV and V with 30-44, 10-15, and 9-13 rhinaria respectively. Length of hairs dorsally on the head 14-16  $\mu$ , on the cauda longest hairs 26-39  $\mu$ . Length of the last rostral segment 73-81  $\mu$ , of the second tarsal segment of the hind leg 103-117  $\mu$ . Embryo exactly like first stage larvae. From galled leaves of *Macrosolen cochinchinensis* ..... *Rappardiella macrosoleni*
- 44. Head with 2-6 small dagger hairs ..... 45
- Head without small dagger hairs ..... 46
- 45. First tarsal segment of the midleg with four hairs. Antennal segment IV, 0.8-1.0 times as long as segment V; segment III, 2.4 times as long as segment V, with hairs 12-19  $\mu$  long. Cauda with 10-12 hairs, the longest 40  $\mu$ . Abdominal tergite VIII with 7-9 hairs. The subgenital plate with two anterior hairs. Stylets 520-540  $\mu$  long. From *Scurrula* ..... *Rappardiella loranthi*
- First tarsal segment of the midleg with three hairs. Antennal segment IV, 1.1-1.3 times as long as segment V; segment III, 2.9-3.8 times as long as segment V, without hairs. Cauda with 4-9 hairs, the longest 47-60  $\mu$ . Abdominal tergite VIII with 4-6 hairs. The subgenital plate with 4-12 anterior hairs. Stylets 288-378  $\mu$  long. Embryos exactly like first stage larvae on *Cocos*, or without horns and marginal wax gland groups. From *Cocos nucifera* and other palms ..... *Cerataphis palmae*
- 46. Last rostral segment 0.66-0.75 times as long as the second tarsal segment of the hind leg. Antennae 1.7-2.3 times as long as the width of the head across the eyes. Antennal segment IV with 15-20 annular rhinaria, V with 15-24. Cauda with 11-14 hairs. Subgenital plate with 3-5 anterior, and 12-16 posterior hairs. Embryos exactly like those of first stage larvae of apterae on *Pothos*. From *Pothos roxburghii* ..... *Cerataphis pothophila*
- Last rostral segment 0.75-0.99 times as long as the second tarsal segment of the hind leg. Antennae 1.2-1.8 times as long as the width of the head across the eyes. Antennal segment IV with 7-13 annular rhinaria, V with 2-14. Cauda with 15-19 hairs. Subgenital plate with 3-7 anterior, and 17-23 posterior hairs ..... 47

47. Antennal segment V with 2-8 annular rhinaria. Tibia of the fore leg 0.67-0.73 times as long as the width of the head across the eyes. Last rostral segment 61-68  $\mu$  long, 0.75-0.89 times as long as the second tarsal segment of the hind leg. Stylets 312-315  $\mu$  long. Length of hairs on tergite IV, 12-16  $\mu$ , on the cauda 50-55  $\mu$ . From *Cocos nucifera* ..... *Cerataphis lataniae*
- Antennal segment V with 10-14 annular rhinaria. Tibia of the fore leg 0.83-0.95 times as long as the width of the head across the eyes. Last rostral segment 83-101  $\mu$  long, 0.94-0.99 times as long as the second tarsal segment of the hind leg. Stylets 375-385  $\mu$  long. Length of hairs on tergite IV, 25-27  $\mu$ , on the cauda 63-78  $\mu$ . From Orchidaceae ..... *Cerataphis orchidearum*

### Descriptions

#### Genus *Aleurodaphis* Van der Goot, 1917 (figs. 1-8)

*Aleurodaphis* Van der Goot, 1917: 239 (type species *Aleurodaphis blumeae* Van der Goot, 1917)

Description (one species).— Apterous viviparous female. Body 0.9-1.4 mm long, 1.9-2.1 times as long as it is wide, the dorsum pale brown, sclerotic, divided by three transversal furrows into four parts: the head plus pronotum, the mesonotum plus metanotum, abdominal segments I-VII, and abdominal segment VIII. The margin of the body all around from head to abdominal segment VIII crenulated, with wax glands; dorsal to the wax glands, anterior to the eyes six hairs, the thoracic segments on each side two hairs, each of the abdominal segments on each side one hair, and segment VIII with 4-6 hairs; on each of the thoracic and abdominal segments I-VII, 2-3 dorsal hairs, the hairs 6-18  $\mu$  long. The dorsum with flat, oval structures, which are lacking at a zone of 20-30  $\mu$  medial to the marginal wax glands. The head without horns. Antennae 185-393  $\mu$  long, usually with five segments. Ultimate rostral segment 143-194  $\mu$  long, 2.1-2.8 times the length of the second tarsal segment of the hind leg, 6-7 times as long as it is wide, with primary hairs, and two accessory hairs; stylets 705-766  $\mu$  long. Siphunculi situated on abdominal segment VI. Cauda knobbed, subanal plate bilobed. Abdominal spiracula on each of abdominal segments II-VII.

Alate viviparous female.— Body length 1.3-1.5 mm.

Antennae with five segments, 507-620  $\mu$  long, 0.36-0.47 times as long as the body; segment III with 11-17 annular rhinaria, IV with 4-6, V with 1-7. The last rostral segment 197-209  $\mu$  long, 2.0-2.4 times as long as the second tarsal segment of the hind leg, 6-7 times as long as it is wide, with primary hairs and two accessory hairs; stylets 525-590  $\mu$  long. The medial vein of the fore wing once branched. Abdominal segments I-IV colourless, V with a small marginal sclerite, VI a pale brown marginal sclerite, joined with the pale brown sclerite of the siphunculi, which extends 20-30  $\mu$  outside the pore.

Etymology.— *Aleurodaphis*, *Aphis* with flour, name given by Van der Goot (1917).

***Aleurodaphis blumeae* Van der Goot, 1917**  
(figs. 1-8)

*Aleurodaphis blumeae* Van der Goot, 1917: 240.

Types.— Neotype apterous viviparous female (here designated) from presumably *Blumea* spec., Garoet (750 m), 13.viii.1916, leg. P. v.d. Goot, det. P. v.d. Goot. Additionally two alatae viviparous females from same sample. Neotype in the collection at the British Museum (Natural History), London. In his manuscript (unpublished, a copy supplied by the late Dr Hille Ris Lambers) Van der Goot adds some data on the apterae of this species and describes the alate viviparous female.

Apterous viviparous female.— In life: Body black, eyes black, antennae light brown, siphunculi and cauda black; the margin of the body all round with a flat horizontal fringe of wax (Van der Goot, 1917).

Macerated specimens.— (fig. 1; described from four specimens, three of which from Japan, leg. R. Takahashi): Body oval, 0.93-1.42 mm long, 1.9-2.1 times as long as it is wide, the dorsum pale brown, sclerotic, with oval structures, the margin with crenulated wax glands, interrupted by three transversal furrows: posterior to the pronotum, to the metanotum, and to tergite VII. The length of the head plus pronotum 0.97-1.12 times as long as the length of the mesonotum-metanotum complex, 0.61-0.76 as the abdominal I-VII complex, and 3.7-4.5 times as the length of abdominal segment VIII.

Head.— Head fused with the pronotum, dorsally with circular or oval structures, 8-20  $\mu$  wide, flat or up to eight  $\mu$  high, the margin 1-2  $\mu$  wide. Anterior to the eyes a row of 17 wax glands, which is lacking in some specimens with some intermediate alate characters. Dorsally to the wax glands anteriorly four hairs up to 16  $\mu$  long, and between the eyes 4-5 hairs, about 12  $\mu$  long; ventrally to the wax glands on the frons five hairs up to 40  $\mu$  long. Antennae pale brown, 185-393  $\mu$  long, 0.20-0.29 times as long as the body, 0.74-1.07 times the distance between the outer margins of the eyes, usually with five segments; segments I and II smooth, segment III with spinulose imbrications, in antennae with five segments 76-118  $\mu$  long, without hairs 1.3-1.7 times as long as IV, and 1.0-1.4 times as long as V; segment IV with spinulose imbrications, 59-69  $\mu$  long, 0.6-0.7 times as long as V, with a hair 15  $\mu$  long; segment V with spinulose imbrications, 100-116  $\mu$  long, the processus terminalis 29-33  $\mu$  long, with five apical setae, 10-15  $\mu$  long. Ultimate rostral segment (fig. 2) 143-194  $\mu$  long, 2.1-2.8 times the length of the second tarsal segment of the hind leg with almost parallel sides, 6-7 times as long as it is wide, the primary hairs at a distance of 30  $\mu$  from the distal end, 10  $\mu$  long, with two accessory hairs, 25  $\mu$  long, at 90  $\mu$  from the distal end; stylets 705-766  $\mu$  long. Eyes situated dorsally, between the marginal wax glands, brown, with three ommatidia, distance between the outer margins of the eyes 250-373  $\mu$ .

Thorax.— The prothorax with the same oval structures as on the head, at a distance of 10-18  $\mu$  from each other, and lacking over a distance of 40-50  $\mu$  from the marginal wax glands, and 10  $\mu$  from the posterior margin; muscular plates hardly discernable. Posterior to the eyes at each side 7-11 marginal wax glands with a wall about two  $\mu$  wide and without any observable structure, dorsally to the glands at each side two hairs, and in the middle area 2-4 hairs, 10-14  $\mu$  long. Meso- and

metathorax fused, marginally with a row of 10-14 wax glands on each side, the mesonotum with on each side two marginal and 4-9 dorsal hairs, the metanotum with two marginal and 4-6 dorsal hairs, 14  $\mu$  long. In the middle area between meso- and metanotum two intermuscular plates observable only by the lack of some oval structures. Legs pale brown, smooth, also the tarsi. Tibia of the fore leg 106-251  $\mu$  long, 0.42-0.69 times as long as the distance between the outer margins of the eyes. All first tarsal segments with 2-3 hairs, of the hind leg 35-50  $\mu$  long; the second tarsal segments of the hind leg dorsoapically with two hairs, 35-45  $\mu$  long, with expanded tip, three  $\mu$  wide; empodial hairs 25-33  $\mu$  long. Length of segments of the hind leg: femur plus trochanter 153-299  $\mu$ , tibia 149-318  $\mu$ , 0.94-1.03 times as long as the femur, and 0.61-0.82 times the distance between the outer margins of the eyes; first tarsal segment 23-35  $\mu$ , second tarsal segment 55-90  $\mu$ .

Abdomen.— Segments I-VII fused (but in some specimens with intermediate alate characters only with segmental borders), with oval structures (fig. 3) as on head and thorax, lacking at the margins with the wax glands the length of 40-60  $\mu$ ; without distinct intermuscular plates, each side with a continuous row of 15-26 wax glands, making a crenulate line, the outer wall of the glands about 2  $\mu$  thick, diameter of the glands 15-28  $\mu$ ; dorsally to the glands at each side on each segment one marginal hair, and dorsally on segment I, 3-4 hairs, on II, 2-3; III, 2-3, and segments IV-VII each with two hairs, 6-12  $\mu$  long; length of hairs ventrally on segment IV, 12-18  $\mu$ . Siphunculi situated dorsally on segment VI, about 60  $\mu$  away from the outer margin of the wax glands, the pore brown, 22-35  $\mu$  diameter, without hairs. Abdominal segment VIII dorsally free, transversely elongate, e.g. 75  $\mu$  long, 215  $\mu$  wide, without oval structures, the posterior margin with 11-14 wax glands, without any interval, with 4-6 hairs, 14-18  $\mu$  long. Cauda brown, distinctly knobbed, e.g. at the base 67  $\mu$  wide, diameter of the constriction 43  $\mu$ , the knob 27  $\mu$  long, and 40  $\mu$  wide, connected to the base by a stem, 12  $\mu$  long; the knob 43-63  $\mu$  wide, with eight hairs, the longest 35-41  $\mu$ . Subanal plate brown, bilobed, with 9-12 hairs, 51-57  $\mu$  long. Subgenital plate with 2-4 anterior hairs, 8-16  $\mu$  long, and 6-10 posterior hairs, 10-20  $\mu$  long. Gonapophyses two, each with 2-4 hairs, 6-20  $\mu$  long. Spiracula ventrally on each of abdominal segments II-VII.

Alate viviparous female.— In life: Head and thorax black, abdomen dull dark red. Eyes, antennae and legs black. Siphunculi and cauda dark red. Pterostigma of fore wings greyish black (Van der Goot, unpublished).

Macerated specimens.— (fig. 4) described from seven specimens, three of which from Japan and Korea): Body length 1.33-1.52 mm, 2.0-2.3 times as long as it is wide.

Head.— (fig. 4). Head brown or black with blunt spinulae of about one  $\mu$ , width across the eyes 360-395  $\mu$ , the frons dorsally to the median ocellus with 5-7 hairs, up to 22  $\mu$  long; anterior and posterior to the paired ocelli a transverse row, each of four hairs, 12-16  $\mu$  long. Antennae five-segmented, 507-620  $\mu$  long, 0.36-0.47 times as long as the body, and 1.3-1.7 times the width of the head across the eyes; segment I brown, somewhat wrinkled, segment II brown, ventrally mainly with spinulose imbrications, the spinulae 1-2  $\mu$  long; segments III-V (fig. 5) with ring-shaped secondary rhinaria, the rings are not closed on the dorsal side over half to the whole width of the antenna; between the rhinaria are 3-7 or more concentric ring-shaped spinulose imbrications, mainly on the dorsal side with interconnections. The rhinaria are 2-3  $\mu$  wide, the spaces eight  $\mu$  or more. The primary rhinaria are moulded with the ring-

shaped rhinaria to a complex structure; segment III with 11-17 annular rhinaria, IV with 4-6, V with 1-7; hairs on segment III, 8-14  $\mu$  long. Length of segment III, 170-287  $\mu$ , 1.7-3.0 times as long as IV, 1.4-2.2 times as long as V; segment IV, 91-110  $\mu$  long, 0.7-0.8 times as long as V; V, 125-155  $\mu$  long, the processus terminalis 23-35  $\mu$ . The last rostral segment (fig. 6) 197-209  $\mu$  long, 2.0-2.4 times the length of the second tarsal segment of the hind leg, with almost parallel sides, 6-7 times as long as it is wide, the primary hairs at a distance of about 35  $\mu$  from the distal end, 10  $\mu$  long, with two accessory hairs, about 35  $\mu$  long, at about 100  $\mu$  from the distal end; stylets 525-590  $\mu$  long. Eyes compound, the ocular tubercle extending sideways 30  $\mu$ .

Thorax.— Sides of the prothorax brown, the mesothorax brown or black. Length of the pterostigma from the base of the radial sector to the anterior margin of the fore wing 0.7-0.9 times the distance from the end of the pterostigma to the end of the radial sector (fig. 7); the medial vein of the fore wing once branched, the hind wing with two oblique veins. Legs brown or black, the basal part of the femora paler, the femora, the distal part of the tibiae, the first tarsal segments, and especially the second tarsal segments with spinulose imbrications, the spinulae 2-4  $\mu$  long. The tibia of the fore leg 305-375  $\mu$  long, 0.77-0.99 times as long as the width of the head across the eyes, length of the distal hairs of the hind tibia 25-35  $\mu$ ; all first tarsal segments usually with three hairs, but sometimes with two or four, the lateral hairs of the fore tarsus 1.2-2.9 times as long as the middle hair; length of the hairs of first tarsal segments of the hind leg 47-60  $\mu$ ; second tarsal segment of the hind leg with two dorsoapical hairs with expanded tips, 49-57  $\mu$  long, the tips 4-5  $\mu$  wide; length of the empodial hair of the hind leg 30-33  $\mu$ . Length of the hind segments: femur fused with trochanter 316-352  $\mu$ ; tibia 377-468  $\mu$ , 1.19-1.35 times as long as the femur, and 0.97-1.24 times the width of the head across the eyes; first tarsal segment 35-43  $\mu$  long, second tarsal segment 88-98  $\mu$ .

Abdomen.— (fig. 8). Abdominal segments I-IV colourless, V with a small marginal pale brown sclerite, VI a pale brown marginal sclerite joined with the sclerite of the siphunculi, the dorsum colourless; segment VII pale brown marginal sclerites and the dorsum with a pale brown transverse elongate patch with spinulose imbrications on the posterior part; VIII pale brown, spotted and with some spinulose imbrications; number of hairs on tergite III, 3-5; IV three, 10-20  $\mu$  long; V three; VI and VII two; VIII, 4-7, 16-27  $\mu$  long. Siphunculi located on tergite VI, around the pore with a pale brown sclerite extending 20-30  $\mu$  outside the pore, with an irregular outside border, spotted and with some concentric wrinkles, sometimes with one hair; the pore brown, about 15  $\mu$  above the surrounding area, diameter of the pore, 45-50  $\mu$  without a flange. Cauda distinctly knobbed, e.g. at the base 116  $\mu$  wide, diameter of the constriction 35  $\mu$ , the length of the knob from the constriction 40  $\mu$ , and 53  $\mu$  wide; the knob 44-58  $\mu$  wide, with 10-11 hairs, the longest 37-48  $\mu$ . Subanal plate bilobed, with 16 hairs, the longest 47-57  $\mu$ . Subgenital plate with 12-16 anterior hairs, 23-31  $\mu$  long, and 12-15 posterior hairs, 25-35  $\mu$  long. Gonapophyses two, each with 5-8 hairs, the longest 20-22  $\mu$ . Spiracula on each of the abdominal segments II-VII.

Host plant records.— Specimens were collected in Java from *Blumea* spec., Nongkodjadjar, Mt. Tengger (1200 m), IX-1913, leg. P. v.d. Goot (Van der Goot, 1917), and Garoet (750 m), maybe *Blumea* spec., a small weed, 13.viii.1916, leg. P. v.d. Goot, in the collection at the British Museum (Natural History), London.

The aphids live on the flower stems and flower stalks.

Etymology.— Blumeae, from *Blumea*, a genus of Compositae, name given by Van der Goot (1917).

**Genus *Astegopteryx* Karsch, 1890**  
(figs. 9-158)

*Astegopteryx* Karsch, 1890: 51 (type species: *Astegopteryx styracophila* Karsch, 1890).

*Oregma* Buckton, 1893: 87.

*Trichoregma* Takahashi, 1929: 252.

*Pseudoastegopteryx* Ghosh, Pal & Raychaudhuri, 1974: 109.

Karsch (1890) described *Astegopteryx styracophila* from Java, and in the following section another new species of *Astegopteryx* is described that inhabits galls of *Styrax benzoin* Dryand. Hille Ris Lambers (1953) concluded that alatae from the *Styrax* galls migrate to bamboos and *Cocos*. This conception is also shared in this publication because alatae from *Styrax* galls have embryos similar to first stage larvae from *Astegopteryx* spp. from bamboo and *Cocos*, and because in seven of the 12 species described in the following, from bamboo and *Cocos*, some of the alatae had embryos with characters of apterae from *Styrax* galls; the lack of horns and wax glands in these embryos is striking in these characters. To date direct evidence of this migration is lacking, and on the basis of characters of embryos only, I am unable to decide which *Astegopteryx* species it is; even in the case of *A. setigera* nov. spec. the alatae without doubt had to migrate to bamboo because in life the embryos show green spots on the abdomen, but which *Astegopteryx* species it is remains undecided.

Description (14 species).— I. Morphs from galls of *Styrax* L. (two species). Apterous viviparous female. Body 1.0-1.6 mm long, 1.1-2.3 times as long as it is wide. Head dorsally smooth, without horns, anteriorly and ventrally with four or more than eight spines, 6-18  $\mu$  long. Antennae with four or five segments, 0.16-0.26 times as long as the body, and 0.8-1.1 times the width of the head across the eyes. Eyes with three ommatidia. Ultimate rostral segment without accessory hairs, 0.83-1.00 times as long as the second tarsal segment of the hind leg; stylets 170-196  $\mu$  long. Prothorax fused with the head. Tibiae smooth, the fore tibia 0.61-0.96 times as long as the width of the head across the eyes. First tarsal segment of the fore- and midleg with 3-4 hairs, of the hind leg with 2-3. Second tarsal segments with two dorsoapical hairs with expanded tips. Empodial hairs 8-25  $\mu$  long, or absent.

Abdomen.— Colourless without wax gland groups, but linear S-shaped wax glands present on segments I-VI or VII. Siphunculi present. Cauda transversely elongate with an indistinct constriction or without a constriction, with 8-16 hairs. Subanal plate without or with an indistinct median incision, with 9-15 hairs. Subgenital plate with 3-5 anterior hairs, and 5-12 posterior hairs. Gonapophyses two, each with 2-6 hairs.

Alate viviparous female.— Body length 1.3-2.1 mm. Head without horns, but with 6-15 small hairs, 4-10  $\mu$  long, in two areas dorsal and lateral to the median ocellus, or 32-40 small hairs, 4-6  $\mu$  long, also present in the median area. Antennae with five segments, 1.4-1.9 times as long as the body, segments III-V with ring-shaped annular rhinaria, segment III with 11-25; IV, 6-15; and V, 4-11. The last rostral segment without accessory hairs, 60-83  $\mu$  long, 0.73-0.96 times as long as the second



tarsal segment of the hind leg; length of the stylets 180-220  $\mu$ . The medial vein of the fore wing once branched, the hind wing with two oblique veins. The tibiae smooth or with almost smooth imbrications at the distal part. First tarsal segment of fore- and midleg with 3-4 hairs, of the hind leg with two. The second tarsal segment of the hind leg with one dorsoapical hair with an expanded tip. Abdominal segments I-V colourless, VI-VIII sometimes with pale brown patches; tergites I-V with 4-9 hairs, VI with 2-3, VII usually with two, VIII with 4-6, 35-60  $\mu$  long. Siphunculi located on segment VI, almost colourless, about 15  $\mu$  high, with 3-7 hairs. Cauda transversely elongate, without a constriction, with 9-17 hairs. Subanal plate bilobed, with 9-17 hairs. Subgenital plate with 4-9 anterior hairs, and 5-25 posterior hairs. Gonapophyses two, each with 5-9 hairs.

First stage larvae of apterae with four spines on the head, or with 26-33 spines, and without siphunculi. Second stage larvae are of two types: I with smaller spines on the head than first stage larvae, and with normal last rostral segment, and type II with enlarged frontal spines, and a longer last rostral segment.

Embryos in alatae have two frontal horns provided with small hairs, and groups of marginal wax glands, the glands in a straight line with parallel partition walls, or some glands triangular or wedge-shaped; between the groups a space between the segments.

## II. Morphs from bamboos (Gramineae), Palmae, Pandanaceae and Zingiberaceae.

Apterous viviparous female. In life: Yellow sometimes more whitish grey or brown with, in species from bamboo, frequently a pattern of green; or brownish orange, red or dark violet. A wax fringe along the whole margin of the body, sometimes also columns of wax on the dorsum, or the whole dorsum covered with a layer of woolly wax or wax powder; wax columns can be lacking in specimens of old populations.

Macerated specimens.— Body length 0.9-2.2 mm. Length of the head plus the pronotum 0.6-0.8 times as long as the width of the pronotum; the head dorsally smooth with two horns with 4-12 hairs which increase in length to the base of the horns; the horns 10-110  $\mu$  long, tapering or with parallel sides, the tips pointed or rounded. Antennae with four or five segments, 185-550  $\mu$  long, 0.15-0.31 times as long as the length of the body, and 0.6-1.6 times the width of the head across the eyes; the last antennal segment 2-6 times as long as the processus terminalis. The eyes with three ommatidia. Ultimate rostral segment 0.52-0.92 times as long as the second tarsal segment of the hind leg; stylets 195-322  $\mu$  long. The prothorax fused with the head, the area along the posterior margin of the pronotum smooth or almost smooth, without swellings which fall sharply at the anterior and posterior sides. The body with a furrow posterior to the pronotum, and the meso- and metanotum more or less discernible; the meso- and metanotum with 4-12 and 4-10 hairs respectively. First tarsal segments of the fore- and midleg with 2-4 hairs, of the hind leg with two or exceptionally with three. The second tarsus of the hind leg with 1-2 dorsoapical hairs with expanded tips. The empodial hair 20-40  $\mu$  long, but in some species shorter or absent. The thorax and abdomen dorsally colourless, but in *A. rappardi* each tergite with a brown transverse band, interrupted sometimes in the middle. Number of hairs on tergite I, 4-16; II, 3-18; III, 2-19; IV, 2-26; V, 2-20; VI, 2-7; VII, 2-4; VIII, 4-12; on IV, 16-88  $\mu$  long, on VIII, 33-97  $\mu$ . Siphunculi cone-shaped colourless or brown with 2-28 hairs on the cone. Cauda transversely elongate, with a knob and a constriction,

with 5-15 hairs. Subanal plate bilobed, with 12-26 hairs, the longest 35-70  $\mu$ . Subgenital plate with 2-6 anterior hairs, and 2-18 posterior hairs. Gonapophyses two, each with 1-8 hairs, the longest 4-28  $\mu$ . Wax gland groups may occur on each of the 12 segments of the body: on the head medial to the eyes, on abdominal tergite VIII along the posterior margin, on the other segments marginally; spinal wax gland groups do not occur in *Astegopteryx*. In most species the glands are in a group and arranged in a longitudinal straight line, frequently pressed close to each other, and are then rectangular with rounded corners. In *A. rappardi* one or more glands of segments I-VI are strongly wedge-shaped and arranged in a curved line; in *A. glandulosa* the glands are arranged on segments I-VII more or less in a transverse direction, in an oval group. The number of glands in a group frequently amount to four, the highest number on the head comes to eight, on thoracic and abdominal segments to seven, but on abdominal segment I to five, on VIII to nine. Linear s-shaped wax glands are distinct ventromarginally e.g. in *A. muiri* and *A. pandani*; separate oval wax glands with irregular borders, and without angular facets occur e.g. in *A. nipae*.

In several species marked differences exist between specimens of initial populations and old populations with alatae: the length of the body of specimens in old populations is increased by about 30%, and the ratio of the length of antennae, horns and tibiae to the width of the head across the eyes increases to about the same percentage. But most striking is the change in wax glands: the glands decrease in size and number, the first on the head, thorax and anterior abdominal segments, and in *A. bambusae*, *A. basalis*, *A. glandulosa*, *A. muiri* some glands always remained on the posterior abdominal segments. In *A. minuta*, *A. pallida* and *A. rhapsidis* wax glands are completely absent in several specimens of old populations.

First stage larvae of apterae are without siphunculi.

Alate viviparous female. In life: Wholly black or dark brown, sometimes brownish orange, or the thorax yellow or dirty brown or with green. Sometimes antennae and legs greyish and the cauda yellow. Eyes black or red. Wings in a horizontal position, the pterostigma grey, dark green or black.

Macerated specimens.— Body length 1.1-2.2 mm, with two frontal horns, up to 65  $\mu$  long, with small hairs, or the horns are lacking but with 6-15 small hairs, 4-10  $\mu$  long on two areas dorsal and lateral to the median ocellus. Antennae with five segments, 0.29-0.58 times as long as the body, and 1.3-2.5 times the width of the head across the eyes; the tip of segment V distally to the ultimate rhinarium 5-58  $\mu$  long. Antennal segments III-V with ring-shaped secondary rhinaria; between the rhinaria 2-5 concentric ring-shaped spinulose imbrications, the primary rhinaria between the annular rhinaria and moulded with these to a complex structure; segment III with 10-43, IV with 6-25, V with 4-18 annular rhinaria. Last rostral segment 0.52-0.96 times as long as the second tarsal segment of the hind leg; length of stylets 185-283  $\mu$ . Eyes compound. Fore wing medial vein once branched, the hind wing with two oblique veins. First tarsal segment of the fore leg with 3-4 hairs, of the midleg with 2-4, of the hind leg with 2-3; second tarsal segment of the hind leg with 1-2 dorsoapical hairs expanded at the tips. Abdominal segments I-V colourless but sometimes a small marginal brown sclerite on segments IV-V and also a pair of small sclerites with a hair. Segment VI-VII usually with marginal sclerites and the tergites with a transversely elongate sclerite, which on VI is usually interrupted; tergite VIII nearly always with a pale brown transverse elongate sclerite. Tergite V between the siphunculi with 2-16 hairs, VIII with 3-12 hairs, 28-84  $\mu$  long. Siphunculi located on segment

V, colourless or pale brown, with 2-21 hairs. Cauda transversely elongate with a constriction, with 5-17 hairs. Subanal plate bilobed, with 12-23 hairs, the longest 29-67  $\mu$ . Subgenital plate with 4-7 anterior hairs, and 5-20 posterior hairs. Gonapophyses two, each with 4-13 hairs, the longest 8-23  $\mu$ .

The embryos in the abdomen of the alatae look like first stage larvae of apterae, or the embryos have no horns and no wax glands, while the hairs are short, blunt, 8-18  $\mu$  long on head and body (*A. bambusae*, *A. pallida*); or on the body are more sturdy hairs with expanded tips, 25-45  $\mu$  long, and on the head some spines, 8-10  $\mu$  or 15-22  $\mu$  long (*A. basalis*, *A. nipae*, *A. rhapsidis*). Siphunculi are lacking.

Etymology.— *Astegopteryx*: Wings without sloping roofs, referring to the horizontal position of the wings in rest, name given by Karsch (1890).

***Astegopteryx bambusae* (Buckton, 1893)**  
(figs. 9-22)

*Oregma bambusae* Buckton, 1893: 87.

*Cerataphis insularis* Van der Goot, 1912: 325, **syn. nov.**

*Oregma lutescens* Van der Goot, 1917: 197; Eastop & Hille Ris Lambers, 1976: 96 (synonymy).

*Oregma similis* Van der Goot, 1917: 223, **syn. nov.**

*Oregma striata* Van der Goot, 1917: 226, **syn. nov.**

*Astegopteryx bambusae*; Doncaster, 1966: 157; Eastop & Hille Ris Lambers, 1976: 96 (synonymy).

Type material.— Lectotype (apterous viviparous female, here designated) *Oregma bambusae* Buckton, *Bambusa arundinaria* India: Dehra. "Buckton Collection, slide no. 53 a.; lectotype and paralectotypes with the same data as the lectotype in the collection at the British Museum (Natural History), London. Lectotype (aptera vivipara fem.)". *Cerataphis insularis*: Semarang.xi.1909, leg. E. Jacobson, plant unknown, mounted D. Noordam, 1980; lectotype (here designated) and paralectotypes (seven apterae viviparae fem., one alata vivipara fem.) in the collection at the Rijksmuseum van Natuurlijke Historie, Leiden, the Netherlands. Material of *O. lutescens* and *O. similis* lost. Lectotype of *Oregma striata* (here designated) bamboo, Bogor, leg. P. v.d. Goot, det. P. v.d. Goot: *Oregma striata*, paralectotypes, 40 apterae viviparae same data as lectotypes, and fragments of three apterae viviparae, bamboo, Pasoeroean 1912, leg. P. v.d. Goot, det. P. v.d. Goot *Serrataphis striatus*, and of 25 apterae viviparae in 5 slides, bamboo, Salatiga, 20.viii.1914, leg. P. v.d. Goot, det. P. v.d. Goot *Oregma striata*; lectotype and paralectotypes in the collection at the Laboratorium voor Entomologie, Wageningen.

Van der Goot (1917) describes five species of *Oregma* with frontal horns with rounded tips. Two of these *O. minuta* and *O. insularis* can easily be distinguished from the others in life on the basis of the green markings on the body. The apterae of the three other species *O. lutescens*, *O. similis*, and *O. striata*, were distinguished by Van der Goot in life as follows: *O. lutescens* (compare pl. 3) a fairly indistinct green transversal band on abdominal segments I, V and VI; *O. similis* (compare pl. 4) a dark green transverse band on the metathorax, abdominal segments I, II, V, VI, and two small spots on VII, while the siphunculi are broadly surrounded by an orange yellow colour; *O. striata* (compare pl. 1) according to Van der Goot, and mentioned only in the key on p. 174, is similar to *O. similis*, but the siphunculi are surrounded

by light or dark green. In my collections nos. 239, 737 and 1209 seem to be distinctly *O. lutescens*; nos. 1108 and 1212 *O. similis*; and nos. 248, 423, 1089 and 1195 *O. striata*. But in addition to these, countless specimens show markings intermediate to those described by Van der Goot. Because no microscopic characters are connected with the colour varieties I consider that all belong to *A. bambusae*. A fourth colour variety (pl. 5) will be described below and named *maculata*. Under host range records the colour variety is added to each collection. In the introduction to *A. unimaculata* it is explained why *Cerataphis insularis* Van der Goot, 1912 is considered to be *A. bambusae*.

Apterous viviparous female.— In life: Head and prothorax yellow, greyish yellow or pale brown. Antennae yellow, the processus terminalis grey or even black. Eyes black. Legs colourless, whitish or yellowish with grey knees and tarsi. The primary colour of mesothorax, metathorax and abdomen is yellow, but sometimes whitish yellow, pale greenish or brownish yellow. Green markings are usually present, most striking as a solid patch on metathorax and abdominal segments I and II, and a second patch around and between the siphunculi which has a continuation pleurally on abdominal segment VII (pl. 1). Van der Goot (1917) called the specimens with such markings *Oregma striata*. In specimens of other populations this green may partly be absent or is so pale that it is hardly perceptible and in some specimens no green is observable, pl. 2. The green pattern in pl. 3 corresponds with the description made by Van der Goot (1917) of *Oregma lutescens*; and pl. 4 with that of *Oregma similis*. Aphids with such a colour pattern can be present in vast amounts on bamboo. Another colour variety referred to here as *maculata* shows only green spots on metathorax and abdominal segment I and no green on the margins of the body; it occurs in some collections as adults of small size, being present in a few specimens together pl. 5: it may be assumed that these adults developed from larvae deposited on the leaves by alatae. The siphunculi if not surrounded by green is usually slightly more ochre-coloured; the pore is frequently seen as a brown or reddish brown ring. Wax, in all colour varieties, is present as a fringe at the margin of head, thorax and abdomen, but is sometimes lacking on the head. In the small adults (mentioned above) with green spots, the wax is much more luxuriant, and may even be present as a white spinal and pleural line or as transverse bars on several segments (pl. 5).

Macerated specimens.— (figs. 9-12; described from 21 specimens, but from 200 specimens from 40 collections for some characters): Body broadly pear-shaped or oval, 1.19-1.95 mm long. Head across the eyes 288-418  $\mu$  wide, smooth, pale brown, the frontal hairs acute, 24-50  $\mu$  long; frontal horns triangular to finger-shaped with parallel sides, with rounded tips and bearing 8-12 hairs which increase in length to the base of the horns, 3-40  $\mu$  long; length of horns 46-93  $\mu$ , 0.14-0.27 times as long as the width of the head across the eyes. A group of wax glands may be present medial to the eyes with 1-6 glands; but the glands were lacking on one or both sides in 58 of the 145 specimens; especially in populations with alatae the glands are frequently absent. If glands are present they are situated between the eye and one hair on a low swelling, mainly conspicuous due to the anterior border which is usually seen as a ridge. Antennae (figs. 10, 11) with four or five segments, 210-470  $\mu$  long, 0.15-0.28 times as long as the body, and 0.7-1.3 times the width of the head across the eyes; antennae pale brown, the last segment brown. Antennae smooth, only the last segment with some imbrications. Antennal segment III, and in antennae with five segments III + IV with 3-8 hairs, 22-40  $\mu$  long. In antennae with four segments III is 1.3-1.9 times the length of IV; in antennae with five segments III is 1.6-2.3 times as long

as IV, and III + IV is 1.9-2.2 times as long as V. Length of antennal segments in four-segmented antennae: III, 85-215  $\mu$ ; IV, 64-112  $\mu$ . In five-segmented antennae: III, 130-170  $\mu$ ; IV, 75-93  $\mu$ , and V, 109-125  $\mu$ . Ultimate rostral segment 46-68  $\mu$  long, 0.61-0.80 times the length of the second tarsal segment of the hind leg, longest distal hairs 24-34  $\mu$ , without accessory hairs; stylets 200-275  $\mu$  long. Eyes brown with three ommatidia.

The head is fused with the pronotum and usually bears 18 hairs, six of which on the pronotum. A group of wax glands in a line or in a more or less roundish group is present marginally on the posterior side of the prothorax; the group has 2-8 glands, usually 2-5. Mesothorax and metathorax each with two marginal hairs on each side, dorsally near to the wax gland groups; on the mesothorax each group of glands consists of 3-7 (sometimes 8-13 small glands), on the metathorax 1-10 glands. Mesonotum with 4-10 dorsal hairs, metanotum with 4-8. Legs colourless or pale brown, the tarsi slightly darker, smooth, only the second tarsal segments with some imbrications. First tarsal segments with 3, 2, 2 hairs. Length of hairs of the hind tibia at the distal part 30-50  $\mu$ , of the first tarsal segment of the hind leg 34-46  $\mu$ , dorsoapical hairs of the second tarsal segments with expanded tips, of the hind leg 42-54  $\mu$  long; empodial hairs 25-40  $\mu$  long. The tibia of the fore leg 0.55-1.1 times as long as the width of the head across the eyes. Length of segments of hind leg: femur plus trochanter 226-407  $\mu$ , tibia 263-542  $\mu$ , first tarsal segment 30-38  $\mu$ , second tarsal segment 72-96  $\mu$ .

Abdominal segments marginally with colourless or pale brown sclerites with one hair dorsal to the wax glands; number of hairs on tergites: I, 5-9; II, 7-12; III, 7-11; IV, 7-12; V, 3-7; VI, 2-3; VII, 0-2; VIII, 6-11. Length of hairs on tergite IV, 30-67  $\mu$ , the head across the eyes is 5-11 times longer than these hairs; length of hairs ventrally on abdominal segment IV, 16-32  $\mu$ , on tergite VIII, 62-93  $\mu$ . Wax glands on colourless or pale brown marginal sclerites, arranged in a line or sometimes on anterior segments in a roundish group. On abdominal segment I the glands in a group number 2-4; on II, 3-6; on III, 2-6; IV, 2-6; V, 1-7, but usually one on the anterior, and one on the posterior side of the siphunculus; VI, 3-5; VII, 3-5; VIII two groups of 1-6. The wax glands are usually somewhat angular, being pressed close to each other, the larger ones have a diameter of 20-40  $\mu$ ; in populations with alatae, however, several wax glands are roundish with spaces between the glands. In one specimen out of 150 wax glands were lacking on abdominal segment III, in two specimens on IV, and in one specimen on VI, but in all specimens wax glands were present on at least 10 segments of the body. The diameter of the largest wax gland of abdominal segment VIII in specimens of 39 collections varied from 20-35  $\mu$ , of abdominal segments III to VII from 25-50  $\mu$ . Siphunculi cone-shaped, 30-75  $\mu$  elevated, the pore brown, the cone pale brown, with 4-13 hairs; diameter of the pore 50-90  $\mu$ . Cauda transversely elongate, e.g. 32  $\mu$  long, the knob 90  $\mu$  wide, and the constriction 60  $\mu$  wide, with 6-10 hairs, the longest 40-58  $\mu$ ; knob of cauda 65-110  $\mu$  wide. Subanal plate bilobed, with 12-20 hairs, the longest 50-66  $\mu$ . Subgenital plate with four anterior hairs, the longest 22-33  $\mu$ , and 4-15 posterior hairs, the longest 16-48  $\mu$ . Gonapophyses two, each with 1-5 fine hairs, 2-12  $\mu$  long. Abdominal spiracles on six segments, II-VII.

Alate viviparous female.— In life: Head, meso- and metanotum brown or black. Prothorax yellow with pleurally a brownish patch. Antennal segments I and II whitish or grey, the rest of the antennae dark grey or black. Eyes black. Marginal part of meso- and metathorax yellow with brown, and a narrow line between meso- and metanotum yellow. Legs greyish. Wings in horizontal position with blackish green

pterostigma. Abdomen yellow with a solid dark green patch on the dorsum and margins of abdominal segments I and II; the middle of II more or less with a yellow incision posteriorly; posterior margin of segment IV, segment V between the siphunculi, and two pleural patches on VI dark green; sometimes some green around the siphunculi. In some populations the green on the abdomen is pale, or even not observable. Embryos in the abdomen, well visible from the ventral side are yellow with red eyes, and four green patches anteriorly on the abdomen and two posteriorly. Later stages of larvae of alatae are easily distinguished from apterae by the presence of two green patches on the mesonotum and sometimes also on abdominal segment VII. The migrant described later on showed the same colour as that described above.

Macerated specimens.— (figs. 13-20; described from 17 specimens, some characters from 100 specimens from 15 collections). Body 1.33-2.13 mm long. Head across eyes 330-440  $\mu$  wide, smooth, dark brown, the frontal hairs dorsally to the horns acute 19-44  $\mu$  long; head dorsally anterior to the lateral ocelli with 4-8 hairs, posterior to the ocelli with 4-8. Frontal horns as in apterae but smaller, 20-65  $\mu$  long, 0.05-0.17 times as long as the width of the head across the eyes. Antennae 5-segmented, 600-800  $\mu$  long, 0.34-0.53 times as long as the body, and 1.5-2.1 times the width of the head across the eyes; segments I and II brown, paler than the head; segment I smooth with only some wrinkles; segment II with about 5-10 longitudinal ridges and transversely spinulose imbrications, more of these on the ventral side, the spinulae 1-3  $\mu$  long. Antennal segments III-V with ring-shaped secondary rhinaria, the ring is not closed on the dorsal side over a length of 2-20  $\mu$ ; between the rhinaria are three concentric ring-shaped spinulose imbrications with, usually only on the dorsal side, interconnections; ventrally the imbrications look like dotted lines, the dots with a diameter of one  $\mu$  or less; dorsally the spinulae are acute, 1-4  $\mu$  long; the rhinaria are about three  $\mu$  wide, the intervals 5-10  $\mu$ . The primary rhinaria are between the annular rhinaria and are frequently moulded with them to form a complex structure; Segment III with 28-39, IV with 10-17, V with 9-17 annular rhinaria. Hairs usually on the dorsal side, acute, segment III with 4-6 (in one specimen with two only), IV with three or sometimes four, V with two, and with five setae on top of the processus terminalis. Length of hairs on segment III, 10-20  $\mu$ . Length of segment III, 274-390  $\mu$ ; of IV, 108-165  $\mu$ ; of V, 120-180  $\mu$ ; the tip of V distally to the rhinaria 12-25  $\mu$ . Antennal segment III is 2.0-3.0 times as long as IV, 1.7-2.5 as long as V, segment IV is 0.75-1.25 times as long as V. Last rostral segment and stylet as in apterae. Eyes compound, with the ocular tubercle extending sideways 20-25  $\mu$ .

Prothorax pale brown, the median area colourless; two marginal hairs on each side, and usually on the pronotum anteriorly four hairs and posteriorly 5-7. Mesonotum dark brown, the anterior margin with two processi triangular with broadly rounded tips and wide bases, e.g. 12  $\mu$  high and 25  $\mu$  wide as the base; hairs 25-38  $\mu$  long. Fore wing medial vein once branched, the hind wing with two oblique veins. Legs brown, the distal dorsal side of femora, knees and dorsal side of the tibiae slightly darker, smooth, the second tarsal segments only slightly imbricated; hairs acute, on the tibia of the hind leg 25-35  $\mu$  long. First tarsal segments of the fore leg with three hairs, of the midleg with 2-3, of the hind leg with two; second tarsal segments dorsoapically with one hair longer than the other and expanded at the tip. Length of hind segments: femur, fused with trochanter 372-447  $\mu$ , tibia 517-607  $\mu$ , first tarsal segment 29-40  $\mu$ , second tarsal segment 86-97  $\mu$ . The tibia of the fore leg

1.0-1.2 times as long as the width of the head across the eyes, the hind tibia is 1.27-1.40 times as long as the hind femur plus trochanter.

Abdominal dorsum without segmental borders, abdominal tergites (fig. 19) I-V colourless; VI with small pale brown marginal sclerites and the tergite with a pale brown patch which may be split up into four patches with 2-3 hairs; VII with pale brown marginal sclerites which also spread to the dorsum and is sometimes present as a transverse band with the two dorsal hairs; VIII has one solid pale brown patch with 6-10 hairs, and posterior to the hairs at about 1/3 of the width of the segment on each side a processus, four  $\mu$  high and five  $\mu$  wide at the base; frequently some wax gland structures on VIII, and all sclerites have at the most indistinct imbrications; length of hairs on segment IV dorsally 24-38  $\mu$ , ventrally 18-26  $\mu$ , on tergite VIII, 50-84  $\mu$ . Siphunculi (fig. 20) pale brown, the ring brown, cone-shaped, e.g. 60  $\mu$  high with a diameter of the pore 65  $\mu$ , and the base 120  $\mu$  wide; on the cone 8-13 hairs, the longest 33-73  $\mu$ ; the diameter of the pore is 48-72  $\mu$ , of the base 76-155  $\mu$ . Cauda colourless, the knob about 23  $\mu$  long and 58-88  $\mu$  wide, with 7-11 hairs, the longest 40-50  $\mu$ . Subanal plate colourless, bilobed, with 16-23 hairs, the longest 42-52  $\mu$ . Subgenital plate almost colourless, with anteriorly four hairs, 26-36  $\mu$  long, and posteriorly 12-18 hairs, 32-42  $\mu$  long. Gonapophyses two, each with 4-11 hairs, 8-20  $\mu$  long. Abdominal spiracles on seven segments, II-VIII.

First stage larva of aptera (fig. 21; description of one specimen):

Body length 710  $\mu$ , length of head plus pronotum 200  $\mu$ ; head across eyes 224  $\mu$  wide, anterior to the eyes dorsally four hairs in a transverse row, about 48  $\mu$  long, and anterior to this transverse row up to the horns 2-3 hairs about 35  $\mu$  long. Antennae with four segments, 195  $\mu$  long, segment III, 63  $\mu$  long; IV, 76  $\mu$ , and the processus terminalis 28  $\mu$ ; length of hair on segment II, 29  $\mu$ ; on III, 38  $\mu$ . Horns pointed, 50  $\mu$  long and about 40  $\mu$  wide at the base. Tibia of the fore leg 170  $\mu$  long, length of distal hairs of all tibiae about 45  $\mu$ . All first tarsal segments with two hairs, 45-55  $\mu$  long. Second tarsal segment of the fore leg with one dorsoapical hair expanded at the tip, of mid- and hind leg with two. Wax gland groups on the head and all segments of thorax and abdomen or, especially in specimens from populations with alatae, lacking on the head, and one or two separate glands on abdominal segment V. Abdominal tergites I-V with four hairs, VI with two or exceptionally three, VII and VIII with two. Siphunculi are lacking.

The embryos in the abdomen of all, except one, alatae look like first stage larvae of the populations from bamboo. In one population, however, an alata is present which is different: embryos (fig. 22) in the body have no horns, presumably no wax glands, and on the body are hairs with a knob, 14  $\mu$  long; in normal alatae the embryos have horns, wax gland groups, and acute hairs on the body, 35  $\mu$  long. The alata differs from the description of alate viviparous females in the following points: Length of the antennae 550  $\mu$ , 0.33 times as long as the body, and 1.46 times as long as the head across the eyes. Antennal segment III, 231-245  $\mu$  long, with 20-22 rhinaria; siphunculi with 7-8 hairs; subgenital plate posteriorly with nine hairs.

From studying the embryos it must be assumed that this alata ought to migrate from bamboo presumably to *Styrax*. Van der Goot (1917) described *Oregma similis* (Van der Goot, 1917); the colour in life, the short antennae and the presence of 23 rhinaria on antennal segment III raises the question of whether his alatae were not the same as the alata described here, but proof is lacking for Van der Goot's material has been lost.

Host plant records.— Specimens were collected in Java from the following host plants, in the places and on the dates indicated, while the collectors are indicated by numbers between parentheses: E. Jacobson (1), in the collection at the Rijksmuseum van Natuurlijke Historie, Leiden; Van der Goot or Van der Goot (1917) (2), in the collection at the Laboratorium voor Entomologie, Wageningen, or lost; F.W. Rappard (3), in the collection at the British Museum (Natural History), London; and D. Noordam (4), in the collection at the Rijksmuseum van Natuurlijke Historie, Leiden. If the colour variety is known an L is added for *lutescens*, M for *maculata*, Si for *similis*, and S for *striata*. Plant unknown, Semarang.xi.1909 (1); bamboo, Sembir, Salatiga, Tjoerboek, Kopeng-Mt. Merbaboe, 1400 m, Oengaran-Bandung; Bogor, 29.viii.1917; Linggadjadi, 25.vii.1919, all (2, L); bamboo Salatiga-Warak, X-1914 (2, Si); bamboo, Pasoeroean X-1912; Salatiga, 20.viii.1914, Bogor, all (2, S); *Gigantochloa apus* (Bl. ex Schult.f.) Kurz, Banjoewangi, 8.vi.1948 (3); bamboo, Litjin-Banjoewangi (500 m), 11.x.1948 (3, ? L); bamboo "serit", Banjoewangi (400 m), 30.x.1948 (3, ? M); bamboo, Banjoewangi (0 m), 13.xi.1948 (3, S); bamboo, Litjin-Banjoewangi (450 m), 29.xi.1948 (3, L); bamboo, Blora-Rembang (60 m), 23.i.1949, 29.ii.1949 (3, L); bamboo, Badean-Djember (300 m), 1.x.1949 (3, S); bamboo, Badean-Djember (300 m), 1.x.1949 (3, L); *Gigantochloa spec.*, Bondowoso (250 m), 16.xi.1949 (3, L); *Gigantochloa apus* (Bl. ex Schult.f.) Kurz, Mt. Rayap-Djember (550 m), 3.xii.1949 (3, Si); *Bambusa blumeana* Bl. ex Schult.f., Tjoerah Dami-Bondowoso, 7.ii.1950 (3, L); *Bambusa blumeana* Bl. ex Schult.f., Bondowoso (250 m), 25.iv.1950 (3, L); *Bambusa blumeana* Bl. ex Schult.f., Bondowoso (250 m), 11.v.1950, (3, L); *Bambusa blumeana* Bl. ex Schult.f., Bondowoso (250 m), 30.v.1950 (3, L); bamboo, Gondang-Djember (600 m), 21.vii.1950 (3, ? M); *Bambusa blumeana* Bl. ex Schult.f., Bondowoso (250 m), 28.vii.1950 (3, L); bamboo, Gombang, Banjuwangi (300 m), 8.viii.1950 (3, S); bamboo, Djampit (1550 m), 5.ix.1950 (3, S); *Gigantochloa apus* (Bl. ex Schult.f.) Kurz, Mt. Rayap-Djember (550 m), 13.x.1950, (3, Si); bamboo, Mt. Rayap-Djember (550 m), 5.xi.1950 (3, S or M); *Bambusa blumeana* Bl. ex Schult.f., Malang (450 m), 20.i.1951 (3, L); *Bambusa vulgaris* Schrad., Bogor, Kebun Raya, 30.iii.1975 (4, S); bamboo, Bogor, Kebun Raya, 1.iv.1975 (4, L); bamboo, Bogor, 6.iv.1975 (4, S); bamboo, Bogor, Kebun Raya, 12.iv.1975 (4, L); bamboo, Bogor, 13.iv.1975 (4, S); bamboo, Sindanglaya (1100 m), 2.vi.1975 (4, S); bamboo, Bogor, Kebun Raya, 8.vi.1975 (4, L); bamboo, Salak-Bogor, 14.vi.1975 (4, L); *Bambusa glaucescens* (Lamk) Munro ex Merr., Krawang, 16.viii.1975 (4, L); bamboo, Sindanglaya (1100 m), 21.x.1975 (4, S); bamboo, Sindanglaya (1100 m), 21.x.1975 (4, L); bamboo, Sindanglaya (1100 m), 21.x.1975 (4, L, S); bamboo, Sindanglaya (1100 m), 5.xi.1975 (4, S); bamboo, Bogor, Kebun Raya, 23.ii.1976 (4, S); bamboo, Semplak-Bogor, 9.v.1976 (4, S); *Bambusa glaucescens* (Lamk) Munro ex Merr., Semplak-Bogor, 9.v.1976 (4, S); bamboo, Ciomas-Bogor, 5.ix.1976 (4, S); bamboo, Sindanglaya, 6.ix.1976 (4, L) bamboo, Bogor, Kebun Raya, 9.ix.1976 (4, L); bamboo, Bogor, Kebun Raya, 23.xii.1976 (4, S); ; bamboo, Sindanglaya (1100 m), 7.ix.1977 (4, S); bamboo, Sindanglaya (1100 m), 31.x.1977 (4, S); bamboo Sindanglaya (1100 m), 2.xi.1977 (4, L); bamboo, Sindanglaya (1100 m), 2.xi.1977 (4, S); bamboo, Sindanglaya (1100 m), 10.xi.1977 (4, S to Si); bamboo, Cipanas (1000 m), 14.xi.1977 (4, L); bamboo, Sindanglaya (1100 m), 15.xi.1977 (4, L); *Bambusa blumeana* Bl. ex Schult.f., Lawang (500 m), 25.xii.1977 (4, M); bamboo, Lawang (500 m), 27.xii.1977 (4, Si); bamboo, Lawang (500 m), 27.xii.1977 (4, M); *Bambusa blumeana* Bl. ex Schult.f., Lawang (500 m), 27.xii.1977 (4, L); bamboo, Lawang (500 m), 27.xii.1977 (4, S); bamboo, Lawang (500 m),



28.xii.1977 (4, S); bamboo, Lawang (500 m), 28.xii.1977 (4, L); bamboo, Lawang (500 m), 28.xii.1977 (4, Sito S); *Bambusa vulgaris* Schrad., Purwodadi (300 m), 29.xii.1977 (4, Si to S); *Bambusa blumeana* Bl., ex Schult.f. Pasuruan (0 m), 30.xii.1977 (4, no. 1220, 1222, M; no. 1221, L); bamboo, Bandung (800 m), 2.i.1978 (4, M); bamboo, Bandung (800 m), 2.i.1978 (4, S); bamboo, Cianjur, 2.i.1978 (4, S); bamboo, Bogor, Kebun Raya, 8.i.1978 (4, S); bamboo Cipanas-Garut (800 m), 6.ii.1978 (4, S, Si).

Alatae were observed by Van der Goot (1917) from the middle of September to the end of October, and one collection of *O. striata* in December 1912. Dr. Rappard collected alatae (compare Host plant records) 13.xi.1948, 23.i.1949, 1.x.1949, 25.iv.1950, 11.v.1950. The author collected alatae 13.iv., 21.x, 5.xi.1975; 6.ix., 7.ix., 31.x., 2.xi., 10.xi., 14.xi., 15.xi., 27.xii., 28.xii., 29.xii., 30.xii.1977; 2.i., 6.ii.1978. Many alatae were present from October to the end of December, but some also in February, April and May.

Apterae, single or at the most two together were observed at the end of December 1977 on the lower side of the leaf blade; they were small, 1.3-1.4 mm and only occasionally was a larva at the same place; I assume that new born larvae moved to the base of the leaf blade, for the smallest populations are found densely crowded on parts of leaves. Large populations are spread all over the lower sides of leaves, so that they are present on many culms of the tree, and upper sides of leaves are black caused by sooty moulds. The solitary adult apterae are small and characterized by being covered with wax not only at the margins of the body but also on the dorsal side of thorax and abdomen; strangely, all the solitary aphids observed showed only two green patches on the first abdominal segment and it would be interesting to find out if in later generations of populations more green appears on the body. *A. bambusae* (next to *A. pallida*) is the most common aphid found on bamboo.

Etymology.— *Bambusae*, of *Bambusa*, the typical genus of bamboos, name given by Buckton (1893).

Discussion.— The *Astegopteryx* species living on other hosts than *Styrax* are divided into two groups by an unmistakable characteristic, namely horns with a rounded tip or a pointed tip. On Java three species belong to the group with rounded horn tips: *A. bambusae*, *A. minuta* and *A. unimaculata*, which species are recognizable beyond any doubt on the basis of colour pattern in life (pls 1-5; 8; 18). The size and the disappearance of wax glands in *A. minuta* are sound microscopic characteristics to distinguish many specimens of *A. minuta* from *A. bambusae* and *A. unimaculata*, but I hesitate to state that the other characteristics mentioned in the keys of apterae and alatae are workable to distinguish the three species from each other. The apterae described in this publication fit well to the paralectotypes existing; characters in life however are unknown of the material described by Doncaster (1966).

### *Astegopteryx basalis* (Van der Goot, 1917) (figs. 23-35)

*Oregma basalis* Van der Goot, 1917: 181.

*Trichoregma flava* Takahashi, 1950: 600, *syn. nov.*

*Trichoregma malaccensis* Takahashi, 1950: 600, *syn. nov.*

*Trichoregma vandermeermohri* Takahashi, 1935: 4, *syn. nov.*

*Astegopteryx basalis*; Eastop & Hille Ris Lambers, 1976: 96 (synonymy).

Types.— Lectotype (apterous viviparous female here designated) from bamboo, Soember, Java, 10.x.1914, leg. P. v.d. Goot, no. 36-1-1), Det. P. v.d. Goot *Oregma basalis*. Paralectotypes: 49 apterae viviparae, partly fragmentary, on 25 slides with the same data as the lectotype but dates 10.x.1914 and 11.x.1914. Lectotype and paralectotypes in the collection at the Laboratorium voor Entomologie, Wageningen.

Apterous viviparous female.— In life (pl. 6): Head white, yellowish or dirty yellow. Thorax yellow. Antennae and legs white or yellowish. Abdomen red, brownish red or blackish red, the margins and around the siphunculi usually darker, the last abdominal segment yellowish. Rather short columns of wax at the margins of the body, usually present only on the abdominal segments and the metathorax, but in some populations also on mesothorax, prothorax and head. Eyes black. Larvae are very pale yellowish white, the red appears with age around the siphunculi, and gradually spreads over the whole abdomen, but the median area remains paler than the lateral sides. A colour variety exists which is yellow with only some red around the siphunculi (Van der Goot, 1917: 181, and leg. D. Noordam, no. 747, 9.ix.1976); Takahashi (1950: 600) describes *Trichoregma flava*, which is stated to be entirely yellow.

Macerated specimens.— (figs. 23, 24; described from 33 specimens): Body length 1.07-1.73 mm. Head across the eyes 270-430  $\mu$  wide, pale brown, frontal part and anterior side of the eyes somewhat wrinkled. Horns (figs. 25, 26) with coarse imbrications, usually pointing slightly downwards, with slightly convex sides, and pointed tips, all hairs small, up to about eight  $\mu$  long; length of horns 30-55  $\mu$ , 0.09-0.16 times as long as the width of the head across the eyes. Wax glands are lacking on the head, but would possibly be present on specimens of newly started populations because larvae of such populations have distinct wax glands on the head. Antennae almost colourless 185-325  $\mu$  long, 0.10-0.21 times as long as the body, 0.65-0.85 times the width of the head across the eyes, with four or five segments. Antennal segment III in four-segmented antennae or III + IV in five-segmented antennae, is 0.18-0.41 times as long as the head across the eyes. Length of antennal segments in four-segmented antennae: III, 62-119  $\mu$ ; IV, 51-66  $\mu$ ; In five-segmented antennae: III, 56-114  $\mu$ ; IV, 48-65  $\mu$ ; and V, 70-86  $\mu$ . Ultimate rostral segment 54-70  $\mu$  long, 0.73-0.92 times the length of the second tarsal segment of the hind leg; stylets 218-267  $\mu$  long. Number of wax glands on prothorax 0-2, on mesothorax 0-2, and on metathorax 0-4. Legs colourless or evenly pale brown, smooth, also the second tarsal segments almost without imbrications; tibia of fore leg 0.55-0.68 times as long as the width of the head across the eyes, and the second tarsal segment of hind leg 0.19-0.24 times. First tarsal segment of fore leg with 3-4 hairs, of midleg with 2-3, and of hind leg with two; second tarsal segment with two dorsoapical hairs expanded at the tips. Abdomen colourless, but sometimes marginal sclerites and the dorsum of abdominal segments VII and VIII pale brown. Numbers of hairs on abdominal tergites: I, 4-7; II, 4-7; III, 2-5; IV, 2-4; V two or exceptionally three, VI two, VII two; VIII, 4-6. Length of hairs on abdominal tergite IV, 28-46  $\mu$ , ventrally on abdominal segment IV, 18-40  $\mu$ , on tergite VIII, 40-56  $\mu$ . Wax glands usually angular, being pressed close to each other, and arranged in a line; number of glands on each side of segment I, 1-4; II, 2-5; III, 2-4; IV, 2-4; V, 3-4; VI, 3-4; VII, 2-4; VIII two groups of 2-5, exceptionally there is one gland more on some of the segments. Siphunculi cone-shaped, pale brown, the pore brown,

with 2-7 hairs on the cone. Cauda (fig. 27) transversely elongate, e.g. 20  $\mu$  long and 98  $\mu$  wide, almost without a constriction, usually pointing upwards in the mounts; cauda 61-100  $\mu$  wide, with 10-15 hairs. Subanal plate bilobed, with 12-21 hairs. Subgenital plate with 4-5 anterior hairs and 8-16 posterior hairs. Gonapophyses two, each with 4-6 hairs.

Alate viviparous female.— In life: Head and mesothorax blackish brown. Abdomen greyish brown. Prothorax and distal end of abdomen dark green. Antennae dark grey. Legs grey, base of the femora paler. Eyes dark red. Pterostigma grey or bluish grey. Larvae yellowish head and thorax, dirty brown abdomen with white wax fringe.

Macerated specimens.— (figs. 28-32; described from 15 specimens): Body length 1.52-2.02 mm. Head across the eyes 370-453  $\mu$  wide, smooth, dark brown, dorsally to the horns 5-10 hairs if the 3-7 hairs posterior to the paired ocelli are not included; length of the longest of these hairs 14-29  $\mu$ . Horns 6-30  $\mu$  long, usually with round tips. Antennae five-segmented, segment II with transverse, slightly spinulose imbrications. Antennal segments III-V with ring-shaped secondary rhinaria, the ring is not closed on the dorsal side over a length of 2-20  $\mu$ . The primary rhinaria are moulded with the secondary to form a complex structure. Segment III with 18-31, IV with 9-17, V with 7-14 annular rhinaria. Length of segment III, 240-315  $\mu$ ; of IV, 95-165  $\mu$ ; of V, 100-155, the tip of V distally to the rhinaria 6-14  $\mu$ . Antennal segment III is 1.6-2.6 times as long as IV, 1.9-2.6 times as long as V, 0.93-1.33 times as long as IV plus V and IV is 0.9-1.4 times as long as V. The last rostral segment is 0.78-0.96 times as long as the second tarsal segment of the hind leg; length of the stylets about 270  $\mu$ . Eyes compound. Fore wing medial vein once branched, the hind wing with two oblique veins. Legs brown, the distal part of the femora, and the basal part of the tibiae slightly darker, smooth, but the second tarsal segments slightly imbricated. First tarsal segments of fore leg with 3-4 hairs, of midleg with 2-3, of hind leg with two; second tarsal segment of hind leg dorsoapically with one hair longer than the others and expanded at the tip. The tibia of the fore leg is 0.8-1.0 times as long as the width of the head across the eyes. Abdomen colourless, but marginally a small pale brown patch on segments III-V may be present, and larger patches on VI and VII, two small pale brown patches on tergite V, two larger ones on VI, and a transverse band on VII and VIII; tergites V, VI and VII each with two hairs, VIII with four, or exceptionally with three; length of the spinal hairs of tergite VIII, 35-48  $\mu$ , the lateral are usually slightly longer. Siphunculi located on abdominal segment V, brown, cone-shaped, about 40  $\mu$  high, at the base 120-160  $\mu$  wide, the pore with a diameter of 25-41  $\mu$ , the cone with concentric spinulose imbrications or ridges, with 2-5 hairs, 20-30  $\mu$  long. Cauda transversely elongate, e.g. 35  $\mu$  long and 82  $\mu$  wide, a knob 76-88  $\mu$  wide almost without a constriction, with 11-17 hairs, 49-69  $\mu$  long. Subanal plate bilobed with 21-23 hairs, the longest 48-67  $\mu$ . Subgenital plate anteriorly with 4-5 hairs, the longest 25-39  $\mu$ , posteriorly with 12-20 hairs, the longest 31-43  $\mu$ . Gonapophyses two, each with 7-13 hairs, the longest 12-20  $\mu$ .

The embryos and first stage larvae of apterae (fig. 33) have horns, dorsally to the horns are two rows of four hairs, the second row just anterior to the eyes; these hairs narrow towards the tip, with a small head; length of hairs of the second row 40  $\mu$ ; mesonotum and metanotum each with four hairs, all abdominal tergites with two hairs; wax glands are usually lacking on the head and on some thorax segments, but

larvae (fig. 33) of populations which seem to be just starting to develop have wax glands on the 12 segments of the body, and also on the head. Embryos in alatae collections were the same as in apterae, but in one collection some embryos (figs. 34, 35) had no horns, no wax glands, no stylets, and dorsal hairs on head, thorax and abdomen are thick, widened in the basal half, and capitate; marginal hairs on thorax and abdomen are of the same shape.

Host plant records.— Specimens were collected in Java from the following host plants in the places and on the dates indicated, while the collectors are indicated by numbers between parentheses: Van der Goot or Van der Goot (1917) (1) in the collection at the Laboratorium voor Entomologie, Wageningen, or lost; P. Büchner (2) in the collection at the British Museum (Natural History), London; D. Noordam (3) in the collection at the Rijksmuseum van Natuurlijke Historie, Leiden.

Bamboo, Soember (Sembir), 10 and 11.x.1914 (1); bamboo Salatiga (570 m) (1); bamboo, Bogor, 19.x.1919 (1); bamboo, Bogor, 1.vi.30.vii.1956, B5, 12 (2); bamboo, Bogor, Kebun Raya, 12.iv.1975 (3); *Dendrocalamus asper* (Schult.f.) Backer ex Heyne, 8.v.1975 (3); bamboo, Bogor, Kebun Raya, 7.vi.1975 (3); bamboo, Sindanglaya (1100 m), 5.xi.1975 (3); bamboo, Sindanglaya (1100 m), 6.ix.1976 (3); bamboo, Bogor, Kebun Raya, 9.ix.1976, 29.ix.1976, 23.xii.1976 (3); bamboo, Sindanglaya (1100 m), 15.xi.1977 (3).

This aphid lives on the lower side of leaves, on the basal two cm of the leaf blade only at altitudes of 250-1100 m. As a result of its habit to colonize only on two cm, together with the whitish yellow colour of most of the specimens of a population, this species can be identified from as far away as two metres. Specimens which could be close to the start of a population (characterized by small size and presence of wax glands, in any case in larvae, also on the head) were collected at the beginning of June. Alatae were collected 10.x.1914, 19.x.1919, 5.xi.1975, 29.ii.1976, 29.ix.1976, 15.xi.1977, and alatae with embryos differing from those of apterae were from this last date.

Etymology.— *Basalis*, at or near to the base. Undoubtedly, Van der Goot (1917) gave this name because this particular aphid is only found at the base of the leaf, a characteristic mentioned emphatically by Van der Goot.

Discussion.— The colour in life, the fact that it lives on the base of leaves only, the small number of hairs on the siphunculi and on abdominal segments, the numerous hairs on cauda and genital plate in alatae are some of the characters which differentiate *A. basalis* from other species. Takahashi (1935) described *Trichoregma vandermeermohri*, collected from Sumatra, stating that it differs from *T. basalis* van der Goot in possessing wax-pores on the thorax and in the fact that the third antennal joint of the alate form is much longer than the fourth and fifth taken together and with more sensoria, as well as in smaller cornicles. When, however, specimens of more collections of *A. basalis* are taken into account than was done by Van der Goot, all characters Takahashi described for *T. vandermeermohri* agree with those of *A. basalis*. Takahashi described two other species, *T. flava* Takahashi, 1950, and *T. malaccensis* Takahashi, 1950 from the Malay peninsula. *T. flava* is similar to the yellow colour variety already mentioned in this paper; paratypes of the two species are present in the aphid collection of D. Hille Ris Lambers (British Museum), comparing these with *A. basalis* I concluded that the two species are not different from specimens of *A. basalis* and so the two species are considered to be synonyms of *A. basalis*.

***Astegopteryx glandulosa* spec. nov.**  
(figs. 36-45)

**Types.**— Holotype (apterous viviparous female) from bamboo, Sindanglaya, Java, Indonesia no. 812-3-1, 16.xii.1976, leg. D. Noordam. Paratypes: 90 apterae viviparae and 11 alatae viviparae, same locality and host plant as holotype, no. 812, 16.vii.1976, no. 740, 6.ix.1976, leg. D. Noordam; Linggadjati, 25.vii.1919, leg. P. van der Goot; bamboo, Badean, Djember, no. 162, 163, 21.i.1950; no. 199, 8.vii.1950, leg. F.W. Rappard. Bamboo, Meerzicht-West, New Guinea, no. 6, 12.ix.1954; no. 13, 12.ix.1954; no. 45, 30.v.1955, all three leg. F.W. Rappard. Holotype and paratypes leg. D. Noordam in the collection at the Rijksmuseum van Natuurlijke Historie, Leiden; paratype leg. Van der Goot at the Laboratorium voor Entomologie, Wageningen; paratypes, leg. F.W. Rappard at the British Museum (Natural History), London.

Apterous viviparous female.— In life (pl. 7): Head, thorax and abdomen yellow, the abdomen with some orange in the shape of two lines in length or as some spots or as marbling; the end of the abdomen without orange. Antennae white or grey. Legs yellow. Eyes black. Wholly covered with a thin layer of woolly wax, and sometimes thicker bars of wax at the margins and especially at the end of the body. New born larvae are bright yellow, and later stages develop some orange spots. The leaf is also covered with white powder.

Macerated specimens.— (figs. 36, 37; described from 17 specimens): Body length 1.20-1.53 mm. Head across the eyes 235-335  $\mu$  wide, colourless, pale brown or in collections with alatae sometimes brown, smooth. Horns narrowed to the tip, frequently pointed, hairs at the tip about four  $\mu$  long, at the base eight  $\mu$ ; length of horns 10-25  $\mu$ , 0.04-0.08 times as long as the width of the head across the eyes; wax glands 1-3 on each side, spherical or oval, not touching each other; in collections with alatae wax glands are sometimes lacking on one or both sides of the head. Dorsal to the horns usually eight hairs anterior to the eyes and 10-12 posterior to the eyes; length of longest hairs 52-80  $\mu$ . Antennae four- or five-segmented colourless, evenly pale brown or in populations with alatae sometimes brown, 305-422  $\mu$  long, 0.22-0.28 times as long as the body, 1.0-1.4 times the width of the head across the eyes. Antennal segment III in four-segmented antennae, or III + IV in five-segmented antennae, 0.49-0.62 times as long as the width of the head across the eyes. Length of antennal segments in four-segmented antennae: III, 126-167  $\mu$ ; IV, 95-117  $\mu$ ; in five-segmented antennae: III, 85-118  $\mu$ ; IV, 54-81  $\mu$ ; V, 95-121  $\mu$ , with the processus terminalis 25-32  $\mu$  long. Antennal segments III-V with some spinulose imbrications, especially on the ventral side. Eyes with three ommatidia on a brown slightly extending tubercle. Ultimate rostral segment 53-62  $\mu$  long, 0.55-0.77 times the length of the second tarsal segment of the hind leg; stylets 219-244  $\mu$  long.

Prothorax fused with the head, marginally with 0-5 wax glands. Mesothorax colourless but in populations with alatae, marginal sclerites and two patches on dorsum sometimes brown, 0-5 marginal wax glands, and the mesonotum with 4-11 hairs. Metathorax colourless, marginally with 0-5 wax glands, the dorsum with 4-13 hairs. Legs pale brown or brown, smooth, even the tarsi; tibia of fore leg 0.84-1.02 times as long as the width of the head across the eyes, and the second tarsal segment of the hind leg 0.27-0.36 times as long. First tarsal segment of fore leg with four, exceptionally with three hairs, of midleg with 3-4, of hind leg with two; second tarsal

segment of hind leg with one dorsoapical hair expanded at the tip.

Abdomen colourless with dorsally fairly indistinct spinulose imbrications, most distinct on segment VIII and VII; the skin marginally and pleurally, and in populations with alatae sometimes also dorsally covered with sinuous lines, visible at a magnification of 400. Number of hairs on abdominal tergites: I, 4-14; II, 4-18; III, 4-19; IV, 4-25; V, 3-13; VI, 2-4; VII, 2-3; VIII, 6-12. Length of hairs on abdominal tergite IV, 47-88  $\mu$  ventrally on abdominal segment IV, 31-59  $\mu$ , on tergite VIII, 67-84  $\mu$ . Wax glands oval or somewhat angular with rounded corners, two or three frequently arranged transversely extending from the margin to the pleural side, with the dorsal marginal hair in between them; diameter of the glands 40-60  $\mu$ , but in populations with alatae 10-25  $\mu$  and located only marginally in low numbers. Number of glands on each side of segment I, 1-3; II, 2-7; III, 0-7; IV, 0-6; V, 0-7; VI, 0-7; VII, 3-6; VIII one group of 1-9 in one line, with, in the middle, a space of 0-30  $\mu$ . Siphunculi colourless, pale brown or brown, cone-shaped, 100-175  $\mu$  wide at the base, diameter of the pore 50-80  $\mu$ , on the cone 7-28 hairs. Cauda transversely elongate, e.g. the knob 39  $\mu$  long, 69  $\mu$  wide and the constriction 32  $\mu$  diameter; cauda knob 58-78  $\mu$  wide, with 9-14 hairs, the longest 23-39  $\mu$ . Subanal plate bilobed, with 14-20 hairs, the longest 47-60  $\mu$  long. Subgenital plate with 4-6 anterior hairs, the longest 25-33  $\mu$ ; and 5-12 posterior hairs, the longest 18-27  $\mu$ . Gonapophyses two, each with 3-7 hairs, 8-10  $\mu$  long.

Alate viviparous female.— In life: Head greenish grey, thorax brownish black, abdomen dark brownish orange. Antennae black. Legs pale brown, tibiae basally and distally darker; tarsi dark grey. Cauda yellowish. Eyes reddish black. Pterostigma brownish grey.

Macerated specimens.— (figs. 38-44; described from 12 specimens): Body length 1.33-1.60 mm. Head across the eyes 330-386  $\mu$  wide, smooth, dark brown, dorsally to the horns and anterior to the paired ocelli 12-20 hairs, the number being somewhat arbitrary for the indistinct border of the horns; longest hairs 18-39  $\mu$ . Horns a tiny bump or the place only marked by small hairs. Antennae five-segmented, 490-724  $\mu$  long, 0.35-0.58 times as long as the body, and 1.3-1.9 times as long as the width of the head across the eyes; segments I and II dark brown, segment I smooth with only some wrinkles; segment II with 5-10 longitudinal ridges, and transverse spinulose imbrications, dorsally at the distal end only, the spinulae two  $\mu$  long or less. Antennal segments III-V (fig. 39) with ring-shaped secondary rhinaria, the ring is not closed on the dorsal side, usually over a length of 10-20  $\mu$ ; between the rhinaria are concentric ring-shaped spinulose imbrications, usually 3-5, with interconnections. The rhinaria are about two  $\mu$  wide, the intervals 8-12  $\mu$ , or on segment V even more. The primary rhinaria are moulded with the annular rhinaria to a complex structure; segment III with 16-24, IV with 6-14, V with 4-13 annular rhinaria. Hairs usually on the dorsal side, acute, segment III with 1-3, usually two hairs; IV with 2-3, and V with two and five setae on top of the processus terminalis; length of hairs on segment III, 6-8  $\mu$ . Length of segment III, 205-306  $\mu$ ; of IV, 95-177  $\mu$ ; of V, 110-173  $\mu$ ; the tip of V distal to the rhinaria 16-58  $\mu$ . Antennal segment III is 1.6-2.5 times as long as IV, 1.4-2.1 times as long as V, and IV is 0.7-1.1 times as long as V. The last rostral segment is 0.58-0.83 times as long as the second tarsal segment of the hind leg; length of the stylets 237-253  $\mu$ . Eyes compound, with the ocular tubercle extending sideways 20-27  $\mu$ .

Prothorax pale brown, two marginal hairs on each side and on the dorsum four hairs anteriorly, and four posteriorly. Mesonotum dark brown. Fore wing (fig. 40)

medial vein once branched, the hind wing with two oblique veins. Legs brown, the apices of femora, the bases of tibiae and the tarsi somewhat darker, almost smooth, but the second tarsal segment with some spinulose imbrications; hairs acute, longest hairs on tibia of hind leg 18-22  $\mu$ . First tarsal segments (figs. 41, 42) of fore leg with four hairs, of midleg usually with three hairs, but sometimes with four, of the hind leg with two hairs; second tarsal segment of the hind leg dorsoapically with one hair longer than the other and expanded at the tip. Length of hind segments: femur, fused with trochanter, 370-413  $\mu$ , tibia 480-551  $\mu$ , first tarsal segment 27-33  $\mu$ , second tarsal segment 76-93  $\mu$ . The tibia of fore leg 0.9-1.1 times the width of the head across the eyes, the hind tibia is 1.3-1.4 times as long as the hind femur plus trochanter. Abdominal dorsum colourless, without segmental borders, segment IV with 7-11 hairs, V with 4-7, VI with 2-3, VII with two, VIII with 5-9; length of hairs dorsally on segment IV, 22-29  $\mu$ , ventrally 18-21  $\mu$ , on tergite VIII, 29-39  $\mu$ . Siphunculi located on the anterior part of abdominal segment V, colourless, the pore only very pale brown; in last stage larvae siphunculi a cone, 30  $\mu$  high, but in alatae without a cone and without a border; the pore located in an area of 100  $\mu$  long and 60  $\mu$  wide with 10-21 hairs, the hairs fairly short and curved, 15-20  $\mu$  long; diameter of the pore 33-40  $\mu$ . Cauda distinctly knobbed, the knob transversely elongate, e.g. 73  $\mu$  wide, 35  $\mu$  long, diameter of the constriction 41  $\mu$ ; cauda knob 61-73  $\mu$  wide, with 10-16 hairs, the longest 25-37  $\mu$ . Subanal plate bilobed, with 16-22 hairs, the longest 47-55  $\mu$ . Subgenital plate with anteriorly 4-7 hairs, the longest 27-39  $\mu$ , posteriorly 9-17 hairs, the longest 31-41  $\mu$ . Gonapophyses two, each with 5-9 hairs, the longest 8-14  $\mu$ .

The embryos in apterae and alatae are just as first stage larvae of apterae. First and second stage larvae of one type, no "soldiers" present.

First stage larva (fig. 45; description of one specimen): Body length 622  $\mu$ , length of head plus pronotum 208  $\mu$ , head across eyes 212  $\mu$  wide. Antennae four-segmented, 197  $\mu$  long, segment III, 69  $\mu$ ; IV, 80  $\mu$ ; length of hair on segment II, 49  $\mu$ , on III, 43  $\mu$ . Horns pointed, 102  $\mu$  long, and 27  $\mu$  wide at the base. Longest hair dorsally on head 45  $\mu$ . Tibia of the fore leg 175  $\mu$  long, of fore- and midleg with one very long distal hair, 85  $\mu$ ; two distal hairs of tibia of hind leg more sturdy, 50  $\mu$  long. All first tarsal segments with two hairs, 55  $\mu$  long. All second tarsal segments with two dorsoapical hairs which are slightly expanded at the tips. Wax glands usually on head, and all thorax and abdominal segments, usually marginally in a line, sometimes in a group; the mesothorax is the first segment where wax glands may be lacking. Abdominal tergites I-V with four hairs, VI with three, VII and VIII with two, 20-25  $\mu$  long but on tergite VIII, 40  $\mu$ ; marginal hairs are longer, up to 55  $\mu$ . Siphunculi are lacking.

Host plant records.— Specimens were collected in Java from the following plants, in the places and on the dates indicated, while the collectors are indicated by numbers between parentheses: Van der Goot (1), in the collection at the Laboratorium voor Entomologie, Wageningen; F.W. Rappard (2), in the collection at the British Museum (Natural History), London; and D. Noordam (3), in the collection at the Rijksmuseum van Natuurlijke Historie, Leiden. Bamboo, Linggadjadi, 25-VII-1919 (1); bamboo, Badean-Djember (350 m), 21.i.1950 (2); bamboo, Badean-Djember (350 m), 8.vii.1950 (2); bamboo, Sindanglaya (1100 m), 6.ix.1976 (3); bamboo, Sindanglaya (1100 m), 16.xii.1976 (3).

Alatae were observed 25.vii.1919 and 16.xii.1976.

The aphids are on the lower side of the leaves, producing so much wax that part

of the leaf is covered with it; lower leaves are frequently covered with black sooty moulds. Collections were at altitudes of sea-level to 1100 m.

Etymology.— Glandulosa, gland-bearing, the name D. Hille Ris Lambers intended to give to this species because it has many, sometimes very large, wax gland groups.

***Astegopteryx minuta* (Van der Goot, 1917)**  
(figs. 46-52)

*Oregma minuta* Van der Goot, 1917: 201.

*Astegopteryx minuta*; Eastop & Hille Ris Lambers, 1976: 97 (synonymy).

Types.— Lectotype (apterous viviparous female, here designated) from bamboo, Ilejteh, Java, 1913, leg. P. van der Goot, *Cerataphis minutus* det. P. v.d. Goot, no. 273-1-1. Paralectotypes four, two on the same slide, two on another slide and fragments on a third slide, same data as the lectotype. Lectotype and paralectotypes in the collection at the Laboratorium voor Entomologie, Wageningen, the Netherlands.

Apterous viviparous female.— In life (pl. 8): Pale yellow, very pale green or dirty white or yellow with two green lines from medial to the eyes up to the lateral sides of abdominal segment VIII. The lines widen to the margins on metathorax, abdominal segments I and II, and in some populations even on all abdominal segments. On metanotum and abdominal segment I the green continues in the middle and shapes a more or less continuous transverse band. Between the siphunculi the lines are also widened to the middle, but usually remain interrupted by a yellow colour in the middle. The siphunculi, and anterior to the siphunculi, the body is more orange yellow, if not green. First stage larvae have only four small green spots, two on metanotum plus abdominal segments I and II, and two on abdominal segment VI. A fringe of wax may be present on all segments of the body but, especially in large populations, may be lacking on some or even all segments.

Macerated specimens.— (figs. 46-48; described from 15 specimens, some characteristic from 120 specimens out of 16 collections). The characters determined conform in such a way to those of *Astegopteryx bambusae* that for the description the reader is referred to *A. bambusae*; here only some characters which were shown to differ from those of *A. bambusae* are mentioned. Length of body 1.11-1.81 mm, head across eyes 302-382  $\mu$ . The horns 0.15-0.25 times as long as the width of the head across the eyes. The knob of the cauda 55-83  $\mu$  wide. In specimens from some collections, the wax glands are present in lower numbers than ever found in *A. bambusae*, and can be lacking completely on some segments or even on all segments of the body, while a decrease in number is coupled with a reduction in size of the wax glands. The numbers of wax glands observed on the segments of the body are: head 0-4, prothorax 0-5, mesothorax 0-7, metathorax 0-5, abdominal segment I, 0-4; II, 0-5; III, 0-5; IV, 0-5; V, 0-5; VI, 0-4; VII, 0-5; and VIII on each side 0-6. In one collection, of 2.xi.1977 wax glands were lacking on all segments of the body; in ten collections the largest diameter of wax glands on abdominal segment VIII was 7-18  $\mu$ , and on segments III-VII 12-26  $\mu$ . In one collection (no. 421, 21.x.1975), however, in which larvae of alatae were also present, the largest diameter of wax glands on segment VIII was 20-28  $\mu$ , on seg-



ments III-VII, 30-38  $\mu$ ; the specimens from this collection could not be distinguished from specimens of *A. bambusae*, except by the colour in life. Specimens from this collection were characterized by the length of the antennae being 1.1-1.2 times the width of the head across the eyes, and the tibiae of the fore leg 0.9-1.1 times as long as the width of the head.

Alate viviparous female.— In life described by Van der Goot (1917), apparently only differing from *A. bambusae* by two longitudinal dark green lines between the siphunculi.

Macerated specimens.— (figs. 49-52; described from two specimens from two collections by F.W. Rappard, 31.v.1948 and 5.ix.1948). Body 1.56-1.70 mm long. Head dark brown, smooth, across the eyes 350-380  $\mu$  wide, length of the horns 20-30  $\mu$ ; the frons dorsal to the horns with 5-8 hairs, 20-22  $\mu$  long, posterior to the paired ocelli 4-6 hairs. Frontal horns as in apterae but smaller, 20-30  $\mu$  long, 0.06-0.07 times as long as the width of the head across the eyes. Antennae with five segments, 492-570  $\mu$  long (Van der Goot, 1917: 740  $\mu$ ), 0.31-0.33 times as long as the body, and 1.5-1.6 times the width of the head across the eyes; segments I and II brown, I with some wrinkles, II with some longitudinal ridges, and spinulose imbrications, mainly on the ventral side; segments III-V with ring-shaped secondary rhinaria, the ring is not closed on the dorsal side over a length of 2-20  $\mu$ ; between the rhinaria are 3-4 concentric ring-shaped spinulose imbrications with interconnections usually only on the dorsal side; the rhinaria are 3-4  $\mu$  wide, the intervals 5-10  $\mu$ ; The primary rhinaria are between the annular rhinaria and are moulded with these to a complex structure; segment III with 24-26 annular rhinaria, IV with 8-9, V with 8-9 (Van der Goot, 1917: III with 28, IV with 13, V with 10); segments III and IV each with two hairs, 9-14  $\mu$  long, V with one, and apically with five setae; length of segment III, 230-275  $\mu$ , 2.7-2.9 times as long as IV, and 2.0-2.3 times as long as V, length of IV, 80-100  $\mu$ , 0.70-0.83 times as long as V, the tip distal to the last rhinarium 13-23  $\mu$  long. Last rostral segment 60-65  $\mu$  long, 0.74-0.76 times the length of the second tarsal segment of the hind leg. Eyes compound, with the ocular tubercle extending sideways 20-25  $\mu$ . Fore wing medial vein once branched, the hind wing with two oblique veins. Legs brown, smooth, the second tarsal segments with some imbrications with a few spinulae; longest hairs on the hind tibia 25-31  $\mu$ . First tarsal segments of the fore leg with three hairs, the lateral hairs 2.3-2.9 times as long as the middle hair, of the midleg and hind leg each with two hairs; those of the hind leg 43-61  $\mu$  long. Second tarsal segments dorsoapically with one hair longer than the other and with an expanded tip 43-44  $\mu$  long, the tip 3-4  $\mu$  wide. Length of hind segments: femur, fused with trochanter 346-385  $\mu$ , tibia 480-520  $\mu$ , first tarsal segment 31-35  $\mu$ , second tarsal segment 81-86  $\mu$ . The tibia of the fore leg 1.1 times as long as the width of the head across the eyes. Abdominal segments I-V dorsally colourless, IV with six hairs, about 25  $\mu$  long; VI with a small marginal pale brown sclerite; VII with a pale brown patch on the dorsum; VIII with a pale brown transverse elongate patch with some indistinct spinulose imbrications, and with six hairs, 55-70  $\mu$  long. Siphunculi pale brown, cone-shaped, about 30  $\mu$  high, and 100  $\mu$  wide at the base; on the cone seven hairs, 28-40  $\mu$  long, diameter of the pore 43-45  $\mu$ . Cauda colourless, the knob 25  $\mu$  long and 60  $\mu$  wide, with 9-10 hairs, the longest 35-40  $\mu$ . Subanal plate colourless, bilobed, with 12-14 hairs, the longest 40-51  $\mu$ . Subgenital plate almost colourless, with four anterior hairs, 31-35  $\mu$  long, and 10-11 posterior hairs, 38-53  $\mu$  long. Gonapophyses two, each with 5-7 hairs, 12-16  $\mu$  long.

Host plant records.— Specimens were collected in Java from the following plants, in the places and on the dates indicated, while the collectors are indicated by numbers between parentheses: Van der Goot or Van der Goot (1917) (1), in the collection at the Laboratorium voor Entomologie, Wageningen or lost; F.W. Rappard (2), in the collection at the British Museum (Natural History), London; and D. Noordam (3), in the collection at the Rijksmuseum van Natuurlijke Historie, Leiden. Bamboo, Kepoeh (sea level); Warak (550 m); Soekamangli, Selokaton (500 m); Gogodalem (260 m); Buitenzorg (250 m), Mt. Telemojo (1200 m), 1912-1915 (1); Ilejteh, 1913 (1); bamboo, Soember, 12.ix.1916 (1); bamboo, Bogor, 25.vii.1918 (1); *Gigantochloa apus* (Bl. ex Schult.f.) Kurz, Banjoewangi (0 m), 31.v.1948, 5.ix.1948, 27.x.1948; *Bambusa blumeana* Bl. ex Schult.f., Bondowoso (250 m) (1); *Dendrocalamus asper* (Schult.f.) Backer ex Heyne, Bogor, Kebun Raya, 1.iv.1975 (3); bamboo, Bogor, 4.iv.1975 (3); bamboo, Bogor, 20.iv.1975 (3); bamboo, Bogor, Kebun Raya, 1.v.1975, 8.v.1975 (3); bamboo, Sindanglaya (1100 m), 21.x.1975 (3); *Dendrocalamus asper* (Schult.f.) Backer ex Heyne, Bogor, Kebun Raya, 22.xii.1976 (3); bamboo, Cipayung (600 m), 30.iv.1977 (3); bamboo Tjiawi-Bogor (500 m), 30.iv.1977 (3); bamboo, Sindanglaya (1100 m), 2.xi.1977; *Bambusa blumeana* Bl. ex Schult.f., Lawang (500 m), 25.xii.1977, 29.xii.1977 (3).

This aphid lives on the lower side of leaves, at altitudes of 0-1200 m. Small populations are restricted to the base of the leaf blade, larger populations are spread out over the leaves.

Alatae were collected viii.1913, x.1914; vii.1915; 12.ix.1916, 31.v.1948, 5.ix.1948, 21.x.1975 (larva).

Etymology.— *Minuta*, very small, name given by Van der Goot (1917).

### ***Astegopteryx muiri* (Van der Goot, 1918)** (figs. 53-64)

*Oregma muiri* Van der Goot, 1918: 117.

*Astegopteryx muiri*; Eastop & Hille Ris Lambers, 1976: 97.

Types.— Van der Goot's original material has been lost.

Van der Goot (1918) collected this species in Singapore and states that it may be easily distinguished from *Astegopteryx nipae* (Van der Goot, 1917) by the larger distance between the groups of glands along the hind margin of abdominal tergite VIII, being about the breadth of one gland in *A. muiri* and only a hairbreadth in *A. nipae*. This and other characters mentioned by Van der Goot are insufficient to distinguish the two species from each other. The key in the present paper gives some other characters by which the species can be distinguished on more grounds than the difference in host plants. The material from Singapore is lost, but in 1919 and 1920 Van der Goot collected the species at Bogor, and this material is in the collection at the Laboratorium voor Entomologie, Wageningen.

Apterous viviparous female.— In life (pl. 9): Head, horns, antennae, and legs whitish or pale brown, distal part of antennae grey. Abdomen brown, close to the siphunculi frequently darker; the brown may have a dark violet hue if some wax covers the dorsum. Pronotum and mesonotum colour as the head, colour of metanotum becoming darker to the posterior side.

Head and prothorax with a column of wax on each side pointing obliquely upwards, abdomen with thick wax columns marginally on each segment; the dorsum of thorax and abdomen with some wax powder or on every segment with a narrow white transverse band, most distinct on the pleural sides. Eyes black. Larvae yellow, gradually turning to the colour of the adult specimens. In *A. nipae* distinct transverse wax bands were not observed, but a reliable difference between *A. nipae* and *A. mui-ri* is not known.

Macerated specimens.— (figs. 53-56; described from 15 specimens): Body length 0.87-1.32 mm. Head across eyes 222-320  $\mu$  wide, very pale brown, smooth. Horns with somewhat lumpy sides, but with a long, smooth, sharp, point, hairs 5-8  $\mu$  long; length of horns 42-65  $\mu$ , 2-3 times as long as they are wide at base, 0.17-0.24 times as long as the width of the head across the eyes. Wax glands about in a straight line medial to the eyes with 3-7 glands; largest diameter of the glands 15-35  $\mu$ . Separate oval wax glands on the median area of head, thorax and abdomen indistinct. Length of longest hairs dorsally on the head 29-45  $\mu$ . Antennae with four or five segments, pale brown, the last segment slightly darker, 215-350  $\mu$  long, 0.21-0.30 times as long as the body, 0.9-1.2 times the width of the head across the eyes. Antennal segment III in four-segmented antennae, or III plus IV in five-segmented antennae, 0.34-0.54 times as long as the width of the head across the eyes. Length of antennal segments in four-segmented antennae: III, 86-150  $\mu$ ; IV, 76-98  $\mu$ ; in five-segmented antennae: III, 83-105  $\mu$ ; IV, 58-68  $\mu$ ; and V, 93-106  $\mu$ ; the processus terminalis about 20-25  $\mu$  long. Last antennal segment distally with smooth imbrications, and spinulae around the rhinarium, otherwise segments I-V smooth. Eyes same colour as the head, with three ommatidia. Ultimate rostral segment 50-65  $\mu$  long, 0.63-0.77 times as long as the second tarsal segment of the hind leg; stylets 218-260  $\mu$  long. Prothorax fused with the head, marginally with 3-6 wax glands. Mesothorax and metathorax almost colourless, each with about 4-8 hairs, marginal wax glands on mesothorax and metathorax 3-6; some specimens, in one collection with alatae, without wax glands, which are also lacking on prothorax, head and several abdominal segments. Legs evenly very pale brown, the tarsi not darker, smooth, even the tarsi; tibia of fore leg 0.69-0.86 times as long as the width of the head across eyes; longest hair of basal half of tibia of hind leg 31-55  $\mu$ ; the second tarsal segment of hind leg 72-96  $\mu$  long, 0.23-0.29 times as long as the tibia of hind leg, and 0.28-0.34 times the width of the head across the eyes. First tarsal segment of fore leg with three, exceptionally with two, hairs, of midleg and hind leg with two hairs; second tarsal segment of hind leg with two dorsoapical hairs, one of these hairs widened at the tip, at most two  $\mu$  wide, the other almost without a widened tip. Length of segments of hind leg: femur plus trochanter 220-342  $\mu$ , tibia 251-397  $\mu$ , first tarsal segment 29-33  $\mu$ . Abdomen colourless, smooth with some indistinct spinulose imbrications, most clearly on segments VII and VIII. Linear s-shaped wax glands (fig. 55) ventral-marginally and pleurally usually distinctly present and observable at a magnification of 200-400. Number of hairs on abdominal tergites: I, 5-7; II, 4-9; III, 5-9; IV, 4-9; V, 5-10; VI, 2-3; VII two; VIII, 5-9. Length of hairs on abdominal tergite IV; 29-41  $\mu$ , ventrally on segment IV, 18-23  $\mu$ , spinally on tergite VIII, 33-53  $\mu$ . Marginal wax glands in a straight longitudinal line, with an interval between the segments, but in each group the glands are squeezed flat against each other; number of wax glands on the segments: I, 2-4; II-VII, 3-5; VIII two groups of 5-8; the interval between the two groups of VIII, 0-35  $\mu$ ;

32 out of 64 specimens had an interval of 0-8  $\mu$ ; in a collection with alatae eight out of nine had intervals of 12-35  $\mu$ , one only seven  $\mu$ , while in a collection with apterae only, all 11 specimens had intervals of 3-8  $\mu$ . The border of the wax glands is a line, about one  $\mu$  wide, the glands with facets, only faintly observable. Largest diameter of wax glands on segment VIII about 25-43  $\mu$ , on segments III and IV 30-60  $\mu$ , but in some specimens with wax glands lacking on several segments or, if present, these are smaller. Siphunculi colourless or very pale brown, cone-shaped, about 30-40  $\mu$  high and 70-135  $\mu$  wide at the base, diameter of the pore 35-67  $\mu$ , with 2-11 hairs on the cone. Cauda (fig. 56) transversely elongate e.g. 25  $\mu$  long, 53  $\mu$  wide, and diameter of the constriction 40  $\mu$ ; knob of the cauda 40-68  $\mu$  wide, with 6-12 hairs, the longest 35-49  $\mu$ . Subanal plate bilobed, with 12-18 hairs, the longest 35-45  $\mu$ . Subgenital plate with 2-4 anterior hairs, the longest 16-25  $\mu$ , and 6-10 posterior hairs, the longest 16-25  $\mu$ . Gonapophyses two, each with 4-5 hairs, the longest 6-12  $\mu$ .

Alate viviparous female.— In life: Black. Pterostigma dark green. Last stage larvae yellow, later the abdomen greyish brown; sides of the head, antennal segments I and II, pleurae of pronotum and mesonotum, and most clearly a transverse band on abdominal segments I and II bluish green.

Macerated specimens.— (figs. 57-64; described from eight specimens): Body length 1.27-1.60 mm. Head across eyes 300-355  $\mu$  wide, smooth, dark brown, dorsal to the horns and anterior to the paired ocelli 7-12 hairs; length of the longest hairs dorsally on the head 10-17  $\mu$ . Horns a bump about 5-10  $\mu$  high with a base about 30  $\mu$  wide, with eight small hairs. Antennae five-segmented, 560-700  $\mu$  long, 0.43-0.51 times as long as the body, and 0.17-0.21 times the width of the head across the eyes; segment I pale brown, smooth; segment II brown, with some longitudinal ridges, dorsally and ventrally with spinulose imbrications, the spinulae 1-2  $\mu$  long. Antennal segments III-V with ring-shaped secondary rhinaria, the ring is not usually closed on the dorsal side, e.g. with an interval of 2-20  $\mu$ , but in some specimens the ends of the ring touch each other in some rhinaria; between the rhinaria are 2-4 concentric ring-shaped spinulose imbrications, on the dorsal side with interconnections. The rhinaria are 2-4  $\mu$  wide, the intervals 6-12  $\mu$ . The primary rhinaria are between the annular rhinaria and are moulded with these to a complex structure; segment III with 25-34, IV with 10-16, V with 10-15 annular rhinaria; hairs are usually on the dorsal side, segment III with 0-2, IV with 2-3, and V with two, and on the top of the processus terminalis five setae; length of hairs on segment III, 7-9  $\mu$ . Length of segment III, 255-350  $\mu$ ; of IV, 108-140  $\mu$ ; of V, 123-143  $\mu$ , the tip of V distally to the ultimate rhinarium 8-14  $\mu$ . Antennal segment III is 2.2-2.6 times as long as IV, 2.0-2.7 times as long as V, and 1.06-1.30 times as long as IV plus V; segment IV is 0.8-1.1 times as long as V. The last rostral segment is 0.71-0.76 times as long as the second tarsal segment of the hind leg; length of stylets 214-250  $\mu$ . Eyes compound, with the ocular tubercle extending sideways 0-20  $\mu$ .

Prothorax pale brown, mesonotum dark brown. Fore wing medial vein once branched, the hind wing with two oblique veins. Legs brown, the distal part of the femora, and the basal part of the tibiae slightly darker, almost smooth, but the second tarsal segments with some spinulose imbrications; hairs acute, longest hairs on tibia of hind leg 27-38  $\mu$ . First tarsal segments of fore leg with three hairs, of midleg and hind leg with two; second tarsal segment of hind leg dorsoapically with one hair expanded at the tip; empodial hairs 27-33  $\mu$  long. Length of hind segments: femur

fused with trochanter 322-386  $\mu$ , tibia 389-484  $\mu$ , first tarsal segment 31-35  $\mu$ , second tarsal segment 83-88  $\mu$ . The tibia of fore leg is 0.9-1.1 times as long as the width of the head across eyes, the hind tibia is 1.23-1.28 times as long as the hind femur plus trochanter; the second tarsal segment of the hind leg is 0.25-0.28 times as long as the width of the head across the eyes.

Abdominal segments colourless, segments VI-VIII with some indistinct spinulose imbrications. Number of hairs on tergites I-IV about eight, on V, 5-7; VI, 2-4; VII two; VIII, 5-7; length of hairs dorsally on segment IV, 16-27  $\mu$ , ventrally 12-16  $\mu$ ; on tergite VIII, 28-39  $\mu$ . Siphunculi located on segment V, pale brown, cone-shaped, about 25  $\mu$  high, with a diameter of the pore of 35-46  $\mu$ , the cone at the base 85-100  $\mu$  wide; on the cone 7-11 hairs, the longest 18-24  $\mu$ . Cauda colourless, transversely elongate, e.g. 58  $\mu$  wide, 24  $\mu$  long, diameter of the constriction 40  $\mu$ ; cauda knob 45-59  $\mu$  wide, with 11-13 hairs, the longest 25-43  $\mu$ . Subanal plate bilobed, with 16-20 hairs, the longest 39-45  $\mu$ . Subgenital plate with anteriorly four hairs, the longest 25-39  $\mu$ , posteriorly 8-10 hairs, the longest 29-41  $\mu$ . Gonapophyses two, each with 6-8 hairs, the longest 10-14  $\mu$ .

First stage larva of apterae (description of one specimen): Body length 590  $\mu$ , length of head plus pronotum 193  $\mu$ , head across eyes 210  $\mu$ . Antennae four-segmented, 189  $\mu$  long, length of hair on segment II, 27  $\mu$ , on III, 43  $\mu$ . Horns pointed, 49  $\mu$  long, and 23  $\mu$  wide at base. Longest hair dorsally on the head 29  $\mu$ . Tibia of fore leg 143  $\mu$  long, distal hairs of fore leg 35-60  $\mu$  long; two distal hairs of tibia of hind leg more sturdy 45  $\mu$  long. All first tarsal segments with two hairs, 45-60  $\mu$  long. Second tarsal segments of fore leg with one larger hair expanded at the tip, midleg and hind leg with two; empodial hairs 12-20  $\mu$  long, with thin ends. Wax glands on all segments of the body in a longitudinal straight line with intervals between the segments. Abdominal tergites I-V with four hairs, VI-VIII each with two; dorsal to the wax glands on abdominal segments I-VII one marginal hair; length of hairs on tergites I-VII about 20  $\mu$ , on VIII 30  $\mu$ , marginal about 30  $\mu$  long. Siphunculi are lacking.

Embryos in alatae are similar to those in apterae, with horns, wax glands, and acute hairs on the body; in a collection from 25.v.1975 the embryos have no horns, no wax glands and hairs with capitate tips on head, thorax and abdomen.

Host plant records.— Zingiberaceae, the aphid specimens collected from Java are indicated, the host plants mentioned, while the collectors are indicated by a number between parentheses: P. van der Goot (1), in the collection at the Laboratorium voor Entomologie, Wageningen; D. Noordam (2), in the collection at the Museum van Natuurlijke Historie, Leiden; F.W. Rappard (3), in the collection at the British Museum, Londen: *Alpinia* spec., 5.iii.1976, Bogor, and 6.i.1978, Bogor (2), *Amomum coccineum* (Bl.) K. Schum., 10.ix.1977, 18.xi.1977, both Bogor (2); *Hedychium coronarium* Koen., 8.ii.1920, Bogor (1); *Hornstedtia mollis* (Bl.) Valet., 18.v.1975, Mt. Salak (Bogor) at 700 m, 21.v.1975 and 25.v.1975, Bogor (2); *Nicolaia* spec., 28.viii.1919, Bogor (1); *Zingiber* spec., Mt. Kelet, 1400 m, 8.viii.1951 (3).

The aphids were on the lower sides of leaves especially along the midrib, frequently with ants.

Alatae or larvae of alatae were collected 28.viii.1919, 25.v.1975, 10.ix.1977, 19.xi.1977.

Etymology.— Muiri, name given by Van der Goot (1918) to commemorate Mr Fred Muir, entomologist from Hawaii.

***Astegopteryx nipae* (Van der Goot, 1917)**  
(figs. 65-78)

*Oregma nipae* Van der Goot, 1917: 208.

*Astegopteryx nipae*; Eastop & Hille Ris Lambers, 1976: 97.

Types.— Lectotype (apterous viviparous female, here designated) from *Nypa fruticans*, Pasoeroean, Java, Indonesia, 1913, leg. P. v.d. Goot, no. 282-25, Det. P. v.d. Goot: *Cerataphis nipae*; specimen L, 1240  $\mu$  and A, 348  $\mu$  long. Paralectotypes: five apterae viviparae, eight alatae viviparae, and larvae in the same mount as lectotype. Lectotype and paralectotype in the collection at the Laboratorium voor Entomologie, Wageningen.

Apterous viviparous female.— In life (pl. 10): Head, horns, antennae, anterior part of thorax, legs, and end of the abdomen yellow or pale brown. Abdomen brown or brownish red, frequently darker around the siphunculi. Head with two columns of wax pointing obliquely upwards; the same on the pronotum, but the columns pointing less steeply. Margins of each abdominal segment with a column of wax which may be raised upwards at the base, but the ends are frequently horizontal. The dorsum looks dull, fairly smooth, but in some populations is covered with some white wax powder. Eyes black.

Macerated specimens.— (figs. 65-68; described from 23 specimens): Body length 0.95-1.63 mm. Head across eyes 255-338  $\mu$  wide, usually pale brown, sometimes brown, frontal part and anterior side of eyes somewhat wrinkled. Horns with somewhat lumpy sides, but with a long, smooth, sharp point, with hairs, 6-8  $\mu$  long; length of horns 50-95  $\mu$ , 0.18-0.26 times as long as the width of the head across the eyes; length of the point of the horn, distal to the ultimate hair, 12-20  $\mu$ , but in one collection with the smallest specimens 7-10  $\mu$ . Wax glands in a curved line or more or less radially arranged, medial to the eyes, with 3-7 glands; largest diameter of the glands 20-30  $\mu$ . Median area of the head, and even more distinct on the median area of thorax and abdominal segments I-IV, with oval separate wax glands with an irregular outline (fig. 67) and lacking the distinct facet structure of the marginal wax glands. Length of longest hairs dorsally on the head 18-40  $\mu$ . Antennae with four or five segments, pale brown, the last segment may be darker, 202-375  $\mu$  long, 0.20-0.27 times as long as the body, 0.8-1.2 times the width of the head across the eyes. Antennal segment III in four-segmented antennae, or III + IV in five-segmented antennae, 0.30-0.56 times as long as the width of the head across the eyes. Length of antennal segments in four-segmented antennae: III, 82-153  $\mu$ ; IV, 71-95  $\mu$ ; in five-segmented antennae: III, 85-123  $\mu$  (in one specimen 67  $\mu$ ); IV, 59-65  $\mu$  (in one specimen 45  $\mu$ ), and V, 83-105  $\mu$ ; the processus terminalis about 25  $\mu$  long. Last antennal segment distally with smooth imbrications, and spinulae around the rhinarium, otherwise segments III-V smooth; antennal segment II with about 10 longitudinal ridges. Eyes slightly darker than the head, with three ommatidia. Ultimate rostral segment 48-55  $\mu$  long, 0.63-0.87 times as long as the second tarsal segment of the hind leg; stylets 195-227  $\mu$  long.

Prothorax fused with the head, marginally with 3-7 wax glands. Mesothorax and metathorax pale brown, the dorsum of each with four to about 11 hairs, marginal wax glands on mesothorax 3-7, on metathorax 2-7. Legs evenly pale brown, the tarsi

not darker, smooth, even the tarsi; tibia of fore leg 0.63-0.80 times as long as the width of the head across the eyes; the second tarsal segment of the hind leg 61-78  $\mu$  long, 0.18-0.24 times as long as the tibia of the hind leg, and 0.21-0.28 times as long as the width of the head across the eyes. First tarsal segment of fore leg usually with three, sometimes with four hairs, of midleg with two or three hairs, of the hind leg with two; second tarsal segment of the hind leg with two dorsoapical hairs expanded at the tips, distally 2.5-3  $\mu$  wide; empodial hairs of hind leg 22-31  $\mu$  long. Length of segments of hind leg: femur plus trochanter 219-318  $\mu$ , tibia 279-420  $\mu$ , first tarsal segment 27-36  $\mu$ .

Abdomen almost colourless or the dorsum and marginal wax glands pale brown, the pleural part colourless, smooth with some indistinct spinulose imbrications on segments VIII and VII; linear s-shaped wax glands sometimes present ventral-marginally, but indistinct. Number of hairs on abdominal tergites: I, 5-12; II, 4-9; III, 3-12; IV, 3-9; V, 3-8; VI, 2-5; VII, 2-3; VIII, 4-8. Length of hairs on abdominal tergite IV, 30-47  $\mu$ , ventrally on segment IV, 14-20  $\mu$ , on tergite VIII spinal hairs 36-58  $\mu$ . Wax glands on almost colourless or pale brown marginal sclerites, the glands themselves are pale brown, arranged in a straight or sometimes arched line on each segment, with an interval between the segments, but in each group the glands are squeezed flat against each other; number of wax glands on the segments: I, 3-4; II, 3-6; III, 2-5; IV, 3-6; V, 4-5; VI, 3-5 but usually four; VII four; VIII two groups of 4-6 with an interval in the middle of 0-8  $\mu$ , exceptionally more, up to 20  $\mu$ . The border of the wax glands is seen as a yellow line, about 1.5  $\mu$  wide, the gland has facets with 4-6 corners, and a diameter of 2.5-4  $\mu$ . Largest diameter of wax glands on segment VIII about 35-45  $\mu$ , on segments III and IV up to 45-55  $\mu$ . Siphunculi pale brown, distinctly darker than the abdominal tergites, cone-shaped, 15-30  $\mu$  high, 100-130  $\mu$  wide at the base, diameter of the pore 30-45  $\mu$ , with 3-7 hairs on the cone. Cauda transversely elongate, e.g. 29  $\mu$  long, 73  $\mu$  wide and diameter of the constriction 55  $\mu$ ; knob of the cauda 50-83  $\mu$  wide, with 8-14 hairs, the longest 41-63  $\mu$ . Subanal plate bilobed, with 17-22 hairs, the longest 49-67  $\mu$ . Subgenital plate with 4-5 anterior hairs, the longest 16-29  $\mu$ , and 4-14 posterior hairs, the longest 20-31  $\mu$ . Gonapophyses two, each with 5-7 hairs, the longest 6-12  $\mu$ .

Alate viviparous female.— In life: Head and thorax black, abdomen greenish black. Eyes, antennae, legs, siphunculi black. Cauda dark green. Pterostigma greenish black (Van der Goot, 1917). Larvae head, thorax, legs and antennae yellowish, abdomen brownish red.

Macerated specimens.— (figs. 69-75; described from 11 specimens): Body length 1.37-1.70 mm. Head across the eyes 350-409  $\mu$  wide, smooth, dark brown, dorsal to the horns and anterior to the paired ocelli 5-10 hairs; length of the longest hairs dorsally on the head 20-35  $\mu$ . Horns 10-55  $\mu$  long, pointed or with a round tip; horns 0.03-0.13 times as long as the width of the head across the eyes. Antennae five-segmented, 520-669  $\mu$  long, 0.34-0.42 times as long as the body, and 1.4-1.7 times the width of the head across the eyes; segment I brown, smooth; segment II brown, with some longitudinal ridges, and ventrally with some spinulose imbrications, the spinulae 1-2  $\mu$  long. Antennal segments III-V with ring-shaped secondary rhinaria, the ring is not closed on the dorsal side e.g. at the base of segment III with an interval of 15-40  $\mu$ , but in the middle 3-10  $\mu$ , or the ends of a ring even pass each other; between the rhinaria are 2-3 concentric ring-shaped spinulose imbrications, on the dorsal side

with interconnections. The rhinaria are 2-4  $\mu$  wide, the intervals 6-10  $\mu$ . The primary rhinaria are between the annular rhinaria and are moulded with these to a complex structure; segment III with 24-31, IV with 8-16, V with 6-14 annular rhinaria; hairs are usually on the dorsal side, acute, segment III with 1-2, IV with 2-3; V with two, and five setae on the top of the processus terminalis; length of hairs on segment III, 10-12  $\mu$ . Length of segment III, 200-285  $\mu$ ; of IV, 88-149  $\mu$ ; of V, 102-163  $\mu$ , the tip of V distally to the ultimate rhinarium 16-22  $\mu$ . Antennal segment III is 1.9-2.7 times as long as IV, 1.6-2.5 times as long as V, and 0.90-1.22 times as long as IV plus V; segment IV is 0.7-1.1 times as long as V. The last rostral segment is 0.66-0.76 times as long as the second tarsal segment of the hind leg; length of stylets 208-237  $\mu$ . Eyes compound, with the ocular tubercle extending sideways 18-20  $\mu$ .

Prothorax pale brown, mesonotum dark brown. Fore wing medial vein once branched, the hind wing with two oblique veins. Legs brown, the distal part of the femora, and the basal part of the tibiae slightly darker, almost smooth, but the second tarsal segments with some spinulose imbrications; hairs acute, longest hairs on tibia of hind leg 23-29  $\mu$ . First tarsal segments of the fore leg with three hairs, exceptionally with four, of midleg with 2-3, of hind leg with two; second tarsal segment of hind leg dorsoapically with two hairs expanded at the tips, distally 3-4  $\mu$  wide; empodial hairs 25-31  $\mu$  long. Length of hind segments: femur, fused with trochanter, 359-370  $\mu$ , tibia 425-472  $\mu$ , first tarsal segment 28-31  $\mu$ , second tarsal segment 69-78  $\mu$ . The tibia of the fore leg is 0.8-0.9 times as long as the width of the head across the eyes, the hind tibia is 1.18-1.31 times as long as the hind femur plus trochanter; the second tarsal segment of the hind leg is 0.17-0.22 times as long as the width of the head across the eyes.

Abdominal segments I-III colourless, IV sometimes marginally with a pale brown patch, the dorsum colourless, V-VII marginally with a pale brown patch, the tergites with a transverse pale brown patch, narrow on V, wider on VI and VII, and on VII united with the marginal patches; tergite VIII pale brown; the pale brown parts with some fairly indistinct spinulose imbrications. Number of hairs on tergite III, 7-8; IV, 5-9; V, 5-6; VI, 2-4; VII two; VIII, 4-5; length of hairs dorsally on segment IV, 33-45  $\mu$ , ventrally 18-25  $\mu$ , on tergite VIII 41-49  $\mu$ . Siphunculi located on segment V, pale brown, cone-shaped, about 30  $\mu$  high, with a diameter of the pore of 28-40  $\mu$ , the cone at the base about 100  $\mu$  wide; on the cone 4-7 hairs, the longest 25-39  $\mu$ . Cauda colourless, the knob transversely elongate, e.g. 55  $\mu$  wide, 29  $\mu$  long, diameter of the constriction 35  $\mu$ ; cauda knob 50-65  $\mu$  wide, with 11-14 hairs, the longest 53-63  $\mu$ . Subanal plate bilobed, with 20-22 hairs, the longest 51-59  $\mu$ . Subgenital plate with anteriorly four hairs, posteriorly 9-13, the longest anterior and posterior hairs 35-43  $\mu$ . Gonapophyses two, each with 7-9 hairs, the longest 10-23  $\mu$ .

First stage larva of apterae (fig. 76, description of one specimen): Body length 559  $\mu$ , length of head plus pronotum 191  $\mu$ , head across eyes 204  $\mu$ . Antennae four-segmented, 193  $\mu$  long, length of hair on segment II, 27  $\mu$ ; on III, 29  $\mu$ . Horns pointed, 45  $\mu$  long, and 27  $\mu$  wide at the base. Longest hair dorsally on the head 43  $\mu$ . Tibia of fore leg 141  $\mu$  long, distal hairs of fore leg and midleg 33-41  $\mu$  long, two distal hairs of tibia of hind leg more sturdy, 35  $\mu$  long. All first tarsal segments with two hairs, 50  $\mu$  long. Second tarsal segments of fore leg dorsoapically with one larger hair expanded at the tip, midleg and hind leg with two; empodial hairs 23-25  $\mu$  long, with expanded tips. Wax glands on all segments of the body, on the head in a curved line or oval



group, on the other segments marginally about in a longitudinal straight line with intervals between the segments; distance between the wax gland groups in the middle 6-13  $\mu$ . Abdominal tergites I-V with four hairs, VI-VIII each with two; dorsally to the wax glands on abdominal segments I-VII one marginal hair; length of hairs on tergites I-VII about 30  $\mu$ , on VIII, 40  $\mu$ . Siphunculi are lacking. First stage larvae in populations with alatae are usually larger, length of body about 650-700  $\mu$ . From sizes of larvae present it seems that the third stage larvae always develop into the adult form.

Embryos in alatae are similar to those of apterae, but in two collections (of 24.x.1948, and 15.iii.1976) embryos (figs. 77, 78) have some blunt hairs, and sometimes four dagger hairs on the head, wax glands resemble those of first stage larvae of apterae, but horns are lacking.

Host plant records.— Palms, the aphid specimens collected from Java from the following host plants, while the collectors are indicated by numbers between parentheses: P. van der Goot and Van der Goot (1917), (1), in the collection at the Laboratorium voor Entomologie, Wageningen; D. Noordam (2), in the collection at the Museum van Natuurlijke Historie, Leiden; F.W. Rappard (3), and J.P. Sijpkens (4), both in the collection at the British Museum, London: *Calamus unifarius* Wendl., 12.vi.1975, Bogor (2); *Cocos nucifera* L., Salatiga, VIII-1914 (1); Bogor, 6.x.1918 (1); Banjoewangi, 23.viii.1948, 24.x.1948, 21.xi.1948 (3); Bogor, 4.v.1975, 15.iii.1976, 16.xii.1977 (2); Lawang, 27.xii.1977 (2); *Daemonorops geniculata* (Griff.) Mart. Bogor, 11.vi.1975 (2); *Elaeis guineensis* Jacq., 1919, 8.ii.1920 (1); Siantar, 1.xi.1951 (4); *Nypa fruticans* Wurmb., 5.vi.1913 (1); *Salacca edulis* Reinw. (1); Karangasem-Bali, 28.vii.1976 (2); Sindanglaya, 4.iii.1978 (2).

The aphids live on the lower side of leaves, with ants, causing black moulds on other leaves, in a *Salacca* plantation, one palm may be completely covered with the aphids, while surrounding palms are free.

Alatae or larvae of alatae were collected 5.vi.1913, viii.1914, 6.x.1918, 24.x.1948, 1.xi.1951, 15.iv.1975, 27.iv.1975, 12.vi.1975, 15.iii.1976, 4.iii.1978.

Etymology.— *Nypae* refers to *Nypa fruticans*, the first host plant on which Van der Goot found this aphid (Van der Goot, 1917).

### *Astegopteryx pallida* (Van der Goot, 1917)

(figs. 79-99)

*Oregma pallida* Van der Goot, 1917: 212.

*Oregma salatigensis* Van der Goot, 1917: 219, *syn. nov.*

*Astegopteryx pallida*; Eastop & Hille Ris Lambers, 1976: 97.

Types.— Lectotype of *A. pallida* (apterous viviparous female, here designated) from bamboo, Kepoeh, Java, Indonesia, 1912, leg. P. van der Goot, no. 293-2, *Cerataphis pallidus*, det. P. van der Goot. Paralectotypes four, on four other slides, same data as the lectotype. Lectotype and paralectotypes in the collection at the Laboratorium voor Entomologie, Wageningen, The Netherlands.

Van der Goot (1917) described *Oregma pallida* and *Oregma salatigensis* in the same publication and was of the opinion that the almost complete absence of wax glands

in apterae of *O. salatigensis* was sufficient to distinguish this species from *O. pallida* which has wax glands usually lacking only on prothorax and mesothorax. *Oregma singaporensis*, it seems, could only be distinguished according to Van der Goot (1918) from *O. pallida* and *O. salatigensis* by the colours in life: *O. singaporensis* yellow without distinct green marks, the two other species with dark green spots on thorax and abdomen. The observation of 45 populations in life and using the microscope proved to me that only two species exist: *Astegopteryx pallida* (Van der Goot, 1917), and *A. singaporensis* (Van der Goot, 1918). Some specimens of *A. pallida*, collected by Van der Goot in 1912 on which he based the description of the species, are preserved; in no respect do these specimens differ from specimens collected by me, which on grounds of the colour in life are *A. salatigensis*. The statement by Van der Goot (1917) that the almost complete absence of wax glands in *A. salatigensis* is a usable character to distinguish the species from *A. pallida* is wrong; in initial populations *A. pallida* has wax glands on all segments of the body, but when the populations are ageing wax glands disappear more and more. So *A. salatigensis* is a synonym of *A. pallida*. Because material of *A. pallida* exists upon which Van der Goot based his description, while for *A. salatigensis* only material from later dates exists, the name *A. pallida* is used in this publication for this species. One weak point in choosing the name *pallida* is that none of the collected aphids had the colours in life described by Van der Goot; green spots were always present on abdominal segment I, and frequently on more segments; but this was probably due more to chance, because the variability in colour is great (pls 11, 12).

Apterous viviparous female.— In life (pls 11, 12): Body yellow with a pattern of green. The least green was seen a few times in a specimen sitting alone, a pair of dark green spots on the metanotum, the same on abdominal segment I, and a smaller pair on the mesonotum; the pleural and spinal parts of these segments are yellow; medial to the siphunculi a green spot is present. Abundant wax was present on the head, and margins of thorax and abdomen, but also spinally on all segments of the body, and pleurally on abdominal segments II-IV, and VI-VIII. A great variation in green patterns and wax occurs in populations of different ages: green pairs of spots may be present on 4-6 anterior segments (thoracic and abdominal) of the body, and on abdominal segments VI-VIII. The posterior part of abdominal segment III and the anterior part of IV remain free of green the longest; but in populations with alatae the whole body may be dark bluish green, except for the head, the margins of abdominal segments VI, I-IV, and thorax, and a longitudinal oval spot spinally on abdominal segments III-VI which remain yellow. The wax decreases in proportion as the green increases, remaining the longest on the last abdominal segments, but even there all wax may disappear. Eyes black. Antennae colourless, the ultimate and distal part of the penultimate segment grey or black. Legs yellowish, the tarsi grey. Siphunculi sometimes a brown ring, the cone and surroundings brownish or green. Larvae yellow with a pair of green spots on metathorax and abdominal segment I, with age more green and wax.

Macerated specimens.— (figs. 79-84; described from 18 specimens, for some characters 200 specimens from 35 collections): Body length 1.1-2.2 mm. Head across eyes 267-397  $\mu$  wide, pale brown, smooth, the frontal dorsal hairs acute, 28-50  $\mu$  long; frontal horns triangular, usually with straight sides, tips pointed, with 8-12 hairs increasing in length to the base, the basal hairs sometimes as long as the frontal dorsal

hairs; length of horns 50-110  $\mu$ , 0.17-0.30 times as long as the width of the head across the eyes. A group of wax glands with 1-5 glands was present medial to the eyes in 112 out of 198 specimens. Antennae (figs. 79-82) with four or five segments, 260-550  $\mu$  long, 0.19-0.29 times as long as the body, and 0.8-1.6 times the width of the head across the eyes; antennae pale brown or brown, the ultimate segment and sometimes the distal part of segment III darker. Antennae smooth, the ultimate segment and in antennae with five segments sometimes segment IV and the distal part of III with some imbrications. Antennal segment III, and in antennae with five segments III + IV with 3-6 hairs, 22-36  $\mu$  long. In antennae with four segments, III is 1.3-2.1 times as long as IV, and 0.26-0.39 times the width of the head across the eyes; in antennae with five segments III is 1.6-2.1 times as long as IV; and III + IV, 2.0-2.6 times as long as V. Length of antennal segments in four-segmented antennae: III, 108-240  $\mu$ ; IV, 82-125  $\mu$ ; In five-segmented antennae: III, 150-220  $\mu$ ; IV, 85-110  $\mu$ ; and V, 111-135  $\mu$ . Ultimate rostral segment 48-64  $\mu$  long, 0.54-0.74 times the length of the second tarsal segment of the hind leg, without accessory hairs; stylets 210-280  $\mu$  long. Eyes brown, with three ommatidia.

The head is fused with the pronotum and bears 18-20 hairs, or if the larger hairs at the base of the horns are included four or five more; 6-8 of the hairs are on the pronotum; wax glands are present on the prothorax in 44 out of 190 specimens, as a group of 1-6 glands, marginally on the posterior side. Wax glands on mesothorax were present in 22 specimens, and on metathorax in 62 specimens of 190; usually 1-3 glands are present in a wax gland group, sometimes more, up to six. Legs colourless, pale brown or rarely brown; especially the tarsi and the distal part of the tibiae sometimes brown, smooth or at the most the second tarsal segments with some indistinct imbrications. The tibia of the fore leg is 0.71-1.1 times as long as the width of the head across the eyes. The second tarsal segment of the hind leg is 0.24-0.28 times as long as the width of the head across the eyes. First tarsal segments with 3, 2, 2 hairs, but sometimes the tarsus of the fore leg also with two hairs. Length of hairs of the hind leg: first tarsal segment 42-58  $\mu$ , two dorsoapical hairs, expanded at the tip of second tarsal segment, 42-56  $\mu$ , empodial hair 28-36  $\mu$ . Length of segments of hind leg: femur plus trochanter 263-431  $\mu$ , tibia 306-607  $\mu$ , first tarsal segment 26-35  $\mu$ , second tarsal segment 68-94  $\mu$ .

Abdomen, also the marginal sclerites colourless; borders of marginal sclerites only distinct when distinct wax glands are present, one large hair dorsal to the wax glands on each segment I-VII; numbers of hairs on abdominal tergites: I, 5-9; II, 4-9; III, 4-8; IV, 5-8; V, 3-8; VI two; VII two, VIII, 5-8. Length of hairs on abdominal tergite IV, 50-70  $\mu$ , ventrally on abdominal segment IV, 32-50  $\mu$ , and shorter hairs 14-22  $\mu$ , on tergite VIII, 64-97  $\mu$ . Wax glands, if present, are arranged marginally on each segment in a group, on abdominal segment I the glands number 0-5; on II, 0-7; III, 0-7; IV, 0-6; V, 0-6; VI, 0-6; VII, 0-6, and VIII two groups of 0-7; the distance between the two groups on segment VIII is 65-160  $\mu$ , 0.17-0.47 times the width of the head across eyes. In some collections of small specimens wax glands are present on all segments of the body; these wax glands are somewhat angular, being pressed close to each other, the larger ones have a diameter of 25-45  $\mu$ ; in larger specimens with relatively longer antennae more and more wax glands disappear, the first from the anterior segments, but in some collections the wax glands are lacking on all segments of the body, even on abdominal tergite VIII. Well-developed wax glands have a distinct, here and

there, 1.5-2  $\mu$  thick border and, observed from above, have a honeycomb structure with a diameter of the hexagonal cells of 2-3  $\mu$ . With the disappearance of the wax glands, the few present are smaller, have no distinct border, and the honeycomb structure is not easily observable. Siphunculi (figs. 83, 84) colourless or very pale brown, the pore brown, cone-shaped; in the smallest specimens diameter of the pore about 50  $\mu$ , of the base 100  $\mu$ , and the cone 35  $\mu$  high; in large specimens pore diameter 60-75  $\mu$ , the base 150-250  $\mu$ , the cone 50-70  $\mu$  high and usually with somewhat swollen sides; on the cone 4-14 hairs. Cauda (fig. 85) transversely elongate, the knob e.g. 28  $\mu$  long, 65  $\mu$  wide, and at the constriction 40  $\mu$  wide; the knob of the cauda 40-81  $\mu$  wide; cauda with 6-9 hairs, the longest 40-56  $\mu$ . Subanal plate bilobed, with 10-22 hairs, the longest 44-70  $\mu$ . Subgenital plate with 4-5 anterior hairs, the longest 28-46  $\mu$ , and 4-11 posterior hairs, the longest 22-40  $\mu$ . Gonapophyses two, each with 3-8 hairs, 6-15  $\mu$  long, but in one specimen up to 28  $\mu$ .

Alate viviparous female.— In life: Head, mesothorax and metathorax dark brown, the margins of the thorax yellow, pronotum yellow with two green marks. Antennae black. Abdomen with a similar green pattern as in apterae. Cauda yellow. Legs dark grey, the distal part of the femur and tibia darker. Eyes black. Pterostigma grey. Last stage larvae have a green pattern as in apterae, but also with two green marks on the pronotum.

Macerated specimens.— (figs. 86-97; described from 28 specimens): Body length 1.63-2.10 mm. Head (fig. 86) across the eyes 360-417  $\mu$  wide, smooth, dark brown, dorsal to the horns with 11-18 hairs if the 3-8 hairs posterior to the paired ocelli are not included; length of the longest of these hairs 16-20  $\mu$ . Horns (fig. 87) 10-45  $\mu$  long, 20-25  $\mu$  wide at base, usually with round tips, and hairs which increase to the base in length; horns 0.02-0.11 times as long as the width of the head across the eyes. Antennae five-segmented, 700-960  $\mu$  long, 0.38-0.52 times as long as the body, and 1.8-2.4 times the width of the head across the eyes; segments I and II brown, paler than the head; segment I smooth with only some wrinkles; segment II (fig. 88) with 5-10 longitudinal ridges and transverse spinulose imbrications, more of such imbrications on the ventral side, the spinulae 1-3  $\mu$  long. Antennal segments III-V (fig. 89) with ring-shaped secondary rhinaria, the ring is not closed on the dorsal side over a length of 2-20  $\mu$ , between the rhinaria are 2-4 concentric ring-shaped spinulose imbrications with, especially on the dorsal side, interconnections. The rhinaria are about three  $\mu$  wide, the intervals 7-10  $\mu$ . The primary rhinaria are between the annular rhinaria and are moulded with them to a complex structure; segment III with 26-43, IV with 10-20, V with 8-18 annular rhinaria. Hairs usually on the dorsal side, acute, segment III with 2-6; IV, 2-3; V two, and five setae on the top of the processus terminalis; length of hairs on segment III, 9-14  $\mu$ . Length of segment III, 260-475  $\mu$ ; of IV, 130-187  $\mu$ ; of V, 147-182  $\mu$ , the tip of V distally to the rhinaria 12-26  $\mu$ . Antennal segment III is 1.7-2.8 times as long as IV, 1.5-2.9 times as long as V, and IV is 0.8-1.1 times as long as V. The last rostral segment is 0.63-0.78 times as long as the second tarsal segment of the hind leg; length of stylets 230-275  $\mu$ . Eyes compound, with the ocular tubercle extending sideways 15-20  $\mu$ .

Prothorax pale brown, two marginal hairs on each side, and usually four hairs anteriorly and four posteriorly. Mesonotum dark brown, the anterior margin with on each side a processus with broadly rounded tip and wide base, the longest hairs 16-27  $\mu$ . Fore wing (fig. 90) medial vein once branched, the hind wing with two oblique

veins. Legs brown, the distal part of the femora, and the basal part of the tibiae darker, almost smooth, but the second tarsal segments slightly imbricated; hairs acute longest hairs on tibia of hind leg 25-31  $\mu$ . First tarsal segments of fore leg (fig. 91) with three hairs, of mid- and hind leg with two; second tarsal segment of hind leg (fig. 92) dorsoapically with one hair longer than the other and expanded at the tip. Length of hind segments: femur, fused with trochanter, 409-456  $\mu$ , tibia 567-677  $\mu$ , first tarsal segment 27-31  $\mu$ , second tarsal segment 82-96  $\mu$ . The tibia of fore leg 1.0-1.2 times as long as the width of the head across the eyes, the hind tibia is 1.35-1.51 times as long as the hind femur plus trochanter.

Abdominal dorsum (fig. 93) without segmental borders, I-III colourless, IV and V sometimes with two small pale brown patches; VI with small pale brown marginal sclerites and the tergite with two pale brown patches, each with a dorsal hair; VII with pale brown indistinctly imbricated marginal sclerites and dorsally a transverse band with the two dorsal hairs; VIII has one solid brown patch, indistinctly imbricated, with 6-12 hairs and on the posterior margin, at about 1/3 of the width of the segment, a small processus (fig. 94) on each side; length of hairs dorsally on segment IV, 31-39  $\mu$ , ventrally 22-31  $\mu$ , on tergite VIII, 43-63  $\mu$ . Siphunculi (fig. 95) located on anterior part of abdominal segment V, pale brown, cone-shaped, about 40  $\mu$  high, with a diameter of the pore of 35-55  $\mu$ , the cone wide at the base 100-135  $\mu$ ; on the cone 8-15 hairs, the longest 33-53  $\mu$ . Cauda (fig. 96) colourless, the knob 25-35  $\mu$  long and 45-60  $\mu$  wide, with 5-11 hairs, the longest 35-47  $\mu$ . Subanal plate colourless, bilobed, with 13-23 hairs, the longest 35-59  $\mu$ . Subgenital plate (fig. 97) almost colourless with anteriorly in 18 out of 116 specimens four hairs, in the other specimens 5-7 hairs, the longest 27-43  $\mu$ ; posteriorly 6-13 hairs, 32-45  $\mu$  long. Gonapophyses two, each with 7-12 hairs, the longest 12-20  $\mu$ .

First stage larva of aptera (fig. 98, description of one specimen): Body length 700  $\mu$ , length of head plus pronotum 224  $\mu$ ; head across eyes 221  $\mu$  wide, anterior to the eyes dorsally four hairs in a transverse row, about 45  $\mu$  long, and usually 4-5 long hairs close to the base of each horn. Antennae four-segmented, 200  $\mu$  long, segment III, 67  $\mu$ ; IV, 80  $\mu$ ; length of hair on segment II, 33  $\mu$ ; on III, 43  $\mu$ . Horns pointed, 45  $\mu$  long and about 35  $\mu$  wide at the base. Tibia of fore leg 172  $\mu$  long, length of distal hair 50  $\mu$ ; distal hairs of hind tibia 50  $\mu$  long. All first tarsal segments with two hairs, 50-55  $\mu$  long. Second tarsal segment of fore leg with one dorsoapical hair with expanded tip, of mid- and hind leg with two. Wax gland groups usually lacking on meso- and metathorax, frequently also on other segments of the body except abdominal segments VII and VIII; distance between the wax gland groups of segment VIII in the middle 30-40  $\mu$ ; specimens with wax gland groups on all segments are very rarely collected. Abdominal tergites I-IV with four hairs, V with 2-4, VI, VII, VIII with two. Siphunculi are lacking.

The embryos in the apterae of 34 collections, just as the first stage larvae, have horns, wax glands and acute hairs just as the adult specimens belonging to each of these collections. In five of the 34 collections alatae are present and their embryos (fig. 99) are quite different: horns and wax glands are lacking, on the head anterior to the eyes are about 12 short curved setae, about five  $\mu$  long and two straight, capitate, hairs, 12  $\mu$  long, between the eyes four straight, capitate, hairs, about 15-18  $\mu$  long, and on dorsum of mesothorax, metathorax and abdominal segments I-V on each segment four capitate hairs, about 10-12  $\mu$  long.

Host plant records.— Specimens were collected in Java from the following plants, in the places and on the dates indicated, while the collectors are indicated by numbers between parentheses: Van der Goot or Van der Goot (1917) (1), in the collection at the Laboratorium voor Entomologie, Wageningen, or lost; F.W. Rappard (2), and P. Büchner (3), in the collection at the British Museum (Natural History), London; and D. Noordam (4), in the collection at the Rijksmuseum van Natuurlijke Historie, Leiden. Bamboo, Kepoeh, early I-1913 (on label 1912, *Cerataphis pallidus*) (1); bamboo, Warak (550 m), Sembir (400 m), Bogor (260 m), Mt. Merbaboe (1400 m), X-1913 till 1915, all *Oregma salatigensis* (1); bamboo, Bogor, 20.vii.1918, on label *O. salatigensis* (1); bamboo, Warak, 20.ix.1919, on label *O. salatigensis* (1); bamboo, Bogor, 8.ii.1920 (1); bamboo, Bogor, 8.ii.1920 (1), on label *Oregma pseudosalatigensis*; bamboo, Bondowoso (275 m), 25.viii.1949 (2); bamboo, Mt. Rayap (550 m), 5.xi.1950 (2); *Gigantochloa ? apus* (Bl. ex Schult.f.) Kurz, Banjoewangi, 8.vi.1948 (2); bamboo, Gloendengan (25 m), 13.xi.1950 (2); bamboo, 1.vi.30.vii.1956, B 4, 9 (3); bamboo, Bogor, Kebun Raya, 30.iii.1975 (4); *Bambusa arundinacea* (Retz.) Willd., 1.iv.1975 (4); bamboo, Bogor, 5.iv.1975 (4); bamboo, Bogor, Kebun Raya, 12.iv.1975 (4); bamboo, Bogor, 13.iv.1975, 18.iv.1975, (4); bamboo, 1.v.1975, (4); bamboo, 7.v.1975, (4); *Dendrocalamus asper* (Schult.f.) Backer ex Heyne, 8.v.1975, (4); bamboo, Sindanglaya (1100 m), 15.v.1975, (4); bamboo, Bogor Kebun Raya, 8.vi.1975, (4); bamboo, Sindanglaya, 28.vii.1975, 21.x.1975, 6.ix.1976, (4); bamboo, Bogor, Kebun Raya, 9.ix.1976, 23.xii.1976, 25.xii.1976, (4); bamboo, Sindanglaya (1100 m), 24.i.1977, (4); bamboo, Cisarua (800 m), 30.iv.1975; bamboo, Sindanglaya (1100 m), 29.x.1977, (4); bamboo, Bogor, Kebun Raya, 30.x.1977 (4); bamboo, Sindanglaya (1100 m), 1.xi.1977, (4); bamboo, Bogor, Kebun Raya, 20.xi.1977 (4); bamboo, Sindanglaya (1100 m), 28.xi.1977, (4); *Bambusa blumeana* Bl. ex Schult.f., Lawang (500 m), 25.xii.1977, 27.xii.1977, 29.xii.1977, (4); bamboo, Cimahi-Bandung, 2.i.1978 (4); bamboo, Bandung, 2.i.1978, (4); bamboo, Cipanas-Garut (800 m), 6.ii.1978, (4).

The aphids live on the lower side of leaves, at altitudes of 0-1400 m. Early in January and March single specimens were observed on the lower side of the leaf blade. These specimens usually remain unnoticed, but large populations are spread all over the lower sides of the leaves of many stems of the bamboo, and the upper sides of leaves are black due to sooty moulds; in these large populations the specimens are not usually very crowded but a free space is present between them of 1-5 or more mm. At the end of December to early February, apterae were collected which, compared with apterae in collections with alatae, had short antennae, and short tibiae of the fore leg, and which produced a lot of wax at the margins of the body and on the dorsum. I venture to assume that these specimens belonged to populations which had recently started to develop; the fore tibiae of these specimens were 0.71 to 0.79 times as long as the width of the head across the eyes. The fore leg tibiae of apterae in the five collections with alatae were 0.91 to 1.1 times as long as the width of the head across eyes; all apterae of these five collections were large, 1.7-2.2 mm; if wax glands were present they were, at the most, on five segments of the body. Most collections were made at altitudes of 0-500 m, but all five collections with alatae were from altitudes of 800-1100 m.

Etymology.— Van der Goot (1917) gave the name *pallida*: pale, undeniable in reference to the fewer green marks on the body than is the case with *A. salatigensis*. *Salatigensis* refers to the town of Salatiga.

***Astegopteryx pandani* (Takahashi, 1935)**  
(figs. 100-102)

*Trichoregma pandani* Takahashi, 1935: 8.

*Astegopteryx pandani*; Eastop & Hille Ris Lambers, 1976: 97.

Types.— Aptera vivipara type specimens are in the collection of the Department of Agriculture Research Institute, Taiwan (Takahashi, 1935).

Takahashi (1935) described *Trichoregma pandani* which was collected at Medan (Sumatra) by Mr J.C. van der Meer Mohr from *Pandanus tectorius* Soland ex Park in October 1934. The description of the species agrees fairly well with the aphids I collected from *Freycinetia javanica* Bl., and so I assume that the *Freycinetia* species is *A. pandani*.

Apterous viviparous female.— In life: As described of *A. muiri*, but the wax fringe more striking, and larvae are brown on the sides of the abdomen.

Macerated specimens.— (figs. 100-102; described from one specimen, and some characters from nine bleached specimens and two larvae). Body length 1.37 mm. Head across the eyes 285-310  $\mu$ , very pale brown, smooth. Horns with somewhat lumpy sides, but with a long, smooth, sharp point, hairs 6-14  $\mu$  long; length of horns 37-47  $\mu$ , 1.5-2 times as long as the width at the base, 0.13 times as long as the width of the head across eyes. Wax glands about in a straight line medial to the eyes and together with the eyes somewhat on a tubercle, on each side with 5-8 glands; largest diameter of the glands 47  $\mu$ ; separate oval wax glands on the median area of head, thorax and abdomen not observable. Length of longest hairs dorsally on the head 51  $\mu$ . Antennae with four segments, very pale brown, the last segment slightly darker, 250-285  $\mu$  long, 0.20-0.21 times as long as the body, 0.8-0.9 times the width of the head across the eyes. Antennal segment III, 0.37-0.41 times as long as the width of the head across the eyes. Length of antennal segments: III, 105-127  $\mu$ ; IV, 79-88  $\mu$ ; the processus terminalis about 20  $\mu$  long. Last antennal segment distally with smooth imbrications, and spinulae around the rhinarium, antennal segment III distally on the ventral side with some imbrications with 2-5 spinulae; antennal segment II with about eight longitudinal ridges; longest hair of antennal segment III, 35  $\mu$ . Eyes somewhat brown, with three ommatidia. Ultimate rostral segment 60  $\mu$  long, 0.77 times as long as the second tarsal segment of the hind leg; stylets 286-322  $\mu$  long.

Prothorax fused with the head, marginally with 3-6 wax glands. Mesothorax marginally very pale brown, with 3-7 wax glands, the dorsum colourless with six hairs. Metathorax colourless with 3-6 marginal wax glands, the dorsum with seven hairs. Legs evenly very pale brown, the tarsi not darker, smooth, even the tarsi; tibia of fore leg 0.70 times as long as the width of the head across the eyes; longest hair on basal half of tibia of hind leg 43-45  $\mu$ ; the second tarsal segment of hind leg 78  $\mu$  long, 0.23 times as long as the tibia of hind leg, and 0.25 times the width of the head across the eyes. First tarsal segment of fore leg with three hairs, mid- and hind leg with two; second tarsal segment of hind leg with two dorsoapical hairs, presumably both widened at the tip, three  $\mu$  wide; empodial hair four  $\mu$  long. Length of segments of hind leg: femur plus trochanter 291  $\mu$ , tibia 334  $\mu$ , first tarsal segment 27  $\mu$ .

Abdomen colourless smooth with some spinulose imbrications, most clearly on segments VII and VIII. Ventral-marginally linear s-shaped wax glands distinctly pre-

sent, observable at magnifications of 200 or more. Number of hairs on abdominal tergites: I eight, II seven, III six, IV eight, V seven, VI four, VII two, VIII seven. Length of hairs on abdominal tergite IV, 55  $\mu$ ; ventrally on segment IV, 22  $\mu$ ; spinally on tergite VIII, 51  $\mu$ . Marginal wax glands in a straight longitudinal line, with an interval between the segments, but in each group the glands are squeezed flat against each other; number of wax glands on the segments: I, 2-5; II, 3-5; III, 3-5; IV, 4-5; V, 3-5; VI, 3-6; VII, 3-5; VIII two groups of 5-8, with an interval of 0-3  $\mu$  between the two groups. The border of the wax glands is a yellow line, about 1.5  $\mu$  wide, with 4-6 corners, and a diameter of 2.5-4  $\mu$ , all as distinct as in *A. nipae*. Largest diameter of wax glands on segment VIII, 58  $\mu$ ; on segment III and IV, 64-69  $\mu$ . Siphunculi colourless, the pore brown, cone-shaped, 25  $\mu$  high, 135  $\mu$  wide at the base, diameter of the pore 48  $\mu$ , with 6-11 hairs on the cone. Cauda transversely elongate, 25  $\mu$  long, 67  $\mu$  wide and diameter of the constriction 55  $\mu$ , with 13-15 hairs, the longest 53  $\mu$ . Subanal plate bilobed, with 17 hairs, the longest 53  $\mu$ . Subgenital plate with four anterior hairs, the longest 29  $\mu$ , and posteriorly 12 hairs, the longest 31  $\mu$ . Gonapophyses not visible.

Host plant record.— *Freycinetia javanica* Bl. on Mt. Salak (Bogor) at 700 m, 25.v.1975, leg. D. Noordam, in the collection at the Rijksmuseum van Natuurlijke Historie, Leiden.

The aphids were living on the lower side of the leaf, with ants.

Etymology.— *Pandani*, from *Pandanus*, the plant from which the aphids were collected for the first time.

Discussion.— *Freycinetia* and *Pandanus* belong to the family Pandanaceae, and so maybe *A. pandani* is restricted to this family. *A. pandani* has more characters in common with *A. muiri* than with *A. nipae*, see key; the distinct facets and the border of the wax glands, the diameter of the pore of the siphunculi, and the relative length of the second tarsus of the hind leg seem more like *A. nipae*.

### *Astegopteryx rappardi* Hille Ris Lambers, 1953 (figs. 103-111)

*Astegopteryx rappardi* Hille Ris Lambers, 1953: 94.

Types.— Cotypes: apterous viviparous females, alate viviparous females and larvae, *Cocos nucifera*, Java, Banjoewangi, 19.iii.1949, leg. F.W. Rappard, no. 116 are in the collection at the British Museum (Natural History), London.

Hille Ris Lambers (1953: 94) gives a short record on this species, mentioning five characters by which apterae can be distinguished from those of *A. nipae* (Van der Goot, 1917), and two characters in which the alatae of these species are different.

Apterous viviparous female.— In life (pl. 13): Pale brown head, antennae, legs, anterior part of thorax, and end of the abdomen; abdomen brown or due to the presence of wax, brownish red or dark violet. Because of the wide variety of colours occurring in *A. nipae*, the species cannot be separated on grounds of colours. But the body of *A. rappardi* is more oblong than that of *A. nipae* and the marginal wax gland groups of abdominal segments I-IV are located somewhat closer to the middle, about up to a longitudinal line anterior to the centre of the siphunculi; in *A. nipae* such a line would be drawn along the outer margin of the base of the siphunculi. The length



of the wax fringe in both species varies greatly. The dorsum is sometimes smooth, showing a few segmental transverse patches, or is covered with some white wax powder.

Macerated specimens.— (figs. 103-105; described from 10 specimens): Body length 1.24-1.51 mm. Head across the eyes 310-377  $\mu$  wide, brown, the frontal part darker, smooth. Horns (figs. 104, 105) with somewhat lumpy sides, but with a smooth, sharp point, with hairs, 8-10  $\mu$  long; length of the horns 50-98  $\mu$ , 0.16-0.26 times as long as the width of the head across the eyes; length of the point of the horn, distally to the ultimate hair 5-14  $\mu$ . Wax glands arranged in an oval group medial to the eyes, with 5-8 glands; diameter of the largest gland 25-50  $\mu$ . On the median area of the head, and even more distinct on the median area of thorax and abdominal segments I-VI, oval separate wax glands with an irregular outline and lacking the distinct facet structure of the marginal wax glands. Length of longest hairs dorsally on the head 32-53  $\mu$ . Antennae with four or five segments, brown, the last segment darker, 260-318  $\mu$  long, 0.19-0.28 times as long as the body, 0.8-0.9 times the width of the head across the eyes. Antennal segment III in four-segmented antennae, or III + IV in five-segmented antennae, 0.32-0.52 times as long as the width of the head across the eyes. Length of antennal segments in four-segmented antennae: III, 101-143  $\mu$ ; IV, 78-98  $\mu$ ; in five-segmented antennae: III, 78-129  $\mu$ ; IV, 53-67  $\mu$ , and V, 91-110  $\mu$ ; the processus terminalis about 25  $\mu$  long. Last antennal segment distally with smooth imbrications, and spinulae around the rhinarium, otherwise segments III-V smooth, or with a few spinulae ventrally; antennal segment II with about 10 longitudinal ridges. Eyes about as dark as the front of the head, with three ommatidia. Ultimate rostral segment 48-58  $\mu$  long, 0.60-0.73 times as long as the second tarsal segment of the hind leg; stylets 205-247  $\mu$  long.

Prothorax fused with the head, marginally with 4-6 wax glands. Mesothorax margins pale brown, the dorsum with two brown patches or one transverse band, at each margin 2-5 wax glands, dorsally about six hairs, metathorax as mesothorax but the margins almost colourless. Legs evenly brown, about as dark as the head, smooth, even the tarsi; tibia of fore leg 0.66-0.71 times as long as the width of the head across the eyes; first tarsal segment of fore leg with three hairs, of mid- and hind leg with two; the second tarsal segment of the hind leg 73-88  $\mu$  long, 0.21-0.23 times as long as the tibia of the hind leg, and 0.22-0.25 times as long as the width of the head across the eyes; with two dorsoapical hairs expanded at the tips, distally up to 3.5 wide; empodial hairs of hind leg 23-26  $\mu$  long. Length of segments of hind leg: femur plus trochanter 275-306  $\mu$ , tibia 340-382  $\mu$ , first tarsal segment 34-36  $\mu$ .

Abdominal margins colourless but the dorsum on each segment with a brown transverse band, on the anterior segments incised or even interrupted in the middle; the pleurae anterior and posterior to the siphunculi colourless, and a transverse zone between the bands colourless; tergite VIII wholly brown; anterior to the lateral sides of the bands intermuscular sclerites are usually visible. Linear s-shaped wax glands ventral-marginally absent. Abdominal tergites VI-VIII with some spinulose imbrications. Number of hairs on abdominal tergites: I, 6-11; II, 3-8; III, 3-8; IV, 4-7; V, 4-6; VI, 2-5; VII, 2-4; VIII, 4-6. Length of hairs on abdominal tergite IV, 36-74  $\mu$ ; ventrally on segment IV, 14-16  $\mu$ ; on tergite VIII spinal hairs 58-68  $\mu$ . Wax glands pale brown on segments I-VII marginally on colourless sclerites; if compared with *A. nipae* the gland groups of segments I-IV and VI are moved to the medial side, the medial border of

the glands of segments IV and VI are about in line with the middle of the siphunculi; the distance between the medial borders of the wax glands on both sides of segment III is 0.27-0.32 times the length of the body. In each group of segments I-VI, one or more glands are strongly wedge-shaped and are arranged in a curved line or irregularly, squeezed flat against each other; number of wax glands on the segments: I, 3-4; II, 3-5; III, 3-5; IV, 4-5; V, 4-5; VI, 2-5; VII, 3-5; and on VIII two groups of 3-5 with an interval in the middle of 0-25  $\mu$ , usually 0-10  $\mu$ . The border of the glands is seen as a yellow line, about 1.5  $\mu$  wide, the gland has facets with 4-6 corners, with a diameter of 2-3  $\mu$ . Largest diameter of wax glands on segment VIII about 48-55  $\mu$ , on segment III, 49-72. Siphunculi brown, darker than the bands on the tergites, cone-shaped, 30-45  $\mu$  high, 100-135  $\mu$  wide at the base, diameter of the pore 30-40  $\mu$ , with 4-9 hairs on the cone. Cauda transversely elongate e.g. 25  $\mu$  long, 61  $\mu$  wide and diameter of the constriction 47  $\mu$ ; knob of the cauda 63-73  $\mu$  wide, with 8-13 hairs, the longest 49-57  $\mu$ . Subanal plate bilobed, with 21-26 hairs, the longest 59-69  $\mu$ . Subgenital plate with four anterior hairs, the longest 18-23  $\mu$ , and 3-8 posterior hairs, the longest 15-22  $\mu$ . Gonapophyses two, each with 2-5 hairs, the longest 6-8  $\mu$ .

Alate viviparous female.— In life: Pure black, dull (F.W. Rappard).

Macerated specimens.— (figs. 106-109; described from five specimens). Body length 1.07-1.52 mm. Head across eyes 316-395  $\mu$  wide, smooth, dark brown, dorsally to the horns with about 9-13 hairs, 18-30  $\mu$  long. Horns 6-28  $\mu$  long, with a round tip; horns 0.02-0.08 times as long as the width of the head across the eyes. Antennae with five segments, 520-590  $\mu$  long, 0.37-0.49 times as long as the body, and 1.4-1.6 times the width of the head across the eyes; segment I brown, smooth, segment II brown, with some longitudinal ridges, and ventrally with some spinulose imbrications, the spinulae 1-2  $\mu$  long. Antennal segments III-V (fig. 107) with ring-shaped secondary rhinaria, the ring is not closed on the dorsal side; between the rhinaria are 2-3 concentric ring-shaped spinulose imbrications, on the dorsal side with interconnections; The rhinaria are 2-4  $\mu$  wide, the intervals 4-10  $\mu$ . The primary rhinaria are between the annular rhinaria and are moulded with them to a complex structure; segment III with 26-31, IV with 9-13, V with 11-15 annular rhinaria; segment V with five apical setae. Length of segment III, 235-280  $\mu$ ; of IV, 95-105  $\mu$ ; of V, 125-140  $\mu$ ; the tip of V distally to the ultimate rhinarium 18-22  $\mu$ . Antennal segment III is 2.3-2.8 times as long as IV, 1.9-2.0 times as long as V, and 1.0-1.2 times as long as IV plus V; segment IV is 0.7-0.8 times as long as V. Length of the last rostral segment 48-59  $\mu$  long, 0.66-0.79 times as long as the second tarsal segment of the hind leg; length of the stylets 214-245  $\mu$ . Eyes compound, the ocular tubercle extending sideways about 20  $\mu$ .

Mesothorax dark brown. Fore wing (fig. 108) medial vein once branched, the hind wing with two oblique veins. Length of the pterostigma from the base of the radial sector to the anterior margin of the fore wing 0.7-0.8 times the distance from the end of the pterostigma to the end of the radial sector. Legs brown, almost smooth, but the second tarsal segments with some spinulose imbrications. Longest hairs on tibia of the hind leg 18-22  $\mu$ . First tarsal segments of the fore leg with three hairs, of the midleg with 2-3, of the hind leg with two; second tarsal segment of the hind leg dorsoapically with two hairs expanded at the tips, 40-49  $\mu$  long, the tips 4-5  $\mu$  wide; empodial hairs 25-27  $\mu$  long. Length of the hind segments; femur fused with trochanter, 356-375  $\mu$ , tibia 454-492  $\mu$ , first tarsal segment 27-33  $\mu$ , second tarsal seg-

ment 73-76  $\mu$ . The tibia of the fore leg is 0.9-1.0 times as long as the width of the head across the eyes, the hind tibia is 1.27-1.31 times as long as the hind femur plus trochanter; the second tarsal segment of the hind leg is 0.19-0.22 times as long as the width of the head across the eyes.

Abdomen.— (fig. 109). Abdominal segments I-VI presumably colourless; VII marginally with a pale brown patch, dorsally presumably colourless, with some spinulose imbrications; tergite VIII pale brown, with some fairly indistinct spinulose imbrications. Number of hairs on tergite III, 7-8; IV, 5-6; V, 4-5; VI two, VII two, VIII four; length of hairs dorsally on segment IV, 40-45  $\mu$ , ventrally, 15-18  $\mu$ , on tergite VIII, 42-47  $\mu$ . Siphunculi located on segment V, pale brown, cone-shaped, about 25  $\mu$  high, with a diameter of the pore of 33-38  $\mu$ , the cone at the base 100-120  $\mu$  wide; on the cone 4-6 hairs, the longest 27-35  $\mu$ . Cauda colourless, transversely elongate, e.g. the knob 54  $\mu$  wide, 22  $\mu$  long, diameter of the constriction 47  $\mu$ ; cauda knob 50-80  $\mu$  wide, with 9-12 hairs, the longest 42-47  $\mu$ . Subanal plate bilobed, with 18-22 hairs, the longest 43-51  $\mu$ . Subgenital plate with anteriorly 4-5 hairs, the longest 25-37  $\mu$ , and 7-10 posterior hairs, the longest 30-36  $\mu$ . Gonapophyses two, each with seven hairs, the longest 10  $\mu$ .

First stage larva of apterae (figs. 110, 111; description of one specimen): Body length 641  $\mu$ , length of head plus pronotum 204  $\mu$ , head across eyes 216  $\mu$ . Antennae with four segments, 191  $\mu$  long, length of hair on segment II, 30  $\mu$ , on III, 35  $\mu$ . Horns pointed, 48  $\mu$  long, and 43  $\mu$  wide at the base. Longest hair dorsally on the head 48  $\mu$ . Tibia of the fore leg 151  $\mu$  long, distal hairs of the tibiae 38-40  $\mu$ , that of the hind leg more sturdy. All first tarsal segments with two hairs, 40-45  $\mu$  long. Second tarsal segments of the fore leg dorsoapically with one larger hair expanded at the tip; empodial hairs 20-25  $\mu$  long. Wax glands on all segments of the body, on the head in an oval group, on abdominal segments VII and VIII in a straight line, but on the other segments in a slightly curved line, and some of the glands more or less wedge-shaped, with intervals between the segments. Dorsally to the wax glands on abdominal segments I-VII one marginal hair, on tergites I-IV four hairs, on V three, and on VI-VIII two; length of hairs on tergites I-VII, 28-35  $\mu$ , on VIII, 43  $\mu$ . Siphunculi are lacking.

Embryos in alatae are similar to those of apterae, but in one collection (of 11.ii.1949) embryos inside the alata have blunt hairs on the head, and marginally and dorsally on the body, while horns and wax glands are lacking.

Host plant records.— The aphid specimens collected from Java are all from *Cocos nucifera* L., the collectors are indicated by numbers between parentheses: P. van der Goot (1), in the collection at the Laboratorium voor Entomologie, Wageningen; F.W. Rappard (2), in the collection at the British Museum, London; D. Noordam (3), in the collection at the Rijksmuseum van Natuurlijke Historie, Leiden: 18.iii.1916, Bodjonegoro (1); 3.viii.1916, Tjipanas (1); 11.ii.1949, and 19.iii.1949, both Banjoewangi (2); 17.xii.1976, Bogor (3); 5.ii.1978, Cipanas-Garut (3). On the lower side of leaves, on old yellowing leaves, but the aphids also cause yellowing of the leaflets.

Alatae were collected on 18.iii.1916, 3.viii.1916, 11.ii.1949, and 19.iii.1949.

Etymology.— Rappardi, name given by Hille Ris Lambers (1953) to commemorate Dr F.W. Rappard, of the Forestry Service of Indonesia, who undertook the collection of Hormaphidinae from Java.

***Astegopteryx rhapsidis* (Van der Goot, 1917)**  
(figs. 112-122)

*Oregma rhapsidis* Van der Goot, 1917: 217.

*Astegopteryx rhapsidis*; Eastop & Hille Ris Lambers, 1976: 97.

Types.— Neotype (apterous viviparous female, here designated) from *Cocos* leaf, Bogor, 6.viii. 1918, collected P. v.d. Goot, no. 139, det. by P. v.d. Goot: *Oregma rhapsidis*. Among nine slides with about 50 apterae, in the collection at the Laboratorium voor Entomologie, Wageningen.

Van der Goot (1917) described this species on the basis of specimens from one gathering, which contained apterae and alatae: Presumably the material is lost, but the colour in life, the size of the pore of the siphunculi, the arrangement of the wax glands, especially the large distance between the two groups on abdominal segment VIII, and the fact that they live on palm leaves are sufficient characteristics to be certain that the species described here, is *A. rhapsidis*. This view is supported by a gathering of Van der Goot of 6.viii.1918, which he identified as *Oregma rhapsidis*. The variation of several characters is still great and apart from the characters mentioned by Van der Goot, other are needed to identify the species with certainty, see key on apterae and alatae.

Apterous viviparous female.— In life (pls 14, 15): Head, antennal segments I, II and base of III, legs and cauda yellow. Other part of antennal segment III and distal segments grey or brownish yellow, the ends of the antennae darker. Specimens from younger populations thorax and abdomen pale brown or brownish yellow, sometimes with a slight reddish marbling, from older populations with alatae the colour more brown, even with brown transversal bands on the thorax and brown marbling or longitudinal bands on the abdomen; the siphunculi brown with the area anterior and medial to the siphunculi yellow; the abdomen ventrally also with brown longitudinal streaks. Cauda yellow. Eyes black. Specimens of younger populations with a wax fringe which is the longest on abdominal segment VIII, and small on head and thorax, with an interval between the segments, and in the middle of segment VIII and there sometimes a wider space than in *A. nipae*; antennae, legs and the whole dorsal side is covered with a fairly smooth whitish wax which changes the colours somewhat. The specimens, adults and larvae in old populations look as though they are covered with snow, sometimes thick flocks on the dorsum, on the margins, on the antennae and legs, and a layer of flakes on the leaf, indicating that the specimens also walk over each other.

Macerated specimens.— (figs. 112, 113; described from 17 specimens): Body length 1.23-1.95 mm.

Head.— Head pale brown or brown, dorsally smooth with some wrinkles anterior and medial to the eyes, with a median suture or colourless line even faintly visible at the posterior margin of the pronotum; frons protruding in the middle 0-10  $\mu$ ; head across the eyes 298-395  $\mu$  wide. Horns with somewhat lumpy sides, but with a smooth, sharp point, with hairs, 4-10  $\mu$  long; length of the horns 50-80  $\mu$ , of the point, distally to the ultimate hair about 10-18  $\mu$ . Wax glands medial to the eyes, located on a slightly raised tubercle together with the eyes, number 0-6, arranged singly, in a curved line or oval group, 3-17  $\mu$  diameter. Oval separate wax glands on the median

area of anterior segments (as in *A. rappardi*, and *A. nipae*) usually not observable. Length of longest hairs dorsally on the head 34-53  $\mu$ . Antennae with four or five segments, pale brown or brown, towards the end slightly darker, 250-560  $\mu$  long, 0.19-0.31 times as long as the body, 0.8-1.4 times the width of the head across the eyes. Antennal segment III in four-segmented antennae, or III plus IV in five-segmented antennae, 0.35-0.66 times as long as the width of the head across the eyes. Length of antennal segments in four-segmented antennae: III, 105-160  $\mu$ ; IV, 78-104  $\mu$ ; in five-segmented antennae: III, 90-220  $\mu$ ; IV, 55-110  $\mu$ ; and V, 80-136  $\mu$ ; the processus terminalis 12-30  $\mu$  long. Last antennal segment distally with smooth imbrications, and spinulae around the rhinarium, otherwise segments III-V dorsally smooth, ventrally with spinulose imbrications, but III only distally and few; antennal segment I with some longitudinal ridges, II with about 10. Eyes about as dark as the front of the head, with three ommatidia. Ultimate rostral segment 48-60  $\mu$  long, 0.52-0.70 times as long as the second tarsal segment of the hind leg; stylets 210-260  $\mu$  long.

Thorax.— Prothorax fused with the head, with 0-5 marginal wax glands. Mesothorax margins and dorsum colourless, pale brown or brown, the dorsum usually with two transverse patches, at each margin 0-4 wax glands, angular or circular, largest diameter of glands 5-20  $\mu$ , the dorsum with about 8-12 hairs. Metathorax margins colourless, the dorsum sometimes with two pale brown or brown patches, at each margin 0-4 wax glands, dorsally about 8-12 hairs. Legs evenly pale brown, or brown, and then the basal part of mid- and hind femora paler, smooth, even the tarsi; tibia of fore leg 0.59-0.87 times as long as the width of the head across the eyes. First tarsal segment of the fore leg with 3-4 hairs, the middle hairs more sturdy, of midleg with two or sometimes three hairs, of hind leg with two. Second tarsal segment of the hind leg 0.20-0.26 times as long as the tibia of the hind leg, and 0.23-0.31 times as long as the width of the head across the eyes, two dorsoapical hairs usually both of the same length, the tip blunt or slightly expanded, 43-55  $\mu$  long and 1-2  $\mu$  wide at the tip. Empodial hairs of the hind leg 0-6  $\mu$  long. Length of segments of the hind leg: femur plus trochanter 259-423  $\mu$ , tibia 287-495  $\mu$ , first tarsal segment 28-36  $\mu$ , second tarsal segment 75-107  $\mu$ .

Abdomen.— Abdomen almost colourless, but in one gathering the dorsum of segment I with two brown patches, and one hair of segment II on a brown sclerite. Ventral-marginally distinct linear s-shaped wax glands, abdominal tergites VI-VIII with some spinulose imbrications; number of hairs on the tergites: I, 9-16; II, 8-17; III, 9-19; IV, 11-24; V, 8-20; VI, 2-7; VII two, VIII, 4-7. Length of hairs on tergite IV, 52-80  $\mu$ , ventrally on segment IV, 16-30  $\mu$ , and short hairs 10-14  $\mu$ , on tergite VIII spinal hairs 52-64  $\mu$ . Wax glands in specimens of young populations colourless or very pale brown on colourless sclerites, arranged in a straight longitudinal line, with an interval between the segments, the glands in each group squeezed flat against each other; number of wax glands on the segments: I, 2-4; II, 2-5; III, 2-5; IV, 2-4; V, 2-4; VI, 2-5; VII, 4-5; VIII two groups of 5-7 with an interval in the middle of 20-50  $\mu$ , exceptionally less; largest diameter of wax glands on segments III and VIII, 25-45  $\mu$ ; in older populations more and more wax glands are lacking, and wax glands may be present only on segments VII and VIII, the interval between the two groups of segment VIII is usually 50-100  $\mu$ , largest diameter of glands 20-45  $\mu$ . The border of wax glands is seen as a yellow line, 1-2  $\mu$  wide, the gland has facets with 4-6 corners, and a diameter of about 3  $\mu$ . Siphunculi pale brown or brown, cone-shaped, 40-50  $\mu$  high, 110-200

$\mu$  wide at the base, diameter of the pore 45-90  $\mu$ , with 7-20 hairs on the cone. Cauda transversely elongate, e.g. 37  $\mu$  long, 96  $\mu$  wide and diameter of the constriction 69  $\mu$ ; knob of the cauda 50-96  $\mu$  wide, with 8-13 hairs, the longest 43-55  $\mu$ . Subanal plate bilobed, with 14-19 hairs, the longest 41-55  $\mu$ . Subgenital plate with four anterior hairs, the longest 20-35  $\mu$ , and 2-10 posterior hairs, the longest 18-33  $\mu$ . Gonapophyses two, each with 3-8 hairs, the longest 8-15  $\mu$ .

Alate viviparous female.— In life: Head dull black, thorax shiny black. Antennae black. Legs greyish green or greyish black. Abdomen dirty yellow or blackish brown or blackish green. Cauda yellow. Eyes black. Pterostigma dark green.

Macerated specimens— (figs. 114-119; described from 13 specimens): Body length 1.43-1.97 mm.

Head.— (fig. 114). Head smooth, brown, in the median line some colourless longitudinal patches, width across the eyes 345-450  $\mu$ , dorsally to the horns and anterior to the paired ocelli with about 8-12 hairs, the longest dorsal hairs 16-18  $\mu$ . Horns pointed or with rounded tips, 0-20  $\mu$  long, 0.00-0.05 times as long as the width of the head across the eyes. Antennae five-segmented, 635-990  $\mu$  long, 0.35-0.57 times as long as the body, and 1.5-2.5 times the width of the head across the eyes; segment I brown, paler than the head, somewhat wrinkled; segment II brown, with some longitudinal ridges, dorsally and ventrally with spinulose imbrications, the spinulae 1-2  $\mu$  long; segments III-V (fig. 115) with ring-shaped secondary rhinaria, the rings are not closed on the dorsal side with an interval of 2-20  $\mu$ , but several rings on segments IV and V look closed; between the rhinaria are 2-4 concentric ring-shaped spinulose imbrications, on the dorsal side with interconnections. The rhinaria are 3-4  $\mu$  wide, the intervals 6-10  $\mu$ . The primary rhinaria are between the annular rhinaria, and are moulded with these to a complex structure; segment III with 26-42, IV with 10-18, V with 5-15 annular rhinaria; hairs are usually on the dorsal side, acute, segment III with 1-3, IV with 2-4, V with two and five setae on the top of the processus terminalis; length of hairs on segment III, 9-10  $\mu$ . Length of segment III, 312-470  $\mu$ ; IV, 110-215  $\mu$ ; V, 125-205  $\mu$ ; the tip of V distally to the ultimate rhinarium 20-22  $\mu$ ; segment III is 2.1-3.1 times as long as IV, 2.3-3.0 times as long as V, and 1.1-1.5 times as long as IV plus V; segment IV is 0.9-1.2 times as long as V. The last rostral segment is 0.52-0.66 times as long as the second tarsal segment of the hind leg; length of stylets 250-265  $\mu$ . Eyes compound, with the ocular tubercle extending sideways 6-14  $\mu$ .

Thorax.— Prothorax pale brown, mesonotum dark brown. Fore wing (fig. 116) medial vein once branched, the hind wing with two oblique veins. Legs brown, the basal part of the femora paler, distal end of femora and base of tibiae darker on the dorsal side, smooth, the tarsi with some almost smooth imbrications; hairs acute, the longest on the tibia of the hind leg 41-49  $\mu$ . First tarsal segments of fore leg with 3-4 hairs, of midleg with two and exceptionally with three, of hind leg with two; second tarsal segment of hind leg dorsoapically with one hair expanded at the tip, length of the hair 49-57  $\mu$ , at the tip about two  $\mu$  wide; the second dorsoapical hair acute, half the length of the other; length of the empodial hair 31-34  $\mu$ . Length of hind segments in four specimens: femur fused with trochanter, 435-441  $\mu$ , tibia 535-559  $\mu$ , first tarsal segment 37-39  $\mu$ , second tarsal segment 97-103  $\mu$ . The tibia of the fore leg is 0.7-1.1 times as long as the width of the head across the eyes, the hind tibia is 1.21-1.27 times as long as the hind femur plus trochanter; the second tarsal segment of the hind leg is 0.20-0.26 times as long as the width of the head across the eyes.

Abdomen.— (fig. 118). Abdominal segments I-V colourless, VI and VII sometimes with a pale brown marginal sclerite and on the dorsum a transverse pale brown patch, and VIII sometimes pale brown, all sclerotic parts with spinulose imbrications. Number of hairs on tergite V between the siphunculi 10-16, on VI, 2-5, VII, two; VIII, 3-6; length of hairs dorsally on segment IV, 23-29  $\mu$ , ventrally on IV about 20  $\mu$ , on tergite VIII, 33-43  $\mu$ . Siphunculi located on segment V, colourless or pale brown, cone-shaped, 15-25  $\mu$  high, diameter of the pore 30-43  $\mu$ , the cone at the base 100-125  $\mu$  wide; the cone with 14-18 hairs, the longest 25-33  $\mu$ . Cauda colourless, transversely elongate, e.g. 90  $\mu$  wide, 38  $\mu$  long, diameter of the constriction 57  $\mu$ ; cauda knob 68-90  $\mu$  wide, with 11-13 hairs, the longest 41-49  $\mu$ . Subanal plate bilobed, with 14-17 hairs, the longest 41-49  $\mu$ . Subgenital plate with anteriorly four, exceptionally three hairs, the longest 35-43  $\mu$ , posteriorly 5-10 hairs, the longest 33-41  $\mu$ . Gonapophyses two, each with 6-9 hairs, the longest 14-18  $\mu$ .

First stage larva of apterous viviparous female (fig. 120, description of one specimen). Body length 625  $\mu$ , length of head plus pronotum 204  $\mu$ , 0.84 times the width of the prothorax; width of the head across the eyes 224  $\mu$ . The head dorsally, and dorsally to the horns with 6-9 hairs; two rows each of four hairs between the eyes, 25-30  $\mu$  long; horns pointed, 55  $\mu$  long, and 45  $\mu$  wide at the base. Antennae four-segmented, 200  $\mu$  long, segment III, 76  $\mu$  long, with a hair 38  $\mu$  long, segment IV, 74  $\mu$  long, the processus terminalis 26  $\mu$ , with five apical setae, 14  $\mu$  long. The tibiae, first and second tarsal segments smooth; the tibia of the fore leg 160  $\mu$  long, 0.71 times as long as the width of the head across the eyes; length of distal hairs of the hind tibia 50  $\mu$ . All first tarsal segments with two hairs, of the hind tarsus 53  $\mu$  long. Second tarsal segments of the fore leg dorsoapically with one larger hair slightly expanded at the tip, mid- and hind leg with two, 61  $\mu$  long, the tip 1-2  $\mu$  wide; empodial hairs 27  $\mu$  long, with the expanded tip, one  $\mu$  wide. Wax glands on all segments of the body, arranged on each segment in a longitudinal straight line; segment VIII with two groups, each with 6-8 glands, with an interval in the middle of 6-16  $\mu$ . Abdominal tergites I-II with five hairs, III-V with six, VI-VIII with two; length of hair dorsally on IV, 37  $\mu$ , ventrally 18  $\mu$ , on tergite VIII, 29  $\mu$ . Siphunculi are lacking.

Embryos in alatae are similar to those of apterae, but in one alata one of the embryos (figs. 121, 122) has no horns or wax glands. The head anteriorly and ventrally with about six hairs, 20-27  $\mu$  long, 1-2  $\mu$  wide at the base, capitate or with expanded tip; next to these hairs are four or six spine-like hairs in the middle, 14-22  $\mu$  long and 3-5  $\mu$  wide, tapering but with blunt tip. The head, thorax and body dorsally with hairs with expanded tips, 25-45  $\mu$  long and 2-4  $\mu$  wide, with almost parallel sides.

Host plant records.— The aphid specimens collected from Java are all from palms, the names are mentioned below, while the collectors are indicated by numbers between parentheses: P. van der Goot (1917) or afterwards (1), in the collection at the Laboratorium voor Entomologie, Wageningen or lost; F.W. Rappard (2), in the collection at the British Museum (Natural History), London; D. Noordam (3), in the collection at the Rijksmuseum van Natuurlijke Historie, Leiden: *Rhapis javanica*, Salatiga, IV-1915 (1); *Cocos nucifera* L., ? *Livistona altissima* (1); *Cocos nucifera* L., Bogor, 6.viii.1918 (1); *Cocos nucifera*, Banjoewangi, 9.viii.1948, 23.viii.1948, 5.ix.1948, 9.x.1948, 10.x.1948, 11.xi.1948, 21.xi.1948, 21.vii.1949, 26.vii.1949, 8.ii.1950 (2); Jokjakarta, 6.viii.1975; Sindanglaya, 8.xii.1977; Bogor, 16.xii.1977; Purwodadi, 26.xii.1977; Lawang, 27.xii.1977; Bogor, 17.i.1978; Cipanas, Garut, 5.ii.1978; all seven on *Cocos nucifera* (3).

The aphids live on the lower side of leaves, younger populations almost without wax spread on the leaves, older populations with wax like snow flakes on the leaf; a leaflet may be completely crowded with the aphids, while the leaflet anterior and posterior to it lacks aphids, the leaflet petiole seems to form a barrier for the aphids to pass. Nearby leaves may be black due to sooty moulds.

Alatae were collected: early IV-1915, 5.ix.1948, 9.x.1948, 11.xi.1948, 21.vii.1949, 26.vii.1949, and 8.xii.1977.

Etymology.— *Rhapidis*, from *Rhapis*, a palm in Java cultivated in gardens. The name refers to the first palm species on which Van der Goot found this aphid (Van der Goot, 1917).

***Astegopteryx setigera* spec. nov.**  
(figs. 123-136)

Types.— Holotype (apterous viviparous female) from *Styrax benzoin* Dryand., Bogor, Java, Indonesia, no. 1241-5 -2, 9.i.1978, leg. D. Noordam. Paratypes: 46 apterae viviparae, and 78 alatae viviparae, same locality, host plant and date as holotype, leg. D. Noordam. Holotype and paratypes in the collection at the Rijksmuseum van Natuurlijke Historie, Leiden.

Two species of aphids which cause flower galls on *Styrax benzoin* Dryand. are known from Java: *Astegopteryx styracophila* Karsch, 1890, and the species to be described below. The two aphid species differ distinctly from one another, but it is surprising that the galls of these aphids are the same, and no characteristic is known that distinguishes the two galls. This could be why *A. setigera* spec. nov. was collected by Dr. P. van der Goot in 1918 and 1919, and by Dr. C. Franssen, in 1931 and 1932, but was not recognized as a species differing from *A. styracophila*.

Apterous viviparous female.— In life (pl. 16): Pale yellow, only antennae distally grey, tarsi very pale grey. Eyes black. Covered with a fine granular, flaky wax, the margins of the abdomen with a thick cushion, also where there are the siphunculi. Front of head shows small hairs. Larvae are of two types: One normal, developing into adult aphids, are dull due to wax which increases in quantity with age, the head with fine colourless hairs. The other type is shiny, without wax, the head orange coloured, with hairs of the same colour (on behaviour see below), the siphunculi slightly extending.

Macerated specimens.— (figs. 123-125; described from 13 specimens): Body length 1.01-1.50 mm, 1.6-2.3 times as long as it is wide.

Head.— Head across the eyes 225-247  $\mu$  wide, colourless, dorsally smooth, with a fine median suture. Frons (fig. 124) with 10-33 spines, some of these located dorsally and ventrally, the socket about five  $\mu$  high, and up to eight  $\mu$  wide at the base, length of the spines 6-18  $\mu$ , the largest diameter about two  $\mu$ . The interocular hairs are normal, 25-33  $\mu$  long; ventrally, posterior to the spines also about six normal hairs, 15-25  $\mu$  long. Antennae with four or five segments, colourless, but the last segment very pale brown, 200-273  $\mu$  long, 1.8-2.6 times as long as the body, 0.8-1.1 times the width of the head across the eyes; segments I and II almost smooth; III distally with some imbrications, dorsally smooth, ventrally with a few spinulae, in four-segmented antennae 1.3-1.7 times as long as IV, in five-segmented antennae III is 2.0-3.9 times as



long as IV, III plus IV is 1.6-2.4 times as long as V, longest hair 14-22  $\mu$ ; in antennae with five segments, IV dorsally with some smooth imbrications, ventrally imbrications with a few spinulae; the ultimate segment with some imbrications, ventrally with a few spinulae, distally with five setae. Length of antennal segments in four-segmented antennae: III, 83-90  $\mu$ ; IV, 51-63  $\mu$ ; in five-segmented antennae: III, 72-93  $\mu$ ; IV, 25-45  $\mu$ ; and V, 57-71  $\mu$ ; the processus terminalis 12-25  $\mu$  long. Eyes pale brown, with three ommatidia. Ultimate rostral segment 57-65  $\mu$  long, 0.86-0.96 times the length of the second tarsal segment of the hind leg; stylets 170-196  $\mu$  long.

Thorax.— Prothorax colourless, fused with the head, with two marginal hairs on each side, the dorsum with four anterior and two posterior hairs. Mesothorax and metathorax colourless, each with two marginal hairs and about 4-6 dorsal hairs. Legs almost colourless; tibiae smooth, of the fore leg 0.61-0.81 times as long as the width of the head across the eyes; longest hair of hind tibia 49-63  $\mu$ . First tarsal segments of fore- (fig. 125) and midleg with three, exceptionally with two hairs, of the hind leg with two, and 40-47  $\mu$  long. Second tarsal segments with some imbrications with a few spinulae, 0.21-0.25 times as long as the tibia of the hind leg, and 0.26-0.32 times as long as the width of the head across the eyes, with two dorsoapical hairs, 40-45  $\mu$  long, with expanded tips, two  $\mu$  wide at the tip. Empodial hairs of the hind leg 18-25  $\mu$  long. Length of segments of the hind leg: femur plus trochanter 224-255  $\mu$ , tibia 253-330  $\mu$ , first tarsal segment 23-27  $\mu$ , second tarsal segment 64-73  $\mu$ .

Abdomen.— Abdomen colourless, ventromarginally on segments I-VI distinct linear s-shaped wax glands, tergites VI-VIII with spinulose imbrications; number of hairs on the tergites: I, 4-8; II, 4-8; III, 4-8; IV, 5-9; V, 6-10; VI two, VII two, VIII, 6-11; length of hairs on tergite IV, 29-40  $\mu$ , ventrally on IV, 14-23  $\mu$ , on tergite VIII spinal hairs 43-51  $\mu$ . Siphunculi colourless, cone-shaped, about 15  $\mu$  high, 45  $\mu$  wide at the base, the pore very pale brown, 23-30  $\mu$  wide, with 3-6 hairs on the cone. Cauda transversely elongate e.g. 30  $\mu$  long, 110  $\mu$  wide, with an indistinct constriction on the ventral side only, width of the cauda about 110-135  $\mu$ , with 8-12 hairs, the longest 30-38  $\mu$ . Subanal plate without an incision in the middle, or an incision of at the most 10  $\mu$ , with 9-13 hairs which are lacking in the middle, longest 33-40  $\mu$ . Subgenital plate with 3-5 anterior hairs, the longest 20-27  $\mu$ , and 7-10 posterior hairs, the longest 16-23  $\mu$ . Gonapophyses two, each with 3-6 hairs, the longest 8-12  $\mu$ .

Alate viviparous female.— In life: Head and mesothorax black or very dark brown. Antennae black, segments I and II paler. Legs black, base of the femora paler. Prothorax green. Abdomen green with spots and stripes. Cauda yellow. Eyes black. Pterostigma dark green. Embryos observable on the underside of the alatae, yellow, with on four segments (presumably metathorax and abdominal segments I-III) a green spot, left and right of the median area; the four (two times two) middle spots are the most distinct and widest.

Macerated specimens.— (figs. 126-130; described from five specimens, and several characters from 15 others): Body length 1.43-1.85 mm.

Head.— (fig. 124). Head smooth, brown, width across the eyes 326-355  $\mu$ , the frons with 32-40 tiny spines, partly visible dorsally, and partly ventrally, each with a socket 3-4  $\mu$  wide, the centre observable from above as a transparent circular spot, three  $\mu$  wide; length of spines 4-10  $\mu$ , but sometimes one or two spines longer than 10  $\mu$ ; four hairs posterior to the paired ocelli, 16-20  $\mu$  long. Horns are lacking. Antennae five-segmented 540-610  $\mu$  long, 0.30-0.41 times as long as the body, and 1.7-1.9 times

the width of the head across the eyes; segment I brown, paler than the head, somewhat wrinkled; segment II brown, with some not very conspicuous longitudinal ridges dorsally and even more ventrally with spinulose imbrications, the spinulae 1-2  $\mu$  long; segments III-V (fig. 125) brown, with ring-shaped secondary rhinaria, the rings are not closed on the dorsal side, with an interval of usually 6-10  $\mu$ ; between the rhinaria are 3-5 concentric ring-shaped spinulose imbrications, mainly on the dorsal side with interconnections; the rhinaria are 3-4  $\mu$  wide, the intervals 8-14  $\mu$ . The primary rhinaria are between the annular rhinaria, and are moulded with them to a complex structure; segment III with 18-25, IV with 6-10, V with 6-10, V with 6-11 annular rhinaria; hairs are usually on the dorsal side, acute, segment III with three hairs, the longest 8-14  $\mu$ , IV with three, V with two, and six setae on the top of the processus terminalis. Length of segment III, 250-325  $\mu$ ; IV, 90-110  $\mu$ ; V, 112-130  $\mu$ ; segment III is 2.6-3.6 times as long as IV, 2.2-2.7 times as long as V, and 1.2-1.5 times as long as IV plus V; segment IV, 90-110  $\mu$  long, 0.7-1.0 times as long as V. The last rostral segment 65-74  $\mu$  long, 0.85-0.96 times as long as the second tarsal segment of the hind leg; length of the stylets 185-200  $\mu$ . Eyes compound, with the ocular tubercle extending sideways about 20  $\mu$ .

Thorax.— Prothorax margins very pale brown, with two hairs on each side, dorsum slightly darker with four anterior and two posterior hairs. Mesonotum dark brown. Fore wing (fig. 126) medial vein once branched, the hind wing with two oblique veins. Legs brown, the basal part of the femora paler, the distal end of femora and the base of tibiae darker on the dorsal side; femora smooth, tibiae smooth with almost smooth imbrications on the distal part, longest hairs 27-34  $\mu$ ; first tarsal segments with some smooth imbrications, exceptionally with a few spinulae, of fore leg (fig. 127) and midleg with three hairs, of hind leg with two 35-40  $\mu$  long; second tarsal segments with spinulose imbrications and of hind leg (fig. 128) dorsoapically with one hair expanded at the tip, and there 2.5-3.5  $\mu$  wide, the hair 39-43  $\mu$  long, the other hair acute, about 20  $\mu$  long; empodial hair of the hind leg 23-26  $\mu$  long. Length of hind segments: femur fused with trochanter, 356-383  $\mu$ , tibia 508-559  $\mu$ , first tarsal segment 29-30  $\mu$ , second tarsal segment 76-79  $\mu$ . The tibia of the fore leg is 1.2-1.3 times as long as the width of the head across the eyes, the hind tibia is 1.42-1.50 times as long as the hind femur plus trochanter; the second tarsal segment of the hind leg is 0.21-0.24 times as long as the width of the head across the eyes.

Abdomen.— (fig. 129). Abdominal segments I-V colourless, the dorsum of VI with two small pale brown patches with a hair in the centre, the margins of VII and a transverse band on the dorsum pale brown, VIII pale brown, all sclerotic parts with spinulose imbrications. Number of hairs on tergite I, 4-6; II, 4-6; III, 4-7; IV, 5-7; V, 4-7; VI two, exceptionally three, VII two, VIII, 4-6; length of hairs dorsally on segment IV, 22-35  $\mu$ , ventrally on IV, 20-23  $\mu$ , on tergite VIII spinal hairs 47-53  $\mu$ . Siphunculi located on segment VI, colourless or pale brown, about 12-15  $\mu$  high, 55  $\mu$  wide at the base, diameter of the pore 15-25  $\mu$ , the cone with 3-6 hairs, the longest 29-37  $\mu$ . Cauda colourless, without constriction, 103-138  $\mu$  wide at the base, with 9-11 hairs, the longest 31-40  $\mu$ . Subanal plate bilobed, the lobes pointing downwards 12-25  $\mu$  with respect to the middle part, with 12-14 hairs, the longest 29-40  $\mu$ . Subgenital plate with anteriorly 4-6 hairs, the longest 35-37  $\mu$ , posteriorly 8-12 hairs, the longest 37-41  $\mu$ . Gonapophyses two, each with 5-9 hairs, the longest 12-20  $\mu$ .

First stage larva of apterae (fig. 131, description of one or two specimens). Body

length 530-598  $\mu$ , width 250-270  $\mu$ . Length of head plus pronotum 186  $\mu$ , of the head across the eyes 198  $\mu$ . Frons colourless with 31-37 yellowish spines, 10-20  $\mu$  long with a widest diameter of 2-3  $\mu$ , with sockets 6-8  $\mu$  wide, and 3-5  $\mu$  high. Four interocular hairs, and four hairs anterior to those, 35-40  $\mu$  long. Antennae four-segmented, 153  $\mu$  long, length of hairs on segments II and III, 25  $\mu$ . Last rostral segment 65-75  $\mu$  long, 0.88-0.99 times as long as the second tarsal segment of the hind leg. Tibia of fore leg 118  $\mu$  long, distal hairs of fore-, mid- and hind leg 25-30  $\mu$  long. All first tarsal segments with two hairs, 35  $\mu$  long, but of the hind legs 45-50  $\mu$ . Second tarsal segments of fore leg dorsoapically with one hair expanded at the tip, and one shorter, acute hair; of the mid- and hind leg with two large hairs expanded at the tips, those of the hind leg 57-60  $\mu$  long. Empodial hairs 8-20  $\mu$  long. Wax glands lacking. Length of hairs on abdominal tergites I-VII, 20-30  $\mu$ ; on VIII, 40  $\mu$ . Siphunculi are lacking.

Second stage larvae of apterae are of two types: I with smaller spines on the frons of head than first stage larvae, normal last rostral segment and not extending siphunculi; this type eventually develops into an adult specimen. Type II, soldier-type, has enlarged orange-coloured frontal spines, a longer last rostral segment, and extending siphunculi. Both types are described below.

Second stage larva, type I (figs. 132, 133; description of four specimens): Body in life dull. Length 670-720  $\mu$ , width 320  $\mu$ , length of head plus pronotum 215  $\mu$ , of the head across the eyes 197  $\mu$ . Frons colourless with 30 almost colourless spines, 10-16  $\mu$  long, with a widest diameter of 1-2  $\mu$ . Antennae five-segmented, 185-200  $\mu$  long, segment III, 40-45  $\mu$  long, IV, 28-30  $\mu$ , V, 55-65  $\mu$ . The last rostral segment 55-63  $\mu$  long, 0.72-0.82 times as long as the second tarsal segment of the hind leg. Tibia of the fore leg 138-151  $\mu$ , of the hind leg 196-221  $\mu$  long. First tarsal segments of fore- and midleg with three hairs, of hind leg with two. Siphunculi located dorsally on the abdomen, the cone about eight  $\mu$  high, diameter of the pore 22  $\mu$ , and 4-6 hairs on the cone.

Second stage larva, type II (figs. 134, 135; description of some specimens). In life shiny with orange head. Body length 650-720  $\mu$ , width 245-270  $\mu$ , the body 2.5-2.7 times longer than it is wide, length of the head plus pronotum 212  $\mu$ , of the head across the eyes 184-202  $\mu$ . Frons pale brown with 31-37 orange yellow spines, 20-28  $\mu$  long, with a widest diameter of 4-5  $\mu$ , with sockets 10-12  $\mu$  wide, and 8-12  $\mu$  high. Four interocular hairs, and four hairs anterior to those, 40-45  $\mu$  long. Antennae five-segmented, 144-156  $\mu$  long, segment III, 23-30  $\mu$  long; IV, 20-24  $\mu$ ; V, 49-52  $\mu$ . The last rostral segment 64-70  $\mu$  long, 0.98-1.06 times as long as the second tarsal segment of the hind leg. The tibia of the fore leg 122-128  $\mu$  long, of the hind leg 178-190  $\mu$ . First tarsal segments of fore- and midleg with three hairs, of hind leg with two. Siphunculi on abdominal segment VI usually extending at the margin at an oblique angle backwards, cone-shaped, about 20  $\mu$  high, 50  $\mu$  wide at the base, diameter of the pore 20-25  $\mu$ , 4-6 hairs on the cone.

Embryo from alate viviparous female (fig. 136). In life yellow with four pairs of green spots, presumably on metathorax and three anterior abdominal segments, left and right of the middle.

Macerated specimens.— Description of one specimen: Body length 510  $\mu$ , head across the eyes 225  $\mu$ , anterior to the eyes eight hairs, four of these near the horns. Antennae four-segmented, 170  $\mu$  long, segment III, 51  $\mu$ ; IV, 67  $\mu$ ; length of hair on segment III, 29  $\mu$ . Horns pointed 25-35  $\mu$  long. Length of distal hairs of the hind tibia 33  $\mu$ . All first tarsal segments with two hairs, 45-50  $\mu$  long. Second tarsal segment of

the hind leg with one hair with expanded tip, 53  $\mu$  long, empodial hair 30  $\mu$  long. Wax glands arranged on each segment of the body in a straight line, on the head 3-4 on each side, on the prothorax 1-3, on the mesothorax 0-3, metathorax 0-3, abdominal segment I-III each 2-4; III, 3-4; IV, 3-5; V, 3-6; VI four; VII, 3-4; VIII, 4-6, with an interval in the middle of 12-24  $\mu$ . Abdominal tergites I-V with four hairs, dorsally on IV, 21  $\mu$  long, ventrally 12  $\mu$ ; tergites VI-VIII each with two hairs, on VIII, 30  $\mu$  long. Siphunculi are lacking.

Host plant records.— The aphid specimens from Java are from flower galls of *Styrax benzoin* Dryand., all collected at Bogor, the dates are indicated, and the collectors by number between parentheses: P. van der Goot (1), in the collection at the Laboratorium voor Entomologie, Wageningen; C. Franssen (2), in the collection at the Laboratorium voor Entomologie, Wageningen; D. Noordam (3), in the collection at the Rijksmuseum van Natuurlijke Historie, Leiden: 6.ix.1918, 10.iii.1919 (1); 7.i.1931, 2.i.1932 (2); 9.i.1978 (3). Alatae were present in all collections.

The aphids live inside the galls, the alatae leave the gall through the circular opening; also the second stage larvae type II frequently move out of the galls, and can sting; these larvae move the larval skins away from the gall with their heads.

Etymology.— *Setigera*, bearing bristles; especially first and second stage larvae have numerous conspicuous bristles on the head.

***Astegopteryx singaporensis*** (Van der Goot, 1918)  
(figs. 137-144)

*Oregma singaporensis* Van der Goot, 1918: 120.

*Astegopteryx singaporensis*; Eastop & Hille Ris Lambers, 1976: 97.

Types.— The material collected by Van der Goot in Singapore is presumably lost.

*Astegopteryx singaporensis* is one of the eight species collected from Javathathas pointed horns. It is rather well distinguishable from six of these, but frequently extremely difficult from *A. pallida*, especially because of the wide variability of the species. No alatae have been collected of *A. singaporensis*, meaning that apterae of such collections are also unknown, presumably the specimens with relatively the longest antennae, with five segments, and with disappearance of more wax glands than occurs in the material collected so far. The material collected by Van der Goot in Singapore is presumably lost, but two of his Bogor collections from 1918 and labelled by him as *Oregma singaporensis* were available, and were extremely useful in determining that my ten collections from Bogor undoubtedly belong to *A. singaporensis*.

Apterous viviparous female.— In life (pl. 17): Head, thorax and abdomen yellowish white or pale brownish yellow. Legs and antennae whitish, the processus terminalis or sometimes the whole last segment grey; tarsi pale brown. Very pale green spots are present on the body, but green is never present in the median area. Usually four spots are present, two on abdominal segment I, two on the metathorax but none close to the siphunculi; if sometimes two spots are present, these are on abdominal segment I. In some collections (no. 851, 1170, 1234, 1259) six spots were present, also two on the mesothorax. Medial to the siphunculi sometimes (no. 1259) on segment IV and posteriorly on V (all together four spots) a barely distinguishable pale green spot. The siphunculi are bright yellow or brownish yellow which colour also extends

anterior to the siphunculi on segments III and II. The body is dull, but the siphunculi somewhat shiny. Wax is present as a fringe at the margin of head, thorax and abdomen, but in some collections was lacking at margins of the thorax and the anterior abdominal segments, on some specimens even on segments V and VI. Sometimes wax accumulation occurs in the median area of the thorax, and abdominal segments I-IV; pleurally anterior to the siphunculi on segments III and II, and on abdominal segments VI and VII as a transverse band.

Macerated specimens.— (figs. 137-140; described from 22 specimens): Body length 1.2-1.7 mm.

Head.— Head across eyes 287-360  $\mu$  wide, colourless or very pale brown, smooth, the frontal dorsal hairs acute, 21-45  $\mu$  long; frontal horns triangular with straight or slightly concave inner sides, and usually convex outer sides, the tips pointed, with 6-8, rarely nine, hairs, increasing in length to the base, usually not longer than 8-14  $\mu$ ; length of horns 33-80  $\mu$ , 0.11-0.24 times as long as the width of the head across the eyes; wax glands in a group of 1-6, but lacking in one out of 70 specimens, diameter 5-40  $\mu$ ; length of hairs on the anterodorsal side 21-45  $\mu$ . Antennae with four or incompletely five segments, 220-382  $\mu$  long, 0.16-0.26 times as long as the body, and 0.71-1.1 times the width of the head across the eyes; antennae very pale brown, the processus terminalis pale brown, smooth, with some smooth imbrications; length of longest hair of antennal segment III, 23-35  $\mu$ . Length of antennal segment III, 91-195  $\mu$ ; of IV, 70-110  $\mu$ ; III is 1.2-2.0 times as long as IV, and 0.29-0.62 times the width of the head across the eyes. Ultimate rostral segment 49-55  $\mu$  long, 0.55-0.70 times the length of the second tarsal segment of the hind leg, without accessory hairs; stylets 210-240  $\mu$  long. Eyes very pale brown, with three ommatidia.

Wax glands present on the prothorax in 62 out of 70 specimens, as a group of 1-4 glands, marginally on the posterior side. Wax glands on mesothorax present in 58 out of 70 specimens, and on metathorax the same, in a group of 1-5, and 1-4 respectively. Legs colourless or very pale brown, the tarsi also, smooth or the second tarsal segment with some indistinct imbrications. Tibia of fore leg 0.53-0.91, the second tarsal segment of the hind leg 0.23-0.28 times as long as the width of the head across the eyes. First tarsal segments with 3, 2, 2 hairs. Second tarsal segment of hind leg with two dorsoapical hairs expanded at the tips, 41-55  $\mu$  long, empodial hair 7-32  $\mu$  long. Length of segments of hind leg: femur plus trochanter 247-362  $\mu$ , tibia 283-479  $\mu$ , first tarsal segment 29-32  $\mu$ , second tarsal segment 72-91  $\mu$ .

Abdomen.— Colourless. One large hair dorsal to the wax glands on each of segments I-VII; numbers of hairs on abdominal tergites: I, 7-11; II, 5-8; III, 3-8; IV, 4-9; V, 3-7; VI, two; VII, two; VIII, 5-9. Length of hairs on abdominal tergite IV, 36-57  $\mu$ , ventrally on segment IV, 22-34  $\mu$ , on tergite VIII, 45-78  $\mu$ . Wax glands, if present, are arranged marginally on each segment in a group, on segment I the glands number 1-5; on II, 1-6; III, 1-6; IV, 1-7; V, 1-5; VI, 1-5; VII, 1-5; and VIII two groups of 3-7. Wax glands were present on segment I in 57 out of 70 specimens, on II in 60; III, 61; IV, 64; V, 67; and on segments VI, VII, VIII in all specimens. Siphunculi almost colourless, the pore brown, cone-shaped; diameter of the pore 38-60  $\mu$ , of the base 90-180  $\mu$ , the cone up to about 60  $\mu$  high; on the cone 4-11 hairs. Cauda transversely elongate, the knob e.g. 27  $\mu$  long, 65  $\mu$  wide, and at the constriction 43  $\mu$  wide; the knob of the cauda 47-71  $\mu$  wide; cauda with 5-9 hairs, the longest 40-55  $\mu$ . Subanal plate bilobed, with 12-21 hairs, the longest 48-61  $\mu$ . Subgenital plate with 3-4 anterior hairs, the longest 33-39  $\mu$ , and 6-10 posterior hairs, the longest 22-35  $\mu$ . Gonapophyses two,

each with 3-7 hairs, 8-15  $\mu$  long.

First stage larva (fig. 141; description of one specimen): Body length 670  $\mu$ , length of head plus pronotum 192  $\mu$ ; head across eyes 206  $\mu$  wide, anterior to the eyes four hairs in a transverse row, about 35  $\mu$  long, and usually two long hairs close to the base of each horn. Antennae four-segmented, 205  $\mu$  long, segment III, 81  $\mu$ ; IV, 83  $\mu$ ; length of hair on segments II and III 30-40  $\mu$ . Horns pointed, 40  $\mu$  long and about 35  $\mu$  wide at the base. Tibia of fore leg 161  $\mu$  long, length of distal hair 47  $\mu$ ; distal hairs of hind tibia 43  $\mu$  long. All first tarsal segments with two hairs, about 50  $\mu$  long. Second tarsal segment of fore leg with one dorsoapical hair expanded at the tip, of mid- and hind leg with two. Marginal wax gland groups usually present on the head, and all segments of thorax and abdomen. Abdominal tergites I-IV with four hairs, V with four or less, VI, VII, VIII with two. Siphunculi are lacking.

Host plant records.— Specimens were collected in Java from bamboos, in the places and on the dates indicated, while the collectors are indicated by the number between parentheses: Van der Goot (1), in the collection at the Laboratorium voor Entomologie, Wageningen; D. Noordam (2), in the collection at the Rijksmuseum van Natuurlijke Historie, Leiden. Bamboo, Bogor, 3.v.1918, and 25.vii.1918 (1); *Bambusa schizostachyoides* Kurz, 16.xii.1977, this and all following Bogor, Kebun Raya (1); *Dendrocalamus giganteus* Munro, 2.iv.1975; *Melocanna bambusoides* Trin., 8.v.1975; *Schizostachyum blumii* Nees, 2.iv.1975, 8.ii.1978; *S. brachycladum* (Kurz) Kurz, 2.iv.1975, 8.ix.1976, 25.xii.1976, and 6.i.1978.

No alatae were collected.

The aphids are on the lower side of old leaves which frequently show yellow or brown patches.

Etymology.— *Singaporensis*, from Singapore the place where Van der Goot found this aphid for the first time.

Discussion.— The species is very similar to *A. pallida*, differences between the two species are mentioned in the key. It is somewhat puzzling that I found *A. singaporensis* only in the Botanical Garden of Bogor, and not on the commonly cultivated bamboos.

### *Astegopteryx styracophila* Karsch, 1890 (figs. 142-156)

*Astegopteryx styracophila* Karsch, 1890: 51; Hille Ris Lambers, 1933: 1, 3.

Types.— Neotype (apterous viviparous female, here designated), Bogor, 29.vi.1932, leg. C. Franssen, det. D. Hille Ris Lambers, in the collection at the British Museum (Natural History), London.

Karsch (1890) described *A. styracophila*, and Hille Ris Lambers (1933) determined that Karsch certainly described the aphids from flower galls of *Styrax*, and not those from leaf bud galls, the inhabitants of which Hille Ris Lambers described as *A. fransseni*. In that same publication, Hille Ris Lambers gave some additional characteristics of *A. styracophila* on the basis of material collected by W. Roepke, in May 1929, at Sibolangit, Sumatra on *Styrax*. There are, however several differences in the characteristics of material collected by Roepke and material collected by Franssen in

1932 at Bogor; and above all the fact that embryos inside alatae of Roepke material are similar to *Astegopteryx rappardi* embryos, persuaded me to decide to exclude the Roepke material from *A. styracophila*. So the description of the species presented in this publication is based on the material collected by Franssen in 1932, and by Van der Goot in 1918 and 1919 at Bogor. The female collected by Franssen is designated neotype because presumably the material described by Karsch has been lost.

Apterous viviparous female.

Macerated specimens.— (figs. 142-144; described from two specimens): Body length 1.17-1.33 mm.

Head.— Head across the eyes 235-258  $\mu$  wide, almost colourless, dorsally smooth, with anterior to the eyes about 15 hairs 30-38  $\mu$  long, and more anteriorly about 8-11 hairs 15  $\mu$  long, the frons with about 12 spines up to 10  $\mu$  long, four of these ventrally; lateral to a median suture, rudimentary dagger hairs (fig. 144) with a process 4-6  $\mu$  wide with the hair 4-6  $\mu$  long, but sometimes distinctly more sturdy than the other spines; posterior to these spines ventrally (fig. 143) about 15 hairs, 20-25  $\mu$  long. Antennae with five segments, almost colourless, but the last segment pale brown, 245-253  $\mu$  long, 2.2 times as long as the body, 0.98-1.04 times the width of the head across the eyes; segments I-III almost smooth, IV and V with imbrications with a few spinulae; segment III, 50-53  $\mu$  long, 1.2-1.6 times as long as IV, 0.8-1.1 times as long as V, length of hair 14-15  $\mu$ ; IV, 50-53  $\mu$  long, 0.7-0.8 times as long as V, and III plus IV, 1.8 times as long as V; segment V, 65-69  $\mu$  long, the processus terminalis 13-15  $\mu$ . Eyes pale brown, with three ommatidia. Ultimate rostral segment 63-65  $\mu$  long, 0.83 times the length of the second tarsal segment of the hind leg; stylets 186-197  $\mu$  long.

Thorax.— Prothorax colourless, fused with the head, with two marginal hairs on each side, the dorsum with four anterior and two posterior hairs. Meso- and metathorax colourless, each with two marginal hairs, and 4-7 dorsal hairs. Legs almost colourless; tibiae smooth, of the fore leg 187-195  $\mu$  long, 0.72-0.83 times as long as the width of the head across the eyes, longest hair of the hind tibia 45-55  $\mu$ . First tarsal segments of fore- and midleg with four hairs, of the hind leg with 2-3, and 30-35  $\mu$  long. Second tarsal segments with some imbrications with a few spinulae, 0.25-0.26 times as long as the tibia of the hind leg, and 0.29-0.33 times as long as the width of the head across the eyes, with two dorsoapical hairs, 43  $\mu$  long, with expanded tips, two  $\mu$  wide at the tip. Empodial hairs of the hind leg lacking. Length of segments of the hind leg: femur plus trochanter 250-251  $\mu$ , tibia 305-306  $\mu$ , first tarsal segment 25-28  $\mu$ , second tarsal segment 76-78  $\mu$ .

Abdomen.— Abdomen colourless, ventromarginally on segments I-VII distinct linear s-shaped wax glands, tergites VI-VIII with spinulose imbrications; number of hairs on the tergites: I about eight, II about eight; III, 8-10; IV seven; V, 8-9; VI three; VII two; VIII, 4-5; length of hairs on tergite IV, 27-30  $\mu$ , ventrally on IV, 15-20  $\mu$ , on tergite VIII, 38-45  $\mu$ . Siphunculi colourless, 50-53  $\mu$  wide at the base, with concentric somewhat spinulose imbrications, with five hairs; pore pale brown, 28  $\mu$  wide. Cauda transversely elongate, 116-118  $\mu$  wide, and 30-35  $\mu$  long, without a constriction, with 13-16 hairs, the longest 35  $\mu$ . Subanal plate without an incision, with 11-12 hairs, but not located in the median area, the longest 34-40  $\mu$ . Subgenital plate with four anterior hairs, the longest 20-22  $\mu$ , and 5-6 posterior hairs, the longest 16-17  $\mu$ . Gonapophyses two, each with 3-5 hairs, the longest 6-8  $\mu$ .

Alate viviparous female (figs. 145-151; described from eight specimens): Body length 1.33-1.67 mm, 2.0-2.6 times as long as it is wide.

Head.— (fig. 145). Head smooth, brown or black, the width across the eyes 335-440  $\mu$ ; anterior to the posterior margin of the paired ocelli and dorsal to the median ocellus 15-20 hairs, usually 4-8  $\mu$  long, but some longer, up to 16  $\mu$ , each with a socket three  $\mu$  wide, the centre observable from above as a transparent circular spot, 2-3  $\mu$  wide; about four interocular hairs, and 5-7 hairs posterior to the paired ocelli, 12-16  $\mu$  long. Horns are lacking. Antennae (fig. 146) with five segments, 470-535  $\mu$  long, 0.29-0.36 times as long as the body, and 1.4-1.5 times the width of the head across the eyes; segment I brown or black, somewhat wrinkled; segment II with some longitudinal ridges, and dorsally and ventrally with spinulose imbrications, the spinulae 1-2  $\mu$  long; segments III-V brown, with blackish ring-shaped rhinaria, the rings are not closed on the dorsal side, with a space of 4-20  $\mu$ ; between the rhinaria are 3-6 or more concentric ring-shaped spinulose imbrications, mainly on the dorsal side with interconnections; the rhinaria are 3-4  $\mu$  wide, the spaces 6-30  $\mu$ . The primary rhinaria are between the annular rhinaria, and are moulded with these to a complex structure; segment III with 10-15, IV with 6-8, V with 4-7 annular rhinaria; hairs are usually on the dorsal side, acute, segment III usually with three hairs, the longest 8-10  $\mu$ , IV with three, V with two, and six setae on top of the processus terminalis. Length of segment III, 190-232  $\mu$ , 1.8-2.2 times as long as IV, 1.6-2.0 times as long as V, and 0.8-1.0 times as long as IV plus V; segment IV, 92-112  $\mu$  long, 0.9-1.2 times as long as V. The last rostral segment 60-69  $\mu$  long, 0.73-0.83 times as long as the second tarsal segment of the hind leg; length of the stylets 180-187  $\mu$ . Eyes compound, with the ocular tubercle extending sideways about 20  $\mu$ .

Thorax.— Prothorax margins pale brown, with two marginal hairs on each side. Mesothorax brown or black. Fore wing medial vein once branched, the anal vein and the cubitus with a long common part, length 140-150  $\mu$  from the fork to the subcosta; the hind wing with two oblique veins. Legs brown, the basal half of the femora paler, the distal end of the femora and the base of the tibiae darker on the dorsal side; femora and tibiae smooth, length of longest hairs of the hind tibia 33-37  $\mu$ ; first tarsal segment almost smooth, of the fore- and midleg (fig. 148) with four hairs, of the hind leg with two, 33  $\mu$  long; second tarsal segments (fig. 149) with spinulose imbrications, and of the hind leg dorsoapically with one hair expanded at the tip, 41  $\mu$  long, the tip three  $\mu$  wide, the other hair acute, empodial hair of the hind leg, 25-27  $\mu$  long. Length of hind segments: femur fused with trochanter, 323-342  $\mu$ , tibia 456-480  $\mu$ , first tarsal segment, 30-32  $\mu$ , second tarsal segment 82-86  $\mu$ . The tibia of the fore leg is 1.0-1.1 times as long as the width of the head across the eyes, the hind tibia is 1.40-1.41 times as long as the hind femur plus trochanter; the second tarsal segment of the hind leg is 0.25 times as long as the width of the head across the eyes.

Abdomen.— (fig. 150). Abdominal segments I-VIII colourless, segments VII-VIII with spinulose imbrications. Number of hairs on tergite III, 6-7; IV, 4-7; V, 5-6; VI four; VII two, VIII four; length of hairs dorsally on segment IV, 20  $\mu$ , ventrally 16  $\mu$ , on tergite VIII, 35-45  $\mu$ . Siphunculi located on segment VI, colourless or pale brown, about 15  $\mu$  high, smooth, without a distinct border with the surrounding, with 3-6 hairs at a distance of 8-30  $\mu$  from the margin of the pore, the longest 25-30  $\mu$ ; the pore yellow or brown, diameter 16-25  $\mu$ . Cauda (fig. 151) colourless, without constriction, 105-145  $\mu$  wide at the base, and 35-38  $\mu$  long with 9-12 hairs, the longest 31-38  $\mu$ .



Subanal plate bilobed, with 10-14 hairs, the longest 31-38  $\mu$ . Subgenital plate with four anterior hairs, the longest 31-38  $\mu$ , and 5-9 posterior hairs, the longest 29-36  $\mu$ . Gonapophyses two, each with 6-8 hairs, the longest 8-10  $\mu$ .

Larvae of apterae are present in the collections as the soldier-type only. I assume this is a second stage larva, and a description is given below.

Second stage larva soldier-type (figs. 152-154; description of four specimens). Body length 640-790  $\mu$ , 2.4-2.6 times as long as it is wide, head across the eyes 197-215  $\mu$ . Frons pale brown with four spines, 22-25  $\mu$  long, with a widest diameter of 5-6  $\mu$ , with sockets 10-12  $\mu$  wide, and 10-12  $\mu$  high. Five interocular hairs, and posterior to those a transverse row of four hairs, 40-45  $\mu$  long. Antennae five-segmented, 147-166  $\mu$  long, segment III, 23-29  $\mu$  long; IV, 25-33  $\mu$ ; V, 55-60  $\mu$ . The last rostral segment 71-86  $\mu$  long, 1.11-1.32 times as long as the second tarsal segment of the hind leg. The tibia of the fore leg 137-147  $\mu$  long. First tarsal segments of fore- and midleg with four hairs, of the hind leg with two. Siphunculi on abdominal segment VI extending backwards at the margin, diameter of the pore 23-30  $\mu$ , with 3-5 hairs on the cone.

Embryo inside alate viviparous female (figs. 155, 156; description of one specimen). Body length 520  $\mu$ , head across eyes 150  $\mu$ , anterior to the eyes eight hairs; anterior and posterior to the eyes a row each of four hairs. Antennae four-segmented, 167  $\mu$  long, segment III, 47  $\mu$ ; IV, 65  $\mu$ ; length of hair on segment III, 35  $\mu$ . Horns pointed, 33  $\mu$  long. Length of distal hairs of the hind tibia 35  $\mu$ . All first tarsal segments with two hairs, 40-45  $\mu$  long. Second tarsal segment of the hind leg with one hair with expanded tip, 54  $\mu$  long, empodial hair 25  $\mu$  long. Wax glands arranged on each segment of the body in a straight line, on the head on each side 4-6, on the prothorax 3-4, mesothorax 1-4, metathorax 3-5, abdominal segments I-II, 3-5; III-VII, 4-5; VIII, 5-7, with a space in the middle of 6-14  $\mu$ . Abdominal tergite I with four hairs, II, 6-7; III, 4-6; IV six; V, 4-5; VI-VIII two, length of hairs dorsally on segment IV, 20  $\mu$ , ventrally 16-20  $\mu$ ; on VIII, 22  $\mu$ . Siphunculi are lacking.

Host plant records.— The specimens from Java are from flower galls of *Styrax benzoin* Dryand., all collected at Bogor, the dates are indicated, and the collectors by numbers between parentheses: A. Tschirch (1); P. van der Goot (2), in the collection at the Laboratorium voor Entomologie, Wageningen; C. Franssen (3), in the collection at the Laboratorium voor Entomologie, Wageningen and at the British Museum (Natural History), London: i.1889 (1); 11.ii.1919 (2); 29.vi.1932, 27.vii.1932 (3).

The aphids live inside the flower galls, the alatae leave the gall through the opening; second stage larvae of the soldier-type are mobile and frequently sting the wrists by inserting their stylets into the skin. The galls are described by Tschirch (1890), and as no. 1200 by Docters van Leeuwen-Reijnvaan and Docters van Leeuwen (1926).

Etymology.— *Styracophila*, loving *Styrax*, a genus of the Styracaceae, name given by Karsch (1890).

### *Astegopteryx unimaculata* spec. nov.

(figs. 157-158)

*Oregma insularis*; sensu Van der Goot, 1917: 186 [misidentification], not Van der Goot, 1912.

Types.— Holotype (aptera vivipara) from *Bambusa*, loc. Omboelan, 2.xii.1912, col-

lected P. v.d. Goot, det. *Oregma* spec. by P. v.d. Goot, no. 40-9-1. Paratypes same host plant, locality and date as the holotype, nos. 40-9-2 and 40-1-40-19. Holotype and paratypes in the collection at the Laboratorium voor Entomologie, Wageningen, the Netherlands.

Van der Goot (1912) described *Cerataphis insularis* (Van der Goot, 1912); the aphids were collected in 1909 by Jacobson at Semarang (Java), and the host plant and the colour in life were not known. The types of this material are lost, but co-types are present in the Museum van Natuurlijke Historie in Leiden, and this material in alcohol, was cleared and mounted by the author. Van der Goot (1917) collected aphids in East Java in 1912 and in subsequent years from bamboo and "redescribed" the material with the supposition that those aphids were the same as the material collected by Jacobson. In the "redescription" in 1917, Van der Goot does not mention why he thought his collected material belonged to the same species as that collected by Jacobson. In the key to the *Oregma* species, Van der Goot (1917 p. 173) writes that antennal segment IV is markedly shorter than segment V in the alatae of *O. insularis*, a characteristic which, according to Van der Goot, it has in common with *O. similis* and *O. lutescens*; I assume that Van der Goot thought that he could distinguish *O. similis* and *O. lutescens* because both, according to his description, have roundish wax glands which are at a distance from one another, while in *O. insularis* the wax glands are rectangular and very close to each other. It seems to me that Van der Goot used alatae to distinguish *O. insularis* from *O. striata*: *O. insularis* with antennal segment IV, 0.80 times as long as segment V, and in *O. striata* IV, 1.06 times as long as V. I do not think that the ratio of antennal segment IV to V can be used to distinguish alatae of *O. insularis* and *O. striata*, this ratio in *Astegopteryx bambusae* (synonym of *O. striata*) is 0.75-1.25, and the two remounted alatae of the Jacobson material are within this ratio. On the basis of the key of the Hormaphidinae in this paper, the Jacobson species is *Astegopteryx bambusae*, and *Cerataphis insularis* is a synonym. As a result, the species *O. insularis* described by Van der Goot in 1917 must be renamed.

Apterous viviparous female.— In life (pl. 18): Pale yellow sometimes pale greenish yellow, the head slightly brownish. Antennae and legs colourless or slightly brownish like the head, antennae distally grey, knees sometimes brownish, tarsi grey. One closed bluish green patch without interstices covers the body from metathorax to the distal margin of abdominal segment V or the anterior margin of VI; the patch is wider on metathorax and abdominal segments I and II, but nevertheless a margin is yellowish, and this together with the continuous white wax fringe is why, from a distance, the aphids appear as a blue green spot encircled by a white ring. Siphunculi reddish brown pore, round it yellow with a mixture of orange. Wax on head and marginally on all thorax and abdominal segments. Larvae pale yellow, head slightly brownish, usually two bluish green bands on metathorax and abdominal segment I extending far laterally, and four bands on the next abdominal segments extending laterally less far than the anterior bands; wax fringe on all segments of the body.

Macerated specimens.— (figs. 157, 158; described from six, some characters from 75 specimens chosen from 11 collections). Body 1.03-1.85 mm long.

Head.— Head across eyes 297-400  $\mu$  wide, smooth very pale brown, the frontal hairs acute, 42-52  $\mu$  long; frontal horns triangular to finger-shaped with parallel

sides, with rounded tips and usually bearing 8-10 hairs, which increase in length to the base of the horns, 4-10  $\mu$  long; length of horns 50-85  $\mu$ , 0.14-0.20 times as long as the width of the head across the eyes. A group of wax glands is present medial to the eyes with 1-5 glands, and is only lacking in one out of 65 specimens. Antennae with four or incompletely divided five segments, 205-385  $\mu$ , 0.18-0.22 times as long as the body, and 0.7-1.0 times the width of the head across the eyes; antennae pale brown, the last segment brown. Antennae smooth, the last segment only with some imbrications; segment III, 1.2-1.9 times the length of IV, length of longest hair of III, 20-36  $\mu$ . Length of segment III, 83-197  $\mu$ ; of IV, 70-106  $\mu$ . Ultimate rostral segment 48-68  $\mu$  long, 0.59-0.77 times the length of the second tarsal segment of the hind leg, longest distal hairs 26-32  $\mu$ , without accessory hairs; stylets 207-258  $\mu$  long. Eyes brown, with three ommatidia.

The head is fused with the pronotum and usually bears 18 hairs, six of which presumably on the pronotum. Marginally on the posterior side of the prothorax a group of wax glands with 1-5 glands. Mesothorax and metathorax each with two marginal hairs on each side, dorsally close to the wax gland groups, which consist of 3-7 and 3-5 glands respectively. Mesonotum with 3-8 hairs, metanotum with 4-9. Legs colourless or pale brown, the tarsi slightly darker, smooth, the second tarsi only with some imbrications. First tarsal segments with 3, 2, 2 hairs. Length of hairs of hind tibia at distal part 32-40  $\mu$ , of first tarsal segment of hind leg 37-42  $\mu$ ; dorsoapically second tarsal segment of hind leg with two hairs expanded at the tips, 40-52  $\mu$  long; empodial hairs of hind leg 25-30  $\mu$  long. The tibia of the fore leg is 0.56-0.81 times as long as the width of the head across the eyes. Length of segments of hind leg: femur plus trochanter 227-367  $\mu$ ; tibia 255-424  $\mu$ ; first tarsal segment 33-39  $\mu$ , second tarsal segment 68-89  $\mu$ .

Abdomen.— Abdominal segments marginally with almost colourless sclerites with one hair dorsal to the wax glands; number of hairs on the tergites: I, 7-13; II, 8-16; III, 9-18; IV, 8-15; V out of 75 specimens two with four hairs, seven with five, 13 with six, 24 with seven, 18 with eight, 10 with nine, and one with 10 hairs; VI out of 75 specimens three with two hairs, 20 with three, 27 with four, 13 with five, 10 with six, and two with seven hairs; VII usually with two hairs, but sometimes with 3-4; VIII with 7-12 hairs. Length of hairs on tergite IV, 44-56  $\mu$ , ventrally on segment IV, 20-36  $\mu$ ; on tergite VIII, 80-87  $\mu$ . Marginal wax glands present, on each segment arranged in a longitudinal group: on segment I the glands in a group number 2-5; on II, 3-5; III, 4-5; IV, 4-6; V, VI and VII, 3-6; VIII two groups of 4-6 with a space between the groups 60-112  $\mu$  wide, and bearing two hairs. The diameter of the largest wax glands of segment VIII varied from 14-38  $\mu$ , of segments III to VII from 17-48  $\mu$ . Siphunculi cone-shaped, about 50  $\mu$  elevated, the pore brown, diameter 40-75  $\mu$ , the cone very pale brown, with 4-13 hairs. Cauda transversely elongate, e.g. 25  $\mu$  long, 85  $\mu$  wide, and at the base somewhat constricted, 67  $\mu$  wide, with 7-9 hairs, the longest 42-60  $\mu$ ; knob of the cauda 65-95  $\mu$  wide. Subanal plate bilobed, with 15-20 hairs, the longest 50-64  $\mu$ . Subgenital plate with four anterior hairs, the longest 22-32  $\mu$ , and 5-11 posterior hairs, the longest 26-38  $\mu$ . Gonapophyses two, each with 1-6 hairs, 5-10  $\mu$  long.

Alate viviparous female.— In life (Van der Goot, 1917 and Dr F.W. Rappard

unpublished): Head brownish yellow to black. Thorax yellow or dirty brown. Abdomen with dark blackish green spot, rest of abdomen yellowish green or yellow. Siphunculi yellowish green or brown. Eyes and antennae black. Legs colourless, but tarsi and distal end of femora and tibiae black. Cauda yellowish green.

Macerated specimens.— (described from two specimens and Van der Goot, 1917). Body 1.80-2.16 mm long. Head across eyes 390-410  $\mu$  wide, smooth, dark brown, dorsally anterior to the paired ocelli with 4-5 hairs, posterior to the ocelli four hairs. Frontal horns 5-15  $\mu$  long, 0.02-0.04 times as long as the width of the head across the eyes. Antennae five-segmented, 520-640  $\mu$  long, 0.28-0.35 times as long as the body, and 1.3-1.6 times the width of the head across the eyes; segments III-V with ring-shaped secondary rhinaria, III with 22-32 rhinaria, IV with 9-12, and V with 10-13. Length of segment III, 255-300  $\mu$ ; of IV, 90-115  $\mu$ ; of V, 115-140  $\mu$ , and the tip of V distally to the ultimate rhinarium 8-15  $\mu$  - so V is 14-16 times as long as its tip. Segment III is 2.6-2.8 times as long as IV, and 2.1-2.2 times as long as V. Last rostral segment 60-63  $\mu$  long, 0.66 times as long as the second tarsal segment of the hind leg. First tarsal segments of fore leg with three hairs, of midleg with 2-3, of hind leg with two. The tibia of the fore leg is 0.9 times as long as the width of the head across the eyes. Siphunculi pale brown, cone-shaped, diameter of the pore 50-60  $\mu$ , of the base 150-170  $\mu$ , with 14-15 hairs. Cauda colourless, the knob 76  $\mu$  wide, with 8-9 hairs, the longest 45-47  $\mu$ . Subanal plate bilobed, with 17-19 hairs, the longest 50  $\mu$ . Subgenital plate with anteriorly 4-5 hairs, the longest 30-36  $\mu$ , and 11-13 posterior hairs, the longest 40-42  $\mu$ . Gonapophyses two, each with 7-9 hairs, 14-20  $\mu$  long.

First stage larva of aptera. Similar to those of *A. bambusae*, but in the collections available the head always bears wax glands, and abdominal tergite VI has two and sometimes three or four hairs.

Host plant records.— Specimens were collected in Java from the following host plants, in the places and on the dates indicated, while the collectors are indicated by numbers between parentheses: Van der Goot or Van der Goot (1917) (1), in the collection at the Laboratorium voor Entomologie, Wageningen or lost; F.W. Rappard (2), in the collection at the British Museum (Natural History), London; and D. Noordam (3), in the collection at the Rijksmuseum van Natuurlijke Historie, Leiden. Bamboo, Pasoeroean, Kepoeh, Lawang, Salatiga, about 1913 (1); *Bambusa* Oemboelan, 12.xii.1912 (1); bamboo, Bogor, 15.ii.1920 (1); *Gigantochloa*, Djember (80 m), 4.xi.1949 (2); *Bambusa blumeana* Bl. ex Schult.f., Tjoerah Dami (400 m), 7.ii.1950 (2); *B. blumeana* Bl. ex Schult.f., Bondowoso, 8.ii.1950, 25.iv.1950, 18.x.1950 (2); bamboo, Bogor, Kebun Raya, 8.vi.1975 (3); *Bambusa blumeana* Bl. ex Schult.f., Lawang (500 m), 28.xii.1977 (3); *B. blumeana* Bl. ex Schult.f., Purwodadi (300 m), 29.xii.1977 (3); bamboo, Bogor, Kebun Raya, 8.ii.1978 (3).

Alatae were observed by Van der Goot (1917), presumably from October to December, and by F.W. Rappard 25.iv.1950 and 18.x.1950. Large populations of apterae are on the lower side of the leaves, sometimes densely crowded. The species seems to be more common in the East of Java than in the West.

Etymology.— Unimaculata, having only one spot of colour.

Discussion.— See *A. bambusae*.

Genus *Cerataphis* Lichtenstein, 1882  
(figs. 159-244)

*Cerataphis* Lichtenstein, 1882: 75 (type species *Coccus lataniae* Boisduval, 1867).

Description (six species).— I. Morphs from galls of *Styrax* L. (one species). Apterous viviparous female.— In life: orange-yellow, with a thick cover of wax.

Macerated specimens.— Body oval, 1.1-1.4 mm long, 1.2-1.5 times as long as it is wide. Head dorsally smooth, without horns, but ventrally with 4-7 spines of which the middle two are the largest, 13-22  $\mu$  long, with rounded tips, on a process 14-16  $\mu$  wide at the base, and 11-18  $\mu$  high. Antennae with five segments, 0.22-0.25 times as long as the body, and 0.8-0.9 times the width of the head across the eyes. Eyes with three ommatidia. Last rostral segment without accessory hairs, 0.86-0.95 times as long as the second tarsal segment of the hind leg; stylets 260-305  $\mu$  long.

Prothorax fused with the head. Meso- and metathorax marginally and dorsally even with linear s-shaped wax gland structure. Tibiae smooth, the fore tibia 165-227  $\mu$  long, 0.52-0.61 times as long as the width of the head across the eyes. First tarsal segment of fore- and midleg with four hairs, of the hind leg with two. Second tarsal segment of the hind leg dorsoapically with two hairs with slightly expanded tips. Empodial hairs of the hind leg 20-31  $\mu$  long.

Abdomen colourless, marginally and dorsally, in any case anterior to the siphunculi with linear s-shaped wax glands; marginal wax gland groups are lacking. Tergite VI with 2-4 hairs, VII with two; length of hairs on tergite IV, 23-36  $\mu$ ; on VIII, 31-49  $\mu$ . Siphunculi present. Cauda broadly rounded without constriction, with 11-21 hairs, the longest 58-88  $\mu$ . Subanal plate bilobed with 10-15 hairs, the longest 58-72  $\mu$ . Subgenital plate with 3-5 anterior hairs, and 8-16 posterior hairs, the longest 25-41  $\mu$ . Gonapophyses two, each with 2-8 hairs.

First stage larva of apterae: The head ventrally with two spines, 11-18  $\mu$  long and 3-4  $\mu$  wide at the base; without siphunculi. Second stage larvae, with siphunculi, are of two types: I, normal larva developing after another larval stage into adults, the body 1.6-1.9 times as long as it is wide, length of the antennae 208-225  $\mu$ . Type II larvae are soldiers, the body 2.0-2.3 times as long as it is wide, length of the antennae 153-163  $\mu$ .

Alate viviparous female.— In life: Head, mesothorax and antennae black. Abdomen dark greyish green. Embryos violet with a greenish hue.

Macerated specimens.— Body length 1.4-1.6 mm. Head without horns. Anterior to the paired ocelli a row of 4-5 hairs, 20-28  $\mu$  long; anterior to these hairs, and partly ventrally on each side 5-6 hairs of which 2-6 are short, 12-18  $\mu$  but with a relatively wider base, two  $\mu$  instead of 1-1.5  $\mu$  wide. Antennae with five segments, 0.33-0.39 times as long as the body, antennal segment III, 2.6-3.3 times as long as IV; segment III with 15-21 annular rhinaria, IV with 3-6; V with 1-4. The last rostral segment without accessory hairs, 0.74-0.85 times as long as the second tarsal segment of the hind leg; stylets 235-255  $\mu$  long. The medial vein of the fore wing once branched, the hind wing with two oblique veins. Tibia of the fore leg 0.97-1.11 times as long as the width of the head across the eyes. First tarsal segments of the fore- and midleg with four hairs, length of hairs of the hind leg 35-41  $\mu$ . The second tarsal segment of the hind

leg dorsoapically with two hairs with expanded tips. Abdominal tergites I-VI colourless, VII with two small brown patches, VIII with a transverse band. Tergites I-IV each with 7-11 hairs, VIII with 5-9. Siphunculi situated on segment V, with 3-5 hairs. Cauda without a median processus, without a constriction, almost semi-circular, with 17-23 hairs. Subanal plate bilobed with a shallow incision, with 10-16 hairs, 41-53  $\mu$  long. Subgenital plate with 4-6 anterior hairs, and 9-15 posteriorly. Gonapophyses two, each with 5-7 hairs.

Embryos and first stage larvae from alatae with two horns without hairs on the head, lateral to the horns on each side three hairs, the middle with a larger process than the anterior and posterior hairs. Marginal wax gland groups on head, thorax and abdomen. Siphunculi are lacking.

II. Morphs from Palmae, Pandanaceae, Orchidaceae and Araceae.

Apterous viviparous female.— In life: Dull or shiny brown or black with a transverse furrow in the middle, with a flat, horizontal white fringe of wax along the border of the body.

Macerated specimens.— Body oval, 0.9-1.9 mm long, 1.1-1.6 times as long as it is wide, the dorsum wholly brown sclerotic, the margins crenulated, interrupted by a transverse furrow between the metanotum and abdominal tergite I, and by the free abdominal tergite VIII. Head fused with all thoracic tergites. From the posterior sides of the metathorax a marginal row of 90-106 wax glands passing without interruption ventrally to the eyes, and dorsally to the base of the antennae; usually four frontal wax glands are slightly raised, compared with the next glands. Ventrally to the frontal wax glands are two horns, smooth, acute and without hairs. Lateral and posterior to the horns on each side 4-6 hairs, of which one or more sometimes dagger-shaped. Antennae with four or five segments, 0.16-0.26 times as long as the body, and 0.47-0.85 times the distance between the outer margins of the eyes. Eyes with three ommatidia. Ultimate rostral segment without accessory hairs, 0.6-1.1 times as long as the second tarsal segment of the hind leg; stylets 270-700  $\mu$  long.

The tibia of the fore leg 0.29-0.44 times as long as the distance between the outer margins of the eyes. First tarsal segment of the fore leg with four hairs, of the midleg with three, of the hind leg with two. Second tarsal segment of the hind leg with usually all four apical hairs with expanded tips; empodial hairs of the hind leg 20-31  $\mu$  long.

Abdominal tergites I-VII fused, marginally crenulated by, on each side, 29-51 wax glands. Tergite I with 6-16 hairs, II with 4-13; III, 5-9; VII two; length of hairs on tergite IV, 4-49  $\mu$ . Siphunculi situated dorsally, without a distinct border fading into the surrounding area, the pore 20-48  $\mu$  wide, and 20-100  $\mu$  away from the margin of the body, with 1-5 hairs. Abdominal tergite VIII transversely elongate, the posterior margin with 11-19 wax glands, without any space, with 6-16 hairs of which two spinally, dorsal to the wax glands, 12-74  $\mu$  long; the other hairs ventral to the wax glands. Cauda transversely elongate, with a constriction, the knob 60-100  $\mu$  wide, with 4-15 hairs, the longest 57-100  $\mu$ . Subanal plate bilobed, with 14-22 hairs, the longest 67-108  $\mu$ . Subgenital plate with 3-8 anterior hairs, and 8-23 posterior hairs. Gonapophyses two, each usually with 3-6 hairs. In *C. freycinetiae* and *C. palmae* another type of apterous viviparous female occurs in populations with alatae, called by Van der Goot (1917) "Geschwister der Geflügelten". In these the wax glands disappear, horns are smaller, up to six of the ventral hairs are dagger-shaped, eyes and

siphunculi are situated marginally and the antennae have five segments.

First stage larvae without siphunculi.

Alate viviparous female.— Body length 1.3-2.0 mm. Head without horns, anterior to the paired ocelli 8-10 normal hairs 18-45  $\mu$  long; ventrally on the head sometimes 2-6 hairs with broader bases than those of other hairs, and these hairs fairly short, small dagger hairs. Antennae with five segments, 0.30-0.66 as long as the body, segments III-V with ring-shaped rhinaria, segment III with 24-40; IV, 7-20; and V, 2-24. The last rostral segment without accessory hairs, 53-101  $\mu$  long, 0.66-1.03 times as long as the second tarsal segment of the hind leg; length of the stylets 300-385  $\mu$ . The medial vein of the fore wing once branched, the hind wing with two oblique veins. The tibiae distally with some spinulose imbrications. First tarsal segments of the fore leg with four hairs, of the midleg with three, of the hind leg two or sometimes three. Second tarsal segment of the hind leg apically with two, or in *C. freycinetiae* sometimes with three hairs with expanded tips. Abdominal tergites colourless or tergite VII with two pale brown patches and VIII with a brown patch, tergites I-IV with 4-9 hairs, V with 2-6; VI, 3-5; VII, 2-4; VIII, 4-10, and 23-43  $\mu$  long. Siphunculi located on segment V colourless or with a pale brown area around the pore, with 2-7 hairs.

Cauda transversely elongate without a constriction, or with a knob with constriction, with 4-19 hairs, the longest 40-78  $\mu$  long. Subanal plate bilobed with 14-19 hairs, 41-94  $\mu$  long. Subgenital plate with 3-10 anterior, and 10-23 posterior hairs. Gonapophyses two, each with 4-9 hairs, the longest 10-18  $\mu$  long.

Embryos in alatae with horns and wax glands as first stage larvae of apterae or wax glands and horns are lacking.

Etymology.— *Cerataphis*, aphid with horns, name given by Lichtenstein (1882).

***Cerataphis fransseni* (Hille Ris Lambers, 1933)**  
(figs. 159-179)

*Astegopteryx fransseni* Hille Ris Lambers, 1933: 2.  
*Cerataphis fransseni*; Hille Ris Lambers, 1953: 94.

Types.— Holotype and paratypes, Buitenzorg (Java) on *Styrax benzoin* Dryand. forming galls, 29.vi.1932, leg. C. Franssen, in the collection at the British Museum (Natural History), London.

Apterous viviparous female.— Inside bud-gall. In life (pl. 19): Orange-yellow. Eyes dark red; covered with a thick layer of wax, which may be spread by movement of the specimens.

Macerated specimens.— (figs. 159-161; described from 12 specimens): Body oval, 1.09-1.45 mm long, 1.2-1.5 times as long as it is wide, with distinct border between pronotum and mesonotum, other segmental borders indistinct.

Head.— Head frons pale brown, the rest colourless, dorsally four frontal hairs 25-39  $\mu$  long, posterior to these two transverse rows of four, exceptionally five interocular hairs of about the same length; ventral to the four dorsal frontal hairs are two sturdy spines in the middle (fig. 160), 13-22  $\mu$  long, 6  $\mu$  wide at the base with rounded tips, on a process 14-16  $\mu$  wide at the base, and 11-18  $\mu$  high; next to the two spines are 2-5 smaller spines, and 1-2 normal small hairs. Antennae with five seg-

ments, pale brown, the last segment darker, 257-335  $\mu$  long, 0.22-0.25 times as long as the body, 0.81-0.93 times as long as the distance between the outer margins of the eyes; segments I and II almost smooth; III dorsally and ventrally with spinulose imbrications, length of longest hair 23-31  $\mu$ , IV and V with more distinct spinulose imbrications than III; length of segment III, 72-106  $\mu$ , 1.6-2.1 times as long as IV, 1.0-1.4 times as long as V; and III plus IV, 1.6-2.2 times as long as V; length of segment IV, 45-61  $\mu$ , 0.62-0.78 times as long as V; V, 67-82  $\mu$  long, distally with five setae. Eyes brown, with three ommatidia. Ultimate rostral segment 69-83  $\mu$  long, 0.86-0.95 times the length of the second tarsal segment of the hind leg; stylets 260-305  $\mu$  long.

Thorax.— Prothorax colourless, fused with the head, with two marginal hairs on each side, the dorsum with 4-7 hairs. Mesothorax and metathorax colourless, evenly with linear s-shaped wax gland structure (fig. 161), marginally and dorsally, visible at 400 times magnification only, each with two marginal hairs and 6-9 dorsal hairs. Legs pale brown, smooth, also the tarsi; fore tibia 0.52-0.61 times as long as the distance between the outer margins of the eyes, hind tibia longest hair 43-55  $\mu$ , a distal spine is lacking; chaetotaxy of first tarsal segments 4, 4, 2 or exceptionally three, length of hairs 41-55  $\mu$ , 0.47-0.64 times as long as the second tarsus of the hind leg; second tarsus of fore leg dorsoapically with one large hair, of mid- and hind leg with two large hairs, with slightly expanded tips, length of hair of hind leg 47-59  $\mu$ ; length of empodial hair of hind leg 20-31  $\mu$ , in one specimen 8  $\mu$ . Length of segments of the hind leg: femur plus trochanter 232-295  $\mu$ , tibia 259-338  $\mu$ , first tarsal segment 28-32  $\mu$ , second tarsal segment 76-88  $\mu$ .

Abdomen.— Abdomen colourless, marginally and dorsally in any case anterior to the siphunculi with linear s-shaped wax glands, tergite VI-VIII with spinulose imbrications; number of hairs on the tergites; I, 8-9; II, 7-10; III, 8-10; IV, 7-10; V, 4-7; VI, 4-6; VII, 4-5; VIII, 6-11; length of hairs on tergite IV, 23-36  $\mu$ , ventrally on IV, 25-33  $\mu$ ; on tergite VIII spinal hairs 31-49  $\mu$ , the longest lateral hairs slightly longer. Siphunculi cone-shaped, about 15  $\mu$  high, and 65-85  $\mu$  wide at the base, close to the pore pale brown with some concentrically arranged spinulose imbrications, without linear s-shaped wax glands, the pore brown, 29-40  $\mu$  wide, with 3-5 hairs on the cone. Cauda broadly rounded without constriction, e.g. 55  $\mu$  long, and 140  $\mu$  wide at the base, width of the cauda 116-146  $\mu$ , with 11-21 hairs, the longest 58-88  $\mu$ . Subanal plate bilobed with a shallow incision in the middle, with 10-15 hairs which are lacking in the middle, longest 58-72  $\mu$ . Subgenital plate with 3-5 anterior hairs, the longest 25-39  $\mu$ , and 8-16 posterior hairs, the longest 25-41  $\mu$ . Gonapophyses two, each with 2-8 hairs, the longest 6-10  $\mu$ .

Alate viviparous female.— In life: Head, mesothorax and antennae black, prothorax dark green, abdomen dark greyish green, cauda grey. Legs black, but base of the femora pale. Pterostigma dark greenish blue. Embryos violet with a greenish hue.

Macerated specimens.— (figs. 162-170; described from 10 specimens): Body length 1.38-1.62 mm.

Head.— (fig. 162). Head brown, smooth with wrinkles around the lateral ocelli and the posterior margin of the head, width across the eyes 350-392  $\mu$ . Anterior to the paired ocelli a transverse row of four or five hairs, 20-28  $\mu$  long; anterior to these hairs and partly on the ventral side 5-6 hairs on each side of which all together 4-6 look like small dagger-hairs (fig. 163): short with a relatively wide base; posterior to the paired ocelli 4-5 hairs. Antennae five-segmented 520-595  $\mu$  long, 0.33-0.39 times



as long as the body, and 1.4-1.6 times the width of the head across the eyes; segment I brown, somewhat wrinkled; segment II brown with longitudinal ridges, and distally spinulose imbrications, the spinulae up to two  $\mu$  long; segments III-V (fig. 164) brown, with ring-shaped secondary rhinaria, the rings are not closed on the dorsal side, with a space of 6-20  $\mu$ ; between the rhinaria are 3-7 or more concentric ring-shaped spinulose imbrications, mainly on the dorsal side with interconnections; the rhinaria are 2-3  $\mu$  wide, the spaces 8-20  $\mu$  or more. The primary rhinaria are between the annular rhinaria, and are moulded with them to a complex structure; segment III with 15-21, IV with 3-6, V with 1-4 annular rhinaria; hairs are usually on the dorsal side, segment III with 3-4 hairs, the longest 16-24  $\mu$ , IV with two, V with one and five setae on the top of the processus terminalis. Length of segment III, 245-290  $\mu$ ; IV, 86-109  $\mu$ ; V, 90-116  $\mu$ , segment III is 2.6-3.3 times as long as IV, 2.7-3.2 times as long as V, and 1.3-1.6 times as long as IV plus V; segment IV is 0.9-1.0 times as long as V. The last rostral segment is (fig. 165) 62-78  $\mu$  long, without accessory hairs, 0.74-0.85 times as long as the second tarsal segment of the hind leg; length of the stylets 235-255  $\mu$ . Eyes compound, with the ocular tubercle extending sideways about 20  $\mu$ .

Thorax.— Prothorax margins and dorsum with a brown transverse band. Mesonotum dark brown. Fore wing (fig. 166) medial vein once branched, the hind wing with two oblique veins. Legs brown, the basal part of the femora slightly paler, distal end of femora and base of tibiae darker on the dorsal side; femora smooth, tibiae with spinulose imbrications on the distal half, tibia of fore leg 0.97-1.11 times as long as the width of the head across the eyes; hind tibia without a sturdy distal spine, longest hairs 20-28  $\mu$ ; chaetotaxy of first tarsal segments (fig. 167) 4, 4, 2 or sometimes 4, 4, 3, the two middle hairs half the length of the lateral, length of hairs of the hind segment 35-41  $\mu$ , 0.38-0.48 times as long as the length of the second tarsal segment of the hind leg; second tarsal segments with spinulose imbrications, of fore leg dorsoapically with one, more sturdy, hair expanded at the tip, of mid- and hind leg (fig. 168) with two, of hind leg 41-49  $\mu$  long, the tips 3-4  $\mu$  long. Length of hind segments; femur fused with trochanter, 334-350  $\mu$ , tibia 425-464  $\mu$ , 1.27-1.36 times as long as the femur, first tarsal segment 29-32  $\mu$ , second tarsal segment 84-92  $\mu$ .

Abdomen.— (fig. 169). Abdominal tergites I-IV colourless, the tergite of VII with two small very pale brown patches with one hair, VIII with a pale brown transverse band, all sclerotic parts with spinulose imbrications. Number of hairs on tergite I, 8-11; II, 7-10; III, 7-11; IV, 7-11; V, 3-6; VI, 3-6; VII two; VIII, 5-9; length of hairs dorsally on segment IV, 20-29  $\mu$ , ventrally on IV, 22-30  $\mu$ , on tergite VIII spinal hairs 40-47  $\mu$ , the lateral of the same length. Siphunculi situated on segment V, pale brown near the pore, the colour gradually fading into the surrounding area, about 70  $\mu$  wide at the base but the border usually indistinct, with 3-5 hairs, 22-25  $\mu$  long; the pore pale brown, 27-35  $\mu$  wide. Cauda (fig. 170) colourless almost semi-circular, without constriction, e.g. 61  $\mu$  long, 140  $\mu$  wide at the base; cauda 115-159  $\mu$  wide, with 15-23 hairs, the longest 40-53  $\mu$ . Subanal plate bilobed with a shallow incision, with 10-16 hairs, the longest 41-53  $\mu$ . Subgenital plate anteriorly with 4-6 hairs, the longest 27-40  $\mu$ , posteriorly with 9-15 hairs, the longest 29-40  $\mu$ . Gonapophyses two, each with 5-7 hairs, the longest 10-18  $\mu$ .

First stage larva of apterae (figs. 171-173): Body length 560-610  $\mu$ , width 250-300  $\mu$ , 2.0-2.3 times as long as it is wide, width of the head across the eyes 184-205  $\mu$ . Head colourless, dorsally with a row of four interocular hairs, and two other rows of

four hairs anterior to these, length of the hairs about 35  $\mu$ , ventrally two yellowish spines, sometimes bifurcated, 11-18  $\mu$  long and 3-4  $\mu$  wide at the base. Antennae with five segments, 180-208  $\mu$  long, 0.92-1.07 times as long as the width of the head across the eyes; length of segment III, 27-33  $\mu$ ; IV, 25-33  $\mu$ , and V, 63-73; segment III is 0.9-1.2 times as long as IV, and 0.43-0.55 times as long as V. Last rostral segment 81-94  $\mu$  long, 0.94-1.15 times as long as the second tarsal segment of the hind leg, the distal 23-30  $\mu$  brown, with parallel sides, 8  $\mu$  wide at the tip, and higher up the same or one  $\mu$  wider; shortest distance from base of distal hair to end of the rostrum 38-45  $\mu$ , i.e. more than in second stages. Tibia of the fore leg 129-144  $\mu$  long, 0.70-0.77 times as long as the width of the head across the eyes, length of hairs of the tibiae about 25-35  $\mu$ . All first tarsal segments with two hairs, 35-45  $\mu$  long. Second tarsal segments of fore leg dorsoapically with one hair slightly expanded at the tip, the mid and hind leg with two, about 50  $\mu$  long. Empodial hairs 6-20  $\mu$  long. Wax glands are lacking. Length of hairs on abdominal tergites about 25-40  $\mu$ . Siphunculi are lacking. It is apparent from first stage larvae that are beginning to moult, that there are two types of second stage larvae. Some characters of these types are reported below in comparison with first stage larvae, while the two types are denominated by I and II.

I. Normal second stage larva. (figs. 174, 175). Develop after another larval stage into adults. Length of body 640-860  $\mu$ , width 430-520  $\mu$ , 1.6-1.9 times as long as it is wide, and 1.7 times as wide as the distance of the outer margins of the eyes. Length of the two ventral spines on the head 20-25  $\mu$ . Length of the antennae 208-225  $\mu$ , of segment III, 45-52  $\mu$ ; of IV, 35-45  $\mu$ ; of V, 58-69  $\mu$ . Last rostral segment 68-74  $\mu$  long, the distal 20-23  $\mu$  triangular, brown, 2.0-2.5 times wider at the upper part than at the base, shortest distance from base of distal hair to end of the rostral segment 27-31  $\mu$ . Tibia of the fore leg 151-165  $\mu$  long. Chaetotaxy of first tarsal segments usually 4, 4, 2. Siphunculi diameter of the pore 20-24  $\mu$ .

II. Second stage larvae (figs. 176, 177). Which do not develop to another stage, are mobile and sting, e.g. on the hands. Length of body about as first stage larvae, 545-630  $\mu$ , width 260-280  $\mu$ , 2.0-2.3 times as long as it is wide, width of the head across the eyes 184-205  $\mu$ . Length of the two ventral spines on the head longer than in first stage larva and normal second stage larva, 27-30  $\mu$ . Length of the antennae shorter than in first stage larvae, 153-163  $\mu$ , of segment III, 29-35  $\mu$ ; of IV, 25-30  $\mu$ , and of V, 48-55  $\mu$ . Last rostral segment shorter than in first stage larva, 73-76  $\mu$  long, 0.97-1.10 times as long as the second tarsus of the hind leg, the distal 22-27  $\mu$ , brown with parallel sides, eight  $\mu$  wide at the tip, and higher up the same or one  $\mu$  wider; shortest distance from base of distal hair to end of the rostrum 29-33  $\mu$ . Tibia of the fore leg 125-141  $\mu$  long, 0.62-0.71 times as long as the width of the head across the eyes. First tarsal segments of fore- and midleg with three or four hairs, of hind leg with two. Siphunculi diameter of the pore 18-20  $\mu$ .

First stage larvae, the first day after birth from alatae (figs. 178, 179) from galls of *Styrax benzoin*. In life embryos somewhat violet with a green hue, but without green spots. Length 445-545  $\mu$ , 1.7-2.2 times as long as it is wide. Head fused dorsally with the pronotum, pale brown, the margins anterior to the eyes crenulated, with three transverse rows of four hairs, the middle frontal hairs slightly curved, nearly acute or somewhat capitate, 13-18  $\mu$  long; head ventrally anterior to the rostrum pale brown, with two horns without hairs 25-29  $\mu$  long, 14-20  $\mu$  wide at the base, space between the bases 0-5  $\mu$ ; lateral to the horns three hairs on each side (as in *C. palmae*):

The anterior of these 38-45  $\mu$  long on a process with a diameter of 6-7  $\mu$ , the middle hair 35-45  $\mu$  long, diameter of the process 7-10  $\mu$ , the posterior hair 31-35  $\mu$  long, diameter of the process 4  $\mu$ . Antennae pale brown, 181-205  $\mu$  long, 0.94-1.02 times as long as the distance between the outer margins of the eyes, with four segments, III and IV with spinulose imbrications, III, 60-63  $\mu$  long, IV, 74-84  $\mu$ . Eyes brown, with three ommatidia; distance between the outer margins of the eyes 189-218  $\mu$ . Prothorax with marginally about 11 wax glands but rather indistinct, two marginal hairs on each side, dorsum with two hairs. Mesothorax marginally about 12 wax glands on each side, the metathorax with about nine. Legs pale brown, the tibiae on the ventral side with spinulose imbrications, length of fore tibia 116-123  $\mu$ , 0.56-0.62 times as long as the distance between the outer margins of the eyes. All tarsal segments with two hairs, second tarsal segments with spinulose imbrications. Abdominal segments I-VII each with a marginal sclerite with 4-7 wax glands, hairs of tergites blunt or acute, 5-12  $\mu$  long. Abdominal segment VIII with 12-14 wax glands along the posterior margin.

Host plant records.— The aphid specimens from Java are from bud galls of *Styrax benzoin* Dryand. all collected from plantations of the tree at Bogor: 1.ix.1919, leg. P. van der Goot, in the collection at the Laboratorium voor Entomologie, Wageningen; 29.vi.1932, leg. C. Franssen, in the collection at the British Museum (Natural History), London; 9.i.1977, leg. D. Noordam, in the collection at the Rijksmuseum van Natuurlijke Historie, Leiden. Alatae were collected in all collections mentioned above.

The aphids live inside the galls, the alatae leave the galls through the slit at the top; also second stage larvae type II move out through the slit. The galls are described by Tschirch (1890), and Doctors van Leeuwen - Reijnvaan & Doctors van Leeuwen (1926: 453, No. 1201; 1941: 217).

Etymology.— Fransseni, named after Dr C.J.H. Franssen who collected this aphid described by Hille Ris Lambers (1933).

Discussion.— Hille Ris Lambers (1953) mentions that living migrants from the galls produce typical *Cerataphis* larvae, but that it was not possible to state which species was associated with the gall on *Styrax*. When comparing first stage larvae from alatae of *Cerataphis fransseni* with those of apterae on secondary hosts, only *C.palmae* agrees well, one with the other, and especially the anterior ventral side of the head, which shows: lateral to the horns three hairs on each side, the middle one with a larger process than the anterior and posterior hairs; the length of this middle hair in *C.fransseni* is 35-45  $\mu$ , and some specimens in two out of eight collections of *C.palmae* also have long middle hairs; it is tempting to consider long middle hairs as a characteristic of specimens of new starting populations. No other first stage larvae of apterae of the Javanese *Cerataphis* species have the hairs on the ventral side of the head in a similar way, and so it is likely that *C.fransseni* is a synonym of *C.palmae*.

***Cerataphis freycinetiae* Van der Goot, 1917**  
(figs. 180-194)

*Cerataphis freycinetiae* Van der Goot, 1917: 166.

Types.— Lectotype, apterous viviparous female, plant species not mentioned, but according to Van der Goot (1917: 168) *Freycinetia* spec., Lawang, Java, 1913; leg. P. van der Goot. Paralectotypes: 13 apterae viviparae, all of the second type, partly fragmentary on four slides with the same data as the lectotype. Lectotype and paralectotypes in the collection at the Laboratorium voor Entomologie, Wageningen.

In this species apterae viviparae females occur, just as in *C. palmae* (Ghesquière, 1934) in two types. The first type is fully described below. The second type is called: Geschwister der Geflügelten (Van der Goot 1917: 166), has short horns, and differs in many other characteristics from the first type; no description is given here, but after the description of the first type the distinguishing marks of the second type are enumerated.

Apterous viviparous female.— In life (pl. 20): Body black, dull due to a fine granular surface, with a transverse furrow in the middle. Siphunculi black. Antennae pale at the basal part, distally black. Legs pale brown. Eyes black. A flat, horizontal white fringe of wax along the border of the body, almost without any interruption. Smallest larvae green, at a later age dirty green, greenish brown with brown head and prothorax and some brown patches on the middle of meso- and metathorax. In some populations (Van der Goot, 1917) dull dirty brown specimens are also present without a wax fringe.

Macerated specimens.— (figs. 180-182, 184; described from 10 specimens): Body oval, 1.30-1.63 mm long, and 925-1170  $\mu$  wide, 1.3-1.5 times as long as it is wide, the dorsum wholly brown sclerotic, margins crenulated, interrupted by a transverse furrow between metanotum and abdominal tergite I, and by the free abdominal tergite VIII.

Head.— Head fused with all thoracic terga, dorsally almost smooth, densely with dots of less than one  $\mu$ . Marginally, from the posterior sides of the metathorax a row of about 90 wax glands without interruptions passing ventrally to the eyes, and dorsally to the base of the antennae; four frontal wax glands are slightly raised compared with the next glands; the glands have facets, 5-6  $\mu$  wide, the borders of which are dotted lines. Length of the frontal dorsal hair 33-51  $\mu$ . Ventral to the frontal wax glands are two horns (fig. 181), smooth, acute, and without hairs, 50-76  $\mu$  long, 0.11-0.15 times as long as the distance between the outer margins of the eyes. Posterolateral to the horns, on each side, is a dagger hair 12-16  $\mu$  long on a process 1-15  $\mu$  in diameter, in front of which are two hairs each with a process diameter of 6-9  $\mu$  (normal hair process 5-6  $\mu$ ). Antennae brown, darker to the end, 225-270  $\mu$  long, 0.16-0.19 times as long as the body, 0.47-0.55 times the distance between the outer margins of the eyes, with four segments; segment III, 100-115  $\mu$  long, smooth, distally with some smooth imbrications, longest hair 21-31  $\mu$ , segment IV, 60-70  $\mu$  long, with spinulose imbrications; segment III, 1.5-1.8 times as long as IV. Ultimate rostral segment 57-68  $\mu$  long, 0.79-0.89 times the length of the second tarsal segment of the hind leg, without accessory hairs; stylets 325-435  $\mu$  long. Eyes darker brown than the head, situated marginally or dorsally, with three ommatidia.

The head is fused dorsally with the three thoracic segments, and sometimes a transverse furrow is present in the middle between pronotum and mesonotum; three transverse rows of hairs are present on the head, the pronotum bears 4-8 hairs, the mesonotum 6-11, and the metanotum 10-15. Legs brown, smooth, also the tarsi. Tibia of the fore leg 181-220  $\mu$  long, 0.37-0.44 times as long as the distance between the outer margins of the eyes. Chaetotaxy of first tarsal segments 4, 3, 2, hairs of the hind

leg expanded at the tips, 35-47  $\mu$  long, 0.50-0.60 times as long as the second tarsus of the hind leg; the second tarsus of the hind leg apically with usually four hairs expanded at the tips, the longest 40-45  $\mu$ ; empodial hairs 20-24  $\mu$  long. Length of segments of the hind leg: femur plus trochanter 245-310  $\mu$ , tibia 267-310  $\mu$ , 1.02-1.03 times as long as the femur, first tarsal segment 33-37  $\mu$ , second tarsal segment 57-68  $\mu$ .

Abdomen.— Segments I-VII fused, dorsally with indistinct furrows between the segments, marginally crenulated by, on each side, 43-48 wax glands; the glands rectangular with rounded corners, e.g. 27  $\mu$  long, 15  $\mu$  wide; dorsal to the glands, on each side, on each segment, one marginal hair, and ventrally on segment V, 4-8 marginal hairs, on VI, 5-10; and on VII, 4-7; tergite I with 10-16 hairs, II, 8-13; III, 6-9; IV, 4-9; V, 1-4, usually two; VI and VII two; length of hairs on tergite IV, 40-49  $\mu$ , ventrally on IV, 20-26  $\mu$ . Siphunculi cone-shaped, about eight  $\mu$  elevated, the pore darker brown than the surroundings, 20-38  $\mu$  wide, with 2-5 hairs, 33-41  $\mu$  long. Abdominal segment VIII dorsally free, transversely elongate, e.g. 72  $\mu$  long, 270  $\mu$  wide, the posterior margin with 15-17 wax glands, without any interval, with 11-16 hairs, two of which spinally, dorsal to the wax glands, 51-74  $\mu$  long, the other hairs lateral, ventral to the wax glands, the longest 74-88  $\mu$ . Cauda (fig. 182) transversely elongate, e.g. 23  $\mu$  long, the knob 76  $\mu$  wide, the constriction 51  $\mu$ , and the base of the cauda 94  $\mu$  wide, with 6-9 hairs, the longest 76-92  $\mu$ ; knob of the cauda 67-81  $\mu$  wide. Subanal plate bilobed, with 19-20 hairs, the longest 84-98  $\mu$ . Subgenital plate with 3-5 anterior hairs, about 40  $\mu$  long, and 12-19 posterior hairs, 33-42  $\mu$  long. Gonapophyses two, each with 5-6 hairs, the longest 7-12  $\mu$ .

Second type apterous viviparous female (figs. 183, 185). Frontal horns lacking or up to 14  $\mu$  long. Two dagger hairs are present as in first type apterae, but also 1-4 hairs anterior to these are short and thick and located on tubercles each with a diameter of 10-12  $\mu$ . The four wax glands dorsal to the location of the horns are lacking; usually the wax glands medial to the antennae are present, but the glands anterior to the eyes are more often imperfectly developed. Antennae with five segments, 255-295  $\mu$  long, 0.18-0.22 times as long as the body, 0.53-0.63 times the distance between the outer margins of the eyes; segment III, 62-90  $\mu$  long, 1.1-1.8 times as long as IV, 0.9-1.4 times as long as V, and 0.5-0.8 times as long as IV plus V; segment IV, 47-63  $\mu$  long, 0.7-0.9 times as long as V; segment V, 63-71  $\mu$  long. The marginal wax glands of the thoracic segments fully or imperfectly developed. Margins of abdominal segments V-VII less curved, and siphunculi located closer to the margins than in first type apterae. Marginal wax glands imperfectly or well-developed on the anterior abdominal segments, on segments V-VII imperfectly developed, and usually lacking on segment VIII.

Alate viviparous female.— In life: Dull, black (F.W. Rappard unpublished).

Macerated specimens.— (figs. 186-192; described from six specimens from Irian Jaya, Indonesia). Body length 1.18-1.33 mm, 2.0-2.6 times as long as it is wide.

Head (fig. 186).— Head smooth, brown, width across the eyes 385-405  $\mu$ . The head ventrally (fig. 187) with normal thin hairs, 20-25  $\mu$  long, but lateral to the median ocellus, close to the base of the antennae one small dagger hair on each side, 14-20  $\mu$  long, and close to the base 2-3  $\mu$  wide, with a larger process than normal hairs; dorsal to the median ocellus two curved hairs, anterior to the paired ocelli 3-4 hairs, posterior 3-5, 35-42  $\mu$  long. Antennae five-segmented, 542-590  $\mu$  long, 0.41-0.47 times as long as the body, and 1.4-1.5 times the width of the head across the eyes; segment I

brown, somewhat wrinkled, segment II brown, dorsally and ventrally with spinulose imbrications, the spinulae 1-2  $\mu$  long; segments III-V (fig. 188) with ring-shaped secondary rhinaria, the rings are not closed on the dorsal side, the ends usually pass each other along a distance of 2-10  $\mu$ ; between the rhinaria are 2-3 concentric ring-shaped spinulose imbrications, sometimes with interconnections. The rhinaria are 2-4  $\mu$  wide, the spaces 4-10  $\mu$ . The primary rhinaria are wider than the annular rhinaria, and moulded with these to a complex structure; segment III with 24-29 annular rhinaria, IV with 9-12, V with 7-11; segment III longest hair 14-25  $\mu$ . Length of segment III, 275-300  $\mu$ , 2.6-2.8 times as long as IV, 3.1-3.4 times as long as V, and 1.35-1.54 times as long as IV plus V; segment IV, 100-115  $\mu$  long, 1.10-1.49 times as long as V; segment V, 74-94  $\mu$  long. The last rostral segment (fig. 189) is 52-55  $\mu$  long, 0.70-0.75 times as long as the second tarsal segment of the hind leg; length of the stylets 256-278  $\mu$ . Eyes compound.

Thorax.— Prothorax pale brown, with two hairs on each side. Mesonotum dark brown. Fore wing (fig. 190) medial vein once branched, the hind wing with two oblique veins. Legs brown, the basal half of the femora slightly paler; femora smooth; tibia of the fore leg 332-350  $\mu$  long, 0.84-0.91 times as long as the width of the head across the eyes; tibiae at the distal part with spinulose imbrications, most hairs of the hind tibia 20-30  $\mu$  long; chaetotaxy of first tarsal segments 4, 3, 2, the tarsi almost smooth, length of hairs of the hind tarsus 40  $\mu$ , 0.53-0.59 times as long as the second tarsal segment of the hind leg; second tarsal segments with spinulose imbrications, and of the hind leg dorsoapically with two hairs, 35-38  $\mu$  long, expanded at the tips, the tips 3-4  $\mu$  wide; length of the empodial hair of the hind leg 24-27  $\mu$ . Length of hind segments: femur fused with trochanter, 303-324  $\mu$ , tibia 408-423  $\mu$ , 1.30-1.38 times as long as the femur, and 1.02-1.08 times the width of the head across the eyes; first tarsal segment 29-33  $\mu$ , second tarsal segment 73-76  $\mu$ .

Abdomen.— (fig. 191). Segments I-VI colourless, VII with a pale brown marginal spot, VIII pale brown with rather indistinct spinulose imbrications on the anterior part. Number of hairs on tergite I, 7-11; II, 7-8; III, 5-8; IV, 4-8; V between the siphunculi 2-5; VI, 2-3 but usually two; VII, two; VIII, 6-10; length of hairs dorsally on segment IV, 32-38  $\mu$ , ventrally 20-25  $\mu$ , on tergite VIII, 40-45  $\mu$ . Siphunculi located on segment V, pale brown, about 15  $\mu$  high, with a few concentric wrinkles, at the base about 60  $\mu$  wide, with 4-5 hairs, 24-35  $\mu$  long, the pore brown, with a diameter of 27-33  $\mu$ . Cauda (fig. 192) colourless, broadly rounded without a constriction, e.g. 106  $\mu$  wide at the base and 38  $\mu$  long; at the base 103-113  $\mu$  wide, with 9-10 hairs, the longest 53-61  $\mu$ . Subanal plate bilobed, with 17 hairs, the longest 51-67  $\mu$ . Subgenital plate with 5-7 anterior hairs, 27-33  $\mu$  long, and 14-17 posterior hairs, 30-36  $\mu$  long. Gonapophyses two, each with 5-6 hairs, the longest 10-15  $\mu$ . Spiracles on six abdominal segments, II-VII, and on VIII a brown patch without a distinct aperture.

First stage larva of aptera (figs. 193, 194; description of one specimen). Body length 630  $\mu$ . Head fused dorsally with the pronotum, pale brown, the margin anterior to the eyes crenulated, with three transverse rows of four hairs, 35  $\mu$  long; the head ventrally with two horns, 40  $\mu$  long, and 20  $\mu$  wide at the base; lateral to the horns a hair, 58  $\mu$  long with a diameter of the process 7-9  $\mu$  wide; posterolateral to the horns a dagger hair, 18  $\mu$  long, four  $\mu$  wide near the base, with a diameter of the process of 12  $\mu$ ; posterior to the dagger hairs, two hairs on each side with a diameter of the process of 4-5  $\mu$ . Antennae pale brown, 244  $\mu$  long, 0.94 times as long as the dis-

tance between the outer margins of the eyes, with four segments, III and IV with spinulose imbrications, III, 96  $\mu$  long, 0.37 times as long as the distance between the outer margins of the eyes. Eyes brown, with three ommatidia and lumps in between, distance between the outer margins of the eyes 259  $\mu$ .

On each side of the prothorax marginally 10 wax glands, the pronotum with two hairs. The mesothorax with 13-16 wax glands on each side, dorsally with four hairs, the metathorax with 10-11 wax glands on each side and dorsally with four hairs. Legs pale brown, the tibiae with spinulose imbrications, the length of the fore tibia 152  $\mu$  long, 0.59 times as long as the distance between the outer margins of the eyes; the hind tibia distally with a sturdy hair, 45  $\mu$  long, and one spine, 12  $\mu$  long, and three  $\mu$  wide near the base.

Abdominal segments I-VII each with a marginal, very pale brown sclerite with 6-8 wax glands, hairs of the tergites acute, 15-20  $\mu$  long. Abdominal segment VIII with 14 wax glands along the posterior margin, with two hairs, 28  $\mu$  long. Siphunculi are lacking.

Embryos in alatae are similar to those of apterae.

Host records.— Specimens were collected in Java, the collectors are indicated between parantheses: P. van der Goot or Van der Goot (1917) (1), partly in the collection at the Laboratorium voor Entomologie, Wageningen; Liem S.L. (2) and F.W. Rappard (3) and P. Büchner (4) in the collection at the British Museum (Natural History), London; and D. Noordam (5) in the collection at the Rijksmuseum van Natuurlijke Historie, Leiden. *Freycinetia* spec., Lawang, xii.1912 (on slides 1913), Bogor, xii. 1914 (1); *Freycinetia funicularis*, Buitenzorg, 2.ix.1949 (2); *Pothos longifolius*, Sempolan-Djember (500 m), 10.ii.1950 (3); *Freycinetia gaudichaudii* Benn., Gondang, 13.viii.1950 (3); *Freycinetia*, Bogor, 1.vi.-30.vii.1956, B65 (4); *Freycinetia funicularis* (Savigny) Merr., Bogor, Kebun Raya, 7.vi.1975, 25.xii.1976 (5).

The aphids live on the youngest leaves of the plant. Larvae of alatae were collected xii.1912.

Etymology.— *Freycinetia*, of *Freycinetia*, a genus of the Pandanaceae.

***Cerataphis lataniae* (Boisduval, 1867)**  
(figs. 195-206)

*Coccus lataniae* Boisduval, 1867: 355.

*Cerataphis lataniae*; Eastop & Hille Ris Lambers, 1976: 130.

*Aphis palmae* Baehr, 1920: 318; Eastop & Hille Ris Lambers, 1976: 130 (synonymy).

Apterous viviparous female.— In life (pl. 21): Body shiny brown or orange-brown, segments observable by a slight reflection of the vaulting of each segment. Siphunculi same colour as the body. Eyes black. A flat, horizontal white fringe of wax along the border of the body, almost without any interruption. Smallest larvae yellow with a paler longitudinal line from head to abdomen with a narrow wax fringe which is lacking at the front of the head.

Macerated specimens.— (figs. 195-197; described from nine specimens): Body oval, 0.86-1.32 mm long, and 560-980  $\mu$  wide, 1.3-1.5 times as long as it is wide, the dorsum wholly brown or pale brown sclerotic, margins crenulated, interrupted by a

transverse furrow between metanotum and abdominal tergite I, and by the free abdominal tergite VIII.

Head.— Head fused with all thoracic tergites, dorsally almost smooth, densely with dots of less than one  $\mu$ . Marginally, from the posterior sides of the metathorax a row of 95-100 wax glands without interruptions passing ventrally to the eyes, and dorsally to the base of the antennae; four frontal wax glands are slightly raised compared to the adjacent glands; length of the dorsal frontal hairs 5-12  $\mu$ . Ventrally to the frontal wax glands are two horns (fig. 196), smooth, acute, and without hairs, 35-75  $\mu$  long, 0.11-0.18 times as long as the distance between the outer margins of the eyes. Posterolateral to the horns are four hairs on each side, diameter of the process of these hairs from the anterior to the posterior side e.g. 6, 6, 7 and 5  $\mu$ , all hairs slender, the longest 37-59  $\mu$ . Antennae pale brown, 177-250  $\mu$  long, 0.17-0.21 times as long as the body, 0.49-0.61 times the distance between the outer margins of the eyes, with four or five segments, segment III smooth, the last segment, and in five-segmented antennae segment IV, with some spinulose imbrications; hairs on III, 11-16  $\mu$  long. Length of segments in four-segmented antennae: III, 65-103  $\mu$ ; IV, 59-81  $\mu$ ; III is 1.1-1.6 times as long as IV; in five-segmented antennae length of III, 48-65  $\mu$ ; IV, 39-49  $\mu$ ; V, 64-81  $\mu$ ; III is 1.0-1.6 times as long as IV, 0.68-0.86 times as long as V, IV is 0.51-0.73 times as long as V, and III plus IV is 1.3-1.5 times as long as V. Ultimate rostral segment 43-53  $\mu$  long, 0.71-0.85 times the length of the second tarsal segment of the hind leg, without accessory hairs; stylets 280-350  $\mu$  long. Eyes situated dorsally, the distance between the outer margins 306-458  $\mu$ , brown, with three ommatidia. The head is fused dorsally with the three thoracic segments, the borders of which are mainly observable by the presence of six slightly darker coloured, sunken intermuscular plates; three transverse rows of hairs dorsally on the head.

The pronotum bears 4-6 hairs, the mesonotum 7-9, and the metanotum 7-9. Legs pale brown, smooth, also the tarsi. Tibia of the fore leg 118-146  $\mu$  long, 0.29-0.35 times as long as the distance between the outer margins of the eyes. Chaetotaxy of first tarsal segments 4, 3, 2 hairs, the hairs of the hind leg usually expanded at the tip, 37-59  $\mu$  long, 0.58-0.72 times as long as the second tarsal segment of the hind leg; the second tarsal segment of the hind leg apically usually with four hairs expanded at the tips, the longest 33-45  $\mu$ ; empodial hairs 20-25  $\mu$  long. Length of segments of hind leg: femur plus trochanter 152-200  $\mu$ , tibia 177-204  $\mu$ , 1.01-1.16 times as long as the femur, first tarsal segment 27-30  $\mu$ , second tarsal segment 53-68  $\mu$ .

Abdomen.— Segments I-VII fused, dorsally with indistinct furrows between the segments, with intersegmental muscle plates, marginally crenulated by, on each side, 32-40 wax glands; the glands rectangular with rounded corners, e.g. 31  $\mu$  long, 14  $\mu$  wide; dorsal to the glands on each side on each segment one marginal hair, and ventrally on segment V, 1-3 marginal hairs, on VI, 1-3; and on VII, 1-4; tergite I with 6-8 hairs, II, 4-7; III, 5-6; IV, 4-5; V, 3-6; VI, 3-6; VII two; length of hairs on tergite IV, 4-7  $\mu$ , ventrally on IV, 12-21  $\mu$ . Siphunculi situated dorsally, about 70-100  $\mu$  away from the margin of the body, the pore brown, 20-30  $\mu$  diameter, around the pore the pale brown slightly darker than the surrounding area, but without a distinct border (in larvae the hairs are located at the border of the siphunculi), with 1-4 hairs at a distance of about 10-35  $\mu$  from the margin of the pore. Abdominal segment VIII dorsally free, transversely elongate, e.g. 67  $\mu$  long, 225  $\mu$  wide, the posterior margin with 14-16 wax glands, without any interval, with 6-10 hairs, of which two spinal; dorsal to



the wax glands, 12-22  $\mu$  long, the other hairs lateral, ventral to the wax glands, the longest 27-49  $\mu$ . Cauda (fig. 197) distinctly knobbed, e.g. at the base 90  $\mu$  wide, diameter of the constriction 40  $\mu$ , the knob 35  $\mu$  long and 80  $\mu$  wide; the knob 60-90  $\mu$  wide, with 12-15 hairs, the longest 57-80  $\mu$ . Subanal plate bilobed, with 16-18 hairs, the longest 67-90  $\mu$ . Subgenital plate with 4-6 anterior hairs, 22-33  $\mu$  long, and 12-21 posterior hairs, 23-55  $\mu$  long. Gonapophyses two, each with 4-5 hairs, the longest 10  $\mu$  long.

Alate viviparous.— In life: Dark (F.W. Rappard, unpublished).

Macerated specimens.— (figs. 198-203; described from four specimens): Body length 1.4-1.5 mm, 1.9-2.1 times as long as it is wide.

Head.— (fig. 198). Head smooth, brown, width across the eyes 410-435  $\mu$ , the frons ventrally with normal thin hairs, dorsal to the median ocellus, and anterior to the paired ocelli 6-7 hairs, posterior to the paired ocelli 4-5 hairs, 12-16  $\mu$  long. Antennae five-segmented, 690-720  $\mu$  long, 0.47-0.50 times as long as the body, and 1.6-1.8 times the width of the head across the eyes; segment I brown, somewhat wrinkled, segment II brown, dorsally and ventrally with wrinkles and a few spinulae; segments III-V (fig. 199) with ring-shaped secondary rhinaria, the rings are not closed on the dorsal side, with a space of 2-25  $\mu$ , seldom do the ends pass each other; between the rhinaria 2-3, or many more concentric ring-shaped spinulose imbrications, especially dorsally with several interconnections. The rhinaria are 2-4  $\mu$  wide, the spaces 6-10  $\mu$ , but on the distal segments frequently more. The primary rhinaria are wider than the annular rhinaria, on segment IV moulded with these to a complex structure, but on segment V separate and distally located; segment III with 25-34 annular rhinaria, IV with 7-11, V with 2-8; longest hair on segment III, 10  $\mu$ . Length of segment III, 345-370  $\mu$ , 2.5-3.0 times as long as IV, 2.5-3.0 times as V, and 1.25-1.42 times as IV plus V; segment IV, 125-140  $\mu$  long, 0.89-1.08 times as long as V; segment V, 125-140  $\mu$  long. The last rostral segment (fig. 200) is 61-68  $\mu$  long, 0.75-0.89 times as long as the second tarsal segment of the hind leg; length of the stylets 312-315  $\mu$  long. Eyes compound.

Thorax.— Prothorax pale brown, with two hairs on each side. Mesonotum dark brown. Fore wing (fig. 201) medial vein once branched, the hind wing with two oblique veins. Legs brown, the dorsal side of femora and tibiae darker; tibia of the fore leg 280-300  $\mu$  long, 0.67-0.73 times as long as the width of the head across the eyes, the tibiae without spinulae, most hairs of the hind tibia 20-30  $\mu$  long; chaetotaxy of the first tarsal segments 4, 3, 2, the first tarsal segments, smooth, length of hairs of the hind tarsus 40-41  $\mu$ , 0.49 times as long as the second tarsal segment of the hind leg; second tarsal segments with spinulose imbrications, and of the hind leg dorsoapically with two hairs, 45  $\mu$  long, expanded at the tips, the tip four  $\mu$  wide; length of the empodial hair of the hind leg, 29-31  $\mu$ . Length of hind segments: femur plus trochanter 308-320  $\mu$ , tibia 377-385  $\mu$ , 1.20-1.22 times as long as the femur, and 0.88-0.89 times the width of the head across the eyes; first tarsal segment 36-39  $\mu$ , second tarsal segment 76-83  $\mu$ .

Abdomen.— (fig. 202). Segments I-V colourless, VI and VII with a very pale brown marginal sclerite with a diameter of 20-60  $\mu$ ; tergite VIII pale brown with indistinct spinulose imbrications. Number of hairs on tergite I about seven; II, 5-6; III, five; IV, 4-5; V between the siphunculi 4-5; VI, 2-4; VII two; VIII four; length of hairs dorsally on IV, 12-16  $\mu$ , ventrally 22-25  $\mu$ , on tergite VIII, 23-27  $\mu$ . Siphunculi located on segment V, pale brown, about 10  $\mu$  high, almost smooth, at the base about 80  $\mu$

wide, with 2-4 hairs, 14-16  $\mu$  long, the pore brown, with a diameter of 28-33  $\mu$ . Cauda (fig. 203) colourless, with a knob and a constriction, e.g. 110  $\mu$  wide at the base, diameter of the constriction 43  $\mu$ , the knob 40  $\mu$  long and 83  $\mu$  wide; the knob 73-83  $\mu$  wide, with 16-18 hairs, the longest 50-55  $\mu$ . Subanal plate bilobed, with 23 hairs, the longest 63-65  $\mu$ . Subgenital plate with 6-7 anterior hairs, 29-38  $\mu$  long, and 17-20 posterior hairs, 43-47  $\mu$  long. Gonapophyses two, each with 5-6 hairs, the longest 13-16  $\mu$ . Spiracles on six abdominal segments, and on VIII a brown patch without a distinct aperture.

First stage larva of aptera (figs. 204, 205). Body length 490  $\mu$  up to, in specimens almost moulting, 710  $\mu$ . Head fused dorsally with the pronotum, pale brown, the margin anterior to the eyes crenulated, with three rows of four hairs, the middle frontal curved, 14-24  $\mu$  long; head ventrally anterior to the rostrum pale brown with two horns (fig. 205) and laterally with two hairs on each side, the anterior of these 51-63  $\mu$  long on a distinctly sclerotic process, with a diameter at the base of 8-10  $\mu$ , the posterior hairs always smaller, 41-57  $\mu$  long with a diameter of the process of six  $\mu$ . Antennae pale brown, 185-224  $\mu$  long, 0.88-1.02 times as long as the distance between the outer margins of the eyes, with four segments, III and IV with spinulose imbrications, III, 59-74  $\mu$  long, 0.27-0.32 times as long as the distance between the outer margins of the eyes. Eyes brown, with three ommatidia, and about eight lumps in between; distance between the outer margins of the eyes 192-244  $\mu$ . Prothorax on each side marginally 10-13 wax glands, and dorsal to these two hairs, pronotum with two hairs. The mesothorax on each side marginally 12-16 wax glands, the metathorax with 8-11. Legs pale brown, the tibiae on the ventral side with spinulose imbrications, length of fore tibia 96-131  $\mu$ , 0.50-0.62 times as long as the distance between the outer margins of the eyes. All first tarsal segments with two hairs, second tarsal segments with spinulose imbrications. Abdominal segments I-VII each with a marginal very pale brown sclerite with 4-7 wax glands, hairs of tergites acute or blunt, 4-18  $\mu$  long. Abdominal segment VIII with 14-16 wax glands along the posterior margin. Siphunculi are lacking.

Second stage larva of aptera (fig. 206) the head ventrally almost as in first stage larvae. In later stages the antennae and fore tibiae do not change in length. Embryos in alatae with horns and marginal wax glands like first stage larvae of apterae.

Host plant records.— All collections in Java are from *Cocos nucifera* L.: Banjoe-wangi, 2.viii.1948, F.W. Rappard, in the collection at the British Museum (Natural History), London; Bogor, 16.xii.1977, and 17.i.1978; Lawang (500 m), 27.xii.1977; Cipanas-Garut (800 m), 5.ii.1978, the last four D. Noordam, in the collection at the Rijksmuseum van Natuurlijke Historie, Leiden.

Alatae were collected by Dr F.W. Rappard 2.viii.1948.

The apterae live on the lower side of leaves.

Etymology.— *Lataniae*, of *Latania*, a genus of Palmae, name given by Boissduval (1867).

### ***Cerataphis orchidearum* (Westwood, 1879)**

(figs. 207-218)

*Asterolecanium orchidearum* Westwood, 1879: 797.

*Cerataphis lataniae*; Van der Goot, 1915: 435; 1917: 171 (as *C. latanae*).

*Cerataphis orchidearum*; Eastop & Hille Ris Lambers, 1976: 130 (synonymy).

Apterous viviparous female.— In life: Body blackish brown. Eyes black. Antennae grey with darker distal end. Legs pale brown, the tarsi and knees darker. The body round with a fringe of wax, Van der Goot, 1915: 435.

Macerated specimens.— (figs. 207-209; described from five specimens, some of these not from Java): Body oval 1.40-1.88 mm long, and 870-1340  $\mu$  wide, 1.3-1.6 times as long as it is wide, the dorsum wholly brown sclerotic, margins crenulated, interrupted by a transverse furrow between metanotum and abdominal tergite I, and by the free abdominal tergite VIII.

Head.— Head fused with all thoracic tergites, the borders dorsally somewhat wrinkled and lumpy, the surface with dots of less than one  $\mu$  arranged in a network pattern. Marginally, from the posterior sides of the metathorax a row of 92-106 wax glands without interruptions passing ventrally to the eyes, and dorsally to the base of the antennae; four frontal wax glands are slightly raised compared with the adjacent glands; length of the dorsal frontal hair 14-20  $\mu$ . Ventral to the frontal wax glands are two horns, smooth, acute, without hairs, 28-93  $\mu$  long, 0.07-0.17 times as long as the distance between the outer margins of the eyes. Lateral and posterior to the horns are four hairs on each side, diameter of the process of these hairs backwards e.g. 8, 8, 10, and 6  $\mu$ , all hairs slender, the length of these from the anterior to the posterior side 37-40  $\mu$ , 29-37  $\mu$ , 50-62  $\mu$ , and 29-33  $\mu$  respectively. Antennae brown, 300-375  $\mu$  long, 0.20-0.23 times as long as the body, 0.64-0.74 times the distance between the outer margins of the eyes, with five segments, I-III almost smooth, IV and V with spinulose imbrications; length of III, 71-120  $\mu$ , the hairs 14-16  $\mu$  long; IV, 40-60  $\mu$ ; V, 96-103  $\mu$ ; III is 1.6-2.2 times as long as IV, 0.7-1.2 times as long as V, IV is 0.42-0.60 times as long as V, and III plus IV is 1.1-1.8 times as long as V. Ultimate rostral segment 68-106  $\mu$  long, 0.9-1.1 times the length of the second tarsal segment of the hind leg, without accessory hairs; stylets 520-700  $\mu$  long. Eyes situated dorsally or marginally, the distance between the outer margins 415-555  $\mu$ , with three ommatidia.

The head is fused dorsally with the three thoracic segments, the borders of which are observable by the presence of six somewhat sunken intermuscular plates; three transverse rows of hairs are situated dorsally on the head, the pronotum bears 6-7 hairs, the mesonotum 6-8, and the metanotum 7-10. Legs brown, smooth, also the tarsi. Tibia of the fore leg 181-220  $\mu$  long, 0.37-0.44 times as long as the distance between the outer margins of the eyes. Chaetotaxy of first tarsal segments 4, 3, 2 hairs, the hairs of the hind leg not expanded at the tips, 41-49  $\mu$  long, 0.52-0.63 times as long as the second tarsal segment of the hind leg; the second tarsal segment of the hind leg with the two dorsoapical hairs 43-49  $\mu$  long, expanded at the tips, the tip about four  $\mu$  wide; empodial hairs 27  $\mu$  long. Length of segments of hind leg: femur plus trochanter 247-268  $\mu$ , tibia 263-269  $\mu$ , 0.98-1.06 times as long as the femur, first tarsal segment 33-35  $\mu$ , and second tarsal segment 76-96  $\mu$ .

Abdomen.— Segments I-VII fused, dorsally with indistinct furrows between the segments, with intersegmental muscle plates, marginally crenulated by on each side 41-48 wax glands; the glands rectangular with rounded corners, e.g. 29  $\mu$  long, 18  $\mu$  wide; dorsal to the glands on each side on each segment one marginal hair, and ventrally on each of the segments V-VII, usually 2-4 hairs; tergite I with 10 hairs, II, 10-11; III, 7-9; IV, 5-8; V four; VI, 2-4; VII two; length of hairs on tergite IV, 14-19  $\mu$ , ventrally on IV, 17-20  $\mu$ . Siphunculi situated dorsally 60-90  $\mu$  away from the margin, about 15  $\mu$  elevated, the cone with some concentric wrinkles, darker brown close to

the pore, fading into the colour of the surroundings, with 3-5 hairs 12-25  $\mu$  long; pore brown 35-43  $\mu$  diameter. Abdominal segment VIII dorsally free, transversely elongate, e.g. 72  $\mu$  long, 300  $\mu$  wide, the posterior margin with 17-19 wax glands, without any space, with 10 hairs, two of which spinal, dorsal to the wax glands, 38-47  $\mu$  long, the other hairs lateral, ventral to the wax glands, the longest 71-76  $\mu$ . Cauda distinctly knobbed, e.g. at the base 98  $\mu$  wide, diameter of the constriction 46  $\mu$ , the knob 31  $\mu$  long and 74  $\mu$  wide; the knob 73-88  $\mu$  wide, with 11-12 hairs, the longest 80-95  $\mu$ . Subanal plate bilobed, with 18-19 hairs, the longest 90-100  $\mu$ . Subgenital plate with 4-5 anterior hairs, 30-41  $\mu$  long, and 18-23 posterior hairs, 41-53  $\mu$  long. Gonapophyses two, each with 4-5 hairs, the longest 10  $\mu$ .

Alate viviparous female.— In life: Head and thorax blackish brown. Abdomen usually dirty dull green, sometimes with a brown tinge. Eyes, antennae, legs black. Pterostigma of the fore wing greyish black (Van der Goot, 1915: 436).

Macerated specimens.— (figs. 210-218; described from 2-6 specimens, not from Java): Body length 1.58-2.00 mm.

Head.— (fig. 210). Head smooth brown, width across the eyes 415-515  $\mu$ , the frons dorsal to the median ocellus with two hairs 23-29  $\mu$  long, dorsal to these and anterior to the paired ocelli five hairs in a transverse row, posterior to the paired ocelli 4-5 hairs, 23-33  $\mu$  long; ventral hairs normal, dagger hairs lacking. Antennae five-segmented, 610-760  $\mu$  long, 0.30-0.45 times as long as the body, and 1.2-1.7 times the width of the head across the eyes; segment I brown, somewhat wrinkled, segment II brown dorsally and ventrally with spinulose imbrications, the spinulae one  $\mu$  long; segments III-V (fig. 211) with ring-shaped secondary rhinaria, the rings are not closed on the dorsal side, with a space of 2-30  $\mu$ ; between the rhinaria are usually three concentric ring-shaped spinulose imbrications, mainly on the dorsal side with interconnections. The rhinaria are 2-4  $\mu$  wide, the spaces 6-10  $\mu$ . The primary rhinaria are between the annular rhinaria, and are moulded with these to a complex structure; segment III with 29-34 annular rhinaria, IV with 10-13, V, 10-14; segment III longest hair 11-22  $\mu$ ; length of segment III, 265-360  $\mu$ , 2.0-2.7 times as long as IV, and 0.91-1.41 times as long as IV plus V; IV, 115-145  $\mu$  long, 0.76-1.19 times as long as V; V, 105-170  $\mu$  long. The last rostral segment (fig. 212) is 83-101  $\mu$  long, 0.94-0.99 times as long as the second tarsal segment of the hind leg, without accessory hairs; length of stylets 375-385  $\mu$ . Eyes compound.

Thorax.— Prothorax pale brown, with two hairs on each side. Mesonotum dark brown. Fore wing medial vein once branched, the hind wing with two oblique veins. Legs brown, the distal part of the femora and the base of the tibiae dorsally slightly darker; femora smooth; tibia of the fore leg (fig. 214) 370-490  $\mu$ , 0.83-0.95 times as long as the width of the head across the eyes, the tibiae smooth with some spinulae on the distal part, most hairs of the hind tibia 30-45  $\mu$  long; chaetotaxy of first tarsal segments (fig. 215) 4, 3, 2, the tarsi almost smooth, length of hairs on the hind tarsus 41  $\mu$ , 0.45-0.47 times as long as the second tarsal segment of the hind leg; second tarsal segments (fig. 216) with spinulose imbrications, and of the hind leg dorsoapically with two hairs, 44-45  $\mu$  long, expanded at the tips, the tips four  $\mu$  wide; length of the empodial hair of the hind leg 27-29  $\mu$ . Length of hind segments: femur fused with the trochanter, 362-373  $\mu$ , tibia 468-480  $\mu$ , 0.88-0.90 times as long as the width of the head across the eyes, first tarsal segments 31-33  $\mu$ , second tarsal segment 88-106  $\mu$ .

Abdomen.— (fig. 217). A transverse band on tergite VIII pale brown, other

marginal and dorsal parts colourless. Number of hairs on tergite III, 10-11; IV, 9-12; V, 4-6; VI, 2-4; VII, two; VIII, 5-8; length of hairs dorsally on segment IV, 25-27  $\mu$ , ventrally on IV, 20-31  $\mu$ , on tergite VIII spinal hairs, 26-43  $\mu$ . Siphunculi located on segment V, colourless, with 3-5 hairs, 29-33  $\mu$  long, the pore yellowish, with a diameter of 33-40  $\mu$ . Cauda (fig. 218) colourless, distinctly knobbed, e.g. the base 114  $\mu$  wide, diameter of the constriction 65  $\mu$ , the knob 40  $\mu$  long and 86  $\mu$  wide; the knob 74-96  $\mu$  wide, with 15-19 hairs, the longest 63-78  $\mu$ . Subanal plate bilobed, with 17-19 hairs, the longest 84-94  $\mu$ . Subgenital plate with 3-6 anterior hairs, 33-35  $\mu$  long, and 17-23 posterior hairs, 41-47  $\mu$  long. Gonapophyses two, each with 4-6 hairs, the longest 12-18  $\mu$ . Spiracles on seven abdominal segments, I-VII, the one on I small.

Host plant records.— Specimens were collected in Java: On *Vanda spec.*, Tangoe-  
langin, Mt. Merbaboe (1300 m), without date, leg. P. van der Goot (Van der Goot  
(1917); *Vanda spec.*, Kali Bendo, Banjoewangi (400 m), 26-9-1948, and *Vanda tricolor*,  
Idjen plateau (1200 m), 12.xi.1949, leg. F.W. Rappard no. 66, 154, in the collection at  
the British Museum (Natural History), London.

The aphids live on the upper and lower sides of leaves of *Vanda*, *Dendrobium*, *Pa-  
phiopedilum* and *Phalaenopsis* species, C.J.H. Franssen and L.M.J. Tiggelovend (1935).

Etymology.— Orchidearum, of orchids, name given by Westwood (1879).

***Cerataphis palmae* (Ghesquière, 1934)**  
(figs. 219-236)

*Aleurocanthus palmae* Ghesquière, 1934: 29.

*Cerataphis variabilis* Hille Ris Lambers, 1953: 95; Eastop & Hille Ris Lambers, 1976: 130 (synonymy).

*Cerataphis palmae*; Eastop & Hille Ris Lambers 1976: 130.

*Cerataphis latanae*; Van der Goot, 1917: 169.

Types.— Paratypes of *Cerataphis variabilis*, apterous, viviparous female, Palma-  
ceae, Bondowoso (300 m), 13.ix.1948, and Kali Bendo, 24.x.1948, leg. F.W. Rappard  
no. 62 and no. 80, in the collection at the British Museum (Natural History), London.

Van der Goot (1917: 169) described one *Cerataphis* species which he collected  
from *Cocos nucifera* and *Areca cathecu* and named *Cerataphis latanae* Boisduv.; the de-  
scription of the apterae mentions that the head bears ventrally on each side a short  
dagger hair. This is characteristic of *C. palmae* (Ghesquière, 1934) while these dagger  
hairs are lacking in *C. latanae* (Boisduval, 1867). The material collected by Van der  
Goot in 1913-1915 is lost, but a slide which he collected 20.viii.1918 from *Nipa* is in  
the collection at the Laboratorium voor Entomologie, Wageningen, bearing the deter-  
mination of P. v.d. Goot "*Cerataphis latanae*", but the specimens show all characteris-  
tics of *C. palmae* which are mentioned here in the key of the apterae. As well as nor-  
mal apterae a second apterous type occurs with short horns, called by Van der Goot  
(1917) Geschwister der Geflügelten. After the description of the first type the distin-  
guishing marks of the second are enumerated.

Apterous viviparous female.— In life (pl. 22): Body blackish brown, usually dull,  
but sometimes shiny, dorsally with a white transverse line between metanotum and  
abdominal segment I, and sometimes also one between abdominal segments I and II  
which ends pleurally; if the dorsal wax cover is damaged some other white patches  
may be seen. Abdominal segment III brown. Eyes black. A flat, horizontal white

fringe of wax along the border of the body, up to 0.35 mm wide, without any interruption on the body, but with several slits at the border. Antennae pale brown, distally darker. Legs pale brown. Larvae yellow or greenish with brown head and pronotum, but the sides of the pronotum same colour as the body, antennae and legs pale brown, without wax or with a narrow wax fringe. Later stages of larvae also brown patches on meso- and metanotum, and whitish transverse lines between the thoracic and abdominal segments.

Macerated specimens.— (figs. 219-221; described from 13 specimens): Body oval, 0.97-1.67 mm long, and 710-1400  $\mu$  wide, 1.1-1.5 times as long as it is wide, the dorsum wholly brown, sclerotic, margins crenulated, interrupted by a transverse furrow between metanotum and abdominal tergite I, and by the free abdominal tergite VIII.

Head.— Head fused with all thoracic tergites, dorsally almost smooth, densely with dots of less than one  $\mu$ . Marginally, from the posterior sides of the metathorax a row of 80-102 (in one specimen 64) wax glands usually without interruptions passing ventral to the eyes, and dorsal to the base of the antennae; four frontal wax glands are slightly raised, but in some specimens one to four of these glands are lacking; length of the dorsal frontal hairs 20-29  $\mu$ . Ventral to the frontal wax glands are two horns (fig. 220), smooth, acute and without hairs, 45-110  $\mu$  long, 0.11-0.20 times as long as the distance between the outer margins of the eyes. Lateral and posterior to the horns are on each side two anterior hairs, one or two in the middle, and two or three posterior hairs: the anterior hairs 40-62  $\mu$  long with the diameter of their processes six  $\mu$ , in some collections with stages intermediate to alatae these hairs are short, dagger-shaped and the diameter of the processes 10-14  $\mu$ ; the middle hair is 10-16  $\mu$  long, sometimes up to 33  $\mu$ , but the base of the hair is wide, 4-6  $\mu$ , and the diameter of the process 12-14  $\mu$ , the other middle hair is normal; the posterior hairs are normal, long, with a diameter of the process 6  $\mu$ . Antennae with four or five segments, brown or pale brown with darker last segment, 200-315  $\mu$  long, 0.18-0.24 times as long as the body, 0.51-0.69 times the distance between the outer margins of the eyes; in four-segmented antennae III smooth and IV with spinulose imbrications, in five-segmented antennae III with some, IV and V with more spinulose imbrications; hairs on III, 20-29  $\mu$  long. Length of segments in four-segmented antennae: III, 77-122  $\mu$ ; IV, 60-86  $\mu$ ; III is 1.2-1.5 times as long as IV. In five-segmented antennae length of III, 71-113  $\mu$ ; IV, 45-60  $\mu$ ; V, 73-85  $\mu$ ; III is 1.4-2.5 times as long as IV, 1.0-1.4 times as long as V; IV is 0.54-0.70 times as long as V, and III plus IV is 1.7-1.9 times as long as V. Ultimate rostral segment 51-73  $\mu$  long, 0.74-0.94 times the length of the second tarsal segment of the hind leg, without accessory hairs; stylets 270-410  $\mu$  long. Eyes situated dorsally, the distance between the outer margins 365-590  $\mu$ , brown, with three ommatidia.

The head is fused dorsally with the three thoracic segments, the borders of which are mainly observable by the presence of six slightly darker coloured, sunken intermuscular plates; there are three transverse rows of hairs dorsally on the head, the pronotum bears 2-5 hairs, the mesonotum 4-6, and the metanotum 4-7. Legs brown, almost smooth, also the tarsi. Tibia of the fore leg 151-200  $\mu$  long, 0.34-0.44 times as long as the distance between the outer margins of the eyes. Chaetotaxy of first tarsal segments 4, 3, 2 hairs, those of the hind leg sometimes expanded at the tips, 37-45  $\mu$  long, 0.52-0.68 times as long as the second tarsus of the hind leg; the second tarsal segment of the hind leg apically with four hairs expanded at the tips, the longest 37-

45  $\mu$ ; empodial hairs 23-27  $\mu$  long. Length of segments of hind leg: femur plus trochanter 204-291  $\mu$ , tibia 224-314  $\mu$ , 1.04-1.12 times as long as the femur, first tarsal segment 28-36  $\mu$ , second tarsal segment 62-82  $\mu$ .

Abdomen.— Segments I-VII fused dorsally, with indistinct furrows between the segments, with intersegmental muscle plates, marginally crenulated by, on each side, 29-51 wax glands; the glands rectangular with rounded corners, e.g. 30  $\mu$  long, 16  $\mu$  wide; dorsally on each side on each segment one marginal hair, and ventrally on segment V, 2-6 marginal hairs; on VI, 2-6; and on VII, 2-5; tergite I with 6-9 hairs, II, 5-9; III, 5-8; IV, 4-8; V, 2-5; VI, 2-5; VII two; length of hairs on tergite IV, 11-39  $\mu$ , ventrally on IV, 18-27  $\mu$ . Siphunculi situated dorsally, about 30-80  $\mu$  away from the margins, the pore brown, 22-45  $\mu$  diameter, around the pore the colour slightly darker than the surroundings, but without a distinct border, with concentric wrinkles, with 1-5 hairs at a distance of about 5-25  $\mu$  from the margin of the pore. Abdominal segment VIII dorsally free, transversely elongate, e.g. 53  $\mu$  long, 228  $\mu$  wide, the posterior margin with 11-17 wax glands, without any space, with 9-15 hairs, two of which spinal; hairs dorsal to the wax glands, 15-43  $\mu$  long, the other hairs lateral, ventral to the wax glands, the longest 49-84  $\mu$ . Cauda (fig. 221) distinctly knobbed e.g. at the base 108  $\mu$  wide, diameter of the constriction 57  $\mu$ , the knob 33  $\mu$  long and 88  $\mu$  wide; the knob 60-100  $\mu$  wide, with 4-8 hairs, the longest 69-84  $\mu$ . Subanal plate bilobed, with 15-19 hairs, the longest 72-84  $\mu$ . Subgenital plate with 4-8 anterior hairs, 25-39  $\mu$  long, and 8-14 posterior hairs, 27-41  $\mu$  long. Gonapophyses two, each with 3-9 hairs, the longest 8-20  $\mu$ .

In populations with, or close to, the alate stage are apterae which keep the sclerotic body but wax glands disappear, horns are smaller or lacking, up to six of the ventral hairs are dagger-shaped, eyes and siphunculi are situated marginally, and antennae have five segments. A description follows here.

Second type apterous viviparous female, specimens from one collection (fig. 222). Frontal horns lacking or up to 18  $\mu$  long. Two dagger hairs are present as in first type apterae but also 2-4 hairs anterior to these are short and thick and located on tubercles with a diameter of 10-14  $\mu$ . The four wax glands dorsal to the location of the horns are lacking; the wax glands medial to the antennae and anterior to the eyes are well or imperfectly developed. Antennae with five segments, 250-290  $\mu$  long, 0.20-0.23 times as long as the body, 0.61-0.68 times the distance between the outer margins of the eyes; segment III, 73-109  $\mu$  long, 1.8-2.2 times as long as IV, 1.1-1.7 times as long as V, and 0.8-0.9 times as long as IV plus V; segment IV, 40-50  $\mu$  long, 0.6-0.8 times as long as V; segment V, 65-71  $\mu$  long. The marginal wax glands of the thoracic segments fully or imperfectly developed. Margins of abdominal segments V-VII less curved than in the first type apterae. Siphunculi usually extending sideways. Marginal wax glands of segments I-II and VI-VII fully or imperfectly developed, of segments III-V usually absent, but on the posterior margin of VIII sometimes fully developed.

Alate viviparous female. In life: Black with dark green reflection on the abdomen (F.W. van Rappard). Pterostigma black (Van der Goot, 1917).

Macerated specimens.— (figs. 223-229; described from nine specimens): Body length 1.33-1.67 mm, 1.7-2.0 times as long as it is wide.

Head (fig. 223).— Head smooth, brown, width across the eyes 375-455  $\mu$ , the head ventral (fig. 224) with normal thin hairs, 25-37  $\mu$  long, but lateral to the median

ocellus, close to the base of the antennae 1-3 small dagger hairs on each side, 8-20  $\mu$  long, and close to the base 2-3  $\mu$  wide, with a larger process than normal hairs; dorsal to the median ocellus, and anterior to the paired ocelli 4-6 hairs, posterior to the paired ocelli 4-5 hairs, 25-40  $\mu$  long. Antennae five-segmented, 570-750  $\mu$  long, 0.41-0.48 times as long as the body, and 1.5-1.8 times the width of the head across the eyes; segment I brown, somewhat wrinkled, segment II brown, dorsally and ventrally with wrinkles and a few spinulae; segments III-V (fig. 225) with ring-shaped secondary rhinaria, the rings are not closed on the dorsal side, with a space of up to 10  $\mu$ , seldom more but sometimes the ends pass each other for a distance of up to 10  $\mu$ ; between the rhinaria 2-5 concentric ring-shaped spinulose imbrications, especially dorsally with several interconnections. The rhinaria are 2-6  $\mu$  wide, the spaces 4-10  $\mu$ , seldom more. The primary rhinaria are wider than the annular rhinaria, on segment IV moulded with these to a complex structure, but on segment V separate and distally located; segment III with 24-39 annular rhinaria, IV with 9-15, V with 5-11; hairs on segment III are lacking. Length of segment III, 295-415  $\mu$ , 2.2-3.0 times as long as IV, 2.9-3.8 times as long as V, and 1.26-1.67 times as long as IV plus V; segment IV, 115-160  $\mu$  long, 1.13-1.32 times as long as V; segment V, 90-125  $\mu$  long. The last rostral segment (fig. 226) is 58-71  $\mu$  long, 0.69-0.83 times as long as the second tarsal segment of the hind leg; length of the stylets 275-378  $\mu$ . Eyes compound.

Thorax.— Prothorax pale brown, with two hairs on each side. Mesonotum dark brown. Fore wing (fig. 227) medial vein once branched, the hind wing with two oblique veins. Legs brown, the dorsal side of femora and tibiae darker; tibia of the fore leg 332-370  $\mu$  long, 0.78-0.90 times as long as the width of the head across the eyes, the distal half of the tibiae with spinulose imbrications, most hairs of the hind tibia 20-27  $\mu$  long; chaetotaxy of the first tarsal segments 4, 3, 2; the first tarsal segments smooth, length of hairs of the hind tarsus 33-45  $\mu$ , 0.41-0.55 times as long as the second tarsal segment of the hind leg; second tarsal segments with some spinulose imbrications, and of the hind leg dorsoapically with two hairs, 38-45  $\mu$  long, expanded at the tips, the tip three  $\mu$  wide; length of the empodial hair of the hind leg 22-27  $\mu$ . Length of hind segments: femur plus trochanter 318-369  $\mu$ , tibia 397-460  $\mu$ , 1.22-1.31 times as long as the femur, and 0.98-1.13 times the width of the head across the eyes; first tarsal segment 30-34  $\mu$ , second tarsal segment 80-86  $\mu$ .

Abdomen.— (fig. 228). Segments I-VI colourless, VII with a very pale brown marginal sclerite with a diameter of about 60  $\mu$ , with a few spinulose imbrications; tergite VIII pale brown with some spinulose imbrications. Number of hairs on tergites I-IV, 7-8; V, 4-6; VI, 3-5; VII two or seldom three; VIII, 4-6; length of hairs dorsally on IV, 25-38  $\mu$ , ventrally 27-31  $\mu$ , on tergite VIII, 28-43  $\mu$ . Siphunculi located on segment V, pale brown, about 10  $\mu$  high, almost smooth, at the base about 90  $\mu$  wide, with 5-7 hairs, 16-30  $\mu$  long, the pore brown, with a diameter of 45-55  $\mu$ . Cauda (fig. 229) colourless, with a knob and a constriction, e.g. 112  $\mu$  wide at the base, diameter of the constriction 50  $\mu$ , the knob 26  $\mu$  long and 71  $\mu$  wide; the knob 65-100  $\mu$  wide, with 4-9 hairs, the longest 47-60  $\mu$ . Subanal plate bilobed, with 11-19 hairs, the longest 43-67  $\mu$ . Subgenital plate with 4-12 anterior hairs, 25-38  $\mu$  long, and 10-16 posterior hairs, 27-40  $\mu$  long. Gonapophyses two, each with 5-9 hairs, the longest 10-20  $\mu$ . Spiracles on six abdominal segments, II-VII, and on VIII a brown patch without a distinct aperture.

First stage larva of aptera (figs. 230-233). Body length 480-675  $\mu$ .



Head fused dorsally with the pronotum, pale brown, the margin anterior to the eyes crenulated, with three transverse rows of four hairs, the middle frontal hairs curved, 14-29  $\mu$  long; head ventrally similar to embryos and first stage larvae from alatae of *Styrax benzoin*: Anterior to the rostrum pale brown, with two horns without hairs and laterally on each side with three hairs: the anterior of these 41-57  $\mu$  long on a process with a diameter of 6-8  $\mu$ , the hair posterior to this 14-40  $\mu$  long, diameter of the process 8-12  $\mu$ , length of the posterior hair 27-47  $\mu$  on a process with diameter 3-6  $\mu$ . Antennae pale brown, 200-236  $\mu$  long, 0.85-1.16 times as long as the distance between the outer margins of the eyes, with four segments, III and IV with spinulose imbrications, III, 65-78  $\mu$  long, 0.27-0.38 times as long as the distance between the outer margins of the eyes, IV, 78-94  $\mu$  long. Eyes brown, with three ommatidia; distance between outer margins of the eyes 173-269  $\mu$ . Prothorax on each side marginally 8-12 wax glands, and dorsal to these two hairs, pronotum with two hairs. The mesothorax on each side marginally 11-14 wax glands, the metathorax with 8-11. Legs pale brown, the tibiae on the ventral side with spinulose imbrications, length of fore tibia 118-157  $\mu$ , 0.53-0.70 times as long as the distance between the outer margins of the eyes. All first tarsal segments with two hairs, second tarsal segments with spinulose imbrications. Abdominal segments I-VII each with a marginal very pale brown sclerite with 4-7 wax glands, hairs of tergites acute or blunt, 7-18  $\mu$  long. Abdominal segment VIII with 12-16 wax glands along the posterior margin. Siphunculi are lacking.

Embryos from alate viviparous females are of two types: 1. Similar to first stage larvae of apterous viviparous females, with horns, marginal wax gland groups, dorsal blunt hairs, 8-12  $\mu$  long, and a last rostral segment about 50  $\mu$  long; 2. Embryos (figs. 234-236) without horns and marginal wax glands and with hairs dorsally on head, thorax and abdomen, 40-55  $\mu$  long, close to the process 3-4  $\mu$  wide, tapering to the end, but the tip usually a head, 1-3  $\mu$  wide. The last rostral segment 82-88  $\mu$  long, the distal half narrow sometimes even cylindrical.

Host plant records.— Specimens were collected in Java from the following host plants in the places and on the dates indicated, while collectors are indicated by numbers between parentheses: Van der Goot or Van der Goot (1917), (1) in the collection at the Laboratorium voor Entomologie, Wageningen, or lost; C. Franssen (2) in het collection at the Laboratorium voor Entomologie, Wageningen; F.W. Rappard (3), in the collection at the British Museum (Natural History), London; and D. Noordam (4), in the collection at the Rijksmuseum van Natuurlijke Historie, Leiden. *Salacca edulis* Reinw., *Kentia* spec., *Cocos nucifera* L. *Areca cathecu* L., Salatiga, Simo, Soekamangli, 1913-1915 (1); *Nipa*, Bogor, 27.viii.1918 (1); *Cocos nucifera* L., Bogor, 27.xii.1931 (2); *Palmae*, Bondowoso (300 m), 13.ix.1948 (3); *Palmae*, Kali Bendo (400 m), 24.x.1948 (3); *Palmae*, Kalibendo (450 m), 29.xi.1948; *Arenga pinnata* (Wurmb) Merr., Rayap (500 m), 14.v.1950; *Cocos nucifera* L., Bogor, 9.xi.1975, 15.iii.1976 (4); Sindanglaya (1100 m), 2.vi.1976 (4); Bogor 23.xii.1976 (4); *Metroxylon sagu* Rottb., Bogor, Kebun Raya, 18.vii.1977 (4); *Cocos nucifera* L., Sindanglaya (1100 m), 14.xi.1977, 20.xii.1977 (4); *Cocos nucifera* L., Purwodadi, Hortus botanicus, 26.xii.1977 (4); *Cocos nucifera* L., Lawang (500 m), 27.xii.1977 (4); *Cocos nucifera* L., Sindanglaya, (1100 m), 17.i.1978 (4).

Alatae were observed by Van der Goot (1917) early in July 1914, and early in April 1915, and by Dr F.W. Rappard 13.ix.1948, 24.x.1948, and 29.xi.1948.

Apterae live on the lower side of leaves, the larvae can frequently be seen walking around but the adults only occasionally.

Etymology.— *Palmae*, of palm-tree.

Discussion.— In the discussion on *Cerataphis fransseni* it is stated that first stage larvae born from alatae of *Styrax* galls are similar to first stage larvae of apterae of *Cerataphis palmae*. It may be assumed that the embryos of alatae from two collections of *C. palmae* (collection F.W. Rappard no. 62, 13.ix.1948 and no. 80, 24.x.1948) belong to *Styrax*, but I think that the arguments are too scanty to consider *C. fransseni* a synonym of *C. palmae*.

***Cerataphis pothophila* spec. nov.**  
(figs. 237-244)

Types.— Holotype (apterous viviparous female) from *Pothos roxburghii* de Vriese, Bogor Keb. R., Indonesia, 10.x.1976, no. 782-1-3, leg. D. Noordam. Paratypes: 98 apterae viviparae, and 12 alatae viviparae, same locality, same host plant, dates 10.x.1976 and 25.xii.1976, no. 782 and 845, leg. D. Noordam. Holotype and paratypes in the collection at the Rijksmuseum van Natuurlijke Historie, Leiden.

Apterous viviparous female.— In life (pl. 23): Body brownish black, dull, covered with a thin layer of small wax hairs, a white transverse line in the middle. Eyes black. Siphunculi same colour as the body. A flat horizontal white fringe of wax along the border of the body, up to 0.25 mm wide, without any interruption on the body, or a narrow one at the transverse line, with several slits at the border. Larvae orange, later stages brown, dusty, with a longitudinal white band from head to the end of the body, and a narrow wax fringe; antennae and legs pale brown.

Macerated specimens.— (fig. 237; described from 10 specimens): Body oval, 1.35-1.55 mm long, and 960-1170  $\mu$  wide, 1.3-1.5 times as long as it is wide, the dorsum wholly brown, sclerotic, margins crenulated, interrupted by a transverse furrow between metanotum and abdominal tergite I, and by the free abdominal tergite VIII.

Head.— Head fused with all thoracic tergites, dorsally almost smooth, densely with dots of less than one  $\mu$ . Marginally, from the posterior sides of the metathorax a row of 86-102 wax glands passing ventrally to the eyes, and dorsally to the base of the antennae; 2-4 frontal wax glands are slightly raised; length of the dorsal frontal hairs 16-23  $\mu$ . Ventral to the frontal wax glands are two horns, smooth, acute and without hairs, 60-75  $\mu$  long, 0.12-0.16 times as long as the distance between the outer margins of the eyes, the horns more slender and the base of the horns narrower than in *C. palmae*; Lateral and posterior to the horns, on each side, are four hairs, all slender, the longest 45-55  $\mu$ ; diameter of the processes of the three more anterior hairs 6-7  $\mu$ , of the posterior hair 1-2  $\mu$  less. Antennae with four or five segments, brown or pale brown, the last segment darker towards the end, 310-390  $\mu$  long, 0.21-0.26 times as long as the body, 0.66-0.86 times the distance between the outer margins of the eyes; in four-segmented antennae III smooth, distally with spinulose imbrications, IV with spinulose imbrications; in five-segmented antennae III distally with some spinulose imbrications, IV and V with spinulose imbrications; hairs on III, 16-23  $\mu$  long. Length of segments in four-segmented antennae: III, 131-153  $\mu$ ; IV, 91-116  $\mu$ ; III, 1.1-1.6 times as long as IV. In five-segmented antennae length of III, 78-105  $\mu$ ; IV, 34-70  $\mu$ ; V, 91-125  $\mu$ ;

III is 1.2-1.5 times as long as IV, 0.8-1.0 times as long as V, IV is 0.37-0.68 times as long as V, and III plus IV is 1.3-1.7 times as long as V. Ultimate rostral segment 50-59  $\mu$  long, 0.57-0.65 times the length of the second tarsal segment of the hind leg, without accessory hairs; stylets 310-350  $\mu$  long. Eyes situated dorsally, the distance between the outer margins 400-485  $\mu$ , brown with three ommatidia.

The head is fused dorsally with the three thoracic segments, the borders of which are mainly observable by the presence of six slightly darker coloured, sunken intermuscular plates, three transverse rows of hairs are dorsally on the head; the pronotum bears 4-6 hairs, the mesonotum 7-12, and the metanotum 8-9. Legs brown, almost smooth, also the tarsi. Tibia of the fore leg 166-190  $\mu$  long, 0.36-0.44 times as long as the distance between the outer margins of the eyes. Chaetotaxy of first tarsal segments 4, 3, 2 hairs, or exceptionally 4, 3, 3; those of hind leg expanded at the tips, and 0.44-0.54 times as long as the second tarsus of the hind leg; the second tarsus of the hind leg apically with four hairs expanded at the tips, the longest 43-47  $\mu$ ; empodial hairs 25-31  $\mu$  long. Length of segments of hind leg: femur plus trochanter 250-283  $\mu$ , tibia 263-314  $\mu$ , first tarsal segment 33-39  $\mu$ , second tarsal segment 86-101  $\mu$ ; the tibia 1.03-1.12 times as long as the femur.

Abdomen.— Segments I-VII fused dorsally, with indistinct furrows between the segments, with intersegmental muscle plates, marginally crenulated by, on each side, 39-46 (one specimen 29) wax glands; the glands rectangular with rounded corners, e.g. 27  $\mu$  long, 18  $\mu$  wide; dorsally, on each side on each segment, one marginal hair, and ventrally on segment V, 1-6 marginal hairs, on VI, 2-4, and on VII, 1-4; tergite I with 8-10 hairs, II, 5-8; III, 5-7; IV four; V, 4-5; VI, 3-4; VII two; length of hairs on tergite IV, 17-22  $\mu$ , ventrally on IV, 18-22. Siphunculi situated dorsally, about 70-100  $\mu$  away from the margin of the abdomen, cone-shaped, about 25  $\mu$  high, the base without distinct border, but the cone with concentric wrinkles, not darker than the surroundings, and with 2-5 hairs, 12-20  $\mu$  long, pore brown with a diameter of 38-48  $\mu$ . Abdominal segment VIII dorsally free, transversely elongate, e.g. 65  $\mu$  long, 293  $\mu$  wide, the posterior margin with 15-18 wax glands, without any interval, with 8-10 hairs, two of which spinal, dorsal to the wax glands 27-40  $\mu$  long, the other hairs lateral, ventral to the wax glands, the longest 34-43  $\mu$ . Cauda distinctly knobbed, e.g. at the base 102  $\mu$  wide, diameter of the constriction 35  $\mu$ , the knob 33  $\mu$  long and 84  $\mu$  wide; the knob 60-86  $\mu$  wide, with 11-14 hairs, the longest 80-100  $\mu$ . Subanal plate bilobed, with 14-18 hairs, the longest 92-108  $\mu$ . Subgenital plate with 4-5 anterior hairs, 25-41  $\mu$  long, and 11-15 posterior hairs, 33-41  $\mu$  long. Gonapophyses two, each with 4-6 hairs, the longest 10-20  $\mu$ .

Apterae with disappearance of wax glands and horns were not seen.

Alate viviparous female.— In life: Head, antennae and eyes black, thorax and abdomen dirty brown with some green, legs paler brown. Base of the wings bright brown, pterostigma dirty greenish brown. Larvae brown with a narrow wax fringe and a distinct longitudinal band dorsally on thorax and abdomen.

Macerated specimens.— (figs. 238-244; described from nine specimens): Body length 1.40-1.70 mm.

Head.— (fig. 238). Head smooth, brown, width across the eyes 430-465  $\mu$ , the frons ventrally with normal thin hairs; dorsal to the median ocellus with two curved hairs 16-23  $\mu$  long, dorsal to these, anterior to the paired ocelli four hairs in a transverse row, posterior to the paired ocelli 4-6 hairs 23-33  $\mu$  long. Antennae five-seg-

mented, 960-1040  $\mu$  long, 0.61-0.66 times as long as the body, and 1.7-2.3 times the width of the head across the eyes; segment I brown, somewhat wrinkled, segment II brown, dorsally and even more ventrally with spinulose imbrications, the spinulae one  $\mu$  long; segments III-V (fig. 239) with ring-shaped secondary rhinaria, the rings are not closed on the dorsal side, with a space of 4-20  $\mu$ ; between the rhinaria are usually three concentric ring-shaped spinulose imbrications, mainly on the dorsal side with interconnections. The rhinaria are 2-6  $\mu$  wide, the spaces 7-12  $\mu$ . The primary rhinaria are between the annular rhinaria, and are moulded with these to a complex structure; segment III with 28-40 annular rhinaria, IV with 15-20, V with 15-24; segment III longest hair 10-18  $\mu$ . Length of segment III, 400-460  $\mu$ ; IV, 185-220  $\mu$ ; V, 210-280  $\mu$ ; segment III is 2.0-2.3 times as long as IV, 1.6-2.0 times as long as V, and 0.91-1.02 times as long as IV plus V; segment IV is 0.75-0.95 times as long as V. The last rostral segment (fig. 240) is 65-76  $\mu$  long, 0.66-0.75 times as long as the second tarsal segment of the hind leg, without accessory hairs; length of the stylets 300-330  $\mu$ . Eyes compound.

Thorax.— Prothorax margins pale brown, with two hairs on each side. Mesonotum dark brown. Fore wing (fig. 241) medial vein once branched, the hind wing with two oblique veins. Legs brown, the distal part of the femora, and the base of the tibiae dorsally slightly darker; femora smooth; tibia of the fore leg 380-408  $\mu$  long, 0.85-0.91 times as long as the width of the head across the eyes; tibiae smooth with some spinulae on the distal part, most hairs of the hind tibia 18-22  $\mu$  long, the longest distally, about 25  $\mu$ ; chaetotaxy of first tarsal segments 4, 3, 2 or sometimes 4, 3, 3, the tarsi almost smooth, length of hairs of the hind tarsus 40-51  $\mu$ , 0.40-0.49 times as long as the second tarsus of the hind leg; second tarsal segments (fig. 242) with spinulose imbrications, and of hind leg dorsoapically with two hairs, 43-49  $\mu$  long, expanded at the tips, the tips three  $\mu$  wide; length of the empodial hair of the hind leg 23-33  $\mu$ . Length of hind segments: femur fused with trochanter 362-393  $\mu$ , tibia 460-488  $\mu$ , 1.23-1.31 times as long as the femur, and 0.99-1.11 times the width of the head across the eyes; first tarsal segment 33-39  $\mu$ , second tarsal segment 98-106  $\mu$ .

Abdomen.— (fig. 243). A small marginal spot on segment VII sometimes, and a transverse band on VIII pale brown and with spinulose imbrications, other marginal and dorsal parts colourless. Number of hairs on tergite V, 4-5; VI, 3-5; VII, 3-4; and VIII, 4-7; length of hairs dorsally on segment IV, 16-22  $\mu$ , ventrally on IV, 17-25  $\mu$ ; on tergite VIII spinal hairs 23-31  $\mu$ , lateral hairs 29-35  $\mu$ . Siphunculi located on segment V, pale brown, about 15  $\mu$  high, with concentric wrinkles, at the base about 80  $\mu$  wide, with 3-4 hairs, the longest 18-23  $\mu$ , the pore brown, with a diameter of 48-53  $\mu$ . Cauda (fig. 244) colourless, distinctly knobbed, e.g. the base 118  $\mu$  wide, diameter of the constriction 43  $\mu$ , the knob 29  $\mu$  long and 67  $\mu$  wide; the knob 58-76  $\mu$  wide, with 11-14 hairs, the longest 41-54  $\mu$ . Subanal plate bilobed, with 14-17 hairs, the longest 49-55  $\mu$ . Subgenital plate with 3-5 anterior hairs, 25-35  $\mu$  long, and 12-16 posterior hairs, 29-35  $\mu$  long. Gonapophyses two, each with 5-7 hairs, the longest 10-16  $\mu$ . Spiracles on seven abdominal segments, II-VIII.

First stage larva of aptera. Body length 590-675  $\mu$ . Head fused dorsally with the pronotum, pale brown, the margin anterior to the eyes smooth or somewhat crenulated, with three transverse rows of four hairs, the middle frontal hairs curved, 14-20  $\mu$  long; head ventrally anterior to the rostrum with two horns, 23-31  $\mu$  long, and laterally at each side with two hairs, the anterior of these 53-60  $\mu$  long, with a diameter

of the process 7-9  $\mu$ , the posterior hairs 50-57  $\mu$  long, with a diameter of the process 6-8  $\mu$ . Antennae pale brown, 224-248  $\mu$  long, 1.02-1.11 times as long as the distance between the outer margins of the eyes, with four segments, III and IV with spinulose imbrications, III, 76-86  $\mu$  long, 0.33-0.38 times as long as the distance between the outer margins of the eyes. Eyes brown, with three ommatidia, and about eight lumps in between; distance between the outer margins of the eyes 214-242  $\mu$ . Marginal wax glands of the prothorax are partly observable, at each side two marginal hairs, pronotum with two hairs. Wax glands of mesothorax and metathorax vaguely observable. Legs pale brown, the tibiae on the ventral side with spinulose imbrications, length of fore tibia 125-145  $\mu$ , 0.56-0.65 times as long as the distance between the outer margins of the eyes; the hind tibia distally with a sturdy hair, 40-43  $\mu$  long, and one spine, 12-13  $\mu$  long, two  $\mu$  wide near the base. Abdominal segments I-VII each with a marginal very pale brown sclerite with 4-7 wax glands, hairs of the tergites acute 18-23  $\mu$  long. Abdominal segment VIII with 15-17 wax glands along the posterior margin, with two hairs, 25-37  $\mu$  long. Siphunculi are lacking.

In later stages the antennae increase in length more than in *C. lataniae*, *C. freycinetiae* and *C. palmae*, the tibiae of the fore leg more than in *C. lataniae*.

Host plant records.— Specimens were collected in Java from *Pothos roxburghii* de Vriese, Bogor, Kebun Raya, 10.x.1976 and 25.xii.1976 by D. Noordam, and are in the collection at the Rijksmuseum van Natuurlijke Historie, Leiden.

Alatae were collected in both collections mentioned here.

Apterae live on the lower side of the leaves.

Etymology.— Pothophila, loving *Pothos*, genus name of the host plant *Pothos roxburghii* on which it was found. Gender: feminine (noun).

Discussion.— The key of apterae and alatae mentions in which characteristics *C. pothophila* differs from the other *Cerataphis* species, and the fact that the species lives on *Pothos*, a genus of Araceae, puts this species apart. It is confusing that one collection of *C. freycinetiae* was also from *Pothos*; whether or not in the latter case the identification of the plant is a mistake remains unsettled.

### Genus *Ceratoglyphina* Van der Goot, 1917 (figs. 245-258)

*Ceratoglyphina* Van der Goot, 1917: 235 (type species *Ceratoglyphina bambusae* Van der Goot, 1917).

L.K. Ghosh (1972) described a subspecies of *C. bambusae* subsp. *bengalensis*; this aphid is also collected on Java, and is considered by the author to be a species with the name *C. bengalensis* L.K. Ghosh, 1972.

Description (two species).— Apterous viviparous female.— In life: Pale brown, brown, black or with green longitudinal bands or marbled green, with a white fringe of wax.

Macerated specimens.— Body oval, 1.3-2.2 mm long, 1.2-1.6 times as long as it is wide. The head fused with the pronotum; mesonotum, metanotum, abdominal tergites VII and VIII distinctly defined, the other abdominal segments marginally fused but dorsally with some furrows. The head with two horns, finger-shaped or triangular with a sharp or somewhat rounded point, 125-240  $\mu$  long, with 8-18 hairs, which

increase in size to the base, 22-65  $\mu$  long. The head ventrally with 18-43 hairs. No wax glands on the head. Antennae with four or five segments, 303-539  $\mu$  long, 0.18-0.25 times as long as the body, and 0.60-0.85 times the width of the head across the eyes; the last antennal segment is 2.0-3.0 times as long as its processus terminalis. The eyes with three ommatidia. Ultimate rostral segment without accessory hairs, 0.5-0.8 times as long as the second tarsal segment of the hind leg; stylets 250-385  $\mu$  long.

Length of the head plus pronotum 0.46-0.57 times the width of the prothorax. The prothorax posteriorly with 3-7 marginal wax glands in a curved line. Mesothorax marginally with 0-12 wax glands in a straight line, transverse partition walls between glands of a group sometimes indistinct, mesonotum with 9-29 hairs. Wax glands in a straight longitudinal line on metathorax and abdominal segments I-VI marginally, usually located ventrally. Tibia of the fore leg 0.4-0.6 times as long as the width of the head across the eyes. Chaetotaxy of first tarsal segments 4, 3, 2. The second tarsal segment of the hind leg apically with four hairs expanded at the tips, the dorsal 41-61  $\mu$  long; empodial hairs of the hind leg 23-37  $\mu$  long.

Abdominal segments I-VII each with marginally up to 10 wax glands; in some specimens wax glands are lacking on some segments. Segment VII with 1-9 marginal glands, VIII on each side 2-6, lacking on the posterior margin; posterior margin of VIII emarginate. Tergite I with 11-22 hairs, V with 3-15, VII, 2-5; and VIII, 2-12; length of hairs on tergite IV, 25-40  $\mu$ ; on VIII, 69-130  $\mu$ . Siphunculi located on segment V, with 3-11 hairs, the pore 28-45  $\mu$ . Cauda without a constriction, 118-230  $\mu$  wide, pointing upwards 30-50  $\mu$ , with 11-28 hairs, the longest 60-115  $\mu$ . Subanal plate the posterior contour a slightly curved line, without an incision in the middle, with 35-70 hairs, the longest 78-130  $\mu$ . Subgenital plate with 4-7 anterior hairs, and 21-32 posterior hairs. Gonapophyses two, each with 8-17 hairs.

First stage larvae without siphunculi.

Alate viviparous female.— Body length 1.7-2.9 mm. The head with two blunt horns, 35-130  $\mu$  long, with 6-14 hairs, the longest 20-50  $\mu$ . The head ventrally posterior to median ocellus with in all 26-52 hairs. Antennae with five segments, 0.34-0.48 times as long as the body, segments III-V with ring-shaped rhinaria; segment III with 27-40 annular rhinaria, IV with 12-17, V with 3-16. The last rostral segment without accessory hairs, 71-83  $\mu$  long, 0.66-0.83 times as long as the second tarsal segment of the hind leg; length of the stylets 290-360  $\mu$ . The medial vein of the fore wing once branched, the hind wing with two oblique veins. Legs almost smooth, at most the tarsi with some smooth imbrications. Chaetotaxy of first tarsal segments 4, 3, 2. The apical hairs of the second tarsal segment of the hind leg with expanded tips, the dorsal hairs the most sturdy. Abdominal tergites I-VI colourless, IV with 14-16 hairs, V with 11-13, VI with 4-5. Tergite VII with two brown patches, each with one hair; VIII with a transverse brown band, with 7-12 hairs, 59-130  $\mu$  long. Siphunculi located on segment V, brown, with 3-11 hairs. Cauda without, or with an indistinct constriction, 134-215  $\mu$  wide, with 17-29 hairs, the longest 61-135  $\mu$ . Subanal plate slightly bilobed, the posterior contour a straight or slightly curved line, with 40-65 hairs, the longest 55-127  $\mu$ . Subgenital plate with 4-7 anterior hairs, and 25-49 posterior hairs. Gonapophyses two, each with 10-18 hairs. Embryos in the alatae are similar to first stage larvae of apterae.

Etymology.— *Ceratoglyphina*, with horns and cut into, carved, name given by Van der Goot (1917).

***Ceratoglyphina bambusae* Van der Goot, 1917**  
(figs. 245-251)

*Ceratoglyphina bambusae* Van der Goot, 1917: 237.

Types— Lectotype (aptera vivipara) from bamboo, Salatiga, Java, 12.vii.1915, leg. P. van der Goot, no. 286-1, Det. P. van der Goot: *Ceratoglyphina bambusae*. Paralec-  
totypes: 21 aptera viviparae (partly fragmentary) on nine slides with the same data  
as the lectotype, but dates 12.vii.1915, and 19.vii.1915. Lectotype and paratypes in the  
collection at the Laboratorium voor Entomologie, Wageningen.

Apterous viviparous female.— In life (pls 24-26): Body dull brown, blackish  
brown or marbled dark greenish black, horns and abdominal segment VIII brown;  
frequently the anal plate is visible, a brighter brown than segment VIII. Antennae  
and legs rather pale brown. A median line on head and thorax, whitish due to wax,  
and also transversely some wax at the borders of the thoracic segments. Eyes black.  
A flat fringe of wax up to about 0.2 mm wide from the posterior part of the protho-  
rax to the margins of abdominal segment VIII, lacking around the head and at the  
posterior margins of abdominal segment VIII. Larvae yellowish or pale green or  
bluish green, the larger larvae with brown heads.

Macerated specimens.— (fig. 245; described from 16 specimens): Body oval, 1.34-  
2.20 mm long, and 1.01-1.64 mm wide, 1.2-1.5 times as long as it is wide, the dorsum  
wholly brown, sclerotic, mesothorax, metathorax, abdominal segments VII and VIII  
distinctly defined, the other abdominal segments marginally fused, dorsally distinct  
furrows between segments II and III, and between VI and VII, and less distinct  
between the other segments, intensified by the intersegmental muscle plates.

Head.— Head across the eyes 441-670  $\mu$  wide, fused with the prothorax, dorsally  
almost smooth, with dots of less than one  $\mu$ , arranged in ovals, groups of 4-7 oval  
muscle plates, e.g. close to the base of the horns and posterior to the eyes without  
these dots. Frons with two finger-shaped or triangular horns, somewhat wrinkled,  
with sharp or somewhat rounded points, darker brown than the head, 125-200  $\mu$   
long, with 8-10 hairs, the longest 22-33  $\mu$ . Dorsally three transverse rows of hairs,  
anterior four hairs, or less if some are included with the horns, 22-31  $\mu$  long; middle  
row, anterior to the eyes 4-5 hairs, posterior row four hairs. Ventrally, posterior to the  
horns 18-37 hairs. Antennae brown, with four or five segments, 303-475  $\mu$  long, 0.18-  
0.25 times as long as the body, 0.60-0.79 times the width of the head across the eyes,  
segments I and II smooth, III dorsally smooth or distally with some spinulae, ven-  
trally with spinulose imbrications; last segment and in five-segmented antennae also  
IV ventrally and dorsally with spinulose imbrications; hairs on segment III, 20-30  $\mu$   
long. Length of segments in four-segmented antennae: III, 120-177  $\mu$ ; IV, 98-140  $\mu$ ; III,  
1.1-1.4 times as long as IV. In five-segmented antennae length of III, 98-143  $\mu$ ; IV, 65-  
106  $\mu$ ; V, 115-134  $\mu$ ; III is 1.1-1.7 times as long as IV, 0.8-1.1 times as long as V, IV is  
0.56-0.84 times as long as V. Ultimate rostral segment 53-78  $\mu$  long, 0.55-0.80 times the  
length of the second tarsal segment of the hind leg, without accessory hairs; stylets  
250-342  $\mu$  long. Eyes at the margins of the head, with three ommatidia.

Thorax.— Length of head plus pronotum 0.46-0.57 times the width of the protho-  
rax; the prothorax at each side with two marginal hairs and posteriorly with 3-7  
marginal wax glands in a curved line. Mesothorax with usually 7-10 wax glands in a

straight line along the whole margin, the glands sometimes united into one long gland without partition; mesonotum with 9-18 hairs. Metathorax with 7-9 wax glands, as on mesothorax, metanotum with 9-16 hairs. Legs brown, smooth, also the tarsi. Tibia of the fore leg 200-325  $\mu$  long, 0.41-0.55 times as long as the width of the head across the eyes. Chaetotaxy of first tarsal segments 4, 3, 2, hairs of the hind leg 35-48  $\mu$  long; the second tarsal segment of the hind leg apically with four hairs expanded at the tips, the longest 41-57  $\mu$ ; empodial hair of the hind leg 29-37  $\mu$  long. Length of segments of the hind leg: femur plus trochanter 265-425  $\mu$ , tibia 295-472  $\mu$ , first tarsal segment 33-55  $\mu$ , second tarsal segment 76-118  $\mu$ , the tibia is 1.06-1.17 times as long as the femur.

Abdomen.— Tergites I-VI brown sclerotic, fused, the outline smooth without any incision, or a little between V and VI; tergite VII somewhat fused with VI, the anterior part brown, the posterior part almost colourless, with spinulose imbrications; VIII distinctly defined, with spinulose imbrications and some wrinkles, brown, with a colourless posterior border, emarginate in the middle about 40  $\mu$ ; dorsal to the marginal wax glands one hair on each of the segments I-VII, observable marginally or ventrally; the wax glands arranged in a straight line, usually occupying the whole length of the segments, with an interval between the segments of 0-8  $\mu$ , the wax glands are without an outer chitinous wall, and partitions between the glands are lacking, so the number of glands on the segments cannot always be counted; the glands are situated ventrally on segments I-VI, ventrally or marginally on VII, marginally on VIII, not on the posterior margin; the glands are rectangular, flattened up against each other, usually 30-40  $\mu$  wide, with facets of 3-4  $\mu$  diameter, the contour of the facets composed of 6-12 dots; number of wax glands, if countable, on segments I-VII on each side 5-7, in some specimens no wax glands were present on segments IV-VI, and one only on segments I and VII; number of wax glands on VIII, 2-5 on each side. Tergite I with 11-17 hairs, II, 8-16; III, 7-15; IV, 4-14; V, 3-11; VI, 2-6; VII, 2-4; and VIII, including the hairs ventral to the wax glands, 2-8, spinal hairs are lacking; length of hairs dorsally on segment IV, 25-41  $\mu$ , ventrally on IV, 22-33  $\mu$ ; on tergite VIII, 69-93  $\mu$ . Siphunculi located on segment V, cone-shaped, about 30  $\mu$  high, brown as the surroundings, and without a distinct border, with concentric wrinkles, with 3-6 hairs, about 30-40  $\mu$  long; pore brown, with a diameter of 28-38  $\mu$ . Cauda pale brown, without constriction, 118-195  $\mu$  wide at the base, pointing upwards about 30  $\mu$ , with 11-22 hairs on the top, the longest 69-96  $\mu$ . Subanal plate brown, broadly rounded e.g. 285  $\mu$  wide at the distal part and 130  $\mu$  long, the distal part with 35 to about 60 hairs, the longest 78-104  $\mu$ . Subgenital plate with 4-6 anterior hairs, the longest 37-50  $\mu$ , and 21-32 posterior hairs, the longest 39-53  $\mu$ . Gonapophyses two, each with 8-15 hairs, the longest 20-27  $\mu$ .

Alate viviparous female.— In life: Head, horns, antennae, legs and mesothorax black. Prothorax and abdomen yellowish brown. Pterostigma, radial sector, cubital vein, anal vein and part of the hind margin of the fore wing black. Larvae brownish with a fringe of wax.

Macerated specimens.— (figs. 246-250; described from nine specimens): Body length 1.75-2.18 mm, 1.7-2.0 times as long as it is wide.

Head.— (fig. 246). Head black, dorsally smooth but somewhat wrinkled with blunt spinulae close to the paired ocelli and the horns, width across the eyes 433-505  $\mu$ , anterior to the paired ocelli 0-2 hairs, posterior 4-6, about 25  $\mu$  long; frons with two



blunt horns, 35-76  $\mu$  long, with 6-8 hairs, the longest 20-27  $\mu$ ; ventrally posterior to the median ocellus in all 26-33 hairs. Antennae (fig. 247) brown with black rings, with five segments 780-900  $\mu$  long, 0.41-0.48 times as long as the body, and 1.7-2.0 times the width of the head across the eyes; segment I somewhat wrinkled, segment II with longitudinal wrinkles and distally, at the dorsal and ventral sides with some spinulose imbrications, the spinulae up to two  $\mu$  long; segments III-V with ring-shaped secondary rhinaria, the rings are not closed on the dorsal side, with a space of 5-30  $\mu$ ; between the rhinaria are 2-4 concentric ring-shaped spinulose imbrications, mainly on the dorsal side with interconnections. The rhinaria are 2-4  $\mu$  wide. The primary rhinaria are between the annular rhinaria, and are moulded with them to a complex structure; segment III with 27-40 annular rhinaria, IV with 12-17, V with 10-16; segment III hairs 10-18  $\mu$  long. Length of segment III, 325-417  $\mu$ ; IV, 157-205  $\mu$ ; V, 169-210  $\mu$ ; segment III is 1.9-2.3 times as long as IV, 1.8-2.2 times as long as V, 0.9-1.1 times as long as IV plus V; segment IV is 0.89-1.03 times as long as V. The last rostral segment is 71-81  $\mu$  long, 0.71-0.83 times as long as the second tarsal segment of the hind leg, without accessory hairs; length of stylets 290-315  $\mu$ . Eyes compound, the ocular tubercle extending sideways about 30  $\mu$ .

Thorax.— Prothorax brown, mesothorax dark brown. Fore wing (fig. 248) veins and hind margin bordered slightly with brown, medial vein once branched, the hind wing with two oblique veins. Legs brown, the distal end of the femur and the base of the tibia dorsally black, almost smooth, also the tarsi; tibia of the fore leg 445-510  $\mu$  long, 1.0-1.1 times as long as the width of the head across the eyes, length of hairs of the hind tibia 29-35  $\mu$ ; chaetotaxy of first tarsal segments (fig. 249) 4, 3, 2, length of lateral hairs three times as long as the middle; length of hairs of first tarsal segment of the hind leg 43-49  $\mu$ ; the apical hairs of the second tarsal segment of the hind leg with expanded tips, the dorsal hairs the most sturdy, 47-53  $\mu$  long, the tip 4  $\mu$  wide; length of the empodial hair of the hind leg 29-35  $\mu$ . Length of hind segments: femur fused with trochanter 441-492  $\mu$ , tibia 606-669  $\mu$ , 1.3-1.4 times as long as the femur, and 1.3-1.4 as long as the width of the head across the eyes; first tarsal segment 39-44  $\mu$ , second tarsal segment 98-103  $\mu$ .

Abdomen.— (fig. 250). Abdominal segments I-III colourless, IV marginally with a very pale brown patch, V-VII with a larger brown marginal patch with some wrinkles and spinulose imbrications, and some hairs, the dorsum of segments IV-VI colourless, VII with two brown patches each with a hair; VIII the posterior margin straight or somewhat emarginate, with a brown transverse band, all sclerotic parts of the segments with spinulose imbrications; between the dorsum of V and VI, and VI and VII two small, brown intersegmental muscle plates. Number of hairs on tergite I, 11-17; II, 10-15; III, 9-13; IV, 9-13; V, 6-9; VI, 3-4; VII, 1-3, and VIII with 5-6, one of these on each side usually marginally; length of hairs dorsally on segment IV, 31-41  $\mu$ , ventrally on IV, 27-41  $\mu$ , on tergite VIII, 59-74  $\mu$ . Siphunculi located on segment V, brown, cone-shaped, about 15  $\mu$  high, with concentric spinulose imbrications and ridges, at the base 70-90  $\mu$  wide, with 3-6 hairs, 33-43  $\mu$  long; the pore darker brown, with a diameter of 30-35  $\mu$ . Cauda colourless 134-186  $\mu$  wide, a constriction lacking or indistinct, with 17-22 hairs, the longest 61-84  $\mu$ . Subanal plate slightly bilobed, pale brown, but ventrally in the middle brown, and emarginated about 10  $\mu$ , the posterior contour a straight or slightly curved line or emarginated not more than 4  $\mu$ , with about 40 hairs, the longest 55-80  $\mu$ . Subgenital plate with 4-7 anterior hairs, the

longest 35-51  $\mu$ , and 25-32 posterior hairs, the longest 50-59  $\mu$ . Gonapophyses two, each with 10-15 hairs, the longest 18-27  $\mu$ . Abdominal spiracles on seven segments, I-VII.

First stage larva of apterous viviparous female (fig. 251; description of one specimen): Body length 855  $\mu$  (other specimens 630-1135  $\mu$ ), length of head plus pronotum 255  $\mu$ , width of prothorax 390  $\mu$ ; head across eyes 326  $\mu$  wide (in other specimens 228-375  $\mu$ ), anterior to the eyes a swelling, 12  $\mu$  high, 40  $\mu$  wide, with small blisters; the head dorsally with three transverse rows of hairs, the anterior with 2-4, the others with four hairs, about 22  $\mu$  long; ventrally on each side 4-6 hairs, the longest 50  $\mu$ . Antennae with four segments, 290  $\mu$  long, segment III, 99  $\mu$  long; IV, 110  $\mu$ , both with spinulose imbrications; length of hair on segment II, 40  $\mu$ ; on III, 35  $\mu$ . Two frontal horns, pointed, somewhat wrinkled, 85  $\mu$  long, longest hair 30  $\mu$ . Prothorax with two dorsal hairs, on each side posteriorly with four wax glands, mesothorax and metathorax marginally with about 10 and eight wax glands respectively. Tibia of fore leg 216  $\mu$  long, 0.66 times as long as the width of the head across the eyes. Length of distal hair of the hind tibia 50  $\mu$ . All first tarsal segments with two hairs, about 60  $\mu$  long. Apical hairs of the second tarsal segment of the hind leg with expanded tips, the dorsal ones 50  $\mu$  long. Abdominal segments I-VIII free, marginally each segment with 4-6 wax glands in a line over their whole length, with intersegmental spaces, dorsal to the glands one hair on each side of the segments, about 40  $\mu$  long; tergites I-V with four hairs, VI with 1-3, VII with two, VIII with usually four, but one specimen with two; length of hairs dorsally on segment IV, 18  $\mu$ ; on VIII, 57  $\mu$ . Cauda with two hairs, 40  $\mu$  long. Siphunculi are lacking.

From larval stages in the slides it is concluded that adult viviparous apterae develop from third stage larvae, adult viviparous alatae from fourth stage larvae.

Host plant records.— Specimens were collected in Java from bamboo, in the places and on the dates indicated, while the collectors are indicated by numbers between parentheses: Van der Goot (1), in the collection at the Laboratorium voor Entomologie, Wageningen; F.W. Rappard (2), in the collection at the British Museum (Natural History), London; and D. Noordam (3), in the collection at the Rijksmuseum van Natuurlijke Historie, Leiden. Bamboo, Salatiga, 12.vii.1915, 19.vii.1915 (1); *Schizostachyum brachycladum* (Kurz) Kurz, Badean (300 m) - Djember, 1.x.1949 (2); bamboo, Petoeng-Djember (50 m), 22.vii.1950 (2); *Phyllostachys kumasaca* (Zoll. ex Steud.) Munro, Punten (1200 m), 8.iv.1951 (2); *Gigantochloa apus* (Bl. ex Schult.f.), Kurz, Bogor, 1.vi.30.vii.1956, leg. Prof. P. Büchner, B 18; bamboo, Sindanglaya (1100 m), 29.iv.1975, 21.x.1975 (3); *Schizostachyum blumii* Nees, Bogor, Kebun Raya, 27.ii.1976 (3); bamboo, Cipanas (1000 m), 22.ix.1976 (3); bamboo, Bogor, Kebun Raya, 23.xii.1976 (3); bamboo, Bogor (500 m), 30.iv.1977 (3); *Schizostachyum zollingeri* Steud., Bogor, Kebun Raya, 15.v.1977 (3); bamboo, Sindanglaya (1100 m), 2.xi.1977 (3); bamboo, Bogor, Kebun Raya, 6.xi.1977 (3); *Schizostachyum spec.*, Bogor, Kebun Raya, 16.xii.1977 (3); bamboo, Lawang (500 m), 27.xii.1977 (3).

The aphids live on the innerside of young sheaths and the upperside of leaves at the joint of the sheaths, sometimes very densely crowded, occasionally on young sprouts on the outside.

Alatae or larvae of alatae were collected on 27.ii.1976, 15.v.1977, 2.xi.1977, all with embryos similar to first stage larvae of apterae from bamboo.

Etymology.— Van der Goot (1917) gave the name bambusae, from *Bambusa*, one of the genera which reminds one of bamboo from which he collected the aphid.

***Ceratoglyphina bengalensis* L.K. Ghosh, 1972 stat. nov.**  
(figs. 252-258)

*Ceratoglyphina bambusae* subsp. *bengalensis* L.K. Ghosh, 1972: 301.

Types.— Holotype in the collection of the Zoological Survey of India, Calcutta. Paratypes as holotype and in the British Museum (Natural History), London.

Apterous viviparous female.— In life (pl. 27): Head and body pale brown, sometimes the body with two longitudinal green bands vaguely observable. Legs pale brown. A narrow, flat, white fringe at the posterior part of the prothorax to the margins of abdominal segment VIII. Larvae pale green with darker green longitudinal band on mesothorax, metathorax and abdomen, head and prothorax brown.

Macerated specimens.— (fig. 252; described from six specimens): Body oval, 2.10-2.46 mm long, and 1.65-1.86 mm wide, 1.2-1.4 times as long as it is wide, the dorsum wholly brown, sclerotic; mesothorax, metathorax, abdominal segments VII and VIII distinctly defined, the other segments marginally fused, dorsally distinct furrows between segments II and III, and between IV and VII, and less distinct between the other segments, intensified by the intersegmental muscle plates.

Head.— Head across the eyes 620-710  $\mu$  wide, fused with the prothorax, dorsally almost smooth, with dots of less than one  $\mu$ , arranged in ovals, groups of 3-6 oval muscle plates, e.g. near to the base of the horns, and posterior to the eyes without these dots. Frons with two finger-shaped horns, somewhat wrinkled, with sharp points, 180-240  $\mu$  long, with 14-18 hairs, the longest 60-65  $\mu$ . Dorsally three transverse rows of hairs: anterior 0-3 hairs, the longest 43-60  $\mu$ ; middle row, anterior to the eyes 5-7 hairs; posterior row four hairs. Ventrally posterior to the horns 40-45 hairs. Antennae brown, with four or five segments, 485-540  $\mu$  long, 0.20-0.23 times as long as the body, 0.69-0.85 times the width of the head across the eyes, segments I and II with some longitudinal ridges, for the rest smooth, III dorsally smooth or distally with some spinulae, ventrally with spinulose imbrications, segment IV in five-segmented antennae mainly ventrally with spinulose imbrications, the last segment dorsally and ventrally with spinulose imbrications; longest hair on segment III, 45-60  $\mu$ . Length of segments in four-segmented antennae: III, 225  $\mu$ , 1.6-1.7 times as long as IV; IV, 130-140  $\mu$ ; in five-segmented antennae length of III, 150-174  $\mu$ ; IV, 80-106  $\mu$ ; V, 125-140  $\mu$ ; III is 1.6-1.9 times as long as IV, 1.2-1.4 times as long as V, and IV is 0.61-0.84 times as long as V. Ultimate rostral segment 78-86  $\mu$  long, 0.66-0.71 times as long as the second tarsal segment of the hind leg, without accessory hairs; stylets 360-385  $\mu$  long. Eyes at the margins of the head, with three ommatidia.

Thorax.— Length of head plus pronotum 0.49-0.54 times the width of the prothorax; the prothorax on each side with two marginal hairs, and posteriorly with 4-6 marginal wax glands in a curved line, the glands indistinctly defined. Mesothorax on each side with 11-12 wax glands in a straight line along the whole margin, mesonotum with 14-29 hairs. Metathorax with 10-12 wax glands as on mesothorax, metanotum with 14-21 hairs. Legs brown, smooth, also the tarsi. Tibia of the fore leg 310-365  $\mu$  long, 0.46-0.59 times as long as the width of the head across the eyes. Chaetotaxy of first tarsal segments 4, 3, 2, length of hairs of the hind tarsus 37-50  $\mu$  long; the second tarsal segment of the hind leg apically with four hairs expanded at the tips, the longest 51-61  $\mu$  long; empodial hair of the hind leg 23-35  $\mu$  long. Length of segments of the hind leg: femur plus trochanter 465-492  $\mu$ , tibia 480-543  $\mu$ , first

tarsal segment 50-53  $\mu$ , second tarsal segment 116-125  $\mu$ , the tibia is 1.05-1.11 times as long as the femur.

Abdomen.— Segments I-VII dorsally brown, sclerotic, fused, the outline smooth without any incision, the border between segments VI and VII, however, observable; VI and VII with spinulose imbrications; VIII distinctly defined, with spinulose imbrications, brown, sometimes with a narrow posterior border, emarginate in the middle 20-45  $\mu$ ; dorsal to the marginal wax glands one hair on each of segments I-VII, observable marginally or ventrally; the wax glands are arranged in a straight line, occupying the whole length of the segments, with a space between segments I-VII of 5-12  $\mu$ , and are located ventrally on segments I-VI and the anterior part of VII, and marginally on the posterior part of VII; on segment VIII the glands are located dorsally or somewhat marginally; the glands are without an outer chitinous wall, the partitions between the glands are at the most one  $\mu$  wide, the facets 2-4  $\mu$ . Number of wax glands on the segments: I, 7-10; II, 8-10; III, 8-10; IV, 7-9; V, 8-10; VI, 6-9; VII, 7-9, and VIII, 3-6. Tergite I with 16-22 hairs; II, 17-23; III, 15-24; IV, 13-18; V, 11-15; VI, 4-7; VII, 4-5; and VIII, including the hairs ventral to the wax glands 9-12; length of hairs dorsally on segment IV, 30-40  $\mu$ ; ventrally on IV, 41-53  $\mu$ ; on tergite VIII, 92-130  $\mu$ . Siphunculi located on segment V, cone-shaped, about 30  $\mu$  high, brown as the surroundings, and without a distinct border, with concentric wrinkles, with 6-11 hairs, the longest 49-70  $\mu$ ; pore brown, with a diameter of about 35  $\mu$ . Cauda pale brown, without constriction, 202-230  $\mu$  wide at the base, pointing upwards about 40-50  $\mu$ , with 25-28 hairs on the top, the longest 100-115  $\mu$ . Subanal plate brown, slightly darker ventrally in the median area, broadly rounded without incision, e.g. 320  $\mu$  wide at the distal part, and 125  $\mu$  long, the distal part with about 60-70 hairs, the longest 110-130  $\mu$ . Subgenital plate with 5-7 anterior hairs, the longest 72-82  $\mu$ , and 26-32 posterior hairs, the longest 50-63  $\mu$ . Gonapophyses two, each with 10-17 hairs, the longest 18-33  $\mu$ .

Alate viviparous female.— In life: Head, horns, antennae, legs and mesothorax black, abdomen greenish black, the distal part paler. Abdomen ventrally with wax, but lacking in the median area. Larvae brownish with two darker longitudinal bands.

Macerated specimens.— (figs. 253-257; described from 3 specimens): Body length 2.29-2.87 mm, 1.8 times as long as it is wide.

Head.— (fig. 253). Head black, dorsally smooth with some wrinkles, width across the eyes 540-554  $\mu$ , anterior to the paired ocelli seven hairs, posterior 4-5, about 40  $\mu$  long; frons with two blunt horns, 90-130  $\mu$  long, with about 14 hairs, the longest 40-50  $\mu$ ; ventrally posterior to the median ocellus in all 40-45 hairs. Antennae brown, with black rings, with five segments, 900-987  $\mu$  long, 0.34-0.40 times as long as the body, and 1.7-1.8 times the width of the head across the eyes; segment I somewhat wrinkled, segment II with longitudinal wrinkles and distally, at the dorsal and ventral sides, with some spinulose imbrications, the spinulae up to two  $\mu$  long; segments III-V (fig. 254) with ring-shaped secondary rhinaria, the rings are not closed on the dorsal side, with a space of 5-30  $\mu$ ; between the rhinaria are 2-4 concentric ring-shaped spinulose imbrications, mainly on the dorsal side with interconnections; the rhinaria are 2-4  $\mu$  wide, but at the base of segment III wider, with in each rhinarium some slits. The primary rhinaria are between the annular rhinaria, and are moulded with them to a complex structure; segment III with 37-39 annular rhinaria,

IV with 12-15, and V with 3-12; hairs of segment III, 33-47  $\mu$  long. Length of segment III, 425-500  $\mu$ ; IV, 170-180  $\mu$ ; V, 138-178  $\mu$ ; segment III is 2.4-2.8 times as long as IV, 2.4-3.4 times as long as V, and 1.2-1.5 times as long as IV plus V; segment IV is 0.98-1.23 times as long as V. The last rostral segment is 83  $\mu$  long, 0.66-0.73 times as long as the second tarsal segment of the hind leg, without accessory hairs; length of stylets 320-360  $\mu$ . Eyes compound, the ocular tubercle extending sideways about 40  $\mu$ .

Thorax.— Prothorax brown, mesothorax dark brown. Fore wing (fig. 255) veins, and hind margin slightly bordered with brown, medial vein once branched, the hind wing with two oblique veins. Legs brown, the distal part of the femur and the basal part of the tibia darker, almost smooth, but the tarsi with some smooth imbrications. Tibia of the fore leg 1.2-1.3 times as long as the width of the head across the eyes, length of hairs of the hind tibia 72-78  $\mu$ ; chaetotaxy of first tarsal segments 4, 3, 2, the lateral hairs 2-2.5 times as long as the middle; length of hairs of first tarsal segment of the hind leg 51-53  $\mu$ ; the apical hairs of the second tarsal segment of the hind leg with expanded tips, the dorsal hairs the most sturdy, 55  $\mu$  long, the tip 4  $\mu$  wide; length of the empodial hair of the hind leg 31-37  $\mu$ . Length of hind segments: femur fused with trochanter 582-650  $\mu$ , tibia 810-947  $\mu$ , 1.4-1.5 times as long as the femur, and 1.5-1.7 times the width of the head across the eyes, first tarsal segment 47  $\mu$ , second tarsal segment 113-126  $\mu$ .

Abdomen.— (fig. 257). Abdominal segments I-VI colourless, VII marginally a brown patch with 5-9 hairs, the dorsum with two brown patches 30-40  $\mu$  diameter, each with one hair, the brown parts with spinulose imbrications; VIII with the posterior margin emarginate, in the middle about 35  $\mu$ , with a transverse brown band, the borders colourless, all sclerotic parts with spinulose imbrications and radial ridges around the hairs. Number of hairs on tergite I, 17-19; II, 19-23; III, 16-18; IV, 15-16; V, 12-13; VI, 4-5; VII, 2-3; and VIII, 7-12; length of hairs dorsally on segment IV, 49-59  $\mu$ , ventrally on IV, 49-66  $\mu$ , on tergite VIII, 115-130  $\mu$ . Siphunculi located on segment V, brown, cone-shaped, about 20  $\mu$  high, with concentric ridges, at the base 90-125  $\mu$  wide, with 7-11 hairs, 54-73  $\mu$  long; the pore darker brown, with a diameter of about 35  $\mu$ . Cauda pale brown 205-215  $\mu$  wide, without a constriction, with 28-29 hairs, the longest 116-135  $\mu$ . Subanal plate slightly bilobed, pale brown, but ventrally in the middle brown and emarginated about 10  $\mu$ , the posterior contour an almost straight or slightly curved line, with about 60-65 hairs, the longest 125-127  $\mu$ . Subgenital plate with 5-7 anterior hairs, the longest 65-80  $\mu$ , and 25-32 posterior hairs, the longest 50-59  $\mu$ . Gonapophyses two, each with 12-18 hairs, the longest 25-30  $\mu$ . Spiracles on eight abdominal segments.

First stage larva of apterous viviparous female (fig. 258; description of one specimen): Body length 1145  $\mu$  (other specimens 790-1245  $\mu$ ), length of head plus pronotum 315  $\mu$ , width of prothorax 480  $\mu$ , head across eyes 350  $\mu$  wide (in other specimens 310-385  $\mu$ ), anterior to the eyes a swelling, eight  $\mu$  high, 40  $\mu$  wide, with small blisters; the head dorsally with three transverse rows of hairs, the anterior with 1-5, the middle with 4-6, the posterior with four hairs, about 25  $\mu$  long. Antennae with four segments, 315  $\mu$  long, segment III, 118  $\mu$ ; IV, 118  $\mu$ ; both with spinulose imbrications, length of hair on segment II, 50  $\mu$ ; on III, 65  $\mu$ . Two frontal horns, pointed, somewhat wrinkled, 108  $\mu$  long, longest hair 50  $\mu$ . Prothorax with three dorsal hairs, posteriorly on each side with five wax glands; mesothorax and metathorax marginally with 10-12, and 8-10 wax glands respectively. Tibia of fore leg 224  $\mu$  long, 0.64

times as long as the width of the head across the eyes, length of distal hair of the hind tibia 63  $\mu$ . All first tarsal segments with two hairs, about 60  $\mu$  long. Apical hairs of the second tarsal segment of the hind leg with expanded tips, the dorsal ones 55  $\mu$  long. Abdominal segments I-VIII free, marginally each segment with wax glands in a line over their whole length, with intersegmental spaces, dorsal to the glands one hair on each side of the segments, 60-80  $\mu$  long, tergites I-V with 5-7 hairs, VI with 4-5, VII with 3-4, and VIII with 4-6; length of hairs dorsally on segment IV, 20  $\mu$ ; on VIII, 96  $\mu$ . Cauda with 4-6 hairs, the longest 60-70  $\mu$ . Siphunculi are lacking.

Host plant records.— Specimens were collected in Java from bamboo, at Sindanglaya (1100 m), 21.x.1975, and 6.iii.1976 by D. Noordam, in the collection at the Rijksmuseum van Natuurlijke Historie, Leiden.

The aphids live on the border of the sheath and on the base of the leaf of young sprouts. Alatae were collected on 6.iii.1976, all with embryos similar to first stage larvae of apterae from bamboo.

Etymology.— L.K. Ghosh (1972) gave the name *bengalensis*, from Bengal, the area of India where the aphids described by Ghosh were collected.

Discussion.— This aphid was described by Ghosh (1972) as a subspecies of *C. bambusae* but because there are so many distinct differences such as the colour in life, the more numerous and longer hairs on many parts of the body, this aphid must be considered as a species.

#### Genus *Ceratovacuna* Zehntner, 1897 (figs. 259-284)

*Ceratovacuna* Zehntner, 1897: 29 (type species *Ceratovacuna lanigera* Zehntner, 1897).  
*Oregma*; partly Van der Goot, 1917: 171, 190.

Description (five species).— Apterous viviparous female.— In life: Yellow, brown or wholly black, the margins with white wax cones, or the whole body densely covered with wax, sometimes with long threads.

Macerated specimens.— Body length 1.4-2.4 mm, 1.4-2.3 times as long as it is wide. The head fused with the pronotum; mesonotum, metanotum and abdominal tergites more or less colourless, and not fused. The head with two horns, usually triangular with sharp points, 25-88  $\mu$  long (in *C. graminum* up till 113  $\mu$  long), with 6-10 hairs, 4-8  $\mu$  long. The head dorsally and ventrally with normal hairs, dorsally 45-91  $\mu$  long. Wax glands medial to the eyes in an oval group of 8-13, 2-4, or lacking. Antennae with four or five segments, 220-470  $\mu$  long, 0.12-0.32 times as long as the body, and 0.5-1.3 times the width of the head across the eyes; the last antennal segment 2.3-4.0 times as long as the processus terminalis. The eyes with three ommatidia. Ultimate rostral segment without accessory hairs, 0.45-0.80 times as long as the second tarsal segment of the hind leg; stylets 205-330  $\mu$  long. Length of the head plus pronotum 0.64-0.82 times the width of the prothorax. The pronotum at the posterior margin pleurally a distinct or rather indistinct groove; a swelling along the posterior margin, on each side of the median line is lacking.

Marginal wax glands in an oval group on prothorax, mesothorax and metathorax numbering 6-14 in three species, in the other species smaller numbers or the wax

glands are lacking; in *C. keduensis* and *C. graminum* two oval groups of 1-5 glands spinally on each of the thoracic segments, but in other species spinal wax glands are lacking. Tibia of the fore leg 0.7-1.2 times as long as the width of the head across the eyes. First tarsal segments of the fore leg with 2-4 hairs, of the midleg with 2-3, of the hind leg with two. The second tarsal segment of the hind leg apically with 1-2 hairs with expanded tips, 46-67  $\mu$  long; empodial hairs of the hind leg 20-36  $\mu$  long, but in *C. floccifera* 0-6  $\mu$ . Marginal wax glands, in groups on each of the abdominal segments, in numbers of 3-17, or lacking on some or all segments; spinal wax gland groups on abdominal segments I-VII in *C. keduensis* and *C. graminum* as on the thorax, in numbers of 3-18. Abdominal tergites I-V each with 2-9 hairs, VI with 2-4, VII with 1-3, but in *C. graminum* I-V with 6-22, VI with 6-11, and VII with 4-7 hairs; length of hairs on tergite IV, 36-85  $\mu$ . Tergite VIII with a transversely elongate, usually pale brown plate with 5-40 wax glands in an oval group; the membrane of the wax glands with regularly distributed dots or pores, or with facets; with 4-9 hairs, two of which spinally, anterior to the wax glands, 45-74  $\mu$  long. Siphunculi located on segment V, a colourless, pale brown or brown ring extending around the pore 6-20  $\mu$ , with some concentric wrinkles, without hairs; the pore colourless or brown, elevated above the surroundings 10-25  $\mu$ , with a diameter of 40-63  $\mu$ . Cauda transversely elongate, a knob with a constriction, with 10-19 hairs, the longest 45-80  $\mu$ . Subanal plate bilobed with 12-23 hairs, the longest 47-84  $\mu$ . Subgenital plate with 3-8 anterior hairs, and 7-20 posterior hairs. Gonapophyses two, each with 2-8 hairs.

First stage larvae of apterae of *C. floccifera* and *C. keduensis* without siphunculi, but of *C. lanigera* and *C. panici* with siphunculi. In *C. floccifera* are two types of first stage larvae: I normal developing to later stages, and II soldiers with giant horns.

Alate viviparous female.— In life: Black or black with a yellowish or brown abdomen.

Macerated specimens.— Body length 1.6-2.6 mm. The head with two frontal horns, up to 25  $\mu$  long, or lacking, but 4-8 hairs occur on their location, 2-10  $\mu$  long. The head ventrally, posterior to the median ocellus with in all 9-18 hairs. Antennae with five segments, but in *C. keduensis* with four or five, 0.20-0.41 times as long as the body, and 0.9-1.9 times the width of the head across the eyes, the tip of the last segment, distally to the ultimate rhinarium 15-33  $\mu$  long. Antennal segments III-V with ring-shaped secondary rhinaria; between the rhinaria 3-5 concentric spinulose imbrications; the primary rhinaria between the annular rhinaria and moulded with these to a complex structure; segment III with 16-35 (in antennae with four segments up till 45), IV with 5-15, V with 2-14 annular rhinaria. Last rostral segment 0.49-0.85 times as long as the second tarsal segment of the hind leg; length of the stylets 230-310  $\mu$ . Eyes compound. Fore wing medial vein once branched, the hind wing with two oblique veins. First tarsal segment with 3-4 hairs, of the midleg usually with three, of the hind leg usually with two. Second tarsal segment of the hind leg with 0-1 dorsoapical hair, expanded at the tip. Abdominal segments I-V or I-VI colourless, segment VI sometimes with some small pale brown spots or with a transverse band, VII sometimes with a pale brown transverse band, and VIII usually pale brown; tergite IV with 3-10 hairs, 18-45  $\mu$  long, VIII with 5-10 hairs, 27-55  $\mu$  long. Siphunculi located on segment V, around the pore an indistinct or asymmetric pale brown ring, at its widest part 5-10  $\mu$  outside the pore, without hairs. Cauda transversely elongate, a knob with constriction, with 10-20 hairs, the longest 39-78  $\mu$ . Subanal plate bilobed,

with 13-28 hairs, the longest 49-90  $\mu$ . Subgenital plate with 4-19 anterior hairs, and 9-16 posterior hairs. Gonapophyses two, each with 6-11 hairs.

The embryos in the abdomen of the alatae frequently as first stage larvae of apterae but in *C. floccifera* embryos with shorter horns and wax glands on more segments of the body than first stage larvae of apterae of the same collection; in one collection of *C. lanigera* (no. 975) embryos without horns, presumably without siphunculi, and without groups of wax glands.

**Etymology.**— *Ceratovacuna*, *Vacuna* with horns, name given by Zehntner (1897).

***Ceratovacuna floccifera* spec. nov.**  
(figs. 259-267)

**Types.**— Holotype (aptera vivipara) from bamboo leaf, Linggadjati, Java, Indonesia, no. 119-13-1, 25.vii.1919, leg. P. v.d. Goot, det. P. v.d. Goot: *Oregma floccifera*. Paratypes: 35 apterae viviparae and 19 alatae viviparae, same locality, host plant and data as the holotype leg. P. v.d. Goot, on 16 slides. Holotype and paratypes in the collection at the Laboratorium voor Entomologie, Wageningen.

This aphid was collected by Van der Goot, and the data on the slides are the only particulars available, and these are mentioned further on.

**Apterous viviparous female.**— In life unknown.

**Macerated specimens.**— (fig. 259; described from six specimens). Body length 1.43-1.58 mm, slender, 1.8-2.3 times as long as it is wide.

**Head.**— Head pale brown, almost smooth, the frons straight or slightly curved, in one specimen only with a median tubercle six  $\mu$  high, dorsally without a median suture; head across eyes 342-362  $\mu$  wide. Horns with somewhat lumpy base, upper part smooth with sharp point, with about ten hairs, 4-8  $\mu$  long; length of horns 30-45  $\mu$ , 0.08-0.13 times as long as the width of the head across the eyes. Anterior to the eyes dorsally a transverse row of four hairs, the longest 70-75  $\mu$ ; anterior to this row 10-11 hairs, the longest 73-91  $\mu$ , and posterior to the eyes four hairs. Wax glands are lacking. Antennae with five segments, very pale brown, 415-470  $\mu$  long, 0.27-0.32 times as long as the body, 1.2-1.3 times the width of the head across the eyes, and 1.0-1.1 times as long as the tibia of the fore leg; length of antennal segments: III, 136-160  $\mu$ ; IV, 76-135  $\mu$ ; V, 105-125  $\mu$ , length of the processus terminalis 28-36  $\mu$ ; segment III is 1.2-1.8 times as long as IV, 1.3-1.7 times V, and 0.61-0.81 times IV plus V; segment IV is 0.7-1.1 times as long as V; segments I and II with some longitudinal ridges, the other segments somewhat wrinkled, and segment V with some spinulae. Eyes brown, with three ommatidia. Ultimate rostral segment 76-85  $\mu$  long, 0.72-0.80 times as long as the second tarsal segment of the hind leg; stylets 270-330  $\mu$  long.

**Thorax.**— Prothorax fused with the head, colourless, without wax glands, with a pleural groove on the posterior margin, proceeding forwards to the pleural muscle plate. Mesothorax with 0-2 marginal wax glands, metathorax without; both dorsally with four hairs, and with dotted or linear s-shaped wax glands. Legs very pale brown, smooth, but the second tarsal segments with some imbrications. Tibia of the fore leg 385-450  $\mu$  long, 1.1-1.2 times as long as the width of the head across the eyes. Chaetotaxy of first tarsal segments 4, 3, 2, length of hair of hind tarsus 25-31  $\mu$  long; second tarsal segment of the hind leg 99-106  $\mu$  long, 0.16-0.20 times as long as the



tibia of the hind leg, and 0.27-0.30 times as long as the width of the head across the eyes, with one dorsoapical hair 45-57  $\mu$  long with the tip slightly expanded, about two  $\mu$  wide, the other dorsoapical hair acute, 27-37  $\mu$  long. Empodial hairs of the hind leg 0-6  $\mu$  long. Length of segments of the hind leg: femur with trochanter 393-472  $\mu$ , tibia 535-618  $\mu$ , first tarsal segment 32-39  $\mu$ , second tarsal segment 99-106  $\mu$ ; the tibia is 1.30-1.36 times as long as the femur, and 1.1-1.3 times the width of the head across the eyes.

Abdomen.— Abdomen colourless, margins dorsally and tergites dotted, ventrally with linear s-shaped wax glands, or especially on distal segments with spinulose imbrications; number of marginal wax glands on each side: segment I, 0-2; II, 0-5; III, 0-6; IV, 0-5; V, 0-5; VI, 0-6; VII, 2-7. Number of hairs on tergites I-IV four, on V, 2-4; VI two; VII, 1-3; length of hairs dorsally on IV, 45-57  $\mu$ , ventrally, 40-51  $\mu$ . Tergite VIII with a transversely elongate very pale brown plate, e.g. 176  $\mu$  wide and 63  $\mu$  wide, with 11-15 oval wax glands, slightly squeezed flat against each other, arranged in an oval group, spinulose imbrications mainly observable ventrally, dorsally 6-9 hairs, 2-4 of which spinally on the wax gland plate, 50-61  $\mu$  long. All wax glands with facets. Siphunculi located on segment V, about 100  $\mu$  from the margins of the segment, a mere colourless ring, lacking the dots of the surrounding area, extending around the pore about 10  $\mu$ , without hairs; pore colourless, elevated above the surroundings about 10  $\mu$ , with a diameter of 43-50  $\mu$ . Cauda transversely elongate, a knob with a constriction e.g. 175  $\mu$  wide at the base, 55  $\mu$  long, the knob 90  $\mu$  wide, 25  $\mu$  long, and diameter of the constriction 40  $\mu$ ; the knob 88-100  $\mu$  wide, with 11-14 hairs, the longest 53-59  $\mu$ . Subanal plate bilobed, with 12-16 hairs, the longest 65-78  $\mu$ . Subgenital plate with 4-5 anterior hairs, the longest 33-40  $\mu$ , and 9-13 posterior hairs, the longest 30-40  $\mu$ . Gonapophyses two, each with 2-8 hairs, the longest 6-16  $\mu$ .

Alate viviparous female.— In life unknown.

Macerated specimens.— (figs. 260-263; described from 10 specimens). Body length 1.60-1.97 mm, 2.2-2.9 times as long as it is wide.

Head (fig. 260).— Head brown, dorsally smooth; width across the eyes 405-465  $\mu$ , dorsally anterior to the paired ocelli 12-17 hairs, posterior four or rarely five, 10-14  $\mu$  long; ventrally posterior to the median ocellus in all 14-18 hairs. Frons with two horns with rounded tip, 0-22  $\mu$  long, with 6-8 hairs on the horn or its location, about 2-4  $\mu$  long. Antennae brown with black rings, with five segments, 750-810  $\mu$  long, 0.38-0.46 times as long as the body, and 1.6-1.9 times the width of the head across the eyes; segment I somewhat wrinkled, segment II with longitudinal wrinkles and dorsally and ventrally with spinulose imbrications, the spinulae up to two  $\mu$  long; segments III-V with ring-shaped secondary rhinaria, the rings are not closed on the dorsal side, with an interval of 2-35  $\mu$ ; between the rhinaria are 3-5 concentric spinulose imbrications with dorsally and ventrally interconnections; the rhinaria are 2-4  $\mu$  wide. The primary rhinaria are between the annular rhinaria, and are moulded with these to a complex structure; segment III with 24-30 annular rhinaria, IV with 7-11, V with 7-10; hairs of segment III, 10-12  $\mu$  long. Length of segment III, 342-405  $\mu$ ; IV, 118-141  $\mu$ ; V, 126-153  $\mu$ , with the processus terminalis 18-25  $\mu$  long; segment III is 2.5-3.1 times as long as IV, 2.3-3.0 times V, and 1.2-1.5 times IV plus V; segment IV is 0.80-1.04 times as long as V. The last rostral segment is 72-82  $\mu$  long, 0.73-0.85 times as long as the second tarsal segment of the hind leg, without accessory hairs; length of stylets 260-310  $\mu$ . Eyes compound, the ocular tubercle extending sideways 20-25  $\mu$ .

Thorax.— Sides and dorsal side of prothorax partly pale brown, mesothorax brown. Fore wing (fig. 261) medial vein once branched, the hind wing with two oblique veins. Legs evenly rather pale brown, almost smooth but the second tarsal segments with some imbrications with a few spinulae; the tibia of the fore leg 450-492  $\mu$  long, 1.0-1.2 times as long as the width of the head across the eyes, longest hairs of the hind tibia 31-41  $\mu$ ; chaetotaxy of first tarsal segments 4, 3, 2, the lateral hairs about three times as long as the middle; length of hairs of the first tarsal segment of the hind leg 27-40  $\mu$ ; 0-1 dorsoapical hair of the second tarsal segment of the hind leg with expanded tip, 22-51  $\mu$  long, the other dorsoapical hair 18-20  $\mu$  long; length of the empodial hair of the hind leg 23-36  $\mu$ . Length of the hind segments: femur fused with trochanter 464-508  $\mu$ , tibia 598-677  $\mu$ , 1.2-1.4 times as long as the femur, and 1.4-1.6 times the width of the head across the eyes; first tarsal segment 37-41  $\mu$  long, second tarsal segment 93-100  $\mu$ .

Abdomen.— (fig. 262). Abdominal segments I-VI colourless, VII margins and dorsum very pale brown, VIII the posterior margin straight, pale brown, the sclerotic parts of the segments with indistinct spinulose imbrications; numbers of hairs on tergites I-IV about four, on tergite V usually four, VI and VII two or rarely three, VIII 5-10; length of hairs dorsally on segment IV, 18-24  $\mu$ , ventrally 23-29  $\mu$ ; on tergite VIII, 34-37  $\mu$ . Siphunculi located on segment V, a colourless indistinct ring, without hairs, the pore pale brown or colourless, 22-30  $\mu$  wide. Cauda (fig. 263) transversely elongate, e.g. 22  $\mu$  long, the knob 76  $\mu$  wide, and the diameter of the constriction 61  $\mu$ ; the knob is 68-85  $\mu$  wide, with 10-14 hairs, the longest 39-51  $\mu$ . Subanal plate bilobed, with 13-16 hairs, the longest 49-57  $\mu$ . Subgenital plate with 4-5 anterior hairs, the longest 37-45  $\mu$ , and 13-16 hairs along the posterior margin, the longest 31-39  $\mu$ . Gonapophyses two, each with 7-11 hairs, the longest 12-18  $\mu$ .

First stage larvae of apterae are of two types: normal larvae which will develop into adults, and "soldiers" (Aoki, Kurosu and Usuba, 1984; Aoki and Miyazaki, 1985) which do not develop into later stages, and are provided with giant horns and powerful raptorial fore legs. Both types are described below.

First stage larva, "normal" (fig. 264; description of one specimen): Body length 735  $\mu$ , length of head plus pronotum 208  $\mu$ , width of prothorax 251  $\mu$ , head across eyes 232  $\mu$  wide; the head dorsally with 10-12 anterior hairs and two rows of four hairs between the eyes, 65-70  $\mu$  long; ventrally on each side 5-6 hairs, the longest about 75  $\mu$ . Antennae with four segments, 255  $\mu$  long, segment III smooth, 106  $\mu$ ; IV, 77  $\mu$  with smooth imbrications, length of hair on segments II and III about 50  $\mu$ . Frons with two horns, pointed, smooth, 118  $\mu$  long, and 30  $\mu$  wide at the base, with 13-15 hairs, about four  $\mu$  long. Fore legs normal, the femur 220  $\mu$  long, and 47  $\mu$  wide in the middle, 0.95 times as long as the width of the head across the eyes. Tibia of the fore leg not curved at the basal part, 248  $\mu$  long; length of distal hairs of the hind tibia 50  $\mu$ . All first tarsal segments with two hairs, of the hind leg 40  $\mu$  long. Diameter of the base of the first tarsal segment of the fore leg 25  $\mu$ , 1.0 times as wide as that of the hind leg. Two dorsoapical hairs of the second tarsal segments without expanded tips, 84  $\mu$  long, the other apical hairs smaller. Marginal wax glands observable only on the posterior abdominal segments. Abdominal segments dorsal to the marginal wax glands with one hair, tergites I-IV with four hairs, V with three, VI and VII with two, VIII with two or three hairs, 34  $\mu$  long. Cauda with two hairs, 30  $\mu$  long. Siphunculi absent.

First stage larva, "soldier" (fig. 265; description of one specimen): Body length 945  $\mu$ , length of head plus pronotum 284  $\mu$ , width of prothorax 338  $\mu$ , head across eyes 322  $\mu$ ; the head dorsally with 10 anterior hairs, and between the eyes an anterior row of six hairs, and a posterior of four, 65  $\mu$  long; ventrally on each side 7-8 hairs, the longest 90  $\mu$ . Antennae with four segments, 381  $\mu$  long, segment III, 181  $\mu$ , with a few smooth imbrications; IV, 102  $\mu$ , with imbrications some with a few spinulae, length of hair on segments II and III about 42  $\mu$ . Frons with two horns, pointed, smooth, 240  $\mu$  long, and 55  $\mu$  wide at the base, with 18-19 hairs, about four  $\mu$  long, but one or two hairs at the base much longer. Fore legs brown, more sclerotic than the other legs which are colourless, and all segments and also the claws thicker and more sturdy; femur of the fore leg 425  $\mu$  long and 126  $\mu$  wide, 1.32 times as long as the width of the head across the eyes. Tibia of the fore leg curved, 378  $\mu$  long; length of distal hairs of the hind tibia 72  $\mu$  long. All first tarsal segments with two hairs, 30-42  $\mu$  long; diameter of the base of the first tarsal segment of the fore leg 33  $\mu$ , 1.4 times as wide as that of the hind leg. Two dorsoapical hairs of the second tarsal segments without expanded tips, the longest 84-94  $\mu$ , the lateral hairs shorter. Marginal wax glands observable on the posterior abdominal segments. Abdominal segments dorsal to the marginal wax glands with one hair, tergites I-V with four hairs, VI and VII with three and VIII with two, 43  $\mu$  long. Cauda with two hairs, 40  $\mu$  long. Siphunculi absent.

The embryos (figs. 266, 267) in the 16 alatae available are all similar to normal first stage larvae of apterae, but the horns are shorter, 27-47  $\mu$ , and wax glands are present on all segments of the body, on each side about: head 3-5, prothorax 4-5, mesothorax 7-9, metathorax 5-6, abdominal segment I, 3-4; II, 4-6; III, 5-6; IV, 6-7; V, 6-8; VI, 7-9; VII, 5-9, and VIII one group in the middle of 13-14. It may be assumed that new populations are started by first stage larvae of these alatae, and that the short horns, the many wax glands and the absence of soldiers are characteristics which distinguish them from first stage larvae of older populations.

Host plant records.— Specimens were collected in Java from bamboo, Linggadjati, 25.vii.1919, leg. P. van der Goot, in the collection at the Laboratorium voor Entomologie, Wageningen.

Alatae were collected 25.vii.1919.

Etymology.— *Floccifera*, bearing flocks of wool, the name Van der Goot intended to give to this species.

Discussion.— *C. floccifera* is rather like *C. longifila* (Takahashi, 1929) but has from prothorax to abdominal segment VII on each side groups of 14-17 large wax glands, and 15-30 glands on tergite VIII. Liao (1976) reports about the same numbers of wax glands, and so if no disappearance of glands occurs in *C. ongifila*, *C. floccifera* must be considered as another species.

***Ceratovacuna graminum* (Van der Goot, 1917) comb. nov.**  
(figs. 268, 269)

*Oregma graminum* Van der Goot, 1917: 184.

*Pseudoregma graminum*; Eastop & Hille Ris Lambers, 1974: 366 (classification).

The material collected by Van der Goot is lost, and no other collections from Java exist, but specimens collected in Vietnam (Szelegiewicz, 1968: 6, described as *Ceratovacuna? orientalis* Tak.) are assumed to be *C. graminum*; also used in the key characters of these Vietnam specimens present at the British Museum (Natural History), London. Data used in the description are from specimens from Vietnam and from Van der Goot (1917).

Apterous viviparous female.— In life: Body black or greyish black. Eyes, antennae, legs, siphunculi and cauda black. Wholly covered by a thin dense layer of wax.

Macerated specimens.— (fig. 268; described from five specimens): Body 1.83-2.07 mm (Van der Goot: 2.45 mm), 1.6-1.7 times as long as it is wide.

Head.— Head pale brown, smooth, usually with a median suture observable as a fine interrupted line, frons not protruding in the middle; head across the eyes 430-490  $\mu$  wide. Horns smooth with sharp points, 90-113  $\mu$  long (Van der Goot, 70  $\mu$ ), 0.18-0.25 times as long as the width of the head across the eyes, with 6-7 hairs, 4-6  $\mu$  long, longer basal hairs are lacking. The head with an anterior row of four interocular hairs, and a posterior row of four hairs, 65-76  $\mu$  long; anterior to these and dorsal to the horns 10-11 hairs. On each side a muscular plate and posterolateral to these sometimes a group of 1-3 wax glands, the glands with a diameter of about 10  $\mu$ . Antennae with five segments, pale brown, 280-320  $\mu$  long (Van der Goot: 410  $\mu$ ), 0.15-0.16 times as long as the body, 0.60-0.73 times the width of the head across the eyes; segments I-III almost smooth, IV and V with some spinulose imbrications; hairs on segment III, 22-26  $\mu$  long. Length of segment III, 58-65  $\mu$  long, 1.1-1.4 times as long as IV, 0.62-0.68 times as long as V (Van der Goot segment III as long as V); segment IV, 43-59  $\mu$  long, 0.48-0.61 times as long as V; segment V, 89-96  $\mu$  long, the processus terminalis 26-30  $\mu$ . Eyes brown, with three ommatidia. Last rostral segment 65-73  $\mu$  long, 0.51-0.56 times as long as the second tarsal segment of the hind leg; stylets 275-300  $\mu$  long.

Thorax.— Prothorax pale brown, fused with the head, and pleurally medial to the wax glands, at the posterior margin a groove 20-40  $\mu$  deep, connecting anteriorly with a large muscular plate; swellings on the pronotum are lacking; marginally on each side two hairs, dorsally 2-5 hairs; posteromarginally an oval group of 6-11 wax glands, the glands without conspicuous chitinous borders. Margins of the mesothorax pale brown, the dorsum with a pair of pale brown patches, with on each side an oval group of 4-13 wax glands, hard to observe, having no conspicuous borders, and being only slightly more opaque than the surroundings, with dots of about one  $\mu$ , not arranged in facets, the dorsum almost smooth, with 14-17 hairs. Metathorax with 4-13 marginal wax glands in an oval group, the metanotum with 14-17 hairs. Legs evenly pale brown, smooth, even the second tarsal segments usually without spinulae. Tibia of the fore leg 440-460  $\mu$  long, 0.91-0.95 times as long as the width of the head across the eyes; length of hairs of the hind tibia 53-61  $\mu$ . First tarsal segments with 3-4, 3, 2 hairs, and of the hind leg 57-69  $\mu$  long; second tarsal segment of the hind leg 0.21-0.22 times as long as the tibia of the hind leg, and 0.26-0.28 times as long as the width of the head across the eyes, with two dorsoapical hairs, 61-65  $\mu$  long, with expanded tips, 3-4  $\mu$  wide. Empodial hairs of the hind leg 38-42  $\mu$  long. Length of segments of the hind leg: femur with trochanter 460-492  $\mu$ , tibia 582-626  $\mu$ , first tarsal segment 47-51  $\mu$ , second tarsal segment 126-131  $\mu$ ; the tibia is 1.25-1.28 times as long as the femur.

Abdomen.— Abdomen colourless, but the marginal wax glands on oval very pale brown plates with spinulae at the outer border, more of these on the posterior segments; spinulose imbrications on tergites VI-VIII; linear s-shaped wax glands are lacking. Number of marginal wax glands on each side: segment I, 5-10; II, 9-13; III, 8-13; IV, 6-10; V, 5-11; VI, 8-17; VII, 12-17; diameter of the groups 70-160  $\mu$ . The glands are pale brown, with regularly distributed dots. Number of hairs on tergites, the marginal hair dorsal or lateral to the marginal wax glands not included: I, 15-19; II, 10-17; III, 8-12; IV, 8-15; V, 8-11; VI, 5-8; VII, 3-5; length of hairs dorsally on IV, 68-76  $\mu$ , ventrally 37-45  $\mu$ . Tergite VIII colourless with a transversely elongate pale brown plate with wax glands, e.g. 285  $\mu$  wide and 85  $\mu$  long, with 23-28 oval or roundish wax glands, slightly squeezed flat against each other; the surroundings of the wax gland plate with spinulose imbrications; with 7-9 hairs, two of which located spinally on the wax gland plate, 65-71  $\mu$  long. Siphunculi located dorsally on segment V, about 170  $\mu$  from the margins of the segment, a pale brown cone, extending outside the pore 10-15  $\mu$ , smooth with some concentric wrinkles, without hairs; pore brown, elevated above the base of the cone about 15  $\mu$ , with a diameter of 43-48  $\mu$ . Cauda transversely elongate, the base rather indistinct, e.g. 140  $\mu$  wide, a knob with a constriction, e.g. 30  $\mu$  long, 98  $\mu$  wide, and diameter of the constriction 50  $\mu$ ; the knob 80-98  $\mu$  wide, with 12-14 hairs, the longest 45-55  $\mu$ . Subanal plate bilobed, with 15-18 hairs, the longest 65-73  $\mu$ . Subgenital plate with 7-9 anterior hairs, the longest 51-63  $\mu$ , and 9-13 posterior hairs, the longest 45-60  $\mu$ . Gonapophyses two, each with 6-7 hairs, the longest 12-16  $\mu$ . Abdominal spiracles six, on segments II-VII.

Alate viviparous female.— (data Van der Goot, 1917). In life: Body, eyes, legs, siphunculi and cauda black. Pterostigma greyish black.

Macerated specimens.— Body length 2.80 mm, 2.4 times as long as it is wide. The head with two horns, with sharp tips, 20  $\mu$  long. Antennae with five segments, 900  $\mu$  long, 0.32 times as long as the body, segments III-V with ring-shaped secondary rhinaria, encircling almost the whole circumference, the primary rhinarium on segment V somewhat widened; segment III with 25-35 annular rhinaria, IV with 7-9 plus a primary rhinarium, V with 9-13 plus a primary and two accessory rhinaria; segment III, 2.5 times as long as IV, and 2.0 times as long as V; segment IV, 0.86 times as long as V. The cubitus and anal vein of the fore wing united at the base only. Characteristics of the rostrum, siphunculi etc. about the same as with apterous viviparous female.

First stage larva of apterous viviparous female (fig. 269; one specimen available). Body length about 700  $\mu$ , head across the eyes 240  $\mu$ ; length of hairs dorsally on the head 53  $\mu$ . Antennae with four segments, 175  $\mu$  long, segment III with a few spinulae, 59  $\mu$  long; IV, 78  $\mu$  with spinulose imbrications; length of hair on segment II, 50  $\mu$ , on III, 43  $\mu$ . Frons with two horns, pointed, smooth, 123  $\mu$  long, and 40  $\mu$  wide at the base, with 6-7 hairs, four  $\mu$  long. Fore legs normal, tibia of the fore leg 194  $\mu$  long, length of distal hairs of tibiae about 50  $\mu$ . All first tarsal segments with two hairs, 60-70  $\mu$  long. Two dorsoapical hairs of the second tarsal segment of the hind leg, 70-82  $\mu$  long, with expanded tips, the other apical hairs smaller and acute. Marginal wax glands on all segments of the body. Abdominal segments dorsal to the marginal wax glands with one hair, tergites I-V with four hairs, on the other segments not clear; length of hair on tergite IV, 45  $\mu$ ; on VIII, 37  $\mu$ . Cauda with two hairs, about 25  $\mu$  long. Siphunculi absent.

Host plant records.— Specimens were collected in Java: on a grass, presumably *Panicum spec.*, Kletak pass, Mt. Tengger (2000 m), early September 1913, leg. P. van der Goot (Van der Goot, 1917).

The aphids live on the lower side of the leaves.

Alatae were collected early September 1913.

Etymology— Graminum, of grasses, name given by Van der Goot (1917).

***Ceratovacuna keduensis* spec. nov.**

(figs. 270, 271)

Types.— Holotype (aptera vivipara) from bamboo leaf, Wonosobo, Java, Indonesia, 146-2-1, 20.iv.1916, leg. P. v.d. Goot, det. P. v.d. Goot: *Oregma keduensis*. Paratypes: four apterae viviparae, fragmentary, same locality, host plant and date as the holotype, leg. P. v.d. Goot, on seven slides. Holotype and paratypes in the collection at the Laboratorium voor Entomologie, Wageningen.

This aphid was collected by Van der Goot in 1916, and he described this species in his unpublished manuscript from which several data are borrowed for the next description.

Apterous viviparous female.— In life: Body dull black, the margins and two longitudinal rows along the dorsum with large, moderately short, whitish cones of a waxy secretion, which sometimes nearly obscure the original colour of the insect. Eyes black. Antennae and legs darkish grey. Siphunculi and cauda black.

Macerated specimens.— (fig. 270; described from four to seven specimens): Body length 1.61-1.74 mm (Van der Goot 2.07 mm), 1.6-1.7 times as long as it is wide.

Head.— Head pale brown, smooth, the frons straight, dorsally without a median suture; head across the eyes 350-397  $\mu$  wide. Horns somewhat lumpy, tapering, the tips sharp or blunt with about eight hairs, 6  $\mu$  long; length of horns 25-54  $\mu$ , 0.08-0.11 times as long as the width of the head across the eyes. Anterior to the eyes dorsally a transverse row of 7-10 hairs, the longest 45-63  $\mu$ . Wax glands medial to each eye in a group of 8-13; the glands are 18-32  $\mu$  in diameter, irregular circular or elliptical with a narrow chitinous border, the glands at a distance from each other of 4-10  $\mu$ ; the membrane of the glands is indistinctly reticulated; a group is about 155  $\mu$  long and 60  $\mu$  wide. Antennae with four segments, very pale brown, the last segment slightly darker, smooth, but the last segment with some spinulose imbrications, 360-397  $\mu$  long (Van der Goot, 450  $\mu$ ), 0.22-0.24 times as long as the body, 1.0 times the width of the head across the eyes, and 0.9-1.0 times as long as the tibia of the fore leg; length of antennal segments: III, 145-165  $\mu$ , 1.2-1.3 times as long as IV, length of IV, 120-127  $\mu$ . Eyes brown, with three ommatidia. Ultimate rostral segment 73-74  $\mu$  long, 0.63-0.70 times as long as the second tarsal segment of the hind leg; stylets 285-325  $\mu$  long.

Thorax.— Prothorax fused with the head, almost colourless, with on each side an area about 150  $\mu$  long, 65  $\mu$  wide with 6-10 wax glands; spinally two groups of 1-4 wax glands; pleurally at the posterior margin a groove, about 10  $\mu$  deep, proceeding forward to the pleural muscle plate, marginally on each side two hairs, dorsally two. Mesothorax almost colourless, slightly sclerotic with a distinct pleural groove, 8-10 marginal wax glands arranged in an oval group, and two spinal groups of 3-5 wax glands; mesonotum with 4-6 hairs, s-shaped wax glands are not observable.

Metathorax with 5-9 marginal wax glands arranged in an oval group, and two spinal groups each with 2-3 glands, s-shaped linear wax glands not observable, the metanotum with 4-7 hairs. Legs almost colourless, smooth, even the tarsi. Tibia of the fore leg 375-415  $\mu$  long, 1.1 times as long as the width of the head across the eyes. Chaetotaxy of first tarsal segments 4, 2-3, 2, hairs of the hind tarsus 40-41  $\mu$  long; second tarsal segment of the hind leg 0.18-0.19 times as long as the tibia of the hind leg, and 0.27-0.28 times the width of the head across the eyes, with two dorsoapical hairs, 50-59  $\mu$  long, with expanded tips, about three  $\mu$  wide. Empodial hairs of the hind leg 20-23  $\mu$  long. Length of the segments of the hind leg: femur with trochanter 397-417  $\mu$ , tibia 567-630  $\mu$ , 1.4-1.5 times as long as the femur, first tarsal segment 41-47  $\mu$ , second tarsal segment 103-116  $\mu$ .

Abdomen.— Abdomen colourless, but the wax glands on almost colourless plates, no linear s-shaped wax glands observable, some spinulose imbrications only ventrally on segment VII. Wax glands as on head and thorax in oval groups, the glands at a distance from each other of 2-10  $\mu$ , irregular circular or elleptical, rarely with one or two flat margins, the membrane of the glands indistinctly reticulated, the glands with a diameter of 30-50  $\mu$ ; number of marginal glands on each side: segment I, 3-6; II, 4-6; III, 4-6; IV, 3-5; V, 4-6; VI, 5-7; VII, 5-8; spinally two groups each with on segment I, 3-5 glands; II, 3-5; III, 3-6; IV, 2-5; V, 3-6; VI, 2-4; VII zero. Number of hairs on tergites I-V, one hair dorsal to the wax gland not included, 4-6, of which 2-4 spinally between the spinal wax glands; length of hairs dorsally on IV, 36-55  $\mu$ , ventrally 30-45  $\mu$ . Tergite VIII with a transversely elongate almost colourless plate, e.g. 235  $\mu$  wide and 95  $\mu$  long, with some spinulose imbrications along the borders, with 11-14 oval or roundish wax glands, slightly squeezed flat against each other, but still 4-8  $\mu$  removed from each other; with 4-8 hairs, 1-3 of which spinally and 57-62  $\mu$  long. Siphunculi located on segment V, the pore about 100-125  $\mu$  from the margins of the segment, a very pale brown ring with some concentric wrinkles extending around the pore 10-20  $\mu$ , without hairs; pore brown, elevated above the ring about 25  $\mu$ , with a diameter of 45-48  $\mu$ . Cauda transversely elongate, e.g. 106  $\mu$  wide and 25  $\mu$  long; the knob 84-108  $\mu$  wide, with 10-14 hairs, the longest 45-63  $\mu$ . Subanal plate bilobed, with 16-21 hairs, the longest 47-69  $\mu$ . Subgenital plate with 3-4 anterior hairs, the longest 50-60  $\mu$ , and 7-8 posterior hairs, the longest 30-35  $\mu$ . Gonapophyses two, each with 4-6 hairs, the longest 10-12  $\mu$ .

Alate viviparous female.— In life: Body dull black. Eyes, antennae etc. black. Pterostigma of fore wing blackish.

Macerated specimens.— (described from fragments of a few specimens). Body length 1.97-2.20 mm, 1.8-2.2 times as long as it is wide. Length of hairs dorsally on the head 30  $\mu$ . Horns four  $\mu$  long or absent. Antennae usually with four segments, but sometimes with five, 735-900  $\mu$  long. In antennae with four segments: III, 470-500  $\mu$  long, 2.6-3.1 times as long as IV, with 40-45 annular rhinaria; IV, 160-180  $\mu$  long with the processus terminalis 25-29  $\mu$  long, with 10-14 annular rhinaria. In antennae with five segments III with 30 annular rhinaria, 3.4 times as long as IV, 2.2 times as long as V, and IV, 0.65 times as long as V; V with 14 annular rhinaria. Last rostral segment 68-74  $\mu$  long, 0.68 times as long as the second tarsal segment of the hind leg. Length of hairs on tergite IV, 30-35  $\mu$ , tergite VIII with about eight hairs, 37-41  $\mu$  long. Siphunculi a brown pore only 33-40  $\mu$  wide, with some concentric wrinkles around, not more than four  $\mu$  from the outer margin of the pore. Cauda 78-108  $\mu$

wide, with 12 hairs, the longest 35-45  $\mu$ . Subanal plate bilobed with 18-19 hairs. Subgenital plate with four anterior hairs, 43  $\mu$  long, and 9-11 posterior hairs, 43  $\mu$  long. Gonapophyses two with 7-8 hairs, 14-18  $\mu$  long.

First stage larva (fig. 271) of apterous viviparous female (description of one specimen): Body length 685  $\mu$ , length of head plus pronotum 214  $\mu$ , width of the prothorax 283  $\mu$ , the head across the eyes 236  $\mu$ ; the head dorsally with four hairs, and two rows of four hairs, about 40  $\mu$  long. Antennae with four segments, 236  $\mu$  long, segment III with a few imbrications with some spinulae, 77  $\mu$  long, IV with spinulose imbrications, 92  $\mu$  long; length of a hair on segment II, 33  $\mu$ , on III, 28  $\mu$ . Frons with two horns, pointed, smooth, 96  $\mu$  long and 48  $\mu$  wide at the base, with hairs about six  $\mu$  long. Tibia of the fore leg 244  $\mu$  long, length of distal hairs of tibiae 50-60  $\mu$  long. All first tarsal segments with two hairs, about 75  $\mu$  long. Two apical hairs of the second tarsal segment of the fore leg with expanded tips, 70  $\mu$  long, the other apical hairs smaller and acute. Marginal wax glands on all thoracic and abdominal segments, spinal wax glands in two rows on the head, thoracic segments and abdominal segments I-VI, lacking on segment VII, and present on VIII in a transversely elongate area. Marginal wax glands on the prothorax 7-9, mesothorax 7-8, metathorax 5-6, abdominal segments I-VII, 3-6; spinal wax glands on the head in each group 8-11, prothorax two, mesothorax 3-4, metathorax 2-3, abdominal segment I, 3-4; II four; III, 4-5; IV, 2-4; V, 3-4; VI, 2-3; and VIII, 8-13. Abdominal segments dorsal to the marginal wax glands with one hair, tergites I-V usually with four hairs, VI-VIII with two, about 27  $\mu$  long. Cauda with two hairs, 44  $\mu$  long. Siphunculi absent.

Host plant records.— Specimens were collected in Java on bamboo by P. van der Goot: Wonosobo, 700 m, 20.iv.1916, Mt. Merbaboe (800-1400 m), Garoet (700 m), Tjiparay (1000 m), Mt. Papandajan (1350 m). Specimens collected at Wonosobo, no. 146 are in the collection at the Laboratorium voor Entomologie, Wageningen.

The aphids live on the lower side of leaves, often very numerous, excreting a large quantity of honeydew which causes growth of sooty moulds on lower leaves.

Alatae were collected in 1916 from April to August.

Etymology.— *Keduensis*, from Kedu, a region of Middle Java where the aphid was collected; Van der Goot refers to the aphid in his manuscript as *keduensis*.

### *Ceratovacuna lanigera* Zehntner, 1897

*Ceratovacuna lanigera* Zehntner, 1897: 29.

*Oregma lanigera*; Van der Goot, 1917: 190.

Apterous viviparous female.— In life (pl. 28): Head brownish yellow or greyish brown, sometimes the hind border with green. Abdomen pale yellow with pale brown spots or stripes, along the segmental borders sometimes some green. Antennae yellow, the last segment grey. Siphunculi a narrow brown ring. Eyes black. Head, antennae and legs with some granular wax, the rest of the body with a thick cushion of wax, and especially the margins and the back of the body with thick curling white threads. Larvae when young yellow with a thin layer of wax, the borders of the segments without wax, gradually more wax especially at the margins.

Macerated specimens.— (fig. 272; described from 10 specimens): Body 1.87-2.45



mm long, 1.4-1.7 times as long as it is wide.

Head.— Head frons and margins to the eyes pale brown, the central area very pale brown or colourless, smooth, with a median suture, observable as a colourless line; frons protruding in the middle 0.8  $\mu$ ; head across the eyes 460-550  $\mu$  wide. Horns with a somewhat lumpy base, upper part smooth with sharp points, with about eight hairs, 6-8  $\mu$  long, but one hair may be longer, up to 50  $\mu$ ; length of horns 65-88  $\mu$ , 0.12-0.18 times as long as the width of the head across the eyes. Anterior to the eyes dorsally a transverse row of 4-6 hairs, the longest 58-76  $\mu$ ; anterior to this row 5-9 hairs, and posterior to that row 4-5 hairs. Wax glands medial to the eyes number on each side 0-2, the glands with a diameter of 14-27  $\mu$ . Antennae with five segments, pale brown, the last segment sometimes darker, 250-365  $\mu$  long, 0.12-0.17 times as long as the body, 0.51-0.69 times the width of the head across the eyes, and 0.7-0.8 times as long as the tibia of the fore leg; length of antennal segments: III, 60-97  $\mu$ ; IV, 35-71  $\mu$ ; V, 63-104  $\mu$ ; the processus terminalis 25-35  $\mu$  long; segment III is 1.2-2.0 times as long as IV, 0.75-1.1 times as long as V, and 0.47-0.67 times as long as IV plus V; segment IV is 0.50-0.79 times as long as V; segments I and II with some longitudinal ridges, the other segments somewhat wrinkled and segments IV and V with some spinulose imbrications, mainly on the ventral side; hairs on segment III, 20-48  $\mu$  long. Eyes brown, with three ommatidia. Ultimate rostral segment 55-71  $\mu$  long, 0.47-0.55 times as long as the second tarsal segment of the hind leg; stylets 225-280  $\mu$  long.

Thorax.— Prothorax fused with the head, the lateral margins pale brown, the pronotum colourless, with on each side 0-6 wax glands. At the posterior margin an indistinct groove is sometimes pleurally observable. Margins of the mesothorax very pale brown, with 0-9 wax glands, sometimes arranged in an oval group, and then the oval or roundish glands somewhat squeezed flat against each other; the glands are hard to observe, having no chitinous border, and being only slightly more opaque than the surrounding area, with dots of less than one  $\mu$  distributed regularly over the surface, not arranged in facets. Mesonotum with linear s-shaped wax glands, and with 4-9 hairs. Metathorax with 0-5 marginal wax glands arranged in an almost colourless oval group; the margins ventrally and dorsally, and the metanotum all over with linear s-shaped wax glands, more or less arranged in bands; metanotum with 4-7 hairs. Legs almost evenly brown or pale brown, smooth, even the tarsi. Tibia of the fore leg 355-470  $\mu$  long, 0.74-0.86 times as long as the width of the head across the eyes. Chaetotaxy of first tarsal segments 2-4, 2-3, 2, hairs of hind tarsus 50-65  $\mu$  long; second tarsal segment of the hind leg 0.18-0.21 times as long as the tibia of the hind leg, and 0.23-0.26 times as long as the width of the head across the eyes, with two dorsoapical hairs, 51-67  $\mu$  long, with expanded tips 2-3  $\mu$  wide. Empodial hairs of the hind leg 27-33  $\mu$  long. Length of segments of the hind leg: femur with trochanter 484-519  $\mu$ , tibia 614-693  $\mu$ , first tarsal segment 47-50  $\mu$ , second tarsal segment 123-132  $\mu$ ; the tibia is 1.23-1.35 times as long as the femur, and 1.2-1.3 times the width of the head across the eyes.

Abdomen.— Abdomen colourless, but the marginal wax glands, if present, on oval very pale brown plates; margins and dorsal side of segments I-VII with linear s-shaped wax glands, the ventral side with spinulose imbrications; number of marginal wax glands on each side: segment I, 0-5; II, 0-6; III, 0-8; IV, 0-7; V, 0-5; VI, 0-9; VII, 0-9. Number of hairs on tergite I, 5-7; II, 4-7; III, 5-7; IV, 6-9; V, 6-8; VI, 2-4; VII two, or sometimes three; length of hairs dorsally on IV, 53-78  $\mu$ , ventrally 42-59  $\mu$ .

Tergite VIII with a transversely elongate pale brown plate, e.g. 300  $\mu$  wide and 90  $\mu$  long, with 16-27 oval or roundish wax glands, slightly squeezed flat against each other; the surroundings of the plate with spinulose imbrications; with 6-9 hairs, two of which located spinally on the wax gland plate, 45-71  $\mu$  long. All wax glands with regularly distributed dots. Siphunculi located on segment V, dorsally, about 150  $\mu$  from the margins of the segment, a mere pale brown ring extending around the pore 6-12  $\mu$ , without hairs; pore brown, elevated above the surroundings about 10  $\mu$ , with a diameter of 48-63  $\mu$ . Cauda transversely elongate, a knob with a constriction, e.g. 50  $\mu$  long, the knob 118  $\mu$  wide, and a diameter of the constriction 70  $\mu$ ; the knob 106-126  $\mu$  wide, with 13-19 hairs, the longest 69-80  $\mu$ . Subanal plate bilobed, with 19-23 hairs, the longest 72-84  $\mu$ . Subgenital plate with 3-5 anterior hairs, the longest 45-53  $\mu$ , and 9-20 posterior hairs, the longest 43-51  $\mu$ . Gonapophyses two, each with 5-8 hairs, the longest 14-22  $\mu$ .

Alate viviparous female.— In life: Wholly black. Pterostigma grey, fore wing at the base somewhat greenish. Without wax. Last stage larvae brownish, abundant with wax (except the head and mesothorax) with thick threads of wax, sometimes as long as the body.

Macerated specimens.— (figs. 273-277; described from 11 specimens). Body length 1.97-2.57 mm, 1.9-2.2 times as long as it is wide.

Head.— (fig. 273). Head blackish brown, dorsally smooth with blunt spinulae of about one  $\mu$  diameter, the frons and close to the paired ocelli slightly wrinkled; width across the eyes 470-530  $\mu$ , dorsally anterior to the paired ocelli 6-8 hairs, posterior also 6-8 hairs, 14-23  $\mu$  long; ventrally posterior to the median ocellus in all 9-16 hairs, 4-8 on each side. Frons with two horns with sharp or rounded tips, 15-25  $\mu$  long, with 6-8 hairs on the horn and close to the base about 6-7  $\mu$  long. Antennae brown with black rings, with five segments, 455-670  $\mu$  long, 0.20-0.29 times as long as the body, and 0.9-1.3 times the width of the head across the eyes; segment I somewhat wrinkled, segment II with longitudinal wrinkles and spinulose imbrications, slightly more on the ventral side, the spinulae up to two  $\mu$  long; segments III-V with ring-shaped secondary rhinaria, the rings are not closed on the dorsal side, with a space of 5-30  $\mu$ ; between the rhinaria are 3-5 or on the last segment even more concentric spinulose imbrications, dorsally and ventrally with interconnections; the rhinaria are 2-4  $\mu$  wide. The primary rhinaria are between the annular rhinaria, and are moulded with them to a complex structure; segment III with 16-25 annular rhinaria, IV with 5-10, V with 2-9; hairs of segment III, 8-18  $\mu$  long. Length of segment III, 214-287  $\mu$ ; IV, 80-135  $\mu$ ; V, 89-150  $\mu$ , with the processus terminalis 16-33  $\mu$  long; segment III is 2.2-2.8 times as long as IV, 1.8-2.6 times as long as V, and 1.0-1.3 times as long as IV plus V; segment IV is 0.83-1.04 times as long as V. The last rostral segment is 58-73  $\mu$  long, 0.49-0.59 times as long as the second tarsal segment of the hind leg, without accessory hairs; length of stylets 245-285  $\mu$ . Eyes compound, the ocular tubercle extending sideways about 20  $\mu$ .

Thorax.— Sides and partly the middle area of the prothorax brown, mesothorax dark brown. Fore wing (fig. 274) medial vein once branched, the hind wing with two oblique veins. Legs brown, the distal end of the femur and the base of the tibia dorsally darker, the femora and second tarsal segments with some not very distinct spinulose imbrications, the tibiae almost smooth; the tibia of the fore leg 456-660  $\mu$  long, 1.0-1.2 times as long as the width of the head across the eyes, longest hairs of

the hind tibia 35-48  $\mu$ ; chaetotaxy of first tarsal segments usually 4, 3, 2, the lateral hairs 2-3 times as long as the middle; length of hairs of the first tarsal segment of the hind leg 24-33  $\mu$ ; one dorsoapical hair of the second tarsal segment of the hind leg with expanded tip, 55-65  $\mu$  long, the tip about three  $\mu$  wide; length of the empodial hair of the hind leg 27-35  $\mu$ . Length of the hind segments: femur fused with trochanter 480-602  $\mu$ , tibia 612-881  $\mu$ , 1.3-1.5 times as long as the femur, and 1.3-1.7 times the width of the head across the eyes; first tarsal segment 39-49  $\mu$  long, second tarsal segment 111-128  $\mu$ .

Abdomen.— (fig. 275). Abdominal segments I-V colourless, the dorsum of VI sometimes with some small indistinct very pale brown spots, VII margins and dorsum pale brown, VIII the posterior margin straight or somewhat emarginate, pale brown, all sclerotic parts of the segments with spinulose imbrications; numbers of hairs on tergites I-IV about 5-10, on tergite V, 4-9; VI, 4-5; VII two; VIII, 7-9; length of hairs dorsally on segment IV, 25-45  $\mu$ , ventrally 22-43  $\mu$ , on tergite VIII, 27-55  $\mu$ . Siphunculi (fig. 276) located on segment V, pale brown, a ring about 5  $\mu$  high, sometimes surrounded by some concentric wrinkles, without hairs, diameter of the pore 35-48  $\mu$ . Cauda (fig. 277) transversely elongate, e.g. 40  $\mu$  long, the knob 124  $\mu$  wide, and diameter of the constriction 80  $\mu$ ; the knob is 106-126  $\mu$  wide, with 15-19 hairs, the longest 60-78  $\mu$ . Subanal plate bilobed, with 22-28 hairs, the longest 61-90  $\mu$ . Subgenital plate with 13-19 anterior hairs (on the plate), the longest 37-57  $\mu$  and 10-16 hairs along the posterior margin, the longest 41-60  $\mu$ . Gonapophyses two, each with 8-10 hairs, the longest 14-24  $\mu$ .

First stage larva (fig. 278) of apterous viviparous female (measures presented for one specimen): Body length 880  $\mu$  (other specimens 700-950  $\mu$ ), length of head plus pronotum 267  $\mu$ , width of prothorax 346  $\mu$ , head across eyes 295  $\mu$  wide (other specimens 248-305  $\mu$ ), dorsally with 5-8 anterior hairs and two rows of four hairs between the eyes, about 55  $\mu$  long; ventrally on each side 4-5 hairs, the longest about 70  $\mu$  long. Antennae with four segments, 205  $\mu$  long, segment III, 71  $\mu$ ; IV, 78  $\mu$ , both with spinulose imbrications; length of hair on segment II, 25  $\mu$ , on III, 40  $\mu$ . Frons with two horns, pointed, smooth, 140  $\mu$  long, and 70  $\mu$  wide at the base, with hairs, 4-10  $\mu$  long. Tibia of the fore leg 260  $\mu$  long, length of distal hairs of tibiae about 55  $\mu$  long. All first tarsal segments with two hairs, about 60  $\mu$  long. Two dorsoapical hairs of the second tarsal segment of the hind leg with a blunt or slightly expanded tip, 80  $\mu$  long, the other apical hairs smaller and acute. Marginal wax glands on all segments of the body, or only present on the posterior abdominal segments. Abdominal segments dorsal to the marginal wax glands with one hair, tergites I-V each with usually four hairs, VI with 3-4, VII and VIII with two, 40-50  $\mu$  long. Cauda with two hairs about 35  $\mu$  long. Siphunculi present, diameter of the pore about 27  $\mu$ .

The embryos in alatae of one collection are similar to first stage larvae of apterae, with horns and siphunculi; the abdomen of these alatae contain many embryos, about 10-15. Seven alatae in collection no. 975 differ from others by relatively short antennae, 0.20-0.25 times the length of the body, and antennal segment V with only 2-4 linear rhinaria; the abdomen of these alatae contains only about four embryos which are without horns, presumably without siphunculi, and without groups of wax glands.

Host plant records.— Zehntner (1898) mentions as host plants *Saccharum officinarum* L. and *S.spontaneum* L. on Java. Specimens were collected in Java from *S.offici-*

*narum* in the places and on the dates indicated, while the collectors are indicated by numbers between parentheses: Van der Goot (1917), (1); F.W. Rappard (2), and P. Büchner (3), both in the collection at the British Museum (Natural History), London; D. Noordam (4), in the collection at the Rijksmuseum van Natuurlijke Historie, Leiden. Pasoeroean, Poespo (700 m) (1); Amboeloe, South-Djember (50 m), 23.xi.1949 (2); Badean, Djember (200 m), 13.xi.1950 (2); Bogor, 1.vi.30.vii.1956 (3); Sindanglaya (1100 m), 19.v.1975 (4); Jakarta, 10.vii.1977 (4).

The aphids live mainly on the lower side of leaves very densely crowded, sometimes (Dr F.W. Rappard, unpublished) also here and there on the upper side of leaves, on sheaths, and young stems.

Alatae were collected 13.xi.1950, 19.v.1975 and 10.vii.1977, and Van der Goot (1917) writes that alatae occur during the dry as well as during the rainy season, so about in July as well as in January.

Etymology.— Zehntner (1898) gave the name *lanigera*, wool bearing.

***Ceratovacuna panici* (Van der Goot, 1917)**  
(figs. 279 - 284)

*Oregma panici* Van der Goot, 1917: 214.

*Ceratovacuna panici*; Eastop & Hille Ris Lambers, 1976: 131.

Types.— Lectotype (aptera vivipara, here designated) from grass, Songoriti, VI-1914, leg. P. v.d. Goot, no. 64-1-2, det. P. v.d. Goot: *Oregma panici*. Paralectotypes: 25 apterae viviparae and five alatae viviparae, fragmentary on eight slides with data as the lectotype and no. 19 with data: *Panicum* spec., Songoriti, 24.vi.1914, leg. P. v.d. Goot, det. P. v.d. Goot: *Oregma* spec. Lectotype and paralectotypes in the collection at the Laboratorium voor Entomologie, Wageningen.

Apterous viviparous female.— In life (pl. 29): Yellow or somewhat brownish, the cauda and distal part of the abdomen more yellow, the borders of the segments a yellow line. Antennae yellow, distally somewhat grey. Legs yellowish. Eyes black. Body densely covered with wax, like snow flakes, the borders of the segments remain visible rather a long time. Borders of the body with compact columns of wax, shorter than sometimes in *C.lanigera*. Larvae yellow with distinct transverse lines between the wax on the segments.

Macerated specimens.— (fig. 279; described from 11 specimens): Body 1.54-1.84 mm long, 1.4-1.8 times as long as it is wide.

Head.— Head very pale brown, the central area almost colourless, smooth, with a median suture, observable as a fine interrupted line, frons not protruding in the middle; head across the eyes 340-425  $\mu$  wide. Horns smooth with sharp point, with 5-8 hairs, hairs at the tips 6-8  $\mu$  long, basal hairs 10-45  $\mu$  long; length of horns 50-63  $\mu$ , 0.14-0.17 times as long as the width of the head across the eyes. Head dorsally with 4-7 anterior hairs, the longest 55-81  $\mu$ ; four anterior interocular hairs, and four posterior. Wax glands medial to the eyes number on each side 0-4, the glands with a diameter of 14-40  $\mu$ . Antennae with four or five segments, very pale brown or almost colourless, 220-330  $\mu$  long, 0.14-0.20 times as long as the body, 0.63-0.81 times the width of the head across the eyes, and 0.7-0.9 times as long as the tibia of the fore leg;

in four-segmented antennae III with some smooth imbrications, IV with some spinulose imbrications, in five-segmented antennae IV and V with some spinulose imbrications; hairs on III, 23-59  $\mu$  long; length of segments in four-segmented antennae: III, 75-125  $\mu$ ; IV, 69-98  $\mu$ ; III is 1.0-1.3 times as long as IV; in five-segmented antennae length of III, 55-70  $\mu$ ; IV, 45-60  $\mu$ ; V, 85-100  $\mu$ ; III is 1.1-1.3 times as long as IV, 0.65-0.74 times as long as V, and 0.41-0.46 times as long as IV plus V; IV is 0.50-0.65 times as long as V. Eyes brown, with three ommatidia. Ultimate rostral segment 54-65  $\mu$  long, 0.45-0.59 times as long as the second tarsal segment of the hind leg; stylets 205-240  $\mu$  long.

Thorax.— Prothorax very pale brown or colourless, fused with the head, and pleurally medial to the wax glands at the posterior margin with a groove 6-25  $\mu$  deep, but swellings on the pronotum lacking; marginally on each side two hairs, dorsally 2-4; posteromarginally an oval group of 0-9 wax glands. Margins of the mesothorax very pale brown, the dorsum almost colourless, with 1-14 marginal wax glands arranged in an oval group, the glands oval somewhat squeezed flat against each other; the glands are hard to observe, having no chitinous border, and being only slightly more opaque than the surroundings, with dots of about one  $\mu$  distributed regularly over the surface, not arranged in facets; mesonotum with linear s-shaped wax glands, and with 4-5 hairs. Metathorax with 0-9 marginal wax glands, arranged in an oval group, the margins and the metanotum with rather indistinct linear s-shaped wax glands, the metanotum with 4-5 hairs. Legs evenly pale brown, almost smooth, even the tarsi. Tibia of the fore leg 251-460  $\mu$  long, 0.72-1.1 times as long as the width of the head across the eyes; length of hairs of the hind tibia 53-65  $\mu$ . Chaetotaxy of first tarsal segments 2-4, 2-3, 2, length of hair on hind tarsus 47-65  $\mu$ ; second tarsal segment of the hind leg 0.19-0.26 times as long as the tibia of the hind leg, and 0.26-0.30 times as long as the width of the head across the eyes, with two dorsoapical hairs, 52-59  $\mu$  long, with expanded tips, about three  $\mu$  wide. Empodial hairs of the hind leg 28-36  $\mu$  long. Length of the segments of the hind leg: femur with trochanter 327-464  $\mu$ , tibia 385-626  $\mu$ , first tarsal segment 39-44  $\mu$ , second tarsal segment 92-122  $\mu$ ; the tibia is 1.15-1.35 times as long as the femur.

Abdomen.— Abdomen colourless, but the marginal wax glands, if present, on oval very pale brown plates; margins and dorsal side of segments I-VI with linear s-shaped wax glands; on the ventral side and also partly on tergite VII with spinulose imbrications; number of marginal glands on each side: segment I, 0-6; II, 0-9; III, 0-10; IV, 0-11; V, 0-10; VI, 0-17; VII, 0-11. Number of hairs on the tergites, the hair dorsally to the marginal wax glands not included: I, 4-5; II, 3-5; III, 3-6; IV, 4-6; V, 2-6; VI, 2-4; VII two; length of hairs dorsally on IV, 59-85  $\mu$ , ventrally 33-55  $\mu$ . Tergite VIII with a transverse elongate pale brown plate, e.g. 200  $\mu$  wide and 80  $\mu$  long, with 5-20 oval or roundish wax glands, slightly squeezed flat against each other; the surroundings of the plate with spinulose imbrications; with 5-9 hairs, two of which located spinally on the wax gland plate, 48-74  $\mu$  long. All wax glands with regularly distributed dots. Siphunculi located dorsally on segment V, about 100-200  $\mu$  from the margins of the segment, a very pale brown ring extending around the pore 6-10  $\mu$ , without hairs; pore brown, elevated above the ring less than 10  $\mu$ , with a diameter of 40-45  $\mu$ . Cauda transversely elongate, a knob with a constriction, e.g. 37  $\mu$  long, the knob 105  $\mu$  wide, and diameter of the constriction 70  $\mu$ ; the knob 88-106  $\mu$  wide, with 10-17 hairs, the

longest 57-70  $\mu$ . Subanal plate bilobed, with 12-15 hairs, the longest 65-70  $\mu$ . Subgenital plate with four anterior hairs, the longest 34-57  $\mu$ , and 6-11 posterior hairs the longest 25-53  $\mu$ . Gonapophyses two, each with 4-8 hairs, the longest 12-22  $\mu$ . Abdominal spiracles six, on segments II-VII.

Alate viviparous female.— In life: Head black, thorax black or brown, abdomen yellow, marbled brown or wholly dark; cauda yellow. Pterostigma grey or black. Antennae black. Legs brownish, without wax. Last stage larvae brownish, with wax, except on the head and mesothorax.

Macerated specimens.— (figs. 280-283; described from seven specimens). Body length 2.07-2.27 mm, 2.0-2.5 times as long as it is wide.

Head.— (fig. 280). Head black, dorsally smooth with blunt spinulae of about one  $\mu$  diameter, the frons and near the paired ocelli slightly wrinkled; width across the eyes 430-520  $\mu$ , anterior to the paired ocelli five hairs, posterior 6-8, 30-35  $\mu$  long. Frons with two horns with rounded tips, 0-20  $\mu$  long, with 4-7 hairs on the horn or its location, about 6-10  $\mu$  long. Ventrally, posterior to the median ocellus, 6-9 hairs on each side. Antennae brown, with black rings, with five segments, 570-870  $\mu$  long, 0.26-0.41 times as long as the body, and 1.1-1.9 times the width of the head across the eyes; segment I somewhat wrinkled, segment II with a few longitudinal wrinkles, and dorsally and ventrally with spinulose imbrications, the spinulae up to two  $\mu$  long; segments III-V with ring-shaped secondary rhinaria, the rings are not closed on the dorsal side, with a space of 2-35  $\mu$ ; between the rhinaria are 3-5 concentric spinulose imbrications, dorsally and ventrally with interconnections; the rhinaria are 2-3  $\mu$  wide. The primary rhinaria are between the annular rhinaria and are moulded with them to a complex structure; segment III with 17-30 annular rhinaria, IV with 7-15, V with 6-14; hairs of segment III, 12-16  $\mu$  long. Length of segment III, 235-395  $\mu$ ; IV, 105-180  $\mu$ ; V, 130-180  $\mu$ , with a processus terminalis 15-19  $\mu$  long; segment III is 1.9-2.4 times as long as IV, 1.8-2.4 times as long as V, and 0.9-1.2 times as long as IV plus V; segment IV is 0.79-1.14 times as long as V. The last rostral segment is 65-78  $\mu$  long, 0.56-0.66 times as long as the second tarsal segment of the hind leg, without accessory hairs; length of the stylets 230-290  $\mu$ . Eyes compound, the ocular tubercle extending sideways about 25  $\mu$ .

Thorax.— Sides and partly the middle area of the prothorax brown, the mesothorax dark brown. Forewing (fig. 281) medial vein once branched, the hind wing with two oblique veins. Legs brown, the distal end of the femur and the base of the tibia dorsally darker, the femora and second tarsal segments with some not very distinct spinulose imbrications; the tibia of the fore leg 538-598  $\mu$  long, 1.1-1.4 times as long as the width of the head across the eyes, length of hairs of the hind tibia 31-39  $\mu$ ; chaetotaxy of first tarsal segments 3-4, 3, 2, the lateral hairs about three times as long as the middle hair; length of hairs on the first tarsal segment of the hind leg 31-39  $\mu$ ; one dorsoapical hair of the second tarsal segment of the hind leg with expanded tip, 51-55  $\mu$  long, the tip about three  $\mu$  wide; length of the empodial hair of the hind leg 34-40  $\mu$ . Length of the hind segments: femur fused with trochanter 504-535  $\mu$ , tibia 708-740  $\mu$ , 1.4 times as long as the femur, and 1.1-1.2 times the width of the head across the eyes; first tarsal segment 35-41  $\mu$  long, second tarsal segment 113-121  $\mu$ .

Abdomen.— (fig. 282). Abdominal segments I-V colourless, the tergite of VI with some pale brown spots or with a transverse band, VII margins and dorsum pale

brown, VIII the posterior margin emarginate 25-40  $\mu$ , pale brown, but the lateral margins paler, alle sclerotic parts of the segments with spinulose imbrications; number of hairs on tergites I-IV about 4-5; on tergite V, 2-4; VI, 4-5; VII two; VIII, 6-8; length of hairs dorsally on segment IV, 40-45  $\mu$ , ventrally 31-40  $\mu$ , on tergite VIII, 43-53  $\mu$ . Siphunculi (fig. 283) located on segment V, pale brown, an asymmetrical ring around the pore, about 5  $\mu$  high and at its widest part 5-10  $\mu$  wide, without hairs, diameter of the pore 33-40  $\mu$ . Cauda transversely elongate, e.g. 143  $\mu$  wide at the base, the knob 102  $\mu$  wide, 46  $\mu$  long, and diameter of the constriction 74  $\mu$ ; the knob is 88-102  $\mu$  wide, with 12-20 hairs, the longest 68-72  $\mu$ . Subanal plate bilobed, with 13-19 hairs, the longest 67-74  $\mu$ . Subgenital plate with 11-13 anterior hairs (on the plate), the longest 41-48  $\mu$ , and 12-15 hairs along the posterior margin, the longest 39-45  $\mu$ . Gonapophyses two, each with 6-11 hairs, the longest 16-22  $\mu$ . Spiracles on six abdominal segments, II-VII.

First stage larva of apterous viviparous female (fig. 284; description usually of one specimen): Body length 625  $\mu$  (600-1075  $\mu$ ), length of head plus pronotum 196  $\mu$ , width of prothorax 271  $\mu$ , head across eyes 240  $\mu$  wide (216-308  $\mu$ ); the head dorsally with 3-6 anterior hairs, and two rows of four hairs between the eyes, about 70  $\mu$  long. Antennae with four segments, 177  $\mu$  long, segment III almost smooth, 49  $\mu$  long, IV with spinulose imbrications, 71  $\mu$  long; length of hair on segment II, 30  $\mu$ , on III, 45  $\mu$ . Frons with two horns, pointed, smooth, 85  $\mu$  long (60-145  $\mu$ ) and 35  $\mu$  wide at the base, with hairs 5-6  $\mu$  long, but at the base one hair sometimes up to 60  $\mu$  long. Tibia of the fore leg 190  $\mu$  long, length of distal hairs of tibiae about 50  $\mu$  long. All first tarsal segments with two hairs, about 60  $\mu$  long. Two apical hairs of the second tarsal segment of the hind leg with expanded tips, 70  $\mu$  long, the other apical hairs smaller and acute. Marginal wax glands on all segments of the body, or only on the posterior abdominal segments. Abdominal segments dorsal to the marginal wax glands with one hair, tergites I-V usually with four hairs, VI with 2-4, VII and VIII with two, about 45  $\mu$  long. Cauda with two hairs, 25-35  $\mu$  long. Siphunculi present, diameter of the pore about 25  $\mu$ .

The embryos inside alatae of collection no. 986 are similar to first stage larvae of apterae, with horns and siphunculi.

Host plant records.— Specimens were collected in Java on the plants, in the places, and on the dates indicated, while the collectors are indicated by numbers between parentheses: P. van der Goot or Van der Goot (1917) (1), in the collection at the Laboratorium voor Entomologie, Wageningen; F.W. Rappard (2), in the collection at the British Museum (Natural History), London; and D. Noordam (3), in the collection at the Rijksmuseum van Natuurlijke Historie, Leiden. *Panicum* spec., Kartapoera, 2.ix.1913 (1), *Panicum* spec., Songoriti (980 m), 24.vi.1914 (1); *Setaria palmifolia* (Willd.) Stapf, Gondang (700 m), 13.viii.1950 (2); *Paspalum*, Tjobanrondo (1350 m), 28.xi.1951 (2); *Setaria palmifolia*, Sindanglaya (1100 m), 29.v.1976 (3); *Microstegium ciliatum* (Trin.) A. Camus, Sindanglaya (1100 m), 23.vii.1977 (3).

The aphids live on the lower side of leaves, small populations in isolated groups, large populations covering the whole surface.

Alatae were collected 24.vi.1914, 13.viii.1950, and 23.vii.1977.

Etymology.— Panici, from *Panicum*; the name refers to *Panicum*, the first host on which Van der Goot (1917) found this aphid.

**Genus *Distylaphis* gen. nov.**  
(figs. 285-309)

*Schizoneuraphis foliorum* Van der Goot, 1917: 250 (type species *Schizoneuraphis foliorum* Van der Goot, 1917).

This genus includes only one species which Van der Goot (unpublished) transferred to a genus named *Distylaphis*. The present publication describes this particular species that lives on leaves of *Distylium stellare*, and also includes morphs from galls occurring on the same plant species; an exceptional host alternation.

Description.— I. Morphs from leaves of *Distylium stellare* O.K.

Apterous viviparous female.— (one species). In life: Greenish, the margins of the body thickly powdered with wax, the dorsum with transverse wax patches. Macerated specimens (third stage larva). Body colourless, 1.05-1.23 mm long, 1.6-1.8 times as long as it is wide. The head smooth, anteriorly with two pairs of hairs, and between the eyes a transverse row of six hairs, 45-57  $\mu$  long. Antennae with four segments, 174-200  $\mu$  long, 0.15-0.18 times as long as the body, and 0.65-0.77 times the distance between the outer margins of the eyes; segment III, 0.5 times as long as IV (in adults 0.7 times); the last antennal segment 4.0-4.3 times as long as its processus terminalis. The eyes with three ommatidia. Ultimate rostral segment without accessory hairs, 67-71  $\mu$  long, 0.76-0.82 times as long as the second tarsal segment of the hind leg; stylets 420-460  $\mu$  long. Wax glands circular with a diameter of 1.5-2.5  $\mu$ , at a distance from each other of 1-5  $\mu$ , arranged in marginal areas which are interrupted in the middle and by the eyes. Meso- and metathorax each marginally with two hairs and dorsally each with 10-14 hairs. Legs very pale brown; tibia of the fore leg 196-215  $\mu$  long, 0.74-0.82 times as long as the distance between the outer margins of the eyes. Chaetotaxy of first tarsal segments 3, 3, 2. Second tarsal segments of the hind leg with two dorsoapical acute hairs. Empodial hairs of the hind leg 6-8  $\mu$  long. Circular wax glands marginally on each of the thoracic segments, and a pair of pleural patches on each segment. Abdomen colourless with circular wax glands marginally and pleurally as on the thorax, on segments I-VII one pair of patches, and on VIII one patch. One marginal hair on each side to what corresponds to segments I-VII, the hair on segment VI close to the siphunculus; tergite I with 5-7 hairs, II with 3-4, III, 3-4; IV two, 29-43  $\mu$  long; V-VIII with two, of VIII, 59-67  $\mu$  long. Siphunculi located dorsally on segment VI, the pore with a diameter of 23-25  $\mu$ . Cauda with two hairs, 23-25  $\mu$  long. Subanal plate with 10-12 hairs. Spiracles on the abdomen on segments II-V.

Apterous oviparous female.— In life dull olive-green. Body 1.98 mm long, 1.00 mm wide, the dorsum with transverse rows of long bristles. Antennae 310  $\mu$  long, with four segments; segment III, 1.2 times as long as IV. Cauda wart-like, well constricted at the base. Wax glands lacking on head and thorax, but circular wax glands present on abdominal segments, on segments I-IV two marginal groups and two spinal groups; on segments V-VII marginal and spinal groups are fused together; on tergite VIII only one small group. Eggs on the underside of leaves were 360  $\mu$  long and 230  $\mu$  wide.

First stage larva of apterous viviparous female 500-650  $\mu$  long. Antennae with four segments, segment IV with a hair 80-92  $\mu$  long.

Stylets 520-545  $\mu$  long. The legs, especially the fore leg with some long hairs, 55-



129  $\mu$  long. Siphunculi present, on abdominal segment VI. The body with areas of circular wax glands with a diameter of 1.5-2.5  $\mu$ , at a distance from each other of 1-5  $\mu$ , on the head, and marginally and pleurally on thorax and abdomen.

II. Morphs from gall no. 3 of *Distylium stellare* O.K.

Apterous viviparous female.— Body almost colourless, 1.30 mm long, 1.3 times as long as it is wide. The head anteriorly in the middle with five hairs, posteriorly with 10, 80-130  $\mu$  long. Antennae with three segments, 169  $\mu$  long. Eyes with three ommatidia. Ultimate rostral segment 73  $\mu$  long, 1.38 times as long as the second tarsal segment of the hind leg; stylets 236  $\mu$  long. Wax glands lacking on head and thorax. The thoracic segments with some long hairs, 150-196  $\mu$  long, and several hairs 60-100  $\mu$  long. All first tarsal segments with two hairs. Abdomen without segmental borders, number of dorsal hairs on segments I and II about 15, on V-VI two, on VII four, on VIII six; length of two hairs on tergite I, 178  $\mu$ , on the other tergites 47-92  $\mu$ . Wax glands occur marginally on each side in three areas: on about segment I, segments II-III, and IV-VI; the glands are a mixture of s-shaped glands with some circular glands with a diameter of 2-3  $\mu$ .

Alate viviparous female.— (migrant). Body length 2.61-3.33 mm. Hairs on the head 10-17  $\mu$  long. Antennae 750-875  $\mu$  long, segments III-V with annular rhinaria, III with 20-26, IV with 8-12, V with 7-10; the primary rhinaria are moulded on segment IV with 6-8 annular rhinaria to a complex structure, on V with 4-6. The last rostral segment 78-81  $\mu$  long, 0.56-0.60 times as long as the second tarsal segment of the hind leg, without accessory hairs; length of the stylets 310-330  $\mu$ . The basal area of the fore wing and the anal vein pale brown. Length of the fore tibia 890-1045  $\mu$ , of the second tarsal segment of the hind leg 129-141  $\mu$ . Tergite IV with 10 hairs, 16-33  $\mu$  long, VIII with 10-11 hairs, 30-63  $\mu$  long. Siphunculi on segment VI. Cauda posteriorly in the middle with a process, the cauda without a constriction, with 8-11 hairs, the longest 47-55  $\mu$ , the shortest 16-17  $\mu$ . Subanal plate with 17-19 hairs. The subgenital plate with 16-23 hairs on the plate, and 18-25 along the posterior margin. Gonapophyses two, the longest hairs 34-40  $\mu$ .

First stage larvae developing to apterae are unknown from the galls, but last stage larvae developing into alatae have wax glands as lines without interruption constituting ovals, or sometimes s-shaped or circular wax glands. Soldier-type first stage larvae occur in a collection with alatae. The body 670-765  $\mu$  long, the fore legs more sclerotic and sturdy than the other legs, the first tarsal segment fused with the second, the claws of unequal size.

Embryos inside the body of the alatae are exactly like first stage larvae of apterae living on leaves of *D. stellare*.

Etymology.— *Distylaphis*, aphid from *Distylium* the name of the genus of the plant on which the aphid *Schizoneuraphis foliorum* was found by Van der Goot (1917). In his unpublished manuscript Van der Goot intended to transfer *S. foliorum* to the new genus *Distylaphis*.

***Distylaphis foliorum* (Van der Goot, 1917) comb. nov.**  
(figs. 285-309)

*Schizoneuraphis foliorum* Van der Goot, 1917: 250.

Types.— Neotype (here designated, last stage larva of apterous viviparous female, freely living on leaf of *Distylium stellare* O.K., Dieng (2050 m) - Java, leg. D. Noordam, no. 708-3-1. Last stage and other larval stages of apterous viviparous females, with the same data as the neotype on slides 708-1 to 708-4. Neotype in the collection at the Rijksmuseum van Natuurlijke Historie, Leiden.

Van der Goot (unpublished) remarks that the description (Van der Goot, 1917) of the apterous viviparous female was drawn from specimens which afterwards proved to be not quite adult, and in his manuscript he mentions a few characters of the adults which are mentioned below; this material is lost. Below follows also the description of apterous oviparous females which Van der Goot reports in his manuscript. Embryos inside alatae collected by Harjono 24.i.1958 from a gall of *Distylium stellare* indicated by no. 3 do not differ from first stage larvae of the morph which freely live on leaves of *D. stellare*, and are, therefore considered in this publication to belong to the same species, *D. foliorum*.

I. Morphs from leaves of *Distylium stellare*.

1. Apterous viviparous female.— In life (pl. 30): Bright greenish. The margins thickly powdered with wax, in old specimens thread-like; the dorsum with two longitudinal rows of transverse wax patches, in old specimens thickly powdered all over.

Larvae green with flocky wax especially at the margins.

Morphological characters. Length of the body some 1.44 mm. Antennae 250  $\mu$  long, with four segments, segments I and II equal in length, segment III, 1.3 times as long as II; IV, 1.9 times as long as II. Cauda distinctly wart-like, the subanal plate bilobed. Wax glands as described by Van der Goot (1917).

2. Apterous oviparous female.— In life: Body dull olive-green, with a brownish tinge due to the eggs inside the body. Eyes black. Antennae and legs brownish. Siphunculi and cauda darkish.

Morphological characters. Body elongate ovate, slightly arched, 1.98 mm long, 1.00 mm wide, the dorsum with irregular transverse rows of long bristles. Eyes with three ommatidia. Antennae 310  $\mu$  long, with four segments; the relative length of the segments about 11, 12, 27, 23; segment III usually slightly broader at the tip, and IV with imbrications. The rostrum reaches to the second pair of coxae. Legs moderately long, with a few short hairs. Siphunculi reduced to pores. Cauda wart-like, well constricted at the base. Anal plate distinctly bilobed, with some long hairs. Rudimentary gonapophyses two, separate, with some rather strong hairs. Abdominal spiracula on segments I-V, those on segment I rudimentary. Wax glands lacking on the head and thorax, but on the abdomen distinct and numerous; the facets are minute, circular or sub-ovate, always distinctly separate, the groups without a common chitinous ring and without a plate-hair; on segments I-IV are two marginal and two spinal groups, the marginal roundish and of equal size, the spinal groups on segments I and II are oval and separate, on segments III and IV sub-ovate and nearly touching each other. On segments V-VII marginal and spinal groups are fused, occupying nearly the whole dorsal surface; on segment VIII only a small dorsal group, oval and with a small number of facets.

On April 20th 1916 along the road Kedjadjar-Dieng (1500-2000 m), besides numerous adult viviparous females a fairly large number of oviparous females were present on other leaves. This is the first time that sexual forms were observed in Java.

No males were seen; on the lower side of some leaves a few pale brown oval eggs of the aphid were found, 0.36 mm long and 0.23 mm wide. One of the oviparous females still contained some 23 mature eggs in her body. Towards the end of August 1916 oviparous females were only found on some trees; the viviparous females were then more numerous (Van der Goot, unpublished).

3. First stage larva (figs. 285, 286) of apterous viviparous female (described from five specimens). Body almost colourless, 500-650  $\mu$  long, distance between the outer margins of the eyes 157-174  $\mu$ . Anterior to the eyes two pairs of hairs, 69-76  $\mu$  long, and two  $\mu$  wide close to the base, between the eyes a row of six hairs, 59-71  $\mu$  long. Antennae with four segments, 126-136  $\mu$  long, hair of segment II, 71-91  $\mu$  long; segment III, 40-49  $\mu$  long, 0.89-1.04 times as long as IV, with some smooth imbrications, and with a rhinarium, 47-53  $\mu$  from the tip of segment IV, and without hairs; IV with smooth imbrications, 45-50  $\mu$  long, the processus terminalis 16-18  $\mu$ , and with a hair 80-92  $\mu$  long, the four apical setae 20-23  $\mu$  long. Stylets 520-545  $\mu$  long. The pronotum with two anterior and two posterior hairs, 51-57  $\mu$  long; mesonotum with 9-13 hairs, the metanotum with 9-13 hairs. Coxa, trochanter, femur and tibia, especially of the fore leg with some long hairs, 55-129  $\mu$  long. Length of the fore tibia 102-112  $\mu$  long. The hind tibia distally with two setae, the longest 8-10  $\mu$ . All first tarsal segments with two hairs, of the hind leg 27-28  $\mu$  long. The two dorsoapical hairs of the second tarsal segment of the hind leg acute, 65-72  $\mu$  long. The empodial hair of the hind leg 3-4  $\mu$  long. Abdominal tergite I and II with 2-4 hairs, the other tergites with two, on IV, 22-30  $\mu$  long, on VIII, 57-72  $\mu$ . Siphunculi on segment VI, the pore with a diameter of 20-22  $\mu$ . Cauda with two hairs, 14-20  $\mu$  long. The body with areas of circular wax glands with diameters of 1.5-2.5  $\mu$ , at a distance from each other of 1-5  $\mu$ ; the areas are arranged in oval or somewhat irregular patches with diameters of 25-100  $\mu$ , the border of the patches are the wax glands, a chitinous boundary is lacking. The patches are present marginally on all segments of the body, on the head interrupted anteriorly in the middle, and by the eyes, and in the other segments by the segmental borders. On each of the segments, prothorax to abdominal segment VII, a pair of patches is present pleurally, and on tergite VIII one patch is present.

4. Third stage larva of apterous viviparous female. In life: Green with flocky wax, especially along the margin of the body.

Macerated specimens.— (figs. 287, 288; described from five specimens): Body length 1.05-1.23 mm.

Head.— Head colourless, dorsally smooth, distance between the outer margins of the eyes 247-300  $\mu$ , anteriorly with two pairs of hairs, 55-64  $\mu$  long, and between the eyes a transverse row of six hairs, 45-57  $\mu$  long. Antennae very pale brown, with four segments, 174-200  $\mu$  long, 0.15-0.18 times as long as the body, 0.65-0.77 times the distance between the outer margins of the eyes; segments I-III almost smooth, IV with some smooth imbrications; segment III, 45-53  $\mu$  long, 0.53-0.64 times as long as IV; segment IV, 73-86  $\mu$  long, the processus terminalis 18-20  $\mu$  long, with one hair 15-19  $\mu$  long, and four apical setae, 14-15  $\mu$  long. (The distal part of segment III with a rhinarium of the first stage larvae is fused in next stages with segment IV). Eyes pale brown, with three ommatidia with a diameter of 12  $\mu$ . Ultimate rostral segment 67-71  $\mu$  long, 0.76-0.82 times as long as the second tarsal segment of the hind leg; stylets 420-460  $\mu$  long. Wax glands as in first stage larvae.

Thorax.— Prothorax with on each side two marginal hairs and dorsally 4-6 hairs.

The meso- and metanotum each with 10-14 hairs. Legs very pale brown, smooth, longest hairs on coxa, trochanter, femur and tibia 15-41  $\mu$ . Tibia of the fore leg 196-215  $\mu$  long, 0.74-0.82 times as long as the distance between the outer margin of the eyes; tibia of the hind leg distally with two setae, the longest 12-14  $\mu$ ; first tarsal segments of the fore leg with three hairs, the lateral 0.9-1.0 times as long as the middle hair; of the midleg with three hairs, of the hind leg with two, 16-23  $\mu$  long; second tarsal segments of the hind leg 0.30-0.36 times as long as the tibia of the hind leg, and 0.30-0.36 times the distance between the outer margins of the eyes, with two dorsoapical acute hairs, 40-45  $\mu$  long. Empodial hairs of the hind leg 6-8  $\mu$  long. Length of the segments of the hind leg: femur plus trochanter 269-281  $\mu$ , tibia 279-291  $\mu$ , 1.00-1.08 times as long as the femur, and 0.97-1.16 times the distance between the outer margins of the eyes, first tarsal segment 37-40  $\mu$  long, second tarsal segment 83-89  $\mu$ . Arrangement of the wax glands as in first stage larvae.

Abdomen.— Abdomen colourless, with wax glands as in the first stage larva. Tergite I with 5-7 hairs, II with 3-4; III, 2-3; IV two, and 29-43  $\mu$  long, V-VIII with two, of VIII, 59-67  $\mu$  long; ventral hairs on segment IV, 21-27  $\mu$  long. Siphunculi colourless, located dorsally on segment VI, the pore with a diameter of 23-25  $\mu$ , without a rim. Cauda with two hairs, 23-25  $\mu$  long. Subanal plate with 10-12 hairs.

II. Morphs from gall no. 3 of *Distylium stellare* O.K.

1. Apterous viviparous female

Macerated specimen.— (figs. 289-291; described from one specimen). Body length 1.30 mm, oval, 1.3 times as long as it is wide.

Head.— Head anteriorly in the middle very pale brown, smooth, distance between the outer margins of the eyes 350  $\mu$ ; anteriorly in the middle with five hairs, posteriorly with 10 hairs, more or less in two transverse rows, the hairs 80-130  $\mu$  long. Antennae pale brown, with three segments, 169  $\mu$  long, 0.13 times as long as the body, and 0.48 times the distance between the outer margins of the eyes; segments I and II almost smooth; III with a few indistinct spinulose imbrications, tapering to the end, without hairs, with three apical setae, the processus terminalis 12  $\mu$  long, the penultimate rhinarium 41  $\mu$  from the tip. Eyes brown, with three ommatidia with a diameter of 11  $\mu$ . Ultimate rostral segment 73  $\mu$  long, 1.38 times as long as the second tarsal segment of the hind leg; stylets 236  $\mu$  long. Wax glands are lacking.

Thorax.— The pronotum colourless, fused with the head, on each side two marginal hairs, and three hairs in the medial area along the posterior margin, the longest 157  $\mu$ . Meso- and metathorax each with 2-3 marginal hairs, and about 10 dorsal hairs, long and shorter, the longest 150-196  $\mu$ . Legs evenly brown, only the tibiae with a few spinulae. Tibia of the fore leg 155  $\mu$  long, 0.44 times as long as the distance between the outer margins of the eyes. All first tarsal segments with two hairs, of the hind leg 27  $\mu$  long. Second tarsal segments of the hind leg 0.25 times as long as the tibia of the hind leg, and 0.15 times the distance between the outer margins of the eyes, with two dorsoapical hairs, 35-40  $\mu$  long, with expanded tips, two  $\mu$  wide. Empodial hairs are lacking. Length of the segments of the hind leg: femur plus trochanter 220  $\mu$ , tibia 208  $\mu$ , 0.94 times as long as the femur, and 0.63 times the distance between the outer margins of the eyes, first tarsal segment 33  $\mu$  long, second tarsal segment 53  $\mu$  long. Wax glands are lacking.

Abdomen.— Abdomen colourless, segmental borders not observable, spinulose imbrications on segment VIII. Areas with wax glands (figs. 280, 281) occur margin-

ally on each side in three areas: about segment I, segments II-III and segments IV-VI; the glands are a mixture of s-shaped glands and some circular glands with a diameter of 2-3  $\mu$ . One marginal hair on each side to what corresponds to segments I-VII, 90-150  $\mu$  long; number of hairs on tergites (with some reserve for confusion with embryo hairs): I, 14; II, 16; III six; IV three; V two; VI two; VII four and VIII six; length of two hairs on tergite I, 178  $\mu$ ; all other hairs on the tergites 47-92  $\mu$  long; ventral hairs 15-80  $\mu$  long. Siphunculi lacking. Cauda transversely elongate about 100  $\mu$  wide, ventrally in the middle with a small process, with six hairs, the longest 78  $\mu$ . Subanal plate bilobed, slightly incised in the middle, with 10 hairs, 82  $\mu$  long. Subgenital plate with conspicuous spinulose imbrications, with eight anterior hairs, 80  $\mu$  long, and eight hairs along the posterior margin, 63  $\mu$  long. Gonapophyses two, each with five hairs, the longest 14  $\mu$ .

## 2. Alate viviparous female (migrant)

Macerated specimens.— (figs. 292-298; described from nine specimens). Body length 2.61-3.33 mm, 2.0-2.5 times as long as it is wide.

Head.— (fig. 282). Head black, smooth, width across the eyes 520-620  $\mu$ , anterior to the paired ocelli in the middle three pairs of hairs, 23-31  $\mu$  long, posterior 6-7 hairs, 10-17  $\mu$  long, 0.02-0.03 times as long as the width of the head across the eyes; ventrally, posterior to the base of the antennae on each side 8-12 hairs. Antennae (fig. 293) brown, with black rings, with five segments, 750-875  $\mu$  long, 0.24-0.32 times as long as the body, and 1.3-1.5 times the width of the head across the eyes; segment I with longitudinal wrinkles, segment II with longitudinal wrinkles and distally reticulated, almost without spinulae; segments III-V with ring-shaped secondary rhinaria, the rings are not closed on the dorsal side, with a space of 2-35  $\mu$ ; between the rhinaria are 3-6 concentric spinulose imbrications shaping somewhat of a network, the imbrications dorsally and ventrally with interconnections; the rhinaria 2-4  $\mu$  wide. The primary rhinaria are moulded on segment IV with 6-8 annular rhinaria to a complex structure, on segment V with 4-6; segment III with 20-26 annular rhinaria, IV with 8-12, V with 7-10; hairs on segments III-V lacking, but on segment V four or rarely five apical setae, 12-16  $\mu$  long. Length of segment III, 350-405  $\mu$ , 1.9-2.6 times as long as IV, 2.2-2.6 times as long as V, and 1.0-1.2 times as long as IV plus V; segment IV, 155-193  $\mu$  long, 1.0-1.2 times as long as V; segment V, 135-170  $\mu$  long, the processus terminalis 10-20  $\mu$ . The last rostral segment 78-81  $\mu$  long, 0.56-0.60 times as long as the second tarsal segment of the hind leg, without accessory hairs; length of the stylets 310-330  $\mu$ . Eyes black, the ocular tubercle extending 25  $\mu$ .

Thorax.— Sides of the prothorax brown, mesothorax black. Fore wing (figs. 294-295), the leading edge and the pterostigma brown, the basal area and the borders of the anal vein pale brown; the medial vein once branched, median I, 1.4-1.7 times as long as the distance from the base of the fork to the base of the anal vein; the bifurcation of the anal vein and cubitus 90-177  $\mu$  from the subcosta; the hind wing with two oblique veins. Legs brown, the basal part of the femora paler; tibiae and second tarsal segments with spinulose imbrications, the spinulae 1-2  $\mu$  long; the tibia of the fore leg 890-1045  $\mu$  long, 1.6-1.9 times as long as the width of the head across the eyes, length of the hairs of the hind tibia 33-37  $\mu$ ; all first tarsal segments with three hairs, the lateral hairs of the fore tarsus 2.7-3.0 times as long as the middle; length of hairs of the first tarsal segments of the hind leg 63-65  $\mu$ ; the four apical hairs of the second tarsal segment of the hind leg (fig. 296) with expanded tips, the dorsal hairs 65-

72  $\mu$  long, the tips four  $\mu$  wide; empodial hair of the hind leg with a slightly expanded tip, 35-37  $\mu$  long. Length of the hind segments: femur fused with trochanter 677-780  $\mu$ , tibia 950-1085  $\mu$ , 1.34-1.52 times as long as the femur, and 1.74-1.95 the width of the head across the eyes; first tarsal segment 43-50  $\mu$  long, second tarsal segment 129-141  $\mu$ .

Abdomen.— (fig. 297). Abdomen colourless, tergites VII and VIII only with rather indistinct spinulose imbrications. Segments I-VII each with a marginal hair, 49-63  $\mu$  long; in one specimen tergite I with 12 hairs; II, 11; III, 13; IV, 10, 16-33  $\mu$  long; V, 10; VI eight; VII, 10. Tergite VIII with 10-11 hairs, 30-63  $\mu$  long. Siphunculi situated on segment VI, a pale brown ring about 30  $\mu$  high with some blunt spinulae, the pore with a diameter of 40-50  $\mu$ . Cauda (fig. 298) depressed obovate, e.g. 196  $\mu$  wide, 108  $\mu$  long, with posteriorly in the middle a process, 20  $\mu$  long, and about 18  $\mu$  wide at the point where it widens to the cauda itself; the cauda without a constriction, with 8-11 hairs, the longest 47-55  $\mu$ , the shortest 16-17  $\mu$ . Subanal plate bilobed, with 17-19 hairs, 59-72  $\mu$  long. Subgenital plate with 16-23 hairs, anteriorly on the plate, 49-59  $\mu$  long, and 18-25 hairs along the posterior margin, 55-61  $\mu$  long. Gonapophyses two, each with 8-9 hairs, the longest 34-40  $\mu$ . Spiracles four, on segments II-V. Wax glands are lacking.

Larvae developing to apterae are lacking, but a soldier-type of first stage larvae occurs in the material with alatae (Hille Ris Lambers refers to this in his publication 1966: 56), and the single aptera in the collection contains in the body embryos of soldiers only.

The embryos inside the alatae are different from morphs of *D. stellare* galls, but no differences could be found between the characters of these embryos and larvae living freely on leaves of *D. stellare*. Below, the soldiers, larvae of alatae and embryos inside the body of alatae are described.

3. First stage larva (figs. 299-302), soldier type (description of five specimens). Body length 670-765  $\mu$ , 1.8-2.6 times as long as it is wide, length of the head plus pronotum 218-248  $\mu$ , 0.76-0.83 times the width of the prothorax. The head pale brown, width of the head across the eyes 212-220  $\mu$ , without horns, anterior in the middle three pairs of hairs, usually two of these located ventrally, 74-92  $\mu$  long; between the eyes six hairs, 76-118  $\mu$  long. Antennae with four segments, 149-163  $\mu$  long, 0.21-0.23 times as long as the body, and 0.70-0.77 times the width of the head across the eyes; length of a hair on segment I, 49-78  $\mu$ ; on II, 27-100  $\mu$ ; segment III, 55-65  $\mu$  long, 1.0-1.2 times as long as IV, with some imbrications with indistinct spinulae, with a rhinarium, and without hairs; segment IV, 53-59  $\mu$  long, the processus terminalis 17-19  $\mu$  long, with a hair 72-125  $\mu$  long, with four apical setae, 22-24  $\mu$  long. The last rostral segment (fig. 301) 61-67  $\mu$  long, 0.68-0.74 times as long as the second tarsal segment of the hind leg; stylets 240-262  $\mu$  long. The prothorax the same colour as the head, the meso- and metathorax paler, with thread-like marginal hairs, 73-130  $\mu$  long, and dorsally on each segment about two long hairs, 48-86  $\mu$  long, and some shorter hairs. Legs pale brown, the fore legs darker; fore legs more sclerotic and sturdy than the other legs, femur 224-248  $\mu$  long and 106-120  $\mu$  wide in the middle, 2.1-2.2 times as long as it is wide, with thread-like hairs, 90-150  $\mu$  long; tibia 204-236  $\mu$  long, and 72-83  $\mu$  wide in the middle, 2.5-2.8 times as long as it is wide, distally on the dorsal side with an articulation with the tarsus, ventrally with a membrane and connected with the tarsus by a tendon; first tarsal segment fused with the second, 68-71  $\mu$  long and 52-58  $\mu$  wide at the base; the claws of unequal size, one 64-69  $\mu$  long

and 27-30  $\mu$  wide at the base, the other 51-55  $\mu$  long, and 16-19  $\mu$  wide at the base. Femur of the hind leg 204-232  $\mu$  long, and 53-56  $\mu$  wide in the middle; the tibia 212-240  $\mu$  long, and 36-41  $\mu$  wide in the middle, with hairs 74-92  $\mu$  long. All first tarsal segments with two hairs, of the hind leg 29-31  $\mu$  long; the second tarsal segment of the hind leg 88-93  $\mu$  long, with two acute dorsoapical hairs, 82-88  $\mu$  long. Abdominal segments I-VII marginally each with one hair, 72-130  $\mu$  long, rarely 33-69  $\mu$ , and dorsally with about four hairs, 20-60  $\mu$  long; tergite VIII with two hairs, 71-114  $\mu$  long. Siphunculi cylindrical, 25-31  $\mu$  long, the pore 28-35  $\mu$  wide. Cauda with a small process in the middle, with two hairs, 21-29  $\mu$  long. Wax glands marginally on segments I-VI, rather indistinct, a mixture of circular and s-shaped glands.

4. Last stage larva of alata (figs. 303-305). Description of one specimen. Body length 2.24 mm, 1.9 times as long as it is wide. Length of hairs anteriorly on the head 40-63  $\mu$ , of hairs between the eyes 40-82  $\mu$ . Antennae with five segments, III and IV without hairs, V with one hair, 22  $\mu$  long. Thorax and abdomen with hairs with a thread-like end, marginally 50-92  $\mu$  long, dorsally 50-65  $\mu$ ; tergite VII with eight hairs, VIII with nine. Siphunculi pore with a diameter of 33  $\mu$ . Cauda with a process posteriorly in the middle, with nine hairs, the longest 47  $\mu$ . Wax glands marginally, observed dorsally and ventrally on segments II-VII; the glands are lines without interruption constituting ovals with a diameter of 15-30  $\mu$ , the lines with inward and outward bends as in a jigsaw puzzle; the lines run over some distance parallel to each other so that all lines together constitute a network; rarely, in some areas, the lines are interrupted and constitute semicircular arches, s-shaped lines and rings as in the apterous viviparous female.

5. Embryo inside alate viviparous female (migrant) (figs. 306-309) from gall no. 3 (measurements presented for one specimen). Body colourless, 590  $\mu$  long. Anterior to the eyes two pairs of hairs, 61  $\mu$  long, and two  $\mu$  wide close to the base; between the eyes a row of six hairs, 62  $\mu$  long. Antennae with four segments, 118  $\mu$  long, hair of segment II, 90  $\mu$  long; segment III, 41  $\mu$  long with some smooth imbrications and with a rhinarium 36  $\mu$  from the tip of segment IV, and without hairs; IV with smooth imbrications, 31  $\mu$  long, the processus terminalis 15  $\mu$ , and with a hair 83  $\mu$  long, the four apical setae 23  $\mu$  long. Stylets 540  $\mu$  long. The pronotum with two anterior and two posterior hairs, 55  $\mu$  long; mesonotum and metanotum each with 10 hairs, 43  $\mu$  long. Coxa, trochanter, femur and tibia of the fore leg with some long hairs, 68-88  $\mu$  long. The hind tibia with two setae, the longest 9  $\mu$ . All first tarsal segments with two hairs. The two dorsoapical hairs of the second tarsal segment of the hind leg blunt, 65  $\mu$  long. Abdominal tergite I with six hairs, II with three; III with two; IV with two, 33  $\mu$  long; V-VII with two; VIII with two, 67  $\mu$  long. Siphunculi on segment VI, the pore with a diameter of 20  $\mu$ . Cauda with two hairs, 20  $\mu$  long. The body with areas of circular wax glands (fig. 306) with diameters of 1.5-2.5  $\mu$ , at a distance from each other of 1-5  $\mu$ ; the areas are arranged in oval patches without a chitinous boundary. The patches are present marginally on all segments of the body, on the head anteriorly interrupted in the middle and also by the eyes, and in the other segments by the segmental borders. On each of the segments, prothorax to abdominal segment VII, a pair of patches is present pleurally, and on tergite VIII one patch is present.

Host plant records.— Specimens were collected in Java from *Distylium stellare* O.K., by P. van der Goot (1), the material is lost; by Harjono (2) in the collection at the British Museum (Natural History), London; and by D. Noordam (3) in the collection

at the Rijksmuseum van Natuurlijke Historie, Leiden. I. from leaves: Kedjadjar, Mt. Dieng (1500 m), viii.1915, larvae of apterae; Kedjadjar, Mt. Dieng (1500 m), 20.iv.1916 apterous viviparous females and apterous oviparous females; Kedjadjar (1500 m) and Patek-Banteng (2575 m), 30.viii.1916 apterous viviparous females more numerous than apterous oviparous females (1); Dieng (2050 m), 22.vii.1976 (3), apterous viviparous females, larvae.

II. from gall no. 3: Dieng, x 1957 (2), apterous viviparous female and larvae of alatae; Dieng 24.i.1958 (2), many alate viviparous females.

The aphids live on leaves of *Distylium stellare*, the apterae live on the lower side of young or old leaves, along the main vein, and the large lateral veins. The apterous oviparous females also live on the lower side of leaves. From galls only one apterous viviparous female producing soldier type larvae was collected x.1957, all other specimens were larvae of alatae, and 24.i.1958 only numerous alatae.

Etymology.— Foliorum, of leaves, name applied to this species by Van der Goot (1917).

#### Genus *Euthoracaphis* Takahashi, 1938 (fig. 310)

*Euthoracaphis* Takahashi, 1938: 14; 1959: 8 (type species *Thoracaphis umbellulariae* Essig, 1932).  
*Euthoracaphis*; A.K. Ghosh & Raychaudhuri, 1973: 156.

##### Description (one species).

Apterous viviparous female.— In life: Black, the dorsal side completely covered with a thin floury secretion.

Macerated specimens.— Body a dark brown box with a flat oval dorsum and a flat ventral side; the dorsum consists of: (1) the prosoma, the fused head, thorax and abdominal segment I, divided into a large trapeziform medial area, one anterior and two lateral parts; (2) a complex consisting of the fused abdominal tergites II-VII; (3) the free tergite VIII. Ratio of the lengths of the prosoma, the complex II-VII, and segment VIII are about 100:30:15. Length of the body 785-900  $\mu$ , 1.4 times as long as it is wide, all parts of the prosoma with pustules, 10-20  $\mu$  diameter. In the middle area from the frons to the posterior part of the prosoma six pairs of sturdy hairs, 80-125  $\mu$  long, next to these in *E. heterotricha* numerous smaller hairs, 25-70  $\mu$  long. Antennae with three segments, 125-145  $\mu$  long, segment III, 4-5 times as long as segment II, with one rhinarium 35  $\mu$ , and another 4-8  $\mu$  from the tip. Eyes with three ommatidia. First tarsal segments with 3, 3 and 2-3 hairs (Ghosh & Raychaudhuri, 1973). The complex of abdominal segments II-VII, almost smooth, with six hairs on each side; anterior to the siphunculi on each side about 10 hairs and posterior to the siphunculi 1-2, next to two posteromedial hairs on segment II in *E. heterotricha*, but presumably lacking in the other species. Siphunculi a thick ring about 20  $\mu$  wide. Abdominal segment VIII with four hairs in *E. heterotricha*, and with two in the other species. Cauda transversely elongate, not quite constricted at the base. Subanal plate bilobed. Gonapophyses two.

Etymology.— *Euthoracaphis*, truly *Thoracaphis*, name given by Takahashi (1938).



***Euthoracaphis heterotricha* A.K. Ghosh & Raychaudhuri, 1973  
(fig. 310)**

*Euthoracaphis heterotricha* A.K. Ghosh & Raychaudhuri 1973: 156.

This species was collected by Van der Goot in 1916 and described in his manuscript; many data are borrowed from this in the next description. A few fragments of apterae of Van der Goots collections are preserved and are in the collection at the Laboratorium voor Entomologie at Wageningen; they enabled this species to be identified with certainty.

Apterous viviparous female.— (fig. 310). In life: Body bluish black. Eyes, legs, etc. black or bluish. The dorsal side completely covered with a thin floury secretion.

Macerated specimens described from fragments of three specimens, and the manuscript of Van der Goot. Body a box with a flat oval dorsum e.g. 785  $\mu$  long and 540  $\mu$  wide, and a flat almost circular ventral side e.g. 665  $\mu$  long and 575  $\mu$  wide, and margins which are almost perpendicular at the front, globular at the sides, and the back bending forwards from top to bottom. The dorsum, the sides and the outer margin of the venter is a rigid structure, brown, sclerotic, the flat venter is colourless; the dorsum consists of: (1) the prosoma, the fused head, thorax and abdominal segment I, divided by sutures into a large trapeziform medial area, an anterior and two lateral parts: (2) a complex consisting of the fused abdominal tergites II-VII; (3) the free tergite VIII. Ratio of the lengths of the prosoma, the complex II-VII, and segment VIII are 100 : 29 : 15. All parts of the prosoma with round to oblong oval pustules, 10-20  $\mu$  diameter, raised not more than five  $\mu$ , also located around areas of muscle plates; between the eyes four sturdy hairs and anterior to these another four sturdy hairs; posterior to these frontal hairs to the end of the prosoma are situated in the middle area, two longitudinal rows of four sturdy hairs, 80-125  $\mu$  long, on tubercles with diameters of 12-14  $\mu$ ; on the lateral parts also some such sturdy hairs; on all parts numerous smaller hairs 25-70  $\mu$  long. Antennae inserted about 200  $\mu$  below the dorsum, with three segments, 125  $\mu$  long, segment I brown, II and III pale brown, III 90-98  $\mu$  long, four to five times as long as segments I and II, with one rhinarium 35  $\mu$  from the tip, and the other 4-8  $\mu$ . Eyes with three ommatidia, located at the sides, the distance between the outer margins about 300  $\mu$ . Legs inserted at the sides, about 200  $\mu$  below the dorsum. One spiracle between and dorsal to fore- and midleg, the other between and dorsal to the mid- and hind leg. Abdominal segments II-VII a plate separated from the prosoma and segment VIII, with a straight anterior border and an emarginate posterior margin, almost smooth, with six pairs of marginal hairs 10-30  $\mu$  long, 3-4  $\mu$  wide at the base on tubercles with a diameter of 10-14  $\mu$ ; anterior to the siphunculi on each side about 10 hairs, somewhat less sturdy, and posterior to the siphunculi one or two small hairs; two posteromedial hairs on abdominal segment VII. Siphunculi a thick dark brown sclerotic ring or arch, 20  $\mu$  wide, the pore 8-10  $\mu$  wide. Abdominal segment VIII (Ghosh & Raychaudhuri, 1973) with four long hairs. Cauda transversely elongate, almost not constricted at the base, with (Ghosh & Raychaudhuri, 1973) 10 hairs. Subanal plate bilobed. Gonapophyses two, each with four hairs.

Alate viviparous female.— Colour in life: Head, thorax and abdomen bluish black. Eyes, antennae, etc. black. Pterostigma of fore wings greyish black.

Macerated specimens.— (lacking, description quoted from the Van der Goot's manuscript ). Body length 1.80 mm, 2.2 times as long as it is wide. Antennae 630  $\mu$  long, 0.35 times as long as the body, with five segments; segment III, 290  $\mu$  long, with 20 rhinaria, 2.0 times as long as segment IV, and 2.5 times as long as V; segment IV with eight rhinaria, V with six.

Host plant records.— Van der Goot collected this aphid in 1916: Sidadap, Mt. Merbaboe (1000-1300 m), Tjepogo, Mt. Merapi (about 1000 m), Tjisoeroepan, Mt. Pandajan (about 1300 m), from *Cinnamomum verum* J.S. Presl (syn. *C. zeylanicum* Garc. ex Bl.) and sometimes on *C. iners* Reinw. ex Bl.

The aphids live on the lower side of the leaves, often fairly numerous, clustered close together along the midrib and the larger veins. Fairly large amounts of honeydew are excreted, causing sooty moulds on the upper surface of all leaves.

Alatae were collected in the middle of May 1916.

Etymology.— Heterotracha, having hairs of different lengths.

#### Genus *Glyphinaphis* Van der Goot, 1917 (figs. 311-317)

*Glyphinaphis* Van der Goot, 1917: 232 (type species *Glyphinaphis bambusae* Van der Goot, 1917).  
*Okajimaia* Suenaga, 1933: 249; Eastop & Hille Ris Lambers, 1976: 325 (synonymy).

Description (one species).— Apterous viviparous female.— In life: Body dull green or pale greenish brown, somewhat shiny, with 4-6 longitudinal rows of hairs. Without marginal or dorsal columns of wax, but the lower side floury.

Macerated specimens.— Body 1.0-1.8 mm long, 1.4-1.7 times as long as it is wide, the margins and the dorsum wholly sclerotic, pale brown divided into five parts: 1. head plus pronotum; 2. meso- plus metanotum; 3. abdominal tergite I; 4. abdominal tergite II-VII; 5. abdominal tergite VIII. Without marginal or dorsal wax gland groups, but the skin provided with wart-like projections, 6-10  $\mu$  wide and about 2-4  $\mu$  high. The head without horns, dorsally with stout hairs, 33-185  $\mu$  long, and about 6-12  $\mu$  wide close to the base; on other segments of the body dorsal hairs 22-224  $\mu$  long, the length of the hairs variable, short in some collections; ventrally stout hairs or normal hairs, e.g. 50  $\mu$  long and two  $\mu$  wide at the base; the ventral frontal part with an oval group of 10-20 wax glands. Antennae with four segments, 224-365  $\mu$  long, 0.17-0.24 times as long as the body, 0.67-0.88 times the distance between the outer margins of the eyes; the last antennal segment 3-5 times as long as the processus terminalis. The eyes with three ommatidia. Ultimate rostral segment 49-68  $\mu$  long, 0.62-0.87 times as long as the second tarsal segment of the hind leg; stylets 200-300  $\mu$  long.

The pronotum with two sturdy hairs, the mesonotum with 2-9, the metanotum with 4-9; oval groups of wax glands sometimes posterior to the coxae of the thoracic segments. The legs smooth, also the tarsi; tibia of the fore leg 0.47-0.61 times as long as the distance between the outer margins of the eyes. First tarsal segments of the fore- and midleg with four hairs, of the hind leg with two. Second tarsal segment of the hind leg with two apical hairs with expanded tips; empodial hairs of the hind leg 20-32  $\mu$  long. Abdominal tergite I with 4-9 hairs; II, 1-6; III, 3-7; IV, 2-5; V, 0-3; VI two; VII, 1-2. Tergite VIII transversely elongate with an almost straight posterior margin,

with 4-8 hairs, the two spinal hairs sturdy, 71-145  $\mu$  long. Siphunculi located dorsally on segment V, the pore 29-43  $\mu$  wide, and 80-120  $\mu$  away from the margin of the body. Cauda 77-124  $\mu$  wide at the base, the base plus knob 55-96  $\mu$  long; the knob triangular with rounded corners, 55-82  $\mu$  wide, 39-63  $\mu$  long, with diameter of the constriction 32-39  $\mu$ , with 9-13 hairs, the longest 53-102  $\mu$ . Subanal plate bilobed, with 12-14 hairs, the longest 69-98  $\mu$ . Subgenital plate two swellings with a dip in between, with two anterior and 7-17 posterior hairs. Gonapophyses two, each with 2-5 hairs.

First stage larvae of apterae 490-622  $\mu$  long. The antennae 267-285  $\mu$  long, 0.46-0.51 times as long as the body, 1.4-1.6 times the width of the head across the eyes; antennal segment III, 0.44-0.56 times as long as segment IV; segment IV, 1.9-2.3 times as long as its processus terminalis. Longest dorsal hairs 90-125  $\mu$ , short dorsal hairs 6-12  $\mu$ . Siphunculi are lacking.

Alate viviparous female.— According to Van der Goot (1917). In life: Black.

Macerated specimens.— 1.9 mm long, with short setae on the abdomen. Antennae with four segments, or maybe indistinctly with five, 750  $\mu$  long; segment III, 1.5 times as long as IV, with 33 linear rhinaria, segment IV with 16. The medial vein of the fore wing once branched. Cauda with a knob, constricted at the base. Subanal plate somewhat bilobed.

Etymology.— Glyphinaphis; "aphid cut in, carved"; name given by Van der Goot (1917).

**Glyphinaphis bambusae** Van der Goot, 1917  
(figs. 311-317)

*Glyphinaphis bambusae* Van der Goot, 1917: 232.

*Okajimaia japonica* Suenaga, 1933: 249; Eastop & Hille Ris Lambers, 1976: 207 (synonymy).

Types.— Lectotype (apterous viviparous female, here designated) bamboo, Pasoeroean, Java, Indonesia 1913, leg. P. v.d. Goot, no. 271-1, Det. P. v.d. Goot: *Glyphinaphis bambusae*. Paralectotypes seven apterae viviparae no. 271-2 to 271-8 with same data as lectotype, and 11 apterae viviparae from *Bambusa glaucescens* (Lamk) Munro, Salatiga, Java, Indonesia, 3.viii.1913, leg. P. v.d. Goot, no. 53, more or less bleached and fragmentary. Lectotype and paralectotypes in the collection at the Laboratorium voor Entomologie, Wageningen.

Apterous viviparous female.— In life (pls 31, 32): Body dull green (ivy- or olive green), pale greenish brown, somewhat shiny, with transversal grooves due to three segmental borders and also due to intermuscular plates, with 4-6 longitudinal rows of hairs, but sometimes the hairs less distinct. The head, the last abdominal segment and the legs more brownish; cauda whitish, floury; antennae yellowish, floury; lower side of the body floury. Eyes black. Larvae: head and pronotum a brownish plate, the rest of the body with 4-6 greyish spots in transverse rows, not shiny.

Macerated specimens.— (figs. 311-316; described from 20 specimens): Body ovate, 0.97-1.85 mm long, 1.4-1.7 times as long as it is wide; the dorsum wholly sclerotic, pale brown, divided into five parts: 1. head plus pronotum; 2. meso- plus metanotum; 3. abdominal tergite I; 4. abdominal tergites II-VII; 5. abdominal tergite VIII.

The skin is provided with wart-like projections, 6-10  $\mu$  wide and about 2-4  $\mu$  high,

circular or elliptical, not on the intermuscular plates, but somewhat radially arranged around them. The wart-like projections are lacking on the tubercles of marginal and dorsal hairs, and abdominal segment VIII, and are almost completely lacking in some specimens; symbionts which are usually present in the body in large amounts can be confused with the wart-like projections.

Head.— Head evenly pale brown, smooth or with wart-like projections, (fig. 312) the eyes situated dorsally at a distance of about  $40\ \mu$  from the margin of the head, distance between the outer margins of the eyes  $283\text{--}421\ \mu$ . Dorsally 4-7 frontal hairs, four hairs anterior to the eyes and two posterior, the hairs stout,  $33\text{--}185\ \mu$  long, about  $6\text{--}12\ \mu$  wide near the base, on a tubercle up to about  $25\ \mu$  high and  $30\ \mu$  wide near the base. The ventral frontal part (fig. 313) with a group of about 10-20 wax glands, frequently protruding beyond the dorsal margin up to even  $80\ \mu$ ; the glands are without thick walls, the surface with dots or densely with linear s-shaped structures; ventral hairs stout or normal, e.g.  $50\ \mu$  long and  $2\ \mu$  wide at the base. Antennae with four segments, the last segment sometimes darker,  $224\text{--}365\ \mu$  long, 0.17-0.24 times as long as the body, 0.67-0.88 times the distance between the outer margins of the eyes, and 1.3-1.6 times as long as the tibia of the fore leg; length of antennal segment III,  $74\text{--}151\ \mu$ , 0.9-1.2 times as long as IV, length of hairs  $10\text{--}35\ \mu$ ; segment IV,  $84\text{--}127\ \mu$  long, the processus terminalis  $20\text{--}40\ \mu$ , the segment 2.9-5.1 times as long as the processus terminalis; segment I-III almost smooth, IV with some spinulose imbrications. Eyes pale brown, at the outer sides with some brown, with three ommatidia. Ultimate rostral segment (fig. 314)  $49\text{--}68\ \mu$  long, 0.62-0.87 times as long as the second tarsal segment of the hind leg.

Thorax.— Prothorax fused with the head, on each side with two sturdy marginal hairs, the dorsum with two sturdy hairs; ventrally posterior to each of the coxae two wax gland groups. Meso- and metathorax fused, a transverse furrow with four intermuscular plates about in the middle; the mesonotum with 2-9 sturdy hairs, the metanotum with 4-9. Legs evenly pale brown, smooth, also the tarsi. Tibia of the fore leg  $172\text{--}244\ \mu$  long, 0.47-0.61 times as long as the distance between the outer margins of the eyes. First tarsal segments of the fore- and midleg with four hairs, of the hind leg with two,  $30\text{--}50\ \mu$  long; second tarsal segment of the hind leg 0.22-0.27 times as long as the tibia of the hind leg, and 0.19-0.23 times as long as the distance between the outer margins of the eyes, with two dorsoapical hairs,  $38\text{--}48\ \mu$  long, with expanded tips,  $2\text{--}4\ \mu$  wide. Empodial hairs of the hind leg  $20\text{--}32\ \mu$  long. Length of segments of the hind leg: femur with trochanter  $212\text{--}349\ \mu$ , tibia  $253\text{--}397\ \mu$ , first tarsal segment  $27\text{--}37\ \mu$ , second tarsal segment  $65\text{--}90\ \mu$ ; the tibia is 1.10-1.20 times as long as the femur, and 0.74-0.95 times the distance between the outer margins of the eyes.

Abdomen.— Abdominal segment I free, dorsally with 4-9 sturdy hairs. Segments II-VII fused, II dorsally with 1-6 sturdy hairs, III with 3-7; IV, 2-5,  $22\text{--}193\ \mu$  long, ventral hairs thin,  $20\text{--}40\ \mu$  long, V dorsally with 0-3 sturdy hairs, VI with two, VII with 1-2. Segments I-VII each with one sturdy marginal hair, of segment VI,  $47\text{--}224\ \mu$  long, of VII,  $71\text{--}167\ \mu$ ; in specimens with long sturdy hairs, the marginal hair of VI is longer than that of VII, but in specimens which show shortening of sturdy hairs, the marginal hairs of segments I-VI are shorter than those of VII. Abdominal segment VIII free, transversely elongate with an almost straight posterior margin, with 4-8 hairs, the two spinal hairs sturdy,  $71\text{--}145\ \mu$  long. Siphunculi located dorsally on segment V, the pore at a distance of  $80\text{--}120\ \mu$  from the margin of the body; a cone the

same colour as the surroundings, with concentric imbrications, about 75  $\mu$  wide at the base and 20-40  $\mu$  high, the pore a brown ring, diameter 29-43  $\mu$ . Cauda (fig. 315) 77-124  $\mu$  wide near the base, 55-96  $\mu$  long (base plus knob), with a triangular knob with rounded corners, 55-82  $\mu$  wide, 39-63  $\mu$  long, with a diameter of the constriction 32-39  $\mu$ , with 9-13 hairs, the longest 53-102  $\mu$ . Subanal plate bilobed, with 12-14 hairs, the longest 69-98  $\mu$ . Subgenital plate (fig. 316) two blisters with a dip in between, the two anterior hairs, 35-63  $\mu$  long, are located on the slope of this dip, and sometimes one smaller yet in the middle of a blister; the posterior hairs, 30-59  $\mu$  long, situated along the posterior side of the blisters. Gonapophyses two, each with 2-5 hairs, the longest 8-20  $\mu$ . Spiracles on segments II, III, IV, V, VI and VII.

Alate viviparous female.— In life: Head and thorax black. Abdomen bluish black. Eyes, antennae, legs, siphunculi and cauda wholly black. Pterostigma of the fore wing greyish black, all veins black (Van der Goot, 1917).

Macerated specimens.— (Van der Goot, 1917). Body 1.90 mm long, 2.6 times as long as it is wide, with only short setae on the abdomen. Antennae with four segments, or indistinctly maybe with five segments, 750  $\mu$  long; segment III 1.5 times as long as IV, with 33 linear rhinaria, IV with 16 rhinaria. Siphunculi, cauda, subanal plate, gonapophyses and legs as apterous viviparous female. Mesothorax at the anterior margin with two small projections.

First stage larva (fig. 317) of apterous viviparous female (description of one specimen): Body length 520  $\mu$  (490-620  $\mu$ ), length of head plus pronotum 185  $\mu$ , width of prothorax 216  $\mu$ , head across the eyes 188  $\mu$  wide (174-210  $\mu$ ); the head dorsally brownish, with two frontal hairs 88  $\mu$  long, four hairs just anterior to the eyes, 116  $\mu$  long, and two posterior hairs, about 10  $\mu$  long; ventrally, dorsal to the antennae one hair, 10  $\mu$  long, and in the medial area four hairs, about 55  $\mu$  long. Antennae with four segments, 267  $\mu$  long; segment III, 71  $\mu$  long; IV, 129  $\mu$  long with the processus terminalis 65  $\mu$  long; both segments with spinulose imbrications; length of hair on segment II, 52  $\mu$ ; on III, 35  $\mu$ . Prothorax with a marginal hair and two on the pronotum, 84  $\mu$  long. Mesothorax with a marginal hair and two dorsal hairs, 125  $\mu$  long. Metathorax with a marginal hair, 110  $\mu$  long, and two dorsal hairs, 6  $\mu$  long. Tibia of the fore leg 141  $\mu$  long, length of distal hairs of the tibia of the fore leg 30  $\mu$  long, of the hind leg 48  $\mu$ . All first tarsal segments with two hairs, about 45  $\mu$  long. Two dorsoapical hairs of the second tarsal segment of the hind leg with expanded tips, 40  $\mu$  long, other apical hairs smaller and acute. Wax glands are lacking ventrally on the head and thorax. Abdominal segments I, III and V with only tiny marginal and dorsal hairs, but II, and VI with a sturdy marginal, and two sturdy dorsal hairs; IV with only sturdy marginal hairs, VII with a marginal hair, 20  $\mu$  long, and two dorsal hairs 88  $\mu$  long, VIII with two hairs, 22  $\mu$  long. Cauda with two hairs, about 15  $\mu$  long. Siphunculi absent.

Host plant records.— Specimens were collected in Java from the following host plants, in the places and on the dates indicated, while the collectors are indicated by numbers between parentheses: Van der Goot or Van der Goot (1917), (1), in the collection at the Laboratorium voor Entomologie, Wageningen, or lost; F.W. Rappard (2), and Prof. P. Büchner (3), both in the collection at the British Museum (Natural History), London; and D. Noordam (4), in the collection at the Rijksmuseum van Natuurlijke Historie, Leiden. Bamboo, Pasoeroean (or Kepoeh, 200 m), ii.1913 (1); *Bambusa glaucescens* (Lamk) Munro, Salatiga (580 m), 3.viii.1913 (1); Bogor (250 m),

xii.1914 (1); bamboo, Bogor, 4.vi.1918 and 25.vii.1918 (1); bamboo, Gombeng (Banjoe-wangi), 250 m, 9.xii.1949 (2); *Shibataea kumasasa* (Steud.) Makino, Punten (1200 m), 8.iv.1951 (2); bamboo, Bogor, 1.vi.30.vii.1956 (3); *Bambusa arundinacea* (Retz.) Willd., Bogor, Kebun Raya, 1.iv.1975 (4); bamboo, Sindanglaya (1100 m), 29.iv.1975, and 12.vi.1975 (4); bamboo, Mt. Salak (1000 m), 14.vi.1975 (4); bamboo Bogor, 21.vi.1975 (4); bamboo, Sindanglaya (1100 m), 21.x.1975 (4); *Bambusa glaucescens* (Lamk) Munro, Cibodas-Lembang, 11.xi.1975 (4); bamboo, Ciawi-Bogor, 22.xi.1975 (4); *Bambusa schizostachyoides* Kurz, Bogor, Kebun Raya, 27.ii.1976 (4); *Phyllostachys sulphurea* A. et Ch. Riv., Cibodas (1400 m), 27.vi.1976 (4); *Bambusa glaucescens* (Lamk) Munro, Kaliurang-Mt. Merapi (900 m), 5.viii.1976 (4); bamboo, Sindanglaya (1100 m), 6.ix.1976 (4); *Bambusa arundinacea* (Retz.) Willd., Bogor, Kebun Raya, 10.ix.1976, (4); *Dendrocalamus asper* Back., Bogor, Kebun Raya, 22.xii.1976 (4); bamboo, Sindanglaya (1100 m), 12.ii.1976 (4); *Bambusa glaucescens* (Lamk) Munro, Bogor, 15.v.1977 (4); bamboo, Lawang (500 m), 28.xii.1977 (4); *Schizostachyum brachycladum* (Kurz) Kurz, Bogor, Kebun Raya, 6.i.1978 (4).

The aphids live on young culms and branches, especially on nodes and sheaths, sometimes also spreading from there to lower and upper sides of developing top leaves.

Alatae were collected at the beginning of ii.1913, and 3.viii.1913.

Etymology.— Bambusae, from *Bambusa*, one of the genera of bamboos.

#### Genus *Mesothoracaphis* nov. (figs. 318-327)

Type species *Thoracaphis rappardi* Hille Ris Lambers & Takahashi, 1959.

Description (one species).— Apterous viviparous female.— In life: A brownish black box, dorsally somewhat shiny, the margins dull, white, similar to hoar frost; the ventral side flat, shiny and striped.

Macerated specimens.— Body a brown box with a black outline, the dorsum flat, but vaulted in the middle, consisting of: (1) prosoma, the fused head, thorax and abdominal tergite I; (2) the complex of tergites II-VII; and (3) the dorsally free tergite VIII. The prosoma is 3.8-4.3 times as long as complex II-VII, and 11-15 times as long as tergite VIII. Length of the body 950-1140  $\mu$ , 1.2-1.4 times as long as it is wide, smooth, but with some pustules and numerous internal thickenings close to the three transverse folds, and to intersegmental muscular plates; wax gland groups are lacking. The head without horns or dagger hairs. Anterior to the eyes along the dorsal margin six hairs, between the eyes 2-4 hairs; posterior to the eyes on each side 10-12 hairs, 60-90  $\mu$  long; besides these only hairs in the medial area, 3-10 on the pronotum, 4-10 on the mesonotum, 2-6 on the metanotum, and 0-1 on abdominal tergite I, 20-100  $\mu$  long. Antennae with three segments, bent sideways on segments I and II, 76-90  $\mu$  long, 0.07-0.09 times as long as the body; segment III, 1.2-1.5 times as long as II, with one rhinarium located 2-15  $\mu$  from the tip. Eyes dorsal at the margins of the prosoma, with three ommatidia. Ultimate rostral segment without accessory hairs, 96-106  $\mu$  long, 1.7-1.9 times as long as the second tarsal segment of the hind leg; stylets 700-900  $\mu$  long. Spiracles on each side one between fore- and midleg, and one

between mid- and hind leg. The legs brown, smooth, the segments strongly sclerotized; tibia of the fore leg 76-92  $\mu$  long, 0.23-0.26 times as long as the distance between the outer margins of the eyes. First tarsal segments of the fore- and midleg with three hairs, of the hind leg with two. The complex of tergites II-VII dark brown, on each side with six hairs, 50-90  $\mu$  long; frequently a tiny hair is present anterior or posterior to the siphunculi, but other hairs are lacking on the complex. Siphunculi with a pore, 20-25  $\mu$  diameter. Abdominal tergite VIII, a dark brown plate with a transverse ridge with 3-6 hairs, the spinal hairs 108-150  $\mu$  long; posterior to the ridge and about 18  $\mu$  below a pale brown crenulated crest. Cauda brown, transversely elongate, a knob with a constriction, with 10-14 hairs, the longest 65-69  $\mu$ . Subanal plate brown, strongly bilobed, with 18-23 hairs, the longest 76-90  $\mu$ . Subgenital plate pale brown, with two anterior hairs, and 12-17 posterior hairs. Gonapophyses two, without hairs.

First stage larva of apterae with pale brown fused head plus prothorax, and pale brown fused abdominal segments I-VII; meso- and metathorax with a marginal and a dorsal sclerite. Antennae with four segments. Siphunculi lacking or indistinct. On each side two spiracles.

Alate viviparous female.—Macerated specimen: Body length 1.62 mm. The head smooth, without horns or dagger hairs, with three pairs of hairs anteriorly, and a posterior row of four hairs, up to 80  $\mu$  long. Antennae with five segments, 0.26 times as long as the body, and 1.1 times the width of the head across the eyes, the processus terminalis 8-12  $\mu$  long. Antennal segments III-V with ring-shaped secondary rhinaria; between the rhinaria are usually three concentric spinulose imbrications; the primary rhinarium of segment IV, moulded with the secondary to a complex structure, but that of segment V is separate and located distally; segment III with 20-23 annular rhinaria, IV with 7-9, V with 4-5. The last rostral segment 101  $\mu$  long, 1.22 times as long as the second tarsal segment of the hind leg, without accessory hairs; length of stylets 320  $\mu$ . Eyes compound. Femora, tibiae and second tarsal segments with spinulose imbrications; the tibia of the fore leg 259  $\mu$  long, 0.69 times as long as the width of the head across the eyes; first tarsal segments of the fore- and midleg with three hairs, of the hind leg with two. All four apical hairs of the second tarsal segments of the midleg, and presumably of the hind leg with expanded tips, the dorsoapical hair 48  $\mu$  long, the tip 4-5  $\mu$  wide; the empodial hair of the hind leg 24  $\mu$  long. Abdominal segment I on each side with two marginal hairs, 60-70  $\mu$  long, and with two spinal hairs, 50  $\mu$  long; II and III each with one marginal hair, 72-108  $\mu$  long, and without dorsal hairs; segments IV-VI marginally fused together, a plate with three hairs, 70-90  $\mu$  long, hairs on the tergites are lacking; siphunculi are on this plate, usually with one hair, 18-20  $\mu$  long, diameter of the pore 30  $\mu$ ; segment VII marginally with a plate with one hair, 90  $\mu$  long, the tergite without hairs; tergite VIII with eight hairs, the longest 100  $\mu$ . Distinct spiracles on segments II, III, IV and V. Cauda transversely elongate, without a constriction, with 15 hairs, the longest 57  $\mu$ . Subanal plate strongly bilobed, with 27 hairs, the longest 65  $\mu$ . Subgenital plate with 17 anterior and 15 posterior hairs. Gonapophyses two, each with six hairs, 10  $\mu$  long.

Embryos in the only alata are similar to those in apterae.

Etymology.—Mesothoracaphis, middle *Thoracaphis*, name intended by Dr D. Hille Ris Lambers to be given to the genus, with the type species *Thoracaphis rappardi* Hille Ris Lambers and Takahashi, 1959.

**Mesothoracaphis rappardi** (Hille Ris Lambers & Takahashi, 1959) comb. nov.  
(figs. 318-327)

*Thoracaphis rappardi* Hille Ris Lambers & Takahashi, 1959: 1.

Types.— Cotypes, 27 apterous viviparous females. *Viscum articulatum*, Java, Soekowono, 9.xii.1948, leg. F.W. Rappard no. 101 in the collection at the British Museum (Natural History), London.

Apterous viviparous female.— In life (pl. 33): Body a brownish black box, dorsally somewhat shiny, flat, but in the middle vaulted, with four transverse furrows; the margins perpendicular, dull, white, similar to hoar frost. Legs and antennae reddish brown. Cauda and subanal plate pale brown, the last segment in front of these dark reddish brown. Ventral side flat, shiny and striped. Eyes and siphunculi black. Larvae dirty greenish brown, head more brown, legs dirty white, floury with wax.

Macerated specimens.— (figs. 318-320; described from about 20 specimens). Body a box with a broadly elliptical dorsum, 950-1140  $\mu$  long, 1.2-1.4 times as long as it is wide, with three parts separated from each other by a colourless membrane: (1) head plus thorax plus abdominal tergite I (prosoma), (2) the complex of tergites II-VII, and (3) the dorsally free tergite VIII; (1) is 3.8-4.3 times as long as (2), and 11-15 times as long as (3); the prosoma with a vault in the middle, running from between the eyes up to the distal end of the prosoma, being highest, about 100-150  $\mu$ , at the thorax; the margins perpendicular, about 400  $\mu$  high, the ventral side flat, almost as elliptical as the dorsum. The dorsum, the sides and the outer margins of the venter is a rigid structure, brown, sclerotic, the rest of the venter is pale brown.

Prosoma. Margin of the dorsal prosoma (fig. 320) posterior to the eyes crenulated with thickenings of the edge, separated by a colourless membrane, up to six  $\mu$  wide, from the perpendicular margins. Eyes with three ommatidia, at the margin of the dorsal prosoma, distance between the outer margins 335-365  $\mu$ . Surface of the dorsal side smooth, and so the vault in the middle, and a slight lowering between vault and margin easily overlooked; a median transverse fold between pro- and mesonotum, between meso- and metanotum, and a less distinct fold between metanotum and abdominal tergite I, all three with some low pustules and internal thickenings; a colourless spot in the middle of each fold, and a colourless tiny stripe in the spinal area of the pro- and mesonotum. Intersegmental muscular plates with paler brown ovals and darker surroundings observable, sometimes as sunken areas. Anterior to the eyes along the dorsal margin six hairs, 57-65  $\mu$  long, between the eyes 2-4 hairs. Margin of the dorsal plate posterior to the eyes on each side with 10-12 hairs, about 60-90  $\mu$  long; besides these only hairs in the medial area on the vault, 3-10 on the pronotum, 4-10 on the mesonotum, 2-6 on the metanotum, and 0-1 on abdominal tergite I, the longest hairs 70-100  $\mu$ , the shortest 20-50  $\mu$ . Antennae (fig. 319) inserted about 75  $\mu$  below the dorsum, 76-90  $\mu$  long, 0.07-0.09 times as long as the body, and 0.23-0.25 times as long as the distance between the outer margins of the eyes, with three segments, fused together internally, and segment I basally with the head; segment I about 35  $\mu$  long, II protruding I about 15  $\mu$ , III protruding II about 35  $\mu$ ; one rhinarium located 2-15  $\mu$  from the tip, the other usually not observable. Ultimate rostral segment 96-106  $\mu$  long, 1.7-1.9 times as long as the second tarsal segment of the hind leg; stylets 700-900  $\mu$  long. Legs inserted at the sides, about 250  $\mu$  below the



margin of the dorsum, brown, smooth, the segments strongly sclerotized; tibia of the fore leg 76-92  $\mu$  long, 0.23-0.26 times as long as the distance between the outer margins of the eyes. Length of hairs of the tibia of the hind leg 28-40  $\mu$ . First tarsal segments of fore- and midleg with three, of the hind leg with two hairs, of the hind leg about 30  $\mu$  long; the second tarsal segment with two dorsoapical hairs with slightly expanded tips, 30-40  $\mu$  long. The perpendicular margins of the prosoma with hairs and roundish or oblong pustules, 2-3  $\mu$  high. The margins proceed ventrally with a brown sclerotic curve to the almost colourless, flat lower side, which extends from the head to just posterior to the coxae of the hind legs; the ventral plate with three pairs of intersegmental muscular plates, with a transverse furrow in between and the surface shows a pattern with radial or somewhat concentric fine stripes, with about six hairs.

Abdominal segments II-VII dorsally dark brown, fused, about 425  $\mu$  wide, and 193  $\mu$  long, at the anterolateral corners fused with the prosoma over a distance of about 50  $\mu$ , but everywhere else connected by membranes only; the anterior border is separated by a colourless membrane from the prosoma, 6-10  $\mu$  wide in the middle; the lateral sides and the posterior margin are separated from the surroundings by membranes which are frequently hidden under the complex; the plate itself has, on the lateral side, a pale brown crest about 15  $\mu$  wide, with five folds running parallel to the side of the complex; the posterior margin is emarginated about 18  $\mu$ , with a crest not wider than 6  $\mu$ ; the submarginal part of the lateral and posterior part of the plate is raised above the crest, and is observable as a dark brown band, due to internal thickenings. Along the lateral sides a row of six hairs, 50-90  $\mu$  long. Frequently, a tiny hair is present anterior or posterior to the siphunculi; internal thickenings are observable on both sides of the siphunculi, and proceed to the anterolateral corners; six muscle plates on each side are present between these thickenings. Siphunculi located on abdominal segment V, with a pore, 20-25  $\mu$  diameter, raised about 10  $\mu$ . Abdominal segment VIII free, a dark brown plate, e.g. 228  $\mu$  wide and 67  $\mu$  long, with a transverse ridge with 3-6 hairs, the spinal 108-150  $\mu$  long; posterior to this ridge, and about 18  $\mu$  below a pale brown crenulated crest. The venter curves upwards behind the coxae of the hind leg and rises almost perpendicularly, encircling the sides of the abdominal segments II-VII complex and behind segment VIII; on this broadly rounded wall are five transverse thickened furrows with, in between, four or five rows of some hairs, about 50  $\mu$  long. Cauda brown, a transversely elongate knob, e.g. 63  $\mu$  wide, 22  $\mu$  long with a diameter of the incision of 49  $\mu$ ; width of the knob 62-71  $\mu$ , with 10-14 hairs, the longest 65-69  $\mu$ . Subanal plate brown strongly bilobed, with 18-23 hairs, the longest 76-90  $\mu$ . Subgenital plate pale brown, with two anterior hairs, 35-50  $\mu$  long, and 12-17 posterior hairs, 43-53  $\mu$  long. Gonapophyses two, pale brown, without hairs.

Alate viviparous female.— In life: A pale specimen, green with red eyes. Larvae dirty dark greenish brown, with crenated margin and a hair on each crena.

Macerated specimens.— (figs. 321-326; one bleached specimen). Body length 1.49 mm, 2.2 times as long as wide.

Head.— (fig. 321). Head dorsally smooth, width across the eyes 375  $\mu$ , with three pairs of hairs, and a posterior row of four hairs, up to 80  $\mu$  long; ventrally on one side four hairs, on the other six. Antennae with black rings, with five segments, 425  $\mu$  long, 0.26 times as long as the body, and 1.1 times the width of the head across the

eyes; segment I dorsally with spinulose imbrications, II with wrinkles; segments III-V (fig. 322) with ring-shaped secondary rhinaria, the rings are not closed on the dorsal side, with a space of 8-40  $\mu$ ; between the rhinaria are usually three concentric spinulose imbrications, dorsally with interconnections; the rhinaria are 3-4  $\mu$  wide. The primary rhinarium of segment IV is between the annular rhinaria, and is moulded with these to a complex structure, but that of segment V is located distally; segment III with 20-23 annular rhinaria, IV with 7-9, V with 4-5; hairs of segment III, 22  $\mu$  long. Length of segment III, 216  $\mu$ , 2.8 times as long as IV, 3.8 times as long as V, and 1.6 times as long as IV plus V; segment IV, 78  $\mu$  long, 1.4 times as long as V; and V, 57  $\mu$  long with the processus terminalis 8-12  $\mu$  long. The last rostral segment (fig. 323) 101  $\mu$  long, 1.22 times as long as the second tarsal segment of the hind leg, without accessory hairs; length of stylets 320  $\mu$ . Eyes compound.

Thorax.— Prothorax at each margin three hairs, and dorsally two hairs. Fore wing (fig. 324) cubitus at the base at a distance of about 50  $\mu$  from the anal vein. Femora, tibiae and second tarsal segments with spinulose imbrications; the tibia of the fore leg 259  $\mu$  long, 0.69 times as long as the width of the head across the eyes, longest hairs of the hind tibia 40  $\mu$ ; chaetotaxy of first tarsal segments 3, 3, 2, the lateral hairs 2.3 times as long as the middle; length of hair of the first tarsal segment of the hind leg 49  $\mu$ ; four apical hairs of the second tarsal segment of the midleg, and presumably also of the hind leg (fig. 325) with expanded tips, the dorsoapical hair 48  $\mu$  long, the tip 4-5  $\mu$  wide; length of the empodial hair of the hind leg 24  $\mu$ . Length of the hind segments: femur fused with the trochanter 281  $\mu$ , tibia 395  $\mu$ , 1.4 times as long as the femur, and 1.05 times the width of the head across the eyes; first tarsal segment 37  $\mu$  long, second tarsal segment 83  $\mu$ .

Abdomen.— (fig. 326). Abdominal segment I on each side a small plate with some wrinkles, with two marginal hairs, 60-70  $\mu$  long, the tergite with two spinal hairs, 50  $\mu$  long; segments II-III each with a marginal plate, with one hair, 72-108  $\mu$  long; segments IV-VI marginally fused together, a plate with spinulose imbrications, each with three hairs, 70-90  $\mu$  long, hairs on the tergites are lacking; siphunculi are on this plate on segment V, with concentric wrinkles, on the anterior, rarely on the lateral side, usually with one hair, 18-20  $\mu$  long, diameter of the pore about 30  $\mu$ ; segment VII with a marginal plate with wrinkles and spinulose imbrications, with one hair, 90  $\mu$  long, the tergite without hairs; tergite VIII with spinulose imbrications and eight hairs, the longest 100  $\mu$ . Cauda transversely elongate, 80  $\mu$  wide, 20  $\mu$  long, without a constriction, with 15 hairs, the longest 57  $\mu$ . Subanal plate strongly bilobed, with 27 hairs, the longest 65  $\mu$ . Subgenital plate with 17 anterior hairs, spread on the plate, the longest 43  $\mu$ , and 15 hairs along the posterior margin, 22  $\mu$  long. Gonapophyses two, each with six hairs, 10  $\mu$  long.

First stage larva of apterous viviparous female (fig. 327; description of one specimen): Body length 565  $\mu$  (535-645  $\mu$ ), 1.7 times as long as it is wide, head fused with the prothorax; mesothorax and metathorax free, abdominal segments I-VII pale brown, fused, and segment VIII free, pale brown. Length of head plus pronotum 232  $\mu$ , width of prothorax 303  $\mu$ ; head across the eyes 212  $\mu$ , pale brown, with two frontal hairs, 57  $\mu$  long, and four hairs in a row between the eyes, 72  $\mu$  long; ventrally two pairs of hairs, 50  $\mu$  long. Antennae with four segments, 186  $\mu$  long, segment III, 78  $\mu$ ; IV, 53  $\mu$ , with smooth imbrications; length of hair on segment II, 43  $\mu$ , lacking on III, and four setae apically on IV, 20-53  $\mu$  long. Eyes brown, with about 10 tubercles.

Prothorax pale brown with two marginal hairs, 69  $\mu$  long, and two hairs on the pronotum, 67  $\mu$  long. Meso- and metathorax marginally with a pale brown plate each with two hairs about 55  $\mu$  long; the mesonotum with two hairs on a pale brown plate, 72  $\mu$  long, the metanotum the same but the hairs 12-60  $\mu$  long. Ventrally on each side of the prothorax and the metathorax a spiracle. Tibiae distally with some spinulose imbrications, the fore tibia 110  $\mu$  long, the tibia of the hind leg with a distal hair 36  $\mu$  long, but next to this with two spines, the largest 10  $\mu$  long, and three  $\mu$  wide at the base. All first tarsal segments with two hairs, about 50  $\mu$  long. Second tarsal segment of the hind leg with two dorsoapical hairs with expanded tips, 53  $\mu$  long, the lateral hairs smaller, almost acute.

Abdominal segments I-VII fused, pale brown with slightly darker linear intersegmental plates; siphunculi lacking, but a slightly paler spot at their location, the tergites smooth, but with spinulose imbrications, increasing from segments IV to VII; each segment with a marginal hair 53-72  $\mu$  long, but on V, 27  $\mu$ , dorsal hairs are lacking; segment VIII free, with broadly rounded posterior margin, with spinulose imbrications, and two hairs, 82  $\mu$  long. Cauda with two hairs, 50  $\mu$  long. Spiracles on four abdominal segments, II-V.

Embryos in the alata are similar to those in apterae.

Host plant records.— Specimens were collected in Java from Loranthaceae: *Dendrophthoë pentandra* (L.) Miq. (mentioned in the manuscript *Loranthus pentandra*), Salatiga Mt. Pajong (600 m), 1916, leg. Van der Goot, in his manuscript; *Viscum articulatum* Burm.f., Soekowono Ketjil (700 m), Bondowoso, 9.xii.1948, leg. F.W. Rappard; *Dendrophthoë pentandra* (L.) Miq., Sindanglaya (1100 m), 30.xi.1977, leg. D. Noordam.

The aphids were found by Van der Goot on younger shoots of *Dendrophthoë*, by the author on wholly lignified branches; Rappard found the aphid on young specimens of *Viscum* plants.

Alatae were collected 2.iv.1916, 9.xii.1948, and 30.xi.1977.

Etymology.— Rappardi, named after Dr F.W. Rappard who collected this aphid described by Hille Ris Lambers & Takahashi (1959).

### Genus *Metanipponaphis* Takahashi, 1959 (figs. 328 - 343)

*Metanipponaphis* Takahashi, 1959: 5 (type species *Metanipponaphis rotunda* Takahashi, 1959).

Description.— Apterous viviparous female (one species).

Macerated specimens.— Body brown with black margins, a box with a flat oval dorsum, consisting of: (1) the head, thorax and abdominal segments I-VII fused, but the lateral part of segments II-VII free, the head, thorax and abdominal segments I and II dorsally with pustules, III-VII almost smooth; (2) the free segment VIII. Length of head, thorax and abdominal tergite I e.g. 3.1 times as long as tergites II-VII, and 8.8 times as long as tergite VIII. Length of the body 1.6-1.8 mm, 1.4-1.6 times as long as it is wide. The head without horns or dagger hairs, and as other parts of the body without wax gland groups; the head densely covered with pustules, 12-20  $\mu$  wide at the base, 4-6  $\mu$  high, with about six hairs, 25-40  $\mu$  long. Antennae with three segments, bent sideways on segments I and II, 220-235  $\mu$  long, 0.13-0.14 times as long as

the body, and 0.38-0.43 times the distance between the outer margins of the eyes; segment III is 4-5 times as long as II; the distal rhinarium located 12-23  $\mu$  from the tip, the other 53-76  $\mu$ . Eyes on the anterior bend of the head, about 250  $\mu$  below the flat dorsal side, with three ommatidia. Ultimate rostral segment without accessory hairs, 63  $\mu$  long; length of the stylets 440-495  $\mu$ . Spiracles on each side, one between fore- and midleg, and one between midleg and hind leg. The legs brown, the tibia of the fore leg 124  $\mu$  long, 0.21-0.23 times as long as the distance between the outer margins of the eyes. On the dorsal plate pustules observable as a half ring, ellipse or horse-shoe, 6-16  $\mu$  wide and at a distance from each other of 6-12  $\mu$ ; near the margins of the dorsum of mesothorax, metathorax and abdominal segment I the pustules more resemble pieces of a jigsaw puzzle. The dorsal plate with four pairs of intersegmental muscular plates; posterior to the eyes and anterior to abdominal segment II on each side 6-7 hairs; abdominal segments II-VII on each side six marginal hairs. In the medial area the prothorax with 6-7 hairs, mesothorax 10-13, metathorax 5-8, abdominal tergite I, 3-5; II, 0-2; III, 0-1; IV-VI without hairs, and VII sometimes with one, the hairs 10-50  $\mu$  long. Tergites II-VII with a thickened lateral and posterior margin, and laterally also with a crest, radially striped due to small ridges. Siphunculi with a pore, 23-25  $\mu$  wide. Abdominal segment VIII the sides and posterior margin with a thickened ridge, and with a radially striped crest, about 20  $\mu$  wide; usually two spinal hairs observable, 42-52  $\mu$  long. The dorsal plate on the lateral sides connected with the almost perpendicular sides, densely covered with pustules. Cauda with a transversely elongate knob, with about 18 hairs, about 50  $\mu$  long. Subanal plate strongly bilobed. Subgenital plate and gonapophyses obscured by covering parts. The venter with a black margin and an almost colourless central area, smooth and without hairs.

Embryo of aptera: Antennae with three segments, 223  $\mu$  long, one of the apical hairs of segment III up to 105  $\mu$  long. Oval groups of wax glands on the head, and marginally and spinally on thoracic and abdominal segments, but lacking on abdominal segment VIII.

Ventral to the marginal wax gland groups of the abdomen, and on abdominal tergite VIII dotted areas. Siphunculi are lacking. Spiracles on each side two on the thorax between the legs.

Alate viviparous female.— Macerated specimen: Body length 2.24 mm. The head smooth, without horns or dagger hairs, with three pairs of hairs anteriorly, and a posterior row of four hairs, 33-55  $\mu$  long. Antennae with five segments, 0.32 times as long as the body, and 1.5 times the width of the head across the eyes, the processus terminalis 20  $\mu$  long. Antennal segments III-V with ring-shaped secondary rhinaria; the primary rhinarium on segment IV is moulded with an annular rhinarium, but on segment V a primary rhinarium is observable distally; segment III with 15, IV with seven, and V with three annular rhinaria. The last rostral segment 108  $\mu$  long, 0.70 times as long as the second tarsal segment of the hind leg, without accessory hairs; length of the stylets 380  $\mu$ . Eyes compound. Femora, tibiae and second tarsal segments with spinulose imbrications; the tibia of the fore leg 485  $\mu$  long, 1.02 times as long as the width of the head across the eyes; first tarsal segments of the fore- and midleg presumably with three hairs, of the hind leg with two. Abdominal segments I-VII marginally with a brown plate with spinulose imbrications, and IV-VII also with darker brown warts, each plate with one hair; tergites I and II colourless, III-VI

each with a pair of pale brown spots, all without hairs; tergite VII with one pale brown spot with one hair; tergite VIII pale brown, with seven hairs, the spinal hairs 100  $\mu$  long. Siphunculi located on segment VI, joined with the marginal sclerite, without hairs. Cauda transversely elongate with 12 hairs, the longest 100  $\mu$ . Subanal plate strongly bilobed, with 17 hairs, the longest 92  $\mu$ . Subgenital plate with 19 anterior and 18 posterior hairs. Gonapophyses two, each with 9-12 hairs.

Embryo from alata 715  $\mu$  long, 1.4 times as long as it is wide. Arrangement of hairs on the body as in apterae, but length of the hairs 20-45  $\mu$ . Wax gland groups are lacking, the skin finely and indistinctly marbled. Siphunculi located on segment VI.

Etymology.— *Metanipponaphis*, new but related *Nipponaphis*, name given by Takahashi (1959).

***Metanipponaphis vandergooti* spec. nov.**  
(figs. 328-343)

Types.— Holotype (apterous viviparous female) from wranak - *Lithocarpus sundaicus* (Bl.) Rehd., Pekasirie, Java, Indonesia, no. 301-1, 14.viii.1919, leg. P. v.d. Goot, det. P. v.d. Goot: *Thoracaphis* spec. Paratypes: 12 apterae viviparae, one alata vivipara and one larva alata vivipara, partly fragmentary. Holotype and paratypes in the collection at the Laboratorium voor Entomologie, Wageningen.

Van der Goot collected this species, and apart from mounted specimens only the data on a label are available.

Apterous viviparous female.— Macerated specimens.— (figs. 328-330; described from 13 fragmentary specimens). Body brown with black margins, a box with a flat oval dorsum, 1.65-1.80 mm long, 1.4-1.6 times as long as it is wide, with steep sides, about 600  $\mu$  high. Head, thorax and abdominal segment I dorsally fused: segment I distinctly defined from II-VII by a marginal furrow only; II-VII with thickened lateral margins and a lateral crest, and VII with a thickened posterior margin; segment VIII free, with thickened lateral and posterior margins and a crest. Length of head plus thorax plus abdominal segment I, 1140  $\mu$ , of II-VII, 354  $\mu$ , of VIII, 130  $\mu$ .

The head dorsal to the eyes rises about 250  $\mu$ , bending gradually to the flat dorsal side, densely covered with pustules, 12-20  $\mu$  wide at the base, 4-6  $\mu$  high, with about two hairs on the frons between the antennae, and four between the eyes, about 35  $\mu$  long. Eyes with three ommatidia, distance between the outer margins 527-587  $\mu$ . Antennae inserted about 400  $\mu$  below the dorsum, 150  $\mu$  below the eyes, with three segments, bent sideways on segments I and II, 220-235  $\mu$  long, 0.13-0.14 times as long as the body, and 0.38-0.43 times the distance between the outer margins of the eyes; the segments are fused together, and segment I basally with the head, segment I about 40-45  $\mu$  long, II, 35-40  $\mu$ ; III, 165-180  $\mu$ ; the distal rhinarium located 12-23  $\mu$  from the tip, the other 53-76  $\mu$ ; length of hair on segment I, 8-18  $\mu$ ; on II, 10-14  $\mu$ ; on III only four apical setae, 14-20  $\mu$  long. Ultimate rostral segment about 63  $\mu$  long, length of the stylets 440-495  $\mu$ . On the dorsal plate pustules observable as a half ring, ellipse or horseshoe, 6-16  $\mu$  wide and at a distance from each other of 6-12  $\mu$ ; in some areas, especially near the margins of the dorsum of mesothorax, metathorax and abdominal segment I, the pustules (fig. 329) are more angular discs with sunken paler furrows, rather like the pieces of a jigsaw puzzle. The dorsal plate with four

pairs of intersegmental muscular plates observable as subsidences with darker brown ovals in the centre, and radiating pustules; these plates are marks of the borders between head, pronotum, mesonotum, metanotum and abdominal segment I; a pair of smaller muscular plates is observable on the head in the middle between the eyes. The margin of the dorsal plate of the prothorax with one or two hairs on each side, of the mesothorax with two, of the metathorax with two, and of abdominal segment I with one hair; the pronotum in the medial area with 6-7 hairs, 40-46  $\mu$  long, the mesonotum with 10-13 hairs, 30-50  $\mu$  long, the metanotum with 5-8 hairs, 29-50  $\mu$  long, abdominal segment I with 3-5 hairs 33-45  $\mu$  long, II with 0-2 hairs, III with 0-1 hairs, IV-VI without medial hairs, and VII sometimes with one hair, all these hairs thin and slender; the thickened lateral and posterior margin of segments II-VII about 16  $\mu$  wide, the crest 20  $\mu$  wide, radially striped due to small ridges; the dorsum of II with circular pustules, the surfaces of III-VII almost smooth, showing only muscular plate internal structures; a row of six hairs on each side is observable medial to the lateral thickening, the hairs rather slender, 12-25  $\mu$  long. Siphunculi with a thickened darker brown pore 23-25  $\mu$  wide. Abdominal segment VIII free, a black plate, e.g. 305  $\mu$  wide, and 160  $\mu$  long, the sides and the posterior margin with a thickened ridge, about 25  $\mu$  wide, and with a radially striped brown crest, about 20  $\mu$  wide, the plate with transversely arranged thickened imbrications, and in seven out of 13 specimens with two spinal hairs 45-52  $\mu$  long. The dorsal plate is connected on the lateral sides to the black, almost perpendicular sides, and this connection is frequently crushed in the slides; these sides densely covered with pustules, 12-20  $\mu$  wide at the base, and 6-10  $\mu$  high, no hairs observable. Legs brown, inserted about 500  $\mu$  below the dorsum. Length of the femur of the fore leg 129  $\mu$ , of the tibia 124  $\mu$ , the tibia 0.21-0.23 times as long as the distance between the outer margins of the eyes. On each side, about 250  $\mu$  below the dorsum, are two spiracles, one between the fore- and midleg, the other between mid- and hind leg. Cauda (fig. 330) 94-106  $\mu$  wide, with about 18 hairs, about 50  $\mu$  long. Subanal plate brown, strongly bilobed, but other characteristics, also of subgenital plate and gonapophyses, obscured by the dark colour of covering parts. The venter is an elliptical flat plate 1325-1500  $\mu$  long, and 1.3-1.4 times as long as it is wide, with a black margin, e.g. 150  $\mu$  wide with an irregular pattern, and an almost colourless central area, rather smooth, with the rostrum and some furrows, and without hairs.

Alate viviparous female.

Macerated specimen.— (figs. 331-337; one specimen). Body length 2.24 mm, 2.0 times as long as it is wide.

Head.— (fig. 331). Head brown, dorsally smooth, width across the eyes 480  $\mu$ , with three pairs of hairs anterior to the paired ocelli and one row of four hairs posterior, 33-55  $\mu$  long, 0.07-0.11 times as long as the width of the head across the eyes; ventrally no hairs observable. Antennae with black rings, with five segments, 715  $\mu$  long, 0.32 times as long as the body, and 1.5 times the width of the head across the eyes; segment I brown with dorsally and ventrally irregular wrinkles, the longest hair 35  $\mu$ , II brown, with, especially on the ventral side, a network with some spinulae, length of hair 27  $\mu$ ; segment III-V (fig. 332) with ring-shaped secondary rhinaria, the rings are not closed on the dorsal side, with a space of 18-40  $\mu$ ; between the rhinaria are 3-6 concentric spinulose imbrications, dorsally and ventrally with interconnections; the rhinaria are 3-4  $\mu$  wide, but on segment V up to 10  $\mu$  wide and bifurcat-

ed. The primary rhinarium on segment IV is moulded with an annular rhinarium, but on segment V distally some circular structures of a primary rhinarium are observable; segment III with 15, IV with seven, and V with three annular rhinaria, besides the primary rhinarium; hairs on segments III-V lacking, but segment V with four apical setae, 14  $\mu$  long. Length of segment III, 297  $\mu$ , 1.7 times as long as IV, 2.2 times as long as V, and 0.98 times as long as IV plus V; segment IV, 170  $\mu$  long, 1.3 times as long as V, and V, 134  $\mu$  long, with the processus terminalis, the distance to the last circular rhinarium, 22  $\mu$ . The last rostral segment (fig. 333) 108  $\mu$  long, 0.70 times as long as the second tarsal segment of the hind leg, without accessory hairs; length of the stylets 380  $\mu$ . Eyes compound.

Thorax.— Prothorax at each margin with three hairs. Fore wing (figs. 334, 335) medial vein once branched, the cubitus at the base a short distance removed from the anal vein. Femora, tibiae and second tarsal segments with spinulose imbrications; the tibia of the fore leg 485  $\mu$  long, 1.02 times as long as the width of the head across the eyes, longest hairs of the hind tibia 65  $\mu$ ; chaetotaxy of first tarsal segments in the last larval stage presumably 3, 3, 2. Length of the hind segments: femur fused with the trochanter 535  $\mu$ , tibia 724  $\mu$ , 1.35 times as long as the femur, and 1.5 times the width of the head across the eyes; first tarsal segment 54  $\mu$  long, second tarsal segment 154  $\mu$ .

Abdomen.— (fig. 336). Abdominal segments I-VII each marginally with a brown plate with spinulose imbrications, and those of segments IV-VII also with darker brown warts, and the plate in the middle about 30  $\mu$  raised, diameter of plate I about 40  $\mu$ , of the other plates about 90  $\mu$ ; each plate with one hair, 70-90  $\mu$  long. Tergites I and II colourless, III-VI each with two slightly transversely elongate, pale brown spots, 70-90  $\mu$  wide, VI only with some spinulose imbrications, and all lacking hairs; tergite VII with one pale brown spot in the middle, 40  $\mu$  long and 150  $\mu$  wide with spinulose imbrications, and one hair, 70  $\mu$  long; tergite VIII pale brown, broadly rounded, with spinulose imbrications and some ridges in the spinal area, with seven hairs, the spinal hairs 100  $\mu$  long. Siphunculi pale brown, on segment VI, medial to, and joined with the marginal plate, with some spinulose imbrications and some concentric wrinkles, extending 10-18  $\mu$  around the pore; the pore brown, about 15  $\mu$  raised, with a diameter of 45  $\mu$ , without hairs. Number of hairs ventrally on presumably segment I, 11; II four; III nine; IV, 43, 58  $\mu$  long; V, 23; and VI (the last segment anterior to the genital plate) 22. Cauda (fig. 337) transversely elongate, 137  $\mu$  wide, and 43  $\mu$  long, with 12 hairs, the longest 100  $\mu$ . Subanal plate strongly bilobed, with 17 hairs, the longest 92  $\mu$ . Subgenital plate with 19 anterior hairs, spread on the plate, the longest 63  $\mu$ , and 18 hairs along the posterior margin, the longest 82  $\mu$ . Gonapophyses two, each with 9-12 hairs, 20-23  $\mu$  long. Spiracles on five abdominal segments, I-V.

Embryo inside apterous viviparous female (figs. 338-340).

Macerated specimens.— Body length 490-560  $\mu$ , 1.8 times as long as it is wide, head fused with the prothorax; mesothorax, metathorax and abdominal segments I-VII presumably fused, and segment VIII free. Length of head plus pronotum 193  $\mu$ , width of prothorax 259  $\mu$ ; head across the eyes 196  $\mu$  (distance between the outer margins of the eyes measured across the dorsal side 230  $\mu$ ), with dorsally two frontal hairs, and four hairs in a row between the eyes, 65  $\mu$  long, or even 100  $\mu$ . Medial to the eyes, a somewhat spread-out group of 12-16 oval wax glands, the glands with a

diameter of 10-15  $\mu$ . Antennae with three segments, 223  $\mu$  long, segment III, 161  $\mu$  long, with imbrications with sometimes indistinct spinulae, the distal rhinarium 22  $\mu$  from the tip, the other 77  $\mu$ ; length of hair on segment I, 40  $\mu$ ; on II, 65  $\mu$ ; on III hairs are lacking, but the apical setae 50-105  $\mu$  long. Eyes with three ommatidia. Last rostral segment 67  $\mu$  long, stylets 440-490  $\mu$  long. Prothorax on each side with two hairs, and the pronotum with two hairs, 85  $\mu$  long, a marginal group of 7-12 wax glands, and two spinal groups of 15-16 glands. The mesothorax with on each side two hairs, and two spinal hairs; 8-9 glands in each marginal group, and two spinal groups each with 10-11 glands. Metathorax on each side two hairs, and two spinal hairs, the marginal wax gland groups with six glands, the two spinal groups each with 9-11. Tibiae with imbrications, the fore tibia 108  $\mu$  long, the hind tibia with hairs 55  $\mu$  long, and distally with two spines, 10-12  $\mu$  long. All first tarsal segments with two hairs, 50-55  $\mu$  long. Second tarsal segment (fig. 339) of the hind leg with four apical hairs with expanded tips, the two dorsal hairs more sturdy, 55  $\mu$  long; empodial hair 23  $\mu$  long. Abdominal segments I-VII each with one marginal hair, 14-30  $\mu$  long, tergite I with two spinal hairs 28-100  $\mu$  long, tergites II-VII without spinal hairs; segments I-III with 4-7 marginal wax glands, and with two groups of 4-6 spinal glands; IV with 3-4 marginal and two groups with two spinal glands; V, 3-4 marginal, and two groups with 0-1 spinal glands; VI, 1-4 marginal glands, and two groups with 0-1 spinal glands; VII, 1-3 marginal glands, spinal glands are lacking; segments III-VII (fig. 340) ventral to the marginal hairs and wax glands dotted, observable at a magnification of 400; segment VIII dotted, with two spinal hairs, 58-75  $\mu$  long, and without wax glands. Siphunculi are lacking.

Last stage larva of alate viviparous female (figs. 341, 342), the only larva present, differs markedly from embryos of apterous viviparous females: The whole body is covered with a pattern of figures with an irregular outline, 15-30  $\mu$  diameter, and about 10  $\mu$  high, but on head and thorax also small pustules. Groups of oval wax glands are lacking, but at their location, in the larva are pairs of spinal tubercles on head, thorax and abdominal segments I-V, about 20  $\mu$  high, and marginal tubercles on abdominal segments I-VII, 40-50  $\mu$  high. The siphunculi are on abdominal segment VI.

Embryo from alate viviparous female (fig. 343).

Macerated specimens.— Body pale brown, 715  $\mu$  long, 1.4 times as long as it is wide, head marginally fused with all thoracic segments and abdominal segments I-VII, dorsally a distinct separation between pro- and mesonotum and furrows between mesonotum and metanotum and between abdominal segments I-VII; segment VIII free. Length of head plus pronotum 280  $\mu$ , width of prothorax 465  $\mu$ ; head across the eyes 303  $\mu$  (distance between the outer margins of the eyes measured across the dorsal side 330  $\mu$ ) with dorsally two pairs of frontal hairs, and four hairs in a row between the eyes, 25-45  $\mu$  long; wax glands lacking. Antennae with three segments, 181  $\mu$  long, segment III with imbrications, the distal rhinarium 16  $\mu$  from the tip, the other 55  $\mu$ ; length of hair on segment I, 39  $\mu$ , on II, 15  $\mu$ , on III hairs are lacking, but the four apical setae 20  $\mu$  long. Eyes with three ommatidia. Stylets 240  $\mu$  long. Prothorax on each side with two hairs, and the pronotum with two hairs, about 30  $\mu$  long; marginally a ring, and dorsally a pair of rings with a diameter of 14  $\mu$ ; ventrally at the margins a spiraculum.

Meso- and metathorax each with two marginal hairs, and a pair of hairs on the



dorsum 25-33  $\mu$  long, wax glands are lacking. The hind tibiae with hairs up to 33  $\mu$  long, and distally with two spines, 8-12  $\mu$  long. All first tarsal segments with two hairs, about 42  $\mu$  long. Second tarsal segment of the hind leg with four apical hairs with expanded tips, the two dorsal hairs more sturdy, 55  $\mu$  long; empodial hair 25  $\mu$  long. Abdominal segments I-VII each with one marginal hair, 22-27  $\mu$  long, tergite I with a pair of hairs, 20-27  $\mu$  long, tergites II-VII without spinal hairs; wax glands are lacking. Siphunculi on segment VI, the pore with a diameter of 18  $\mu$ . Segment VIII with two spinal hairs, 40  $\mu$  long.

Host plant records.— Specimens were collected in Java from "wranak" the javanese name for *Lithocarpus sundaicus* (Bl.) Rehd., Pekasirie, 14.viii.1919, leg. P. van der Goot, in the collection at the Laboratorium voor Entomologie, Wageningen.

Alatae were collected 14.viii.1919.

Etymology.— Vandergooti, name given to commemorate Dr. P. van der Goot, who collected this aphid.

#### Genus *Neohormaphis* gen. nov.

(figs. 344 - 359)

Type species *Neohormaphis calva* spec nov.

Description.— I. Morphs from *Distylium stellare* O.K., leaf galls (one species).

Apterous viviparous female.— Presumably fundatrix. In life greyish, without wax powder.

Macerated specimens.— Body colourless 0.85-0.90 mm long, 1.8 times as long as it is wide. The head fused with the prothorax only, without horns and ventral spines. Antennae 130-140  $\mu$  long, about 0.15 times as long as the body, with three segments. Eyes with three ommatidia. Last rostral segment without accessory hairs, 53-55  $\mu$  long, 1.36-1.45 times as long as the second tarsal segment of the hind leg; stylets 164-176  $\mu$  long. Tibia of the fore leg 106-116  $\mu$  long. Hairs of first tarsal segments not observable. Second tarsal segment of the hind leg dorsoapical hairs without expanded tips. The dorsum according to Van der Goot (unpublished) bare, the abdominal segments in all presumably with four hairs, up to 55  $\mu$  long. Siphunculi are lacking. Cauda with four hairs, 22-25  $\mu$  long. Subanal plate with six hairs, 28-31  $\mu$  long. Subgenital plate with two anterior, and 6-8 posterior hairs.

Alate viviparous female.— In life: Head and thorax black, abdomen dark grey.

Macerated specimens.— Body length 1.4-1.8 mm. The head smooth, without horns or dagger hairs, with anteriorly 6-8 hairs, sometimes in three pairs, and a posterior row of four hairs, 16-22  $\mu$  long, 0.04-0.06 times as long as the width of the head across the eyes. Antennae with five segments, 580-605  $\mu$  long, about 0.34-0.40 times as long as the body, and 1.5-1.6 times the width of the head across the eyes, the process terminalis 4-14  $\mu$  long. Antennal segments III-V with ring-shaped secondary rhinaria; between the rhinaria 4-5 concentric spinulose imbrications; the primary rhinaria on segments IV and V extend over a length of 30-60  $\mu$ , and are moulded together with 5-8 annular rhinaria; segment III with 16-21 annular rhinaria, IV with 11-15, and V with 8-11. The last rostral segment 63-65  $\mu$  long, 0.72-0.81 times as long as the second tarsal segment of the hind leg, without accessory hairs; length of the stylets

190-215  $\mu$ . Eyes compound. The medial vein of the fore wing is unbranched, and branching from cubital vein II, and this once again from cubitus I. Femora, tibiae and second tarsal segments with spinulose imbrications; tibia of the fore leg 342-375  $\mu$  long, 0.86-0.99 times as long as the width of the head across the eyes; first tarsal segments of all legs with three hairs; two dorsoapical hairs of the second tarsal segment of the hind leg with expanded tips, the hairs 50-53  $\mu$  long, the tips about three  $\mu$  wide; the empodial hair of the hind leg 24  $\mu$  long. Abdomen colourless, marginally each segment presumably with one hair, 18-23  $\mu$  long, on tergites I-VII all together 2-3 hairs, 14-17  $\mu$  long. Tergite VIII with 5-6 hairs, 18-27  $\mu$  long. Siphunculi presumably on segment VI, without hairs. Brown spiracles on segments II, III, IV and V. Cauda hardly developed, transversely elongate, 96-102  $\mu$  wide and 25  $\mu$  long, with 4-6 hairs, the longest 18-23  $\mu$ . Subanal plate with a deep longitudinal furrow, but not distinctly bilobed, with 10 hairs, 20-27  $\mu$  long. Subgenital plate with 4-8 anterior, and 10-14 posterior hairs. Gonapophyses two, each with 5-7 hairs, 12-16  $\mu$  long.

Embryos inside alatae with marginal and spinal hairs which usually have rounded tips, about 18-22  $\mu$  long, and up to 5  $\mu$  wide in the basal half; close to each hair is a button organ with a diameter of about 10  $\mu$ .

## II. Morphs from *Quercus*.

Apterous viviparous female.— Macerated specimens. Body light to very dark brown a flat oval dorsum with a straight frons, 765-1026  $\mu$  long, 1.3-1.5 times as long as it is wide. The prosoma, the fused head, thorax and abdominal tergites I-VII overlap the ventral side completely; the dorsum with pustules arranged in lumps, interrupted by sunken intermuscular plates and a transverse furrow in the middle between pro- and mesonotum; the margin of the prosoma smooth and without interruptions. The head without horns and dagger hairs, between the eyes an anterior row of four hairs, but posterior to the eyes hairs are lacking. Antennae with three segments, 98-137  $\mu$  long, 0.10-0.15 times as long as the body, and 0.33-0.49 times the distance between the outer margins of the eyes. The eyes with three ommatidia. Ultimate rostral segment 0.72-0.83 times as long as the second tarsal segment of the hind leg; length of the stylets 160-180  $\mu$ . Margin of the dorsum behind the eyes on each side with 13 hairs, and a pair of dorsal hairs on the thoracic segments and abdominal segments I and II; the hairs have a typical spindle shape, with rounded tips, 30-45  $\mu$  long and 4-6  $\mu$  wide near the base. Siphunculi presumably located on segment V, a thickened pore, 20-27  $\mu$  wide. Abdominal segment VIII free, a plate with four hairs, 42-49  $\mu$  long and 6-8  $\mu$  wide near the base. The venter is a colourless flat plate without hairs. Spiracles: one between fore- and midleg, the other between mid- and hind leg.

The cauda a knob 49-60  $\mu$  wide, with eight hairs, the longest 43-53  $\mu$ . Subanal plate with 11-12 hairs. Subgenital plate with two anterior and 6-7 posterior hairs.

Alate viviparous female.— Differing from alatae from galls of *Distylium*: Length of hairs dorsally on the head 12-18  $\mu$ . Antennal segment III, 2.3-3.0 times as long as V. First tarsal segment of the hind leg with three hairs. The cauda with a knob, with 7-8 hairs, 22-37  $\mu$  long. Subanal plate with 15-16 hairs. Subgenital plate with two anterior and 7-9 posterior hairs. Embryos in the alatae with thin hairs, and button organs lacking.

Etymology.— *Neohormaphis*, new *Hormaphis*, name which Van der Goot (unpublished) intended to use for the genus of the species *N. calva*.

***Neohormaphis calva* spec.nov.**  
(figs. 344-359)

Types.— Holotype (alate viviparous female) from leaf gall of *Distylium stellare* O.K., leaf gall, Sindoro (1500 m), Java, Indonesia, 2.ix.1916, leg. P. v.d. Goot, Det. P. v. d. Goot: *Hormaphis*, no. 177-2-1, and with separate antennal segments III.-V-2. Paratypes about 15 fragmentary alate viviparous females, and four apterous viviparous females nos. 177-1 to 177-4 with same data as holotype, and no. 236 *Distylium stellare* O.K. (pitjisan), leaf gall, Merbaboe (1500 m), 5.vi.1916, leg. P. v.d. Goot, Det. P. v.d. Goot: *Hormaphoides*. Holotype and paratypes in the collection at the Laboratorium voor Entomologie, Wageningen.

Van der Goot collected this aphid, and described the apterous viviparous females and alate viviparous females from galls on leaves of *Distylium stellare* O.K. Apart from these aphids, Van der Goot collected aphids from *Quercus*, which he did not describe, and the only data available are on the labels of the mounts; these aphids have very characteristic marginal and dorsal hairs, with acute tips, and widened gradually towards the base, next to these hairs are single circular organs (button organs). The embryos inside the alatae from the galls show these typical hairs and circular organs, which led me to conclude that the aphids of *Distylium* and *Quercus* both belong to this species. The material from *Distylium* is fragmentary, but nevertheless showing sufficient characteristics for the description presented here, which also contains many data from Van der Goot's manuscript.

I. Material from galls of *Distylium stellare*.

Apterous viviparous female.— Presumably fundatrix. In life: Body greyish, with a violet tinge, without any wax powder. Eyes black. Antennae greyish. Legs grey, tarsi black.

Macerated specimens.— (fig. 344; described from four specimens, bleached or corroded). Body colourless, ovate, somewhat arched, 0.85-0.90 mm long, 1.8 times as long as it is wide. The head with some hairs, 38-50  $\mu$  long. Antennae very pale brown, 130-140  $\mu$  long, about 0.15 times as long as the body, with three segments; segment I, 25-28  $\mu$  long, with a hair 16-22  $\mu$  long, segment II, 20-25  $\mu$  long with a hair, 22-30  $\mu$  long; segment III, 86-98  $\mu$  long, the basal part about 32  $\mu$  wide, the part distal to the penultimate rhinarium 18  $\mu$  wide; the last rhinarium 4-6  $\mu$  removed from the tip, the other 20-47  $\mu$ ; without hairs, but apically with four setae, 12-14  $\mu$  long. Eyes pale brown, with three ommatidia, 10-12  $\mu$  diameter. Ultimate rostral segment 53-55  $\mu$  long, 1.36-1.45 times as long as the second tarsal segment of the hind leg; stylets 164-176  $\mu$  long. Legs very pale brown, the tarsi slightly darker. Tibia of the fore leg 106-116  $\mu$  long. Hairs of first tarsal segments not observable; second tarsal segment of the hind leg 0.22-0.24 times as long as the tibia of the hind leg, dorsoapically with one or two hairs, not expanded at the tips, 22  $\mu$  long. Length of segments of the hind leg: femur with trochanter 159-166  $\mu$ , tibia 169-176  $\mu$ , 1.02-1.06 times as long as the femur, the longest distal hair about 22  $\mu$  long, and with two distal setae, up to 12  $\mu$  long, first tarsal segment 18  $\mu$ , second tarsal segment 38-40  $\mu$ . On the posterior part of the abdomen, dots with a diameter of about 0.5  $\mu$ , close together, but no more details observable. Abdominal segment VIII presumably with four hairs, up to 55  $\mu$  long. Siphunculi are lacking. Cauda with 4-6 hairs, 22-25  $\mu$  long. Subanal plate with six hairs, 28-31  $\mu$  long. Subgenital plate with two anterior hairs, 37  $\mu$  long, and 6-8 poste-

rior hairs, 29–45  $\mu$  long.

**Alate viviparous female.**— In life: Head and thorax black, abdomen dark grey. Eyes, antennae and legs black. Siphunculi with dark rims. Pterostigma of fore wings black.

**Macerated specimens.**— (figs. 345–351; six fragmentary specimens). Body length 1.44–1.77 mm, 1.9–2.5 times as long as it is wide.

**Head.**— (fig. 345). Head brown, dorsally smooth, width across the eyes 362–410  $\mu$ , with in the area dorsal to the median ocellus up to between the paired ocelli 6–8 hairs, sometimes distinctly in three pairs, 16–22  $\mu$  long, 0.04–0.06 times as long as the width of the head across the eyes; posterior to the paired ocelli one row of four hairs; the head ventral to each side 2–5 hairs about 8–14  $\mu$  long. Antennae with black rings, with five segments, 580–605  $\mu$  long, about 0.34–0.40 times as long as the body, and 1.5–1.6 times the width of the head across the eyes; segment I with imbrications, sometimes with spinulae of not more than one  $\mu$ , ventrally in a network pattern, with a hair 16–20  $\mu$  long; segment II with imbrications in a network pattern, and everywhere with spinulae as dots of not more than one  $\mu$ , with a hair 16–20  $\mu$  long; segments III–V (fig. 346) with ring-shaped secondary rhinaria, the rings are not usually closed on the dorsal side, with a space of 0–20  $\mu$ ; between the rhinaria are 4–5 concentric spinulose imbrications, dorsally and ventrally with interconnections; the rhinaria are 2–3  $\mu$  wide; the primary rhinaria on segments IV and V extend over a length of 30–60  $\mu$ , and are moulded together with 5–8 annular rhinaria; segment III with 16–21 annular rhinaria, IV with 11–15, and V with 8–11; hairs on segments III–V usually lacking, but segment V with four apical setae, 10–14  $\mu$  long. Length of segment III, 220–248, 1.6–1.9 times as long as IV, 1.8–2.0 times V, and 0.85–0.97 times IV plus V; segment IV, 127–149  $\mu$  long, 1.0–1.2 times as long as V, and V, 118–128  $\mu$  long, with the distance from the tip to the last circular rhinarium, 4–14  $\mu$ . The last rostral segment (fig. 347) 63–65  $\mu$  long, 0.72–0.81 times as long as the second tarsal segment of the hind leg, without accessory hairs; length of the stylets 190–215  $\mu$  long. Eyes compound.

**Thorax.**— Prothorax at each margin with two hairs. Fore wing (fig. 348) medial vein unbranched, and branching from cubital vein, and this once again from the anal vein; the hind wing with only one longitudinal vein, transverse veins not present. Legs almost evenly brown; the femora with not very distinct spinulose imbrications, the tibiae densely with imbrications with spinulae, 1–3  $\mu$  long; tibia of the fore leg (fig. 349) 342–375  $\mu$  long, 0.86–0.99 times as long as the width of the head across the eyes, longest hairs of the hind tibia 18–22  $\mu$ ; chaetotaxy of first tarsal segments 3, 3, 3, the lateral hairs 3–4 times as long as the middle hair; length of lateral hairs of the first tarsal segment of the hind leg (fig. 350) 35–45  $\mu$ ; two dorsoapical hairs of the second tarsal segment of the hind leg with expanded tips, 50–53  $\mu$  long, the tips about three  $\mu$  wide; length of the empodial hair of the hind leg 12–23  $\mu$ . Length of the hind segments: femur fused with trochanter 310–367  $\mu$ , tibia 464–511  $\mu$ , 1.33–1.39 times as long as the femur, and 1.2 times the width of the head across the eyes: first tarsal segment 31–35  $\mu$  long, second tarsal segment 80–88  $\mu$ .

**Abdomen.**— Abdomen colourless, marginally each segment presumably with one hair, 18–23  $\mu$  long, dorsally altogether two or three hairs observable on segments I–VII, 14–17  $\mu$  long; segment VIII presumably with 5–6 hairs, 18–27  $\mu$  long. Siphunculi presumably on segment VI, the pore partly pale brown, 20–23  $\mu$  diameter. Cauda (fig.

351) hardly developed, broadly rounded, about 100  $\mu$  wide and 25  $\mu$  long, with 4-6 hairs, 18-23  $\mu$  long. Subanal plate with a deep longitudinal furrow, but not distinctly bilobed, with 10 hairs, 20-27  $\mu$  long. Subgenital plate with 4-8 anterior hairs, 22-25  $\mu$  long, and 10-14 posterior hairs, 27-31  $\mu$  long. Gonapophyses two, each with 5-7 hairs, 12-16  $\mu$  long. Spiracles on four abdominal segments, II-V.

Embryos inside alatae (figs. 352-353) with marginal and spinal hairs which frequently have rounded tips and are much wider near the base than normal hairs, about 18-22  $\mu$  long and up to 5  $\mu$  wide in the basal half; close to each hair is a button organ with a diameter of about 10  $\mu$ , for a description of button organs see larva of alata of morphs on *Quercus*.

## II. Material from *Quercus*.

Apterous viviparous female.— In life: Unknown, but from the name "pulverulens", which Van der Goot intended to give to this species it can be concluded that the specimens from *Quercus* were covered with wax powder.

Macerated specimens.— (figs. 354-356; described from 17 specimens). Body light to very dark brown, with a rather flat oval dorsum with a straight frons, 765-1026  $\mu$  long, 1.3-1.5 times as long as it is wide; the dorsum overlaps the margins and the ventral side completely. The prosoma consists of head, thorax and abdominal segments I-VII, dorsally fused; the margin without any segmental interruption, smooth, flat with only a few dots, two  $\mu$  wide, which increase in size and number towards the centre of the dorsum and change to pustules, 10-15  $\mu$  wide; the pustules are arranged in lumps which are bordered by muscle plates sunk about 20  $\mu$ ; a distinct transverse furrow is present between the muscle plates between pro- and mesonotum, other transverse furrows are rather indistinct. The prosoma is 6.3-8.2 times as long as the free abdominal segment VIII. The head dorsal to the antennae with two pairs of hairs (figs. 354, 355) usually protruding, 37-45  $\mu$  long; dorsally between the eyes a row of four hairs, 37-45  $\mu$  long, near the base 4-6  $\mu$  wide; posterior to the eyes hairs are lacking. Eyes located dorsally at the margin, with three ommatidia with a diameter of 10  $\mu$ , distance between the outer margins of the eyes 236-295  $\mu$ . Antennae the same colour as the body, located under the dorsum, 98-137  $\mu$  long, 0.10-0.15 times as long as the body, and 0.33-0.49 times the distance between the outer margins of the eyes; segment I basally fused with the head, distance between the bases 80-120  $\mu$ ; segment I about 20  $\mu$  long with a sideways bend, with a hair 6-10  $\mu$  long; segment II about 25-30  $\mu$  long, with a hair 4-8  $\mu$  long; segment III, 61-90  $\mu$  long, smooth, without hairs but with some apical setae, the processus terminalis 2-6  $\mu$  long, the penultimate rhinarium 18-27  $\mu$  from the tip. Ultimate rostral segment in two specimens, 43-49  $\mu$  long, 0.72-0.83 times as long as the second tarsal segment of the hind leg; length of the stylets 160-180  $\mu$ . Muscular plates on the head and other parts of the dorsum without distinct facets.

The pro-, meso- and metanotum each on each side with two marginal hairs, and two dorsal hairs, each in the centre of a lump. Abdominal segments I and II each with one marginal hair and one pair of dorsal hairs. Abdominal segments III-VII marginally and pleurally with dots and pustules as on anterior segments, but in the middle area transverse spinulose imbrications and ridges are present; a marginal hair corresponding to each of segments III-VII is present, 30-43  $\mu$  long, but on segment IV, 16-30  $\mu$  long, on V, 12-23  $\mu$ ; pleural and medial hairs are lacking. The posterior margin of VII is straight in the middle or has a submedian bent backwards, the

margins protrude backwards with respect to the middle 50-60  $\mu$  with a rounded process. Siphunculi presumably located on segment V, with a thickened darker brown pore, 20-27  $\mu$  wide. Abdominal segment VIII free, e.g. 196  $\mu$  wide, and 108  $\mu$  long with a straight anterior margin, and posteriorly rounded, with a thickened posterior margin, with pustules 5-8  $\mu$  wide and anteriorly transverse ridges; posteriorly on the ventral side a crest is present, protruding somewhat at the sides; dorsally four hairs (fig. 356), 42-49  $\mu$  long and 6-8  $\mu$  wide near the base. The margins of the prosoma curve downwards to the ventral plate and are provided, especially near the coxae and spiraculi, with pustules; ventral to abdominal segment VIII the ventral side gradually slopes down over a distance of one quarter the length of the body, is brown and provided with spinulose imbrications; the venter is flat, colourless and without hairs. Legs paler brown than the body, tibia of the fore leg 94-106  $\mu$  long, 0.32-0.41 times as long as the distance between the outer margins of the eyes. First tarsal segments of the fore- and midleg with three hairs, of the hind leg with two, 10-15  $\mu$  long. Length of the hind segments: femur fused with the trochanter 141-165  $\mu$ , tibia 165-204  $\mu$ , 1.15-1.30 times as long as the femur, and 0.56-0.73 times the distance between the outer margins of the eyes; first tarsal segment 23-27  $\mu$  long, second tarsal segment 49-61  $\mu$ . Spiracles: one between fore- and midleg, the other between mid- and hind leg, and lacking on the abdomen. Cauda pale brown, a knob with a constriction, e.g. 54  $\mu$  wide, 31  $\mu$  long, and diameter of the constriction about 40  $\mu$ ; the knob 49-60  $\mu$  wide, with eight hairs, the longest 43-53  $\mu$ . Subanal plate pale brown, bilobed, with 11-12 hairs, 80-94  $\mu$  long. Subgenital plate with two anterior hairs, 15-20  $\mu$  long, and 6-7 posterior hairs, 29-37  $\mu$  long. Gonapophyses two, in the specimen in which observable, each with 1-2 hairs, eight  $\mu$  long.

Alate viviparous female.

Macerated specimens.— (fig. 357; described from four specimens). Body length 1.40-1.58 mm, 2.0-2.3 times as long as it is wide.

Head.— Head brown, dorsally smooth, width across the eyes 342-391  $\mu$ , with dorsal to the median ocellus up to between the paired ocelli six hairs, sometimes distinctly in three pairs, 12-18  $\mu$  long; posterior to the paired ocelli one row of four hairs; the head ventrally with six hairs, 12-14  $\mu$  long. Antennae with brown rings, with five segments, 531-630  $\mu$  long, 0.35-0.43 times as long as the body, and 1.4-1.6 times the width of the head across the eyes; segment I with spinulose imbrications somewhat as a network, with a hair 10-12  $\mu$  long; segment II with an irregular network, length of hair 10-12  $\mu$ ; segments III-V with ring-shaped secondary rhinaria, the rings are not closed on the dorsal side, with a space of 0-20  $\mu$ ; between the rhinaria are 3-6 concentric spinulose imbrications, dorsally and ventrally with interconnections; the rhinaria are 2-3  $\mu$  wide; the primary rhinaria on segments IV and V extend over a length of 12-30  $\mu$ , and are moulded together with 2-3 annular rhinaria; segment III with 19-26 annular rhinaria, IV with 7-12, and V with 7-10; hairs on segments III-V are lacking, but segment V with three apical setae, 12  $\mu$  long. Length of segment III, 236-314  $\mu$ , 2.1-2.4 times as long as IV, 2.3-3.0 times V, and 1.03-1.31 times IV plus V; segment IV, 118-133  $\mu$  long, 1.2 times as long as V; and V, 96-106  $\mu$  long, with the distance from the last circular rhinarium to the tip 2-14  $\mu$ . The last rostral segment 51-55  $\mu$  long, 0.68-0.74 times as long as the second tarsal segment of the hind leg, without accessory hairs; length of the stylets 186-205  $\mu$  long. Eyes compound.

Thorax.— Prothorax on each side sometimes two hairs. Fore wing medial vein

unbranched, branching from the cubital vein, and this again from the anal vein; the hind wing with only one longitudinal vein, transverse veins not present. Legs evenly brown; the femora smooth, the tibiae densely with spinulose imbrications; tibia of the fore leg 301-314  $\mu$  long, 0.78-0.88 times as long as the width of the head across the eyes, longest hairs of the hind tibia 16-20  $\mu$ ; chaetotaxy of the first tarsal segments 3, 3, 2, the lateral hairs 2.7-3.1 times as long as the middle hair; length of the hairs of the first tarsal segment of the hind leg 35-39  $\mu$ ; two dorsoapical hairs of the second tarsal segment of the hind leg with expanded tips, 43-50  $\mu$  long, the tips 2-4  $\mu$  wide; length of the empodial hair of the hind leg 23-27  $\mu$ . Length of the hind segments: femur fused with trochanter 287-314  $\mu$ , tibia 425-456  $\mu$ , 1.45-1.51 times as long as the femur, and 1.17-1.24 times the width of the head across the eyes; first tarsal segment 27-30  $\mu$  long, second tarsal segment 74-78  $\mu$ .

Abdomen.— Abdomen colourless, marginally each segment presumably with one hair, dorsally on segments I and II sometimes a pair of thin hairs observable, but on tergites III-VII hairs are lacking; tergite VIII with four hairs in the middle area, 20-23  $\mu$  long. Siphunculi on segment V, a pale brown ring only, 21-23  $\mu$  diameter. Cauda (fig. 357) at the base e.g. 98  $\mu$  wide, with a knob 49  $\mu$  wide and 18  $\mu$  long, and only slightly constricted; the knob 43-49  $\mu$  wide, with 7-8 hairs, the longest 22-37  $\mu$  long. Subanal plate bilobed with 15-16 hairs, the longest 27-30  $\mu$ . Subgenital plate with two anterior hairs, 16-23  $\mu$  long, and 7-9 posterior hairs, scattered over the plate, 29-33  $\mu$  long. Gonapophyses two, each with 6-7 hairs, 12-16  $\mu$  long. Spiracles on two abdominal segments, presumably II and III.

First stage larvae of apterous viviparous females are lacking, but embryos inside apterous viviparous female have antennae 112-125  $\mu$  long, hairs on the body 19-22  $\mu$  long and two  $\mu$  wide near the base, with a sharp point, button organs with a diameter of 8-10  $\mu$ , presumably arranged as described here for the last stage larva of alatae. If the same is as true as is found in *Reticulaphis distylii*, embryos with button organs grow into alate viviparous females.

Last stage larva of alate viviparous female (figs. 358, 359), description of one specimen: Body length 1.10 mm, width of the head across the eyes 346  $\mu$ . Anterior to the eyes two pairs of hairs, and posterior to these one row of four hairs, the hairs normal, 45-50  $\mu$  long, ending in a fine point; lateral to the middle hairs of the four is a button organ (Hille Ris Lambers and Takahashi, 1959: 14); the button organ (fig. 359) consists of a cylinder with a diameter of usually 16  $\mu$ , five  $\mu$  high with a yellowish sclerotic wall, seen from above two  $\mu$  thick, a convex disc covers this cylinder, being sunk into it about one  $\mu$ ; the border of the disc being connected by a membrane to the upper border of the cylinder; the disc has dots like a wax gland; the button organ is located on an oval area, 25-35  $\mu$ , mainly recognizable by a fine contour line. Posterior to the eyes a pair of button organs, but hairs are lacking. The prothorax on each side two hairs with 2-3 button organs, and dorsally two hairs and two button organs. The mesothorax marginally with two hairs and one button organ on each side, dorsally with 4-5 hairs and two button organs. The metathorax as the mesothorax but with two dorsal hairs. Abdominal segments I and II marginally with one marginal hair and one button organ, and dorsally two hairs and two button organs. Abdominal segments I-VII each with one marginal hair and one button organ on segments VI and VII, and dorsally hairs and button organs are lacking; abdominal tergite VIII with four hairs, 45-50  $\mu$  long. Siphunculi on segment V, the pore 22  $\mu$

diameter.

Host plant records.— Specimens were collected in Java from *Distylium stellare*, leaf gall, Merbaboe (1500 m.), 5.vi.1916, and dessa Sabadjak, Mt. Sindoro (1500 m), 2. ix.1916, leg. P. van der Goot, in the collection at the Laboratorium voor Entomologie, Wageningen; and from *Quercus spec.*, Bogor, 10.viii.1916, and 19.x.1919, legit P. v. d. Goot, in the collection at the British Museum (Natural History), London.

The aphids live in galls on the upperside of the leaves, not unlike those on the same tree caused by *Reticulaphis distylii* (Van der Goot). The galls are semi-globose, somewhat woolly-pilose, on the underside of the leaf not, or scarcely, protruding. Mature galls measure about 1.5 cm diameter; they have a pale greenish colour, sometimes with a brownish tinge due to the pilosity on the gall. The galls may be found on all parts of the upper surface of the leaf; they often rise from the midrib or from the smaller veins. Usually, one leaf bears only one gall, in some cases, however, three or four galls were found on the same leaf. The galls collected on the western slope of Mt. Merbaboe towards the end of May 1916 contained only one single fundatrix at the bottom of the inner gall room. Towards the beginning of September 1916, galls were collected from small forests at the base of Mt. Sindoro, but most were already empty; some galls, still closed, were filled with nymphs and numerous alate females, ready to leave the gall, escaping through a small hole on the underside of the leaf. Nothing is known on the life on *Quercus*.

Alatae were collected from *Distylium stellare* 5.vi.1916, and from *Quercus spec.* 10.viii.1916.

Etymology.— Calva, bald, hairless; this name which Van der Goot intended to use for this species is upheld and refers to the "bare dorsum" of apterous and alate viviparous females.

### Genus *Nipponaphis* Pergande, 1906 (figs. 360-384)

*Nipponaphis* Pergande, 1906: 205 (type species *Nipponaphis distychii* Pergande, 1906).

Description.— Apterous viviparous females.— (five species). In life: Brown and yellowish, dark purple or black, smooth or with distinct furrows and wrinkled. Covered by a smooth layer of transparent wax, with a thin layer of wax powder, or without wax.

Macerated specimens.— Body pale brown, brown or black, rather flat and smooth, or with segmental vaults and intersegmental furrows, with three parts separated from each other by membranes or sclerotic sutures: (1) prosoma, the fused head, thorax and abdominal tergite I, the medial part of meso- and metanotum not sunk, margin of the prosoma without stripes, usually with pustules, but sometimes almost smooth; (2) the complex of tergites II-VII, the lateral margins well-defined, and enclosed by the sides of the prosoma, spinally sometimes fused with tergite I, the segmental borders observable as sutures or sutures are lacking, the sides and posterior margin with or without a crest; (3) tergite VIII free, with or without a crest. The prosoma is 2.3-6.9 times as long as complex II-VII, and 7-17 times as long as tergite VIII. Length of the body 975-1800  $\mu$ , 1.0-1.5 times as long as it is wide. The head



without horns or dagger hairs, and as other parts of the body without wax gland groups; anterior to the eyes and dorsal to the antennae a bend inwards, or this bend is lacking; in *N. javanica* and *N. multisetosa* two hairs on each side mark the pro-, meso- and metanotum, and one hair on each side abdominal segment I; in *N. multisetosa* and *N. semiglabra* two pairs of four intersegmental muscular plates and some transverse furrows are useful in locating these four segments of the prosoma; the prosoma is densely covered with pustules 8-30  $\mu$  wide and 6-15  $\mu$ , 4-10  $\mu$  or 2-6  $\mu$  high in *N. brevopilosa*, *N. ficicola*, *N. javanica* and *N. multisetosa*, but in *N. semiglabra* in many areas pustules are present as almost flat ovals. The head anteriorly with three pairs of hairs, and posterior to the eyes a transverse row of four hairs, but in *N. semiglabra* with more hairs, and in *N. multisetosa* with numerous; length of these hairs 55-110  $\mu$ , but in *N. brevopilosa* 14-23  $\mu$ . The pro-, meso-, metathorax and abdominal segment I with 2, 3, 3, 2 hairs respectively in *N. javanica*, but in the other species with more hairs, up to in *N. multisetosa* 15-50 on each segment. Antennae with three or four segments, bent sideways on segments I and II, 202-279  $\mu$  long, 0.13-0.22 times as long as the body, and 0.47-0.72 times the distance between the outer margins of the eyes; the distal rhinarium located 0-20  $\mu$  from the tip, the other 51-78  $\mu$ . Eyes with three ommatidia. Ultimate rostral segment without accessory hairs, 86-108  $\mu$  long, 1.12-1.81 times as long as the second tarsal segment of the hind leg; length of the stylets 570-1080  $\mu$ . Spiracles on each side two, one between fore- and midleg, and one between mid- and hind leg. The legs pale brown or brown, the tibia of the fore leg 120-149  $\mu$  long, 0.22-0.38 times as long as the distance between the outer margins of the eyes. Each segment of complex II-VII marginally with one hair, and in *N. semiglabra* even a few hairs more, 14-40  $\mu$  long or 40-135  $\mu$ ; pleurally and spinally a few or several hairs, or hairs are lacking on the dorsum. Siphunculi with a pore 31-45  $\mu$  wide. Tergite VIII in *N. ficicola* with 6-8 hairs, in *N. semiglabra* with 8-10, in the other species with four, 35-159  $\mu$  long. Cauda with a knob and a constriction, transversely elongate, 46-97  $\mu$  wide, 12-35  $\mu$  long, with 7-13 hairs, 40-84  $\mu$  long. Subanal plate bilobed, with 10-22 hairs, 50-98  $\mu$  long. Subgenital plate with 2-4 anterior, and 12-24 posterior hairs. Gonapophyses two with 3-6 hairs, but in *N. semiglabra* hairs were not observable. Spiracles are lacking on the abdomen.

First stage larva of aptera (of *N. ficicola*, *N. multisetosa* and *N. semiglabra* lacking): Antenna with four segments, apical setae of the last segment 14-18  $\mu$  long. Groups of wax glands lacking, but 1-2 pustules on marginal and spinal sclerites wax gland-like. Siphunculi are present. Spiracles on each side two, on the thorax only.

Alate viviparous female.— (two species). In life black, the abdomen with green or brown. Wings sometimes blackish. Pterostigma grey or black. Macerated specimens: Body length 2.1-2.4 mm. The head smooth, without horns or dagger hairs, with three pairs of hairs anteriorly, and a posterior row of four hairs, 15-18  $\mu$  or 65-70  $\mu$  long, 0.03-0.04 and 0.14-0.15 times as long respectively as the width of the head across the eyes. Antennae with five segments, 0.28-0.38 times as long as the body, and 1.3-1.9 times the width of the head across the eyes; the processus terminalis 12-20  $\mu$  long. Antennal segments III-V with ring-shaped secondary rhinaria; the primary rhinaria are moulded with the secondary rhinaria to a complex structure, or distally on segment V observable as a separate oval structure; segment III with 15-23, IV with 9-12, and V with 5-9 annular rhinaria. The last rostral segment 98-123  $\mu$  long, 0.74-0.87 times as long as the second tarsal segment of the hind leg, without accessory

hairs; length of the stylets 370-430  $\mu$ . Eyes compound. Fore wing medial vein once branched, the hind wing with two oblique veins. Femora, tibiae and second tarsal segments with spinulose imbrications; the tibia of the fore leg 382-534  $\mu$  long, 0.79-1.15 times as long as the width of the head across the eyes; first tarsal segments of fore- and midleg with three, of the hind leg with two hairs. Second tarsal segment of the hind leg with four apical hairs with expanded tips. Abdominal segments I-VII marginally with pale brown or brown sclerites, those on segments IV-VII raised, with wrinkles and spinulose imbrications, each with one hair, in *N. javanica* 72-100  $\mu$  long. Tergite II-VI with a pair of pale brown spots, VII with one transversely elongate sclerite; tergite III-VII in *N. javanica* without hairs, in *N. brevipilosa* with 1-4 hairs, but sometimes without. Tergite VIII a transversely elongate brown plate with 4-9 hairs, in *N. javanica* 84-86  $\mu$  long, in *N. brevipilosa* 30-65  $\mu$ . Siphunculi situated on the marginal plate of segment VI, the pore 55-83  $\mu$  wide. Cauda a knob with a constriction, 106-137  $\mu$  wide, 43-63  $\mu$  long, with 9-13 hairs, the longest 35-104  $\mu$ . Subanal plate bilobed, with 15-18 hairs, the longest 65-96  $\mu$ . Subgenital plate with 11-16 anterior, and 12-16 posterior hairs. Gonapophyses two, each with 7-10 hairs, the longest 14-22  $\mu$ . Spiracles on abdominal segments I-V, on I very small.

Embryos from alata in *N. javanica* 465-750  $\mu$  long, almost as first stage larvae of apterae, but length of most hairs 20-40  $\mu$ .

Etymology.—Nipponaphis, aphid from Japan, name given by Pergande (1906).

***Nipponaphis brevipilosa* spec. nov.**  
(figs. 360-368)

Types.—Holotype (apterous viviparous female) from *Castanopsis argentea* (Bl.) DC. Cibodas (1400 m), Java, Indonesia, no. 1280-1-12, 26.ii.1978, leg. D. Noordam. Paratypes: 33 apterae viviparae and five alatae viviparae, the same data as holotype, and *Castanea* spec., Merbaboe (1000 m), 10.v.1916, leg. P. van der Goot. Holotype and paratypes apterae leg. D. Noordam in Rijksmuseum van Natuurlijke Historie, Leiden; paratypes alatae leg. P. v.d. Goot in the collection at the British Museum (Natural History), London.

Apterous viviparous female.—In life (pl. 34): Brown, antennae, legs, and borders of abdominal segments II-VII yellowish. Siphunculi a ring, darker brown than the surroundings. Pro-, meso-, metathorax and abdominal segment I vaulted with transverse deep furrows with distinct pits of intersegmental muscular plates. Eyes black. The body is covered with a transparent, but not shiny, layer of wax. Two pairs of spots of white wax on the sides of the body, between fore- and midleg, and between mid- and hind leg; a line with white wax runs from the midlegs to below the abdominal segments II-VII complex.

Macerated specimens.—(fig. 360; described from seven specimens). Body brown or pale brown, broadly obovate, 1.30-1.55 mm long, 1.0-1.3 times as long as it is wide, with three parts separated from each other by membranes without pustules: (1) head plus thorax plus abdominal tergite I (prosoma); the dorsum with pustules, with four deep furrows with intersegmental muscular plates; the furrows in the central area do not proceed to the pleural region, but a fifth, distal furrow, surrounds the anterior and lateral sides of (2), tergites II-VII, a complex with a thickened lateral and posteri-

or margin and a lateral and posterior crest; (3) segment VIII, free, with thickened lateral and posterior margins and a crest. (1) is 3.0-3.6 times as long as (2), and 7.0-8.9 times as long as (3). The dorsum bends gradually to the sides of the body and encircles and encloses on the posterior side, abdominal segment VIII, the cauda, subanal plate and subgenital plate.

Prosoma.— Anterior to the eyes and dorsal to the antennae the head shows a bend inwards; from the level of the eyes the head rises gradually 30-75  $\mu$  to the central area, which does not show a pair of raised rosettes (as in *N. javanica*); as everywhere on the prosoma densely covered with pustules 10-30  $\mu$  wide at the base and 6-10  $\mu$  high, circular, elliptical, ovate or more irregular, with a wall 4-6  $\mu$  thick, or in some areas no wall discernible; the surface of the pustules is dotted, reminding one of a wax gland structure. The frons dorsal to the antennae with three pairs of hairs, and four hairs in a transverse row posterior to the eyes, 14-23  $\mu$  long. Eyes with three ommatidia, distance between the outer margins of the eyes 410-480  $\mu$ , and width of the head across the eyes 440-750  $\mu$ . Antennae inserted 75-130  $\mu$  below the highest point of the head, and 60-80  $\mu$  below the eyes, with three segments, bent sideways on segment I, 228-257  $\mu$  long, 0.16-0.19 times as long as the body, and 0.51-0.62 times the distance between the outer margins of the eyes; segment I is basally fused with the head, length 33-47  $\mu$ , with a hair 10-17  $\mu$  long, segment II, 31-40  $\mu$  long, the hair 10-14  $\mu$ , segment III, 172-188  $\mu$  long, the distal rhinarium located 10-14  $\mu$  from the tip, the penultimate rhinarium 57-70  $\mu$ ; length of the 3-4 apical setae 10-12  $\mu$ . Ultimate rostral segment 96-102  $\mu$  long, 1.38-1.57 times as long as the second tarsal segment of the hind leg, length of the stylets 660-730  $\mu$ . The thorax, dorsal to the coxae of the fore legs bends inwards about 70  $\mu$ ; the areas with pustules of the thoracic segments are swellings, 120-150  $\mu$  raised above muscular plates, and there is a distinct furrow between pronotum and mesonotum, and between meso- and metanotum; the furrow between metanotum and abdominal segment I is almost lacking, 12-18  $\mu$  deep, the furrow between abdominal segments I and II is lacking spinally over a distance of about 150  $\mu$ , but starts from there, surrounding complex segments II-VII, and VIII; prothorax on each side two hairs and 4-8 dorsal hairs; mesothorax and metathorax on each side two hairs, and dorsally 8-10, and 7-8 respectively; abdominal segment I with one marginal and 5-6 dorsal hairs; all these hairs 10-20  $\mu$  long.

Complex abdominal segments II-VII. The lateral and posterior margin is internally thickened and medial to this frame are some curved ridges; the outer margin is a crest, anteriorly about eight  $\mu$  wide, posteriorly 20  $\mu$  and slanting downwards. Pustules, about six  $\mu$  high, are present on the whole surface of segment II, and some spinulose imbrications; the pustules decrease on segments III-VII, but spinulose imbrications increase, the spinulae less than one  $\mu$ , a furrow is observable between segments II-III, III-IV and VI-VII; each segment with one marginal hair, on segments II and III, 14-25  $\mu$  long, on segments IV-VII, 24-40  $\mu$ ; segments II and III, in the medial area each with 1-2 hairs, V with 0-1, 12-21  $\mu$  long. Siphunculi on segment VI, the thickened ring with a diameter of 41-45  $\mu$ , the colourless pore 10-14  $\mu$  wide. Abdominal segment VIII dorsally free, a brown plate, the middle area rising 40  $\mu$  above the sides, with a broadly rounded posterior margin, consisting of a radially striped crest, about 10-15  $\mu$  wide; the sides and posterior margin ventrally with a thickened ridge, 6-8  $\mu$  wide; the plate with rather flat irregular pustules and ridges, and the anterior area with spinulose imbrications, with four hairs, 35-40  $\mu$  long.

The margins of the prosoma curve to the ventral side, are provided with pustules, and bear on each side four hairs, inconspicuous, about 15  $\mu$  long; the margins proceed to the posterior side, encircling the complex II-VII and segment VIII, around VIII with a smooth rim, thickened about 15  $\mu$ , the venter protruding backwards 10-250  $\mu$  to the posterior margin of VIII. The venter from the frons of the head to the area just anterior to a line between the hind coxae is colourless and smooth or at the borders radially striped, without hairs; around this central area is a brown zone with pustules, 150-250  $\mu$  wide or even wider proceeding to the border of the body. Legs evenly pale brown; fore legs inserted at about 200  $\mu$  below the dorsum; tibia of the fore leg 133-145  $\mu$  long, 0.29-0.33 times as long as the distance between the outer margins of the eyes. First tarsal segments of fore- and midleg with three, of the hind leg with two hairs, 27-41  $\mu$  long; second tarsal segment of the hind leg 0.27-0.34 times as long as the tibia of the hind leg, and 0.14-0.16 times as long as the distance between the outer margins of the eyes, with two dorsoapical hairs, 43-51  $\mu$  long, sometimes with expanded tips, about two  $\mu$  wide. Empodial hairs of the hind leg 23-27  $\mu$  long. Length of the hind segments: femur fused with trochanter 172-182  $\mu$ , tibia 208-240  $\mu$ , 1.19-1.33 times as long as the femur, and 0.46-0.55 times the distance between the outer margins of the eyes, first tarsal segment 29-40  $\mu$ , second tarsal segment 65-71  $\mu$ . Spiracles about 170  $\mu$  ventral to the middle of the dorsum, on each side one between fore- and midlegs, and one between mid- and hind legs. Cauda pale brown, at the base 110-118  $\mu$  wide, with a knob 74-80  $\mu$  wide and 18-35  $\mu$  long, the constriction with a diameter of 61-70  $\mu$ , with 8-9 hairs, the longest 41-53  $\mu$ . Subanal plate brown, bilobed with 10-13 hairs, 51-72  $\mu$  long. Subgenital plate with 2-3 anterior hairs, 33-45  $\mu$  long, and 12-14 posterior hairs, 43-61  $\mu$  long. Gonapophyses two, each with 3-6 hairs, 8-14  $\mu$  long.

Alate viviparous female.— In life: Head, thorax, eyes and antennae black, abdomen dull brownish black. Pterostigma greyish black. Larvae dull dark brown, the dorsum with a reddish brown tinge; eyes black, antennae yellowish white, legs brownish yellow, siphunculi and cauda brownish black, white wax lacking (Van der Goot, unpublished).

Macerated specimens.— (figs. 361-367; described from three specimens). Body length 2.10-2.40 mm, 2.1-2.3 times as long as it is wide.

Head.— (fig. 361). Head brown, smooth, with especially close to the paired ocelli, rather flat ridges; width across the eyes 480-490  $\mu$ , anterior to the paired ocelli three pairs of hairs, posterior four hairs, 15-22  $\mu$  long, 0.03-0.04 times as long as the width of the head across the eyes. Ventrally posterior to the median ocellus hairs are lacking. Antennae pale brown, with pale brown rings in the bleached specimens, with five segments, 650-750  $\mu$  long, 0.28-0.31 times as long as the body, and 1.3-1.5 times the width of the head across the eyes; segment I somewhat wrinkled, segment II with irregularly arranged wrinkles, almost without spinulae; segments III-V (fig. 362) with ring-shaped secondary rhinaria, the rings are not closed on the dorsal side with a space of 2-25  $\mu$ ; between the rhinaria are 3-6 concentric imbrications, dorsally and ventrally with interconnections, and with indistinct spinulae; the rhinaria are 2-3  $\mu$  wide. The primary rhinaria are moulded with the secondary rhinaria to a complex structure, on segment V wider than the other rhinaria, and sometimes also with an oval accessory rhinarium; segment III with 15-22 annular rhinaria, IV with 9-12, V with 5-7; hairs on segments III-V are lacking, but on segment V four apical setae, 10-

14  $\mu$  long. Length of segment III, 265-345  $\mu$ , 1.7-2.0 times as long as IV, 2.1-2.9 times as long as V, and 0.9-1.2 times as long as IV plus V; segment IV, 155-170  $\mu$ , 1.2-1.4 times as long as V; segment V, 120-124  $\mu$  long. The last rostral segment (fig. 363) 98-108  $\mu$  long, 0.82-0.89 times as long as the second tarsal segment of the hind leg, without accessory hairs; length of the stylets 380-410  $\mu$ . Eyes brown in the bleached specimens, the ocular tubercle extending sideways 25  $\mu$ .

Thorax.— Sides of the prothorax brown, mesothorax brown. Fore wing (fig. 364) very pale brown, the basal area and the borders of the anal vein slightly darker, and an oval area bordered by the bases of cubitus, medial vein, radial sector and by the subcosta colourless; the medial vein once branched, median I is long, 1.5-2.2 times as long as the distance from the base of the fork to the base of the anal vein; anal vein and cubitus I united at a distance of 50-120  $\mu$  from the subcosta. Legs pale brown, the knees darker; femora, tibiae and second tarsal segments densely with not very striking spinulose imbrications, the spinulae 1-3  $\mu$  long; the tibiae of the fore leg 382-494  $\mu$  long, 0.8-1.1 times as long as the width of the head across the eyes, length of hairs of the hind tibia 30-35  $\mu$ ; chaetotaxy of first tarsal segments 3, 3, 2, the lateral hairs 2.3-2.8 times as long as the middle hair; length of hairs of the first tarsal segment of the hind leg 53-57  $\mu$ ; the four apical hairs of the second tarsal segment of the hind leg (fig. 365) with expanded tips, the dorsal hairs 67-69  $\mu$  long, the tips 5-6  $\mu$  wide; empodial hair of the hind leg with expanded tips, 33  $\mu$  long. Length of the hind segments: femur fused with trochanter 460-504  $\mu$ , tibia 605-685  $\mu$ , 1.31-1.38 times as long as the femur, and 1.2-1.5 times the width of the head across the eyes; first tarsal segment 45-47  $\mu$  long, second tarsal segment 113-131  $\mu$ .

Abdomen.— (fig. 366). Abdominal segments I-VII colourless, with on each of segments III-VII a marginal almost colourless roundish plate, with a diameter of 30-70  $\mu$  with spinulose imbrications, each with one hair, 16-55  $\mu$  long; in one specimen segment I with four dorsal hairs, II with three, III with two, IV and V each with one, VI with two, and VII with one, tergites VI and VII each with an indistinct transversely elongated plate with spinulose imbrications. Tergite VIII a pale brown, transverse elongate plate with spinulose imbrications, with 6-9 hairs 30-65  $\mu$  long. Siphunculi situated on segment VI, pale brown with concentric wrinkles and spinulose imbrications with a diameter of 80-110  $\mu$ ; the pore brown, with a diameter of 55-70  $\mu$ . Cauda (fig. 367) with a knob 106-121  $\mu$ , 43-45  $\mu$  long and with a constriction of about 90  $\mu$ , with 9-12 hairs, the longest 35-39  $\mu$ . Subanal plate bilobed, with 15-17 hairs, the longest 65-69  $\mu$ . Subgenital plate with 13-16 anterior hairs, 45-49  $\mu$  long, and 11-16 posterior hairs, 58-59  $\mu$  long. Gonapophyses two, each with 7-9 hairs, the longest 14-16  $\mu$ . Spiracles on four abdominal segments, II-V.

First stage larva of apterous viviparous female (fig. 368; description of one specimen): Body length 655  $\mu$ , length of head plus pronotum 263  $\mu$ , width of prothorax 365  $\mu$ , head across the eyes 248  $\mu$ . Frons of the head brown, also the pronotum, but the margins anterior and posterior to the eyes colourless, but the prothorax on each side with two brown roundish tubercles, all brown parts with pustules, and medial to the eyes a larger circular wax gland. Anterior to the eyes three pairs of hairs, between the eyes four hairs in a row, 14-33  $\mu$  long. Eyes black. Antennae with four segments, 287  $\mu$  long, pale brown, the last segment darker, segments III and IV with imbrications with indistinct spinulae, III, 140  $\mu$  long; IV, 79  $\mu$ ; length of hair on segment I, 20  $\mu$ ; on II, 12  $\mu$ ; hairs on segments III and IV are lacking, the four apical

setae, 14  $\mu$  long. Stylets 710  $\mu$  long.

Prothorax marginally on each side a hair on the two tubercles, and two spinal hairs, 19  $\mu$  long. Meso- and metathorax each with a marginal tubercle with two hairs, and a pair of spinal tubercles with one hair, all hairs 16-25  $\mu$  long. Tibia of the fore leg 133  $\mu$  long, the hind tibiae with a distal hair, 43  $\mu$  long, and two distal spines, 10  $\mu$  long. Abdominal segments I-VII each with a marginal tubercle with pustules and one hair, 20-40  $\mu$  long, segment I with a pair of spinal tubercles with one hair, 16  $\mu$  long, segment III with one hair only, 10  $\mu$  long, and the other segments without tubercles or hairs. Segment VIII a brown plate with some ridges and spinulose imbrications, with two hairs, 57  $\mu$  long. Siphunculi on segment VI, the pore with a diameter of 22  $\mu$ . Spiracles on each side two.

Host plant records.— Specimens were collected in Java: *Castanea* spec. (syn. *Castanopsis* spec.), Mt. Merbaboe (1000 m), 10.v.1916, leg. P. van der Goot; Tjiparay-Garoet (1100 m), viii.1916, leg. P. van der Goot, both in the collection at the British Museum (Natural History), Londen; *Castanopsis argentea* (Bl.) DC., Cibodas (1400 m), 26.ii.1978, leg. D. Noordam, in the collection at the Rijksmuseum van Natuurlijke Historie, Leiden.

The aphids live densely crowded on young and older twigs.

Alatae were collected 10.v.1916.

Etymology.— *Brevipilosa*, short hairy.

***Nipponaphis ficicola* Hille Ris Lambers & Takahashi, 1959**  
(figs. 369-370)

*Nipponaphis ficicola* Hille Ris Lambers & Takahashi, 1959: 7.

Types.— Cotypes, 17 slides with numerous apterous viviparous females, *Ficus benjamina*, Banjoewangi, 17.ix.1948, leg. F.W. Rappard, no. 63; *Ficus* spec., Kalibendo, 29.xi.1948, leg. F.W. Rappard, no. 95, in the collection at the British Museum (Natural History), London, and in the collection at Takahashi (Hille Ris Lambers & Takahashi 1959: 9).

Apterous viviparous female.— In life: Dark violet or blackish, dull, wrinkled (Dr Rappard's notes).

Macerated specimens.— (fig. 369; described from six specimens). Body brown or pale brown, broadly obovate, 975-1285  $\mu$  long, 1.1-1.4 times as long as it is wide, with three parts separated from each other by membranes without pustules: (1) head plus thorax plus abdominal tergite I (prosoma), and four pairs of distinct intersegmental plates, the pair on the pronotum without a furrow, the three other pairs with a transverse furrow connecting each two muscular plates; these furrows do not proceed into the pleural region, but a fifth distal furrow surrounds on the anterior and lateral sides (2), the tergites II-VII, a complex without a lateral crest; (3) segment VIII, free, without a lateral crest. (1) is 3.3-4.4 times as long as (2), and 9.0-11.6 times as long as (3). The dorsum bends gradually to the sides of the body and encircles and encloses the posterior side, abdominal segment VIII, the cauda, subanal plate and subgenital plate.

Prosoma.— Anterior to the eyes and dorsally to the antennae an inward bend is

lacking; the central area of the head is hardly raised above the level of the eyes, and does not show a pair of raised rosettes (as in *N. javanica*); prosoma with pustules 8-25  $\mu$  wide at the base and 4-10  $\mu$  high, circular or ovate with a wall 2-4  $\mu$  thick, the centre seen at the top bright, without wax gland structure; the pustules spaced 5-15  $\mu$  from each other, less densely distributed than in *N. brevopilosa* and *N. javanica*. The frons dorsal to the antennae with two pairs of hairs, and between the eyes more or less an anterior and a posterior row of four hairs, 67-108  $\mu$  long. Eyes darker than the surroundings, with three ommatidia, distance between the outer margins of the eyes 373-433  $\mu$ . Antennae being almost up to the level of the eyes and the dorsum of the head, with three segments, bent sideways on segment I, 202-232  $\mu$  long, 0.19-0.21 times as long as the body, and 0.53-0.60 times the distance between the outer margins of the eyes; segment I pale brown, basally not fused with the head, length 29-43  $\mu$ , with a hair 14-30  $\mu$  long; segment II, 29-35  $\mu$  long, with two hairs, 27-40  $\mu$  long; segment III, 151-186  $\mu$  long, the distal rhinarium located 0-4  $\mu$  from the tip, the penultimate rhinarium 51-67  $\mu$ , length of the 3-4 apical setae 18-20  $\mu$ . Ultimate rostral segment 86-96  $\mu$  long, 1.65-1.81 times as long as the second tarsal segment of the hind leg, length of the stylets 650-686  $\mu$ . The thorax dorsal to the coxae of the fore legs without a distinct bend inwards, and around the anterior spiracles pustules as on other parts of the sides; an elongate-oval transverse swelling is present on the middle of each of the thoracic segments and abdominal segment I raised about 50  $\mu$  above the four pairs of muscular plates; these muscular plates are connected to each other by a transverse furrow which continues also more or less pleurally; also longitudinally the muscular plates are connected by furrows; the furrows look sclerotic, with pustules; the furrow between abdominal segment I and the complex II-VII is 15-30  $\mu$  deep, but is lacking in the spinal area. The prothorax on each side with two hairs, the dorsum with 5-8 hairs, of which two anteriorly; the mesothorax on each side three or rarely two or four hairs, the dorsum with 7-11 hairs; metathorax on each side with three, rarely with two hairs, the dorsum with 5-6 hairs; abdominal segment I on each side with 2-3 hairs, the dorsum with 3-5 hairs; all these hairs 68-108  $\mu$  long, but some dorsal hairs 40-50  $\mu$  long.

Complex abdominal segments II-VII. The lateral margin with a swelling with curved ridges on segment II, segments III plus IV, segments V plus VI with the siphunculi, and on segment VII; the posterior margin of segment VII is straight, but the lateral swelling protrudes backwards about 20  $\mu$  with a rounded projection; each segment with a marginal hair, 86-114  $\mu$  long, and on segment VII up to 135  $\mu$ ; the outer margin without a crest. Segment II with pustules, also in the middle area, segments III-VII in the middle and pleurally with spinulose imbrications, the spinulae about one  $\mu$  long; on each of segments II-V one hair may be present in the middle area, 18-51  $\mu$  long. Siphunculi on segment V, the thickened ring with a diameter of 31-35  $\mu$ , the colourless pore 12-16  $\mu$  wide. Abdominal segment VIII dorsally free, a brown plate with, in the middle, an almost straight anterior margin and a broadly rounded thickened posterior margin, without a crest, with spinulose imbrications, with 6-8 hairs, 120-159  $\mu$  long, but some hairs 67-96  $\mu$ .

The margins of the prosoma curve to the ventral side and are evenly provided with pustules similar to those of the dorsum, with some hairs. The venter in the middle is flat and colourless with some hairs, 25  $\mu$  long; two or three distal abdominal segments, just anterior to the subgenital plate, are densely provided with spinulose

imbrications and a transverse row of hairs, 10-20  $\mu$  long. Legs pale brown; tibia of the fore leg 127-145  $\mu$ , 0.33-0.38 times as long as the distance between the outer margins of the eyes. First tarsal segments of fore- and midleg with three hairs, of the hind leg with two, 23-30  $\mu$  long; second tarsal segment of the hind leg 0.26-0.27 times as long as the tibia of the hind leg, and 0.13-0.14 times as long as the distance between the outer margins of the eyes, with two dorsoapical hairs, 39-47  $\mu$  long, without expanded tips. Empodial hairs are lacking. Length of the hind segments: femur fused with trochanter 159-169  $\mu$ ; tibia, 188-208  $\mu$ , 1.15-1.23 times as long as the femur, and 0.48-0.51 times the distance between the outer margins of the eyes, first tarsal segment 25-33  $\mu$ , second tarsal segment 51-55  $\mu$ . Spiracles one between fore- and midlegs and one between mid- and hind legs. Cauda pale brown, at the base 86-98  $\mu$  wide, with a knob 61-71  $\mu$  wide and 20-31  $\mu$  long, the constriction with a diameter of about 56  $\mu$ , with 10-13 hairs, the longest 61-80  $\mu$ . Subanal plate pale brown, bilobed with 18-22 hairs, 72-98  $\mu$  long. Subgenital plate with 2-4 anterior hairs, 25-47  $\mu$  long, and 18-20 posterior hairs, 51-63  $\mu$  long. Gonapophyses two, each with 5-6 hairs, 14-23  $\mu$  long.

Second or third stage larva of apterous viviparous female (fig. 370; one specimen): Body length 765  $\mu$ , distance between the outer margins of the eyes 279  $\mu$ , length of the head plus pronotum 240  $\mu$ , width of the pronotum 410  $\mu$ ; frons anteriorly pale brown, almost without pustules. Dorsal to the base of the antennae to dorsally between the eyes two pairs of hairs; between the eyes eight hairs, 78  $\mu$  long. Antennae with three segments, 224  $\mu$  long, length of hair on segment I, 23  $\mu$ ; on II, 33  $\mu$ ; segment III, 180  $\mu$  long, without hairs, but with four apical setae, 14  $\mu$  long, the processus terminalis eight  $\mu$  long, the penultimate rhinarium 70  $\mu$  from the tip. The prothorax on each side with two hairs, 65  $\mu$  long, and dorsally with two short anterior hairs, and two posterior hairs on a roundish sclerite, 61  $\mu$  long. Meso- and metathorax each on a marginal sclerite with three hairs, and dorsally each with a pair of sclerites each with one hair, and a smaller hair spinally. Tibia of the fore leg 135  $\mu$  long. Abdominal segment I on each side a sclerite with 2-3 hairs, dorsally a pair of sclerites, each with one hair, and one spinal hair. Abdominal segments II-VII marginally sclerotic with on each side six hairs, 66-80  $\mu$  long, dorsally without sclerites and without hairs. Siphunculi on segment V, the pore with a diameter of 23  $\mu$ . Segment VIII with four hairs, 112  $\mu$  long. The cauda presumably with four hairs.

Host plant records.— Specimens were collected in Java: *Ficus benjamina* L., Banjoewangi, 19.ix.1948, and *Ficus* spec., Kalibendo, 29.xi.1948, both leg. F.W. Rappard; *Ficus*?, Tjibodas 1.vi. - 30.vii.1956, Prof. P. Büchner, B21; all in the collection at the British Museum (Natural History), London.

The aphids live on the bark of one cm thick branches and on green twigs (note by Dr F.W. Rappard).

Etymology.— *Ficicola*, living on *Ficus*.

***Nipponaphis javanica* spec.nov.**  
(figs. 371-380)

Types.— Holotype (apterous viviparous female) from *Castanopsis acuminatissima* (Bl.) A. DC., Dieng (2000 m), Java, Indonesia, no. 871-5, 3.i.1977, leg. D. Noordam. Paratypes: three alatae viviparae, 32 last stage larvae of alatae, embryos of alatae,



and 12 larvae of apterae viviparae no. 871-1 to 871-17 with same data as holotype. Holotype and paratypes in the collection at the Rijksmuseum van Natuurlijke Historie, Leiden.

Apterous viviparous female.— In life (pl. 35): Brownish, with some wax powder, but furrows and segmental swellings distinctly observable.

Macerated specimen.— (fig. 371; described from one specimen). Body brown, obovate, 1795  $\mu$  long, 1.4 times as long as it is wide, with three parts separated from each other by brown membranes without pustules: (1) head plus thorax plus abdominal tergite I (prosoma); the dorsum, with pustules, proceeds far to the ventral side, and hides the ventrally situated membrane; four deep furrows with intersegmental muscular plates are present in the central area only, are lacking in the pleural region, but the fifth distal furrow surrounds on the anterior side and on the lateral sides: (2) tergites II-VII, a complex with thickened lateral and posterior margins and a lateral crest; (3) segment VIII free, with thickened lateral and posterior margins and a crest. (1) is 2.3 times as long as (2), and 8.3 times as long as (3). The dorsum bends gradually to the sides of the body.

Prosoma.— Anterior to the eyes and dorsally to the antennae the head shows a bend inwards; from the level of the eyes the head rises gradually about 100  $\mu$  to the central area with a pair of rosettes, the highest points of the head; as everywhere on the prosoma provided with pustules, 10-25  $\mu$  wide at the base and 6-15  $\mu$  high; the frons dorsal to the antennae with three pairs of hairs, and four hairs in a transverse row posterior to the eyes, 98-106  $\mu$  long. Eyes with three ommatidia, distance between the outer margins of the eyes 464  $\mu$ , and width of the head across the eyes 645  $\mu$ . Antennae inserted about 150  $\mu$  below the highest point of the head, and 70  $\mu$  below the eyes, with three segments, bent sideways on segment I, 228  $\mu$  long, 0.13 times as long as the body, and 0.49 times the distance between the outer margins of the eyes; segment I is basally fused with the head, maybe the segments are also fused together, but the borders are distinct; segment I is 50  $\mu$  long, with a hair 50  $\mu$  long; segment II, 45  $\mu$  long, the hair 50  $\mu$ ; segment III, 108  $\mu$  long, the distal rhinarium located 14  $\mu$  from the tip, the penultimate rhinarium 74  $\mu$ , length of the three apical setae 12  $\mu$ . Ultimate rostral segment 100  $\mu$  long, 1.12 times as long as the second tarsal segment of the hind leg, length of the stylets 570  $\mu$  long. The prothorax, dorsal to the coxae of the fore legs, bends inwards 40-80  $\mu$ ; the areas with pustules of the thoracic segments are swellings 90-110  $\mu$  raised above muscular plates and the two distinct furrows between pronotum and mesonotum, and between meso- and metanotum; the furrow between metanotum and abdominal segment I is 40  $\mu$  deep, the one between abdominal segment I and the complex segments II-VII, 15  $\mu$ ; prothorax on each side two hairs, and two dorsal hairs; mesothorax and metathorax on each side two hairs, and three dorsal hairs; abdominal segment I with one marginal and two dorsal hairs; all these hairs 100-125  $\mu$  long, but one spinal hair of meso- and metanotum 35-58  $\mu$ . Complex segments II-VII. The lateral and posterior margin is internally thickened and raised over the spinal area about 22  $\mu$ , and 30  $\mu$  over the pleural area; medial to the thickened lateral margin each segment shows an internal oval thickened structure, and the outer margin is a crest, anteriorly about 15  $\mu$  wide, posteriorly 25  $\mu$ . Pustules are present on the dorsum of segment II raised about 10  $\mu$ , but decrease in numbers on the distal segments and raised no more than six  $\mu$ ; a furrow is observable between segments II-III, and III-IV; imbrications with spinulae of

about one  $\mu$  are present on segments II-VII but increase to the distal segments; hairs are lacking on the dorsum, but each segment bears one marginal hair, 105-120  $\mu$  long. Siphunculi on segment VI, the thickened, darker brown ring with a diameter of 40-45  $\mu$ , the colourless pore 15  $\mu$  wide. Abdominal segment VIII dorsally free, a dark brown plate with broadly rounded posterior margin, the middle area raised 45  $\mu$  above the sides; the sides and posterior margin ventrally with a thickened ridge, 8-12  $\mu$  wide, and with a radially striped paler brown crest, about 15  $\mu$  wide, the plate with rather flat irregular pustules, internally thickened, without spinulose imbrications, with four hairs, 85-95  $\mu$  long.

The margins of the prosoma curve to the ventral side and are provided with pustules, and on each side are three hairs between fore- and midlegs, and one between mid- and hind legs, about 90  $\mu$  long; the margins proceed to the posterior side, encircling the complex II-VII and reaching ventrally to the middle of segment VIII; the venter from the frons of the head to the area just behind a line between the midlegs is smooth, but the area posterior to that line is covered with pustules. Fore legs inserted at the sides, about 350  $\mu$  below the dorsum; tibia of the fore leg 127  $\mu$  long, 0.27 times as long as the distance between the outer margins of the eyes. First tarsal segment of fore- and midleg with three hairs, of the hind leg with two. Length of the hind segments: femur fused with trochanter 161  $\mu$ , tibia 263  $\mu$ , 1.63 times as long as the femur, and 0.57 times the distance between the outer margins of the eyes; first tarsal segment 38  $\mu$  long, second tarsal segment 89  $\mu$ . Spiracles 250-300  $\mu$  ventral to the dorsum, one between fore- and midleg, the other between mid- and hind leg, lacking on the abdomen. Cauda brown, at the base 118  $\mu$  wide, with a knob 97  $\mu$  wide and 30  $\mu$  long, with 10 hairs, the longest 84  $\mu$ . Subanal plate brown, bilobed with 12 hairs, 80  $\mu$  long. Subgenital plate with four anterior hairs, 50  $\mu$  long, and 13 posterior hairs, 58  $\mu$  long. Gonapophyses two, each with four hairs, 12  $\mu$  long.

Alate viviparous female.— In life: Head, antennae, eyes and mesothorax black; abdomen green with brown marbling, with marginally five short teeth. Wings horizontal, blackish, with greyish pterostigma, the base with a white spot. Larvae greenish brown with yellowish head, thorax and marginal tubercles, but looking rather greyish due to some granular wax.

Macerated specimens.— (figs. 372-379; described from three specimens). Body length 2.21-2.42 mm, 1.9-2.3 times as long as it is wide.

Head.— (fig. 372-374). Head black, smooth, with especially close to the paired ocelli, rather flat ridges; width across the eyes 450-490  $\mu$ , anterior to the paired ocelli three pairs of hairs, posterior four hairs, 65-70  $\mu$  long, 0.14-0.15 times as long as the width of the head across the eyes. Ventrally posterior to the median ocellus hairs are lacking. Antennae brown, with black rings, with five segments, 810-850  $\mu$  long, 0.33-0.38 times as long as the body, and 1.6-1.9 times the width of the head across the eyes; segment I somewhat wrinkled, segment II with wrinkles arranged as an irregular network, almost without spinulae; segments III-V (fig. 373) with ring-shaped secondary rhinaria, the rings are not closed on the dorsal side, with a space of 15-35  $\mu$ ; between the rhinaria are 3-6 concentric spinulose imbrications, dorsally and ventrally with interconnections; the rhinaria are 2-3  $\mu$  wide. The primary rhinaria are moulded with the secondary to a complex structure, or distally, on segment V observable as a separate oval structure; segment III with 22-23 annular rhinaria, IV with 10-12, V with 7-9; hairs on segments III-V lacking, but on segment V four apical setae, 9-15  $\mu$

long. Length of segment III, 348-360  $\mu$ , 1.7-1.8 times as long as IV, 2.0-2.2 times as long as V, and 0.9-1.0 times as long as IV plus V; segment IV, 195-205  $\mu$ , 1.1-1.3 times as long as V; segment V, 158-170  $\mu$  long. The last rostral segment (fig. 374) 118-123  $\mu$  long, 0.74-0.78 times as long as the second tarsal segment of the hind leg, without accessory hairs; length of the stylets 370-430  $\mu$ . Eyes black, compound, the ocular tubercle extending sideways 25-30  $\mu$ .

Thorax.— Sides and partly the middle area of the prothorax brown, mesothorax brown or black. Fore wing (fig. 375) pale brown, the leading edge, the pterostigma, the basal area and the borders of the anal vein darker, and an oval area bordered by the bases of cubitus, medial vein, radial sector and by the subcosta almost colourless; the medial vein once branched, median I long, 1.9-2.5 times as long as the distance from the base of the fork to the base of the anal vein; anal vein and cubitus I united at the subcosta; the hind wing with two oblique veins. Legs pale brown, the dorsal side of the femora and the basal half of the tibiae brown; femora, tibiae (fig. 376) and second tarsal segments densely, with not very striking, spinulose imbrications, the spinulae 1-3  $\mu$  long; the tibia of the fore leg 510-534  $\mu$  long, 1.0-1.1 times as long as the width of the head across the eyes, length of the hairs of the hind tibia 61-69  $\mu$ ; chaetotaxy of first tarsal segments 3, 3, 2, the lateral hairs 3.2-4.0 times as long as the middle hair; length of hairs of the first tarsal segment of the hind leg 61-69  $\mu$ ; the four apical hairs of the second tarsal segment of the hind leg (fig. 377) with expanded tips, the dorsal hairs 67-74  $\mu$  long, the tips 5-6  $\mu$  wide; empodial hair of the hind leg with expanded tip 40  $\mu$  long. Length of the hind segments: femur fused with trochanter 543-551  $\mu$ , tibia 755-787  $\mu$ , 1.39-1.43 times as long as the femur, and 1.5- 1.7 times the width of the head across the eyes; first tarsal segment 47-49  $\mu$  long, second tarsal segment 151-165  $\mu$ .

Abdomen.— (fig. 378). Abdominal segments I-VII colourless, with on each segment a marginal pale brown or brown, oval or somewhat irregular sclerotic plate with a diameter of about 75  $\mu$ , those on segments IV-VII, 20-40  $\mu$  raised, with wrinkles and spinulose imbrications, each with one hair, 72-100  $\mu$  long; segment I with a pair of spinal hairs, segments II-VI each with a pair of transverse elongate, pale brown spots, those of V and VI with some spinulose imbrications, tergite VII with one spinal, transverse elongate spot with spinulose imbrications; segment II with 1-2 spinal hairs 37-58  $\mu$  long; the dorsum of segments III-VII without hairs; segment I ventrally with 5-8, hairs; II, 11-13; III, 14-17; IV, 23-25; V, 17-20; VI, 21-24, about 60  $\mu$  long. Tergite VIII a brown; transverse elongate plate, e.g. 130  $\mu$  long, and 410  $\mu$  wide, with broadly rounded posterior margin, with spinulose imbrications and around the hairs with radially aranged ridges; with 4-6 hairs, two of these on the slightly raised medial part, 84-86  $\mu$  long. Siphunculi situated on the marginal plate of segment VI, almost colourless to brown with concentric wrinkles and some spinulose imbrications; the pore black with a diameter of 60-65  $\mu$ , and on the same plane with the surroundings. Cauda (fig. 379) at the base 165-180  $\mu$  wide, with a knob 133-137  $\mu$  wide, 52-63  $\mu$  long and with a constriction of 120  $\mu$  diameter, with 12-13 hairs, the longest 88-104  $\mu$ . Subanal plate bilobed, with 15-18 hairs, the longest 88-96  $\mu$ . Subgenital plate with 14-16 anterior hairs, 59-68  $\mu$  long, and 12-15 posterior hairs, 74-90  $\mu$  long. Gonapophyses two, each with 7-10 hairs, the longest 20-22  $\mu$ . Spiracles on five abdominal segments, I-V.

First stage larva of apterous viviparous female.— (fig. 380; description of one

specimen). Body length about 800  $\mu$ , length of head plus pronotum 248  $\mu$ , width of prothorax 310  $\mu$ , head across the eyes 310  $\mu$ ; frons of the head brown with some pustules, the area between the eyes with pustules and spinulae, anterior to the eyes three pairs of hairs, between the eyes four hairs in a row, 118-123  $\mu$  long. Antennae with four segments, 236  $\mu$  long, segment III with imbrications with indistinct spinulae, 94  $\mu$  long; IV with imbrications with indistinct spinulae, 75  $\mu$  long; length of hair on segment I, 68  $\mu$ ; on II, 39  $\mu$ , lacking on III and IV, the four apical setae, 15-18  $\mu$  long. Stylets 470  $\mu$  long. Prothorax marginally on each side two hairs and one tubercle, dorsally with two pairs of tubercles with spinulae of about one  $\mu$ , and 1-3 ovals with a diameter of 12  $\mu$ , on each of the posterior tubercles one hair, 78  $\mu$  long. Meso- and metathorax each with a marginal tubercle with two hairs and a pair of spinal tubercles with one hair. Tibia of the fore leg 114  $\mu$  long, length of distal hairs 30-55  $\mu$  long, the hind tibiae distally with two spines, 14  $\mu$  long. All first tarsal segments with two hairs, about 45  $\mu$  long. Two dorsoapical hairs of the second tarsal segment of the hind leg with expanded tips, 53  $\mu$  long. Abdominal segments I-VI each with a marginal tubercle with one hair, 72-86  $\mu$  long, and a pair of spinal tubercles, I with one hair 18-31  $\mu$  long, the other spinal tubercles without hairs; segment VII with a marginal tubercle with one hair, VIII with two spinal hairs, 100  $\mu$  long. Siphunculi on segment VI, the pore with a diameter of 22  $\mu$ . Spiracles on each side on segments I-V, on I much smaller than on the other segments.

Embryos of alate viviparous females differ from first stage larvae of apterae: Hairs dorsally on the head, marginal and dorsal hairs on thorax and abdomen are shorter and frequently blunt, 20-47  $\mu$  long; marginal and spinal tubercles are lacking. Medial to the eyes on each side two, and close to the spinal hairs on the pronotum one elliptical wax gland is observable, diameter about 12  $\mu$ .

Host plant records.— Specimens were collected in Java: *Quercus* spec., Patak Banteng (Dieng, 2570 m), .viii.1916, leg. P. van der Goot, in the collection at the British Museum (Natural History), London; *Castanopsis acuminatissima* (Bl.) A.DC., Dieng (2000 m), 3.i.1977, leg. D. Noordam, in the collection at the Rijksmuseum van Natuurlijke Historie, Leiden.

The aphids live densely crowded on young sprouts, and according to P. van der Goot (in his manuscript) on the upper and lower sides of the youngest leaves, living close together along the midrib.

Alatae were collected .viii.1916, and 3.i.1977.

Etymology.— Javanica, from Java, the island where the aphid was collected.

### *Nipponaphis multisetosa* spec.nov.

(figs. 381, 382)

Types.— Holotype (apterous viviparous female) from *Castanopsis javanica* (Bl.) DC., Cibodas (1400 m), Java, Indonesia, no. 1281-2, 26.ii.1978, leg. D. Noordam. Paratypes: four apterous viviparous females, and one larva, the same data as the holotype. Holotype and paratypes in the collection at the Rijksmuseum van Natuurlijke Historie, Leiden.

Apterous viviparous female.— In life: About as *N. brevopilosa*.

Macerated specimens.— (fig. 381; described from five specimens). Body brown

or black, obovate or broadly obovate, 1.32-1.66 mm long, 1.2-1.5 times as long as it is wide, with three parts separated from each other by membranes without pustules: (1) head plus thorax plus abdominal tergite I (prosoma); the dorsum with pustules, and four pairs of distinct intersegmental muscular plates, the pair on the pronotum without a furrow, the three other pairs with a transverse furrow connecting each two muscular plates; these furrows do not proceed into the pleural region, but a fifth distal furrow surrounds on the anterior and lateral sides part (2), tergites II-VII, a complex with thickened lateral and posterior margins, and a lateral crest; (3) segment VIII, free, with thickened lateral and posterior margins and a crest. (1) Is 3.6-4.4 times as long as (2), and 8.7-10.0 times as long as (3). The dorsum bends gradually to the sides of the body, and encircles and encloses on the posterior side abdominal segment VIII, the cauda, subanal plate and subgenital plate.

Prosoma.— Anterior to the eyes and dorsal to the antennae an inward bend almost lacking; from the level of the eyes the head rises gradually 200-300  $\mu$  to the central area; prosoma with pustules 15-25  $\mu$  wide at the base and 2-6  $\mu$  high, circular or ovate with a structure of wax glands; an area lateral, and posterior to the eyes smooth, without pustules. The frons dorsal to the antennae to posterior to the eyes with more than 30 hairs, 82-94  $\mu$  long. Eyes with three ommatidia, distance between the outer margins of the eyes 488-535  $\mu$ . Antennae inserted 200-300  $\mu$  below the highest point of the head, and 150  $\mu$  below the eyes, with three segments, bent sideways on segment I, 210-253  $\mu$  long, 0.14-0.16 times as long as the body, and 0.47-0.48 times the distance between the outer margins of the eyes; segment I brown, is basally fused with the head, length 31-40  $\mu$  (the medial side about 45  $\mu$  long, the lateral side 10  $\mu$ ), with a hair 33-35  $\mu$  long; segment II, 31-40  $\mu$  long, the hair 20-43  $\mu$ ; segment III, 172-204  $\mu$  long, the distal rhinarium located 12-16  $\mu$  from the tip, the penultimate rhinarium 67-72  $\mu$ , length of the four apical setae 10-12  $\mu$ . Ultimate rostral segment 97  $\mu$  long, 1.40 times as long as the second tarsal segment of the hind leg, length of the stylets 650  $\mu$ . The thorax dorsal to the coxae of the fore legs without a distinct bend inwards, but dorsal to the anterior spiracula a band of pustules, 6-8  $\mu$  wide at the base, and 6-14  $\mu$  high; in the spinal area several or just a few flat pustules, the thoracic segments with swellings 60-90  $\mu$  raised above the muscular plates, and a distinct furrow between pro- and mesonotum, meso- and metanotum, metanotum and abdominal segment I; spinally abdominal segment I curves downwards on the posterior side, but a border between segments I and II is only distinctly observable on the lateral sides where it surrounds complex II-VII, and segment VIII. The number of dorsally observable marginal plus dorsal hairs on the prothorax is about 70, on the mesothorax 50, on the metathorax 35, and on abdominal segment I, 30, of different lengths, the longest on each segment 80-122  $\mu$ , the shortest 40-80  $\mu$ .

Complex abdominal segments II-VII. The lateral and posterior margin is internally thickened, brown or blackish, and also the posterior margin of segment II and the anterior margin of III is thickened; the outer margin is a yellowish crest, 25-35  $\mu$  wide, protruding horizontally. The surface of the complex with spinulose imbrications, and the pleural area sometimes with some pustules, which are more distinct on segment II. Each of the segments II-VII with a marginal hair, that of VI located slightly more submarginally, length of the hairs 50-100  $\mu$ , segment II with 2-3 spinal hairs, 90-103  $\mu$  long; segment III with 0-1 pleural, and one spinal hair 30-67  $\mu$  long; segment IV with 0-1 pleural and spinal hairs; segment V with 0-2 pleural hairs, VI in

one specimen with one hair posteromedial to a siphunculus, all 40-60  $\mu$  long; VII with two spinal hairs, 70-90  $\mu$  long. Siphunculi on segment VI, the thickened ring with a diameter of 33-40  $\mu$ , the colourless pore about 10  $\mu$  wide. Abdominal segment VIII dorsally free, a brown or black flat plate with broadly rounded posterior margin, the sides and posterior margin ventrally with a thickened ridge, 8  $\mu$  wide, and with a radially striped crest, 12-25  $\mu$  wide, with a smooth surface with only a few spinulose imbrications, with four hairs, 65-118  $\mu$  long.

The margins of the prosoma curve to the ventral side, the frons is densely provided with pustules as present dorsally on the body, the sides of the body are provided with two pairs of bands, which bear dense pustules up to 12  $\mu$  high; dorsal to the legs the sides are almost smooth without pustules, but ventral to the coxae pustules are present 100-150  $\mu$  down to the flat venter; hairs on the sides numerous, the longest about 80  $\mu$ . Legs colourless or brown, the fore legs inserted at about 450  $\mu$  below the dorsum; tibia of the fore leg 120-130  $\mu$  long, 0.22 times as long as the distance between the outer margins of the eyes. First tarsal segments of fore- and mid-leg with three, of the hind leg with two hairs, about 38  $\mu$  long; second tarsal segment of the hind leg 0.32-0.35 times as long as the tibia of the hind leg, and 0.13-0.14 times as long as the distance between the outer margins of the eyes, with two dorsoapical hairs, 52  $\mu$  long. Length of the hind segments: femur fused with trochanter, 160-169  $\mu$ , tibia 197-216  $\mu$ , 1.23-1.28 times as long as the femur, and 0.37 times the distance between the outer margins of the eyes, first tarsal segment 35  $\mu$ , second tarsal segment 67-69  $\mu$ . Spiracles 200-300  $\mu$  ventral to the middle of the dorsum, one pair between fore- and midlegs, the other between mid- and hind legs. Cauda brown, at the base 110-118  $\mu$  wide, with a knob 72-78  $\mu$  wide and 22-27  $\mu$  long, the constriction with a diameter of 58-65  $\mu$ , with eight hairs, the longest 53-69  $\mu$ . Subanal plate brown, bilobed, with 13-14 hairs, 50-72  $\mu$  long. Subgenital plate anterior hairs not observable, posterior hairs 10-14, 42-47  $\mu$  long. Gonapophyses no hairs observable.

Second stage larva of apterous viviparous female (fig. 382; one specimen): Body length 915  $\mu$ , length of head plus pronotum 365  $\mu$ , width of prothorax 590  $\mu$ , distance between the outer margins of the eyes 345  $\mu$ , width of the head across the eyes 362  $\mu$ ; frons of the head brown with pustules not higher than two  $\mu$ ; the area between the eyes with pustules, but rather indistinct in the spinal area. Dorsal to the base of the antennae to the eyes nine hairs, between the eyes eight hairs, the longest 125-135  $\mu$ . Antennae with three segments, 280  $\mu$  long, segment III only distally with a few spinulose imbrications, 202  $\mu$  long; length of hair on segment I, 48  $\mu$ , on II, 38  $\mu$ , lacking on III, but the four apical setae, 14  $\mu$  long. The prothorax on each side with an anterior pale brown tubercle with one hair, and a posterior tubercle with two hairs, 120-155  $\mu$  long, and 2-3 smaller hairs outside the tubercles; dorsally a pair of tubercles, each with two hairs, 110-150  $\mu$  long, and outside the tubercles four hairs, about 55  $\mu$  long. Meso- and metathorax each with a marginal tubercle with four hairs, and a pair of dorsal tubercles each with two hairs, 130-150  $\mu$  long, and smaller hairs outside the tubercles. Tibia of the fore leg 137  $\mu$  long, with hairs about 40  $\mu$  long, the hind tibiae distally with two spines, 8-10  $\mu$  long. First tarsal segments of fore- and midleg with three hairs, of hind leg with two, of the hind leg 40  $\mu$  long. Two apical hairs of the second tarsal segment of the hind leg acute, 40  $\mu$  long. Abdominal segment I with marginal tubercles with two hairs and a pair of dorsal tubercles, each with one hair, 75-145  $\mu$  long, and several smaller hairs outside the tubercles. Abdominal segments

II-VII each with one marginal hair, II dorsally with a pair of tubercles each with one hair, and VII dorsally with one plate with two hairs, 75-145  $\mu$  long, some smaller hairs pleurally, anterior to the siphunculi. Siphunculi on segment VI, the pore with a diameter of 20-22  $\mu$ . Segment VIII with four hairs, 125  $\mu$  long. Cauda brown, with a median process, 20  $\mu$  wide, 10  $\mu$  long, and six hairs.

Host plant records.— Specimens were collected in Java: *Castanopsis javanica* (Bl.) DC., Cibodas (1400 m), 26.ii.1978, leg. D. Noordam, in the collection at the Rijksmuseum van Natuurlijke Historie, Leiden.

The aphids live on young and older twigs.

Etymology.— Multisetosa, with many hairs.

***Nipponaphis semiglabra* spec. nov.**

(figs. 383, 384)

Types.— Holotype (apterous viviparous female) from *Lithocarpus bennettii* (Miq.) Rehd., Bogor, Kebun Raya, Java, Indonesia, no. 1004-1, 12.viii.1977, leg. D. Noordam. Paratypes: five, plus four bleached, apterous viviparous females, and three larvae, the same data as the holotype and no. 408, 31.viii.1975, with the same data as the holotype. Holotype and paratypes in the collection at the Rijksmuseum van Natuurlijke Historie, Leiden.

Apterous viviparous female.— In life (pl. 36): Body brown with a slightly paler band from the head to the complex of segments II-VII, and a paler transverse line at the posterior margin of the prothorax and of abdominal segment I. Two black spots on the prothorax, and three rows, each of four black spots, on mesothorax to abdominal segment I. Posterior area of the complex of abdominal segments II-VII darker than the anterior part. Abdominal segment VIII constitutes together with the posterior upper part of the belly, a black oval which encircles the cauda and the subanal plate. Sides of the body brown. Eyes black. Siphunculi a brown ring. Antennae and legs paler than the body. Dorsal side covered by a smooth transparent layer of wax, which looks only whitish when damaged; border between dorsum and margin with a narrow wax line, most clear in the posterior half of the body. On each side two spiracula visible as small buttons with white wax.

Macerated specimens.— (fig. 383; described from six specimens). Body pale brown, broadly ovate, 1.24-1.48 mm long, 1.1-1.2 times as long as it is wide, with three parts separated from each other by membranes: (1) head plus thorax plus abdominal tergite I (prosoma); the dorsum almost smooth, with four pairs of distinct intersegmental muscular plates, only the pair between pro- and mesonotum and the pair between metanotum and abdominal segment I with a distinct transverse furrow. A furrow between abdominal segments I and II proceeds pleurally and surrounds on the anterior and lateral sides: (2) the tergites II-VII, without thickened lateral and posterior margins with brown transverse ridges in the middle area, indicating borders of segments, which proceed to the margins between segments II-III, and VI-VII, but three furrows are restricted to the spinal area between segments III-VI, a lateral crest is lacking; (3) segment VIII black, free without thickened lateral and posterior margin and without a crest. (1) Is 4.0-6.9 times as long as (2), and 11.3-17.2 times as long as (3). The dorsum bends gradually to the sides of the body, and encircles and

encloses on the posterior side abdominal segment VIII, the cauda, anal plate and subgenital plate.

**Prosoma.**— Anterior to the eyes and dorsal to the antennae an inward bend is lacking; the central area of the head is hardly raised above the level of the eyes; prosoma flat, the spinal area not raised above the margins, pustules 2-6  $\mu$  high in a spinal area on the prothorax and along the margins of furrows, in all other areas present as almost flat ovals, with dots of one  $\mu$ . The frons dorsal to the antennae to posterior to the eyes with about 20 hairs, 55-72  $\mu$  long. Eyes with three ommatidia, distance between the outer margins of the eyes 385-425  $\mu$ . Antennae inserted 30-50  $\mu$  below the dorsum of the head, and somewhat less to the level of the eyes, with four segments, bent sideways on segment I, 244-279  $\mu$  long, 0.19-0.22 times as long as the body, and 0.65-0.72 times the distance between the outer margins of the eyes; segment I brown, the medial side 47-61  $\mu$  long, the lateral side 20-30  $\mu$ , with a hair 27-55  $\mu$  long, segment II, 37-43  $\mu$  long, the hair 27-50  $\mu$ ; segment III, 139-155  $\mu$  long, 1.7-2.2 times as long as IV, with 2-5 hairs, 35-51  $\mu$  long, the penultimate rhinarium located 71-78  $\mu$  from the tip; segment IV, 69-82  $\mu$  long, with two hairs, 33-40  $\mu$  long, the distal rhinarium located 17-20  $\mu$  from the tip, length of the four apical setae 14-18  $\mu$ . Ultimate rostral segment 90-108  $\mu$  long, 1.54-1.71 times as long as the second tarsal segment of the hind leg, length of the stylets 700-1080  $\mu$ . The thorax dorsal to the coxae of the fore legs without an inward bend and without a band of pustules dorsal to the anterior spiracula; the thoracic segments flat, but the muscular plates are pits, about 50  $\mu$  deep. Transverse furrows as mentioned above. The pro-, meso- and metathorax dorsally each with about 20-25 hairs, 55-74  $\mu$  long, abdominal segment I with 8-16 hairs, 59-67  $\mu$  long.

Complex abdominal segments II-VII. Segments II and III with pale brown margins, the rest almost colourless, IV and V pale brown, VI pale brown margins, the area between the siphunculi brown, and VII wholly brown, the segments separated from each other by transverse furrows, which between segments V and VI are only observable between the siphunculi, but which proceed to the margins between III-IV and VI-VII; the segments each with 1-2 marginal hairs, 0-3 hairs on each segment anterior and posterior to the siphunculi, and usually two hairs spinally on each segment, the number of marginal plus dorsal hairs on segment VII, 6-13, length of the hairs 45-90  $\mu$ . Siphunculi on segment VI, the thickened ring with a diameter of 43-45  $\mu$ , the colourless pore 18-20  $\mu$  wide. Abdominal segment VIII dorsally free, brown or black, with rounded anterior margin, and the posterior margin emarginate 20-55  $\mu$ , without distinct thickened ridges, the surface with spinulose imbrications, with 8-10 hairs, 75-92  $\mu$  long.

The margins of the prosoma curve towards the ventral side, the frons is densely provided with oval pustules, 2-4  $\mu$  high, the sides as well, the pustules around the spiracula and legs not differing from the other pustules; usually the sides overlap the dorsum, and are provided with numerous hairs, the longest on each segment 60-78  $\mu$ ; the margins of the prosoma proceed to the posterior side, encircling the complex II-VII and segment VIII. The venter from the frons of the head to the area just behind a line between the hind coxae is colourless, flat and smooth, with about five fine hairs, 25  $\mu$  long. Legs pale brown, the fore legs inserted at about 150  $\mu$  below the dorsum, tibia of the fore leg 130-149  $\mu$  long, 0.34-0.37 times as long as the distance between the outer margins of the eyes. First tarsal segments of fore leg with six hairs, 15-20  $\mu$  long, of midleg with three or sometimes four hairs, of hind leg with two



hairs, 22-29  $\mu$  long; second tarsal segment of the hind leg 0.29-0.32 times as long as the tibia of the hind leg, and 0.14-0.15 times as long as the distance between the outer margins of the eyes, with two dorsoapical hairs, one of which with a slightly expanded tip, 40-47  $\mu$  long. Length of the hind segments: femur fused with trochanter, 155-179  $\mu$ , tibia 178-208  $\mu$ , 1.09-1.16 times as long as the femur, and 0.46-0.50 times the distance between the outer margins of the eyes, first tarsal segment 27-31  $\mu$ , second tarsal segment 53-63  $\mu$ . Spiracles about 100  $\mu$  ventral to the marginal overlap of the dorsum, one pair between fore- and midlegs, the other between mid- and hind legs. Cauda hardly developed, a knob 46-51  $\mu$  wide, and 12-16  $\mu$  long, with 7-8 hairs, 40-53  $\mu$  long. Subanal plate blackish, bilobed, with 20 hairs, 67-78  $\mu$  long. Subgenital plate with 2-4 anterior hairs, 23-51  $\mu$  long, and 19-24 posterior hairs, 25-40  $\mu$  long. Gonapophyses two, with 3-5 hairs, 10-12  $\mu$  long.

Second stage larva of apterous viviparous female (fig. 384: one specimen): Body length 630  $\mu$ , eyes about 50  $\mu$  ventral to the dorsum of the head, distance between the outer margins of the eyes 279  $\mu$ , width of the head across the eyes 315  $\mu$ , length of the head plus pronotum 228  $\mu$ , width of the pronotum 393  $\mu$ ; frons anteriorly with some almost flat pustules. Dorsal to the base of the antennae to the eyes 12 hairs, dorsal to the eyes eight hairs, the longest 50  $\mu$ . Antennae with four segments, 282  $\mu$  long, length of hair on segment I, 30  $\mu$ ; on II, 22  $\mu$ , segment III smooth, 145  $\mu$  long, with four hairs, 30  $\mu$  long, segment IV, 80  $\mu$  long with a few smooth imbrications, with one or two hairs, and four apical setae. The prothorax to each side with small pustules and three hairs, about 45  $\mu$  long, dorsally smooth, with two anterior hairs, and four posterior, 45  $\mu$  long. Meso- and metathorax each marginally with small pustules and four hairs, dorsally smooth, each with four hairs, about 45  $\mu$  long. Tibia of the fore leg 129  $\mu$  long, with hairs about 30  $\mu$  long, the hind tibiae distally with one spine. First tarsal segments of the fore leg with five hairs, of the midleg with three, of the hind leg two, about 20  $\mu$  long. Two apical hairs of the second tarsal segment of the hind leg with expanded tips. Abdominal segment I marginally with pustules, with two hairs, dorsally with four, 52  $\mu$  long; segments II-IV each with one marginal hair and two spinal hairs; V with one marginal, and two submarginal hairs, and two spinal hairs; VI with one marginal and one submarginal hair, and without spinal hairs; VII with one marginal and two spinal hairs. Siphunculi on segment VI, the pore with a diameter of 30  $\mu$ . Segment VIII with four hairs, about 60  $\mu$  long. Cauda with two hairs.

Host plant records.— Specimens were collected in Java: *Lithocarpus bennettii* (Miq.) Rehd., Bogor, Kebun Raya, 31.viii.1975, and 12.viii.1977, leg. D. Noordam, in the collection at the Rijksmuseum van Natuurlijke Historie, Leiden.

The aphids live on older twigs in small numbers, larvae walk but adults are fixed in their place.

Etymology.— Semiglabra, nearly smooth, referring to the appearance of the adults in life which are rather smooth due to a transparent cover of wax.

#### Genus *Pseudoregma* Doncaster, 1966 (figs. 385-431)

*Pseudoregma* Doncaster, 1966: 159 (type species *Oregma bambusicola* Takahashi, 1921).  
*Oregma*; Van der Goot, 1917: 171, 177, 205, 230.

Description (six species).— Apterous viviparous female.— In life: Yellow, yellowish violet, brown or black, with one marginal and two longitudinal spinal columns of wax; sometimes also pleurally on thoracic and abdominal segments columns of wax; the area between the wax columns with a thin layer of wax powder, or with a layer of wax which can break into white scales. *P. bambusicola* is greenish brown or black, grey due to whitish wax powder, and with a longitudinal median line of wax columns, and pleurally and marginally lines of wax; usually these lines of wax are lacking and the distal end of the abdomen is covered with a thick cushion of wax.

Macerated specimens.— Body colourless, with small brown sclerites or wholly brown, 1.1-2.8 mm long, 1.3-2.1 times as long as it is wide. The head fused with the pronotum, but the other segments of the body distinctly defined. The head with pustules with an irregular more or less star-shaped outline, with dotted surface, with a diameter of 6-14  $\mu$ , or long and stretched. The head with two horns, tapering to the ends, with rounded or sharp tips, 20-75  $\mu$  long, with 6-12 hairs, 2-14  $\mu$  long; medial to the eyes an oval group of wax glands or wax glands are lacking; the head dorsally and ventrally with normal slender hairs. Antennae with four or five segments, 170-476  $\mu$  long, 0.13-0.23 times as long as the body, and 0.54-0.90 times the width of the head across the eyes; the last antennal segment 1.8-4.5 times as long as its processus terminalis. The eyes with three ommatidia. Ultimate rostral segment without accessory hairs, 0.54-0.96 times as long as the second tarsal segment of the hind leg; stylets 230-545  $\mu$  long. Length of the head plus pronotum 0.62-0.82 times the width of the prothorax. The pronotum pleurally with a groove, passing from the posterior margin to a large muscular plate anteriorly; on each side of the median line is an elongate-oval swelling, which falls sharply at the pleural groove, at the anterior and posterior sides and at the median groove; pustules distinct on the swellings and marginally; on each side two marginal hairs, and dorsally 2-23; posteromarginally a group of 0-8 wax glands, spinally two groups of 0-11; especially in old populations and populations with alatae wax glands may be lacking. Meso- and metathorax wholly sclerotic, or marginally and a small or large part of the median area; marginally on each side on each segment two hairs and a group of 0-11 wax glands, dorsally 4-29 hairs and two groups of 0-13 wax glands on each segment. The second tarsal segments and in *P. pendleburyi* also the femora with some spinulae, other parts of the legs almost smooth; tibia of the fore leg 0.61-1.23 times as long as the width of the head across the eyes. First tarsal segments of fore- and midleg with 3-4 hairs, of the hind leg with two. Second tarsal segments of the hind leg with 1-2 dorsoapical hairs expanded at the tips; empodial hairs 33-50  $\mu$  long.

Abdominal segments I-VII with pale brown marginal sclerites, usually well-defined, but sometimes some are fused, or fused with dorsal sclerites; sometimes the sclerites are confined to the plate with wax gland groups; the tergites, one transverse pale brown elongate plate or each tergite divided into two or as in *P. bambusicola* up to 16 sclerites, the area in between being colourless. Tergites I-V with 2-18, and in *P. bambusicola* with up to 37 hairs; tergite VI with 1-10, VII with 1-4 hairs. On each segment one oval group of wax glands may be present marginally, and two groups on each tergite; but especially in populations with alatae some or all groups of wax glands are lacking. Pustules (star-shaped wax glands) are most distinct on the sclerotic parts of the abdomen. S-shaped wax glands are mainly ventral, but in *P. bambusicola* also dorsal on segments VI and VII. Tergite VIII a transverse elongate, pale

brown, plate with spinulose imbrications, 4-10 hairs, and with or without a spinal group of up to 14 wax glands. Siphunculi located dorsally on segment V, with 1-7 hairs on or near to the pale brown cone; the pore brown, 15-40  $\mu$  elevated above the base, 29-88  $\mu$  wide. Cauda transversely elongate, 90-195  $\mu$  wide at the base, the knob 55-143  $\mu$  wide and 25-61  $\mu$  long, with a diameter of the constriction of 25-104  $\mu$ , with 8-24 hairs, the longest 57-120  $\mu$ . Subanal plate bilobed, with 11-25 hairs, the longest 55-116  $\mu$ . Subgenital plate with 2-6 anterior, and 7-18 posterior hairs. Gonapophyses two, each with 1-14 hairs.

First stage larvae of apterous viviparous females exist as the type which develops into adult specimens, and in a "soldier" type which does not develop in later stages. Of only one species, *P. nicolai*, were soldiers not observed. Siphunculi are lacking in both types.

Alate viviparous female.— (four species). In life greenish black or black. The pterostigma of the fore wing greyish black or black.

Macerated specimens.— Body length 1.6-2.5 mm. The head with two frontal horns, up to 35  $\mu$  long, or the horns are lacking, but 5-17 hairs occur on their location, 4-7  $\mu$  long. Ventrally, posterior to the median ocellus, 7-16 hairs on each side. Antennae with five segments, 0.32-0.50 times as long as the body, and 1.4-2.1 times the width of the head across the eyes, the tip of the last segment, distal to the ultimate rhinarium 16-38  $\mu$  long. Antennal segments III-V with ring-shaped secondary rhinaria; between the rhinaria 3-6 concentric spinulose imbrications; the primary rhinaria between the annular rhinaria and moulded with them to a complex structure; segment III with 16-47, IV with 6-20, V with 4-14 annular rhinaria. Last rostral segment 0.58-0.89 times as long as the second tarsal segment of the hind leg; length of the stylets 244-518  $\mu$ . Eyes compound. Fore wing medial vein once branched, the hind wing with two oblique veins. First tarsal segment with four hairs, of the midleg with 3-4, of the hind leg with two. Second tarsal segment of the hind leg with 0-1 dorsoapical hair, expanded at the tip. Abdominal segments I-V or I-VI colourless, segment VI sometimes with some small pale brown spots, VII with one transverse elongate band or with a pleural interruption, VIII with a transverse elongate pale brown plate; tergite IV with 2-13 hairs, 14-28  $\mu$  long, VIII with 5-12 hairs, 25-47  $\mu$  long. Siphunculi located on segment V, a pale brown sclerite extending backwards 25-84  $\mu$  or at most 10  $\mu$ , with up to 10 hairs on the brown sclerite or near to the siphunculi. Cauda transversely elongate, a knob with a constriction, the knob 61-111  $\mu$  wide, and about twice as wide as it is long, with 11-30 hairs, the longest 37-74  $\mu$ . Subanal plate bilobed, with 15-23 hairs, the longest 49-80  $\mu$ . Subgenital plate with 6-19 anterior, and 8-19 posterior hairs. Gonapophyses two, each with 5-14 hairs, the longest 14-30  $\mu$ .

Embryos in alatae are similar to those in apterae, but in one collection of *P. panicola* the embryos lack horns and groups of wax glands, and hairs are blunt. The species live on Gramineae, Zingiberaceae, and according to Van der Goot (1917) Hypoxidaceae.

Etymology.— Pseudoregma, false *Oregma*, name proposed by Doncaster (1966) to replace *Oregma* sensu Takahashi, 1931, because *Oregma* Buckton, 1893 (type species *Oregma bambusae* Buckton, 1893) has become a junior synonym of *Astegopteryx* Karsch, 1890 (Hille Ris Lambers, 1953).

***Pseudoregma bambusicola* (Takahashi, 1921)**  
(figs. 385-396)

*Oregma bambusicola* Takahashi, 1921: 89.

*Oregma bambusae*; Buckton, 1893: 87; Buckton, 1894: 108; Van der Goot, 1917: 177.

*Pseudoregma bambusicola*; Doncaster, 1966: 158.

*Pseudoregma albostrigata* Liao, 1976: 544, **syn. nov.**

Apterous viviparous female.— In life (pls 37-39): Body greenish brown or greenish black. Head, antennae and legs pale brown, the last segment of the antennae darker. Eyes black. A groove posterior to the thoracic segments and abdominal segment I, between the other abdominal segments no grooves observable. The abdomen distally brown. In large (old) populations the body looks grey due to a waxy whitish powder, and the body distal to the siphunculi is covered with a white wax cushion. Especially in smaller populations, a white band of wax extends into the middle from the head to the white cushion at the end of the body, and on each side such a band is present anterior to the siphunculi to the pronotum or even to the head; the lower side is wholly covered with white wax. Larvae greenish with wax similar the adults or with less wax. In a population of two specimens only, the three dorsal bands of wax consisted of wax columns, and along the margin of the body were 10 columns of wax on each side, and two on the head.

Macerated specimens.— (figs. 385-388; described from 14 specimens).— Body 1.52-2.60 mm long, 1.3-1.9 times as long as it is wide.

Head.— Head brown or pale brown, with pustules with an irregular, more or less star-shaped outline, with dotted surface, about two  $\mu$  high, with a diameter of 6-10  $\mu$ , or long and stretched, up to 30  $\mu$  long; frons not protruding in the middle, head across the eyes 358-614  $\mu$  wide. Horns tapering to the tips, with rounded or sharp tips, with about 12 hairs, 2-4  $\mu$  long at the tip, and up to 10  $\mu$  at the base; length of horns 40-65  $\mu$ , 0.08-0.12 times as long as the width of the head across the eyes. Head dorsally with 8-14 anterior hairs, and 6-10 between the eyes, the longest 47-76  $\mu$ . Wax glands medial to the eyes number 1-10 on each side, and are lacking in 45 out of 82 specimens; in eight out of 24 populations all specimens were without wax glands on the head. Antennae with four or five segments, pale brown or brown, the last segment darker, 271-476 long, 0.15-0.19 times as long as the body, 0.66-0.81 times the width of the head across the eyes, and 0.61-0.77 times as long as the tibia of the fore leg; the segments are smooth or at most the last segments with some smooth imbrications. In four-segmented antennae III, 110-180  $\mu$  long, 1.4-1.8 times as long as IV, with 5-8 hairs, 30-47  $\mu$  long; segment IV 72-108  $\mu$  long, the processus terminalis 27-42  $\mu$  long with two hairs and five apical setae. In five-segmented antennae III, 110-139  $\mu$  long, 1.5-1.6 times as long as IV, 0.97-1.15 times as long as V, with 4-6 hairs; IV, 75-92  $\mu$  long, 0.65-0.74 times as long as V, with 3-4 hairs; V, 113-125  $\mu$  long, the processus terminalis 38-45  $\mu$  long, with two hairs and five apical setae. Eyes darker brown than the head, with three ommatidia. Ultimate rostral segment 94-118  $\mu$  long, 0.54-0.71 times as long as the second tarsal segment of the hind leg; stylets 405-545  $\mu$  long.

Thorax.— Prothorax brown or pale brown, with pustules, fused with the head, pleurally a groove maybe observable passing from the posterior margin to a large muscle plate anteriorly, but more striking are two elongate-oval swellings along the posterior margin, one on each side of the median line, raised 25-40  $\mu$ , and falling

sharply especially at the anterior and posterior sides; on each side two marginal hairs, dorsally 2-8 anterior hairs, and 8-15 posterior hairs; posteromarginally a group of 1-8 wax glands may be present, and spinally two groups of up to six wax glands. Mesothorax brown, but a small or large part of the median area colourless, with pustules, marginal wax glands may be present in a group of up to 10 oval glands, and two groups of wax glands may be present spinally with up to four glands, dorsally with 13-24 hairs. Metathorax marginally with a brown sclerite, the dorsum colourless with 6-8 small, brown sclerites, each with 1-4 hairs, or with two large sclerites; all sclerites with star-shaped pustules, the dorsum with 14-29 hairs; marginally a group with up to five glands, spinally two groups each with up to three glands. Legs evenly brown or pale brown, almost smooth, but the second tarsal segments on the plantar side with spinulose imbrications. Tibia of the fore leg 350-685  $\mu$  long, 0.89-1.23 times as long the width of the head across the eyes, the highest values in populations with alatae. First tarsal segments of fore- and midlegs with four hairs, the lateral hairs 2.1-3.6 times as long as the middle hairs, the segments of the hind leg with two hairs, 33-50  $\mu$  long; second tarsal segment of the hind leg 0.19-0.26 times as long as the tibia of the hind leg, and 0.30-0.38 times as long as the width of the head across the eyes, with one dorsoapical hair expanded at the tip, 61-84  $\mu$  long, the tip 2-3  $\mu$  wide. Empodial hairs of the hind leg 33-50  $\mu$  long. Length of the segments of the hind leg: femur with trochanter 389-685  $\mu$ , tibia 547-1015  $\mu$ , first tarsal segment 40-55  $\mu$ , second tarsal segment 134-200  $\mu$ ; the tibia is 1.32-1.50 times as long as the femur.

Abdomen.— Abdominal segments I-VII with pale brown marginal sclerites, those on segments VI and VII smaller and paler; the dorsum of segments I-V colourless with on each 12-16 pale brown sclerites with pustules and one or more hairs, the dorsum of VI colourless, with 2-6 very pale brown sclerites, and VII colourless, or sometimes with two small very pale brown sclerites or a transverse elongate plate with spinulose imbrications. Segments marginally usually with 2-4 hairs on each side, the tergite of I with 10-35 hairs, II with 12-31, III, 8-36; IV, 8-37; V, 12-30; VI, 4-10; and VII, 2-3 or exceptionally four; length of hairs on tergite IV, 50-80  $\mu$ ; ventrally on IV, 31-60  $\mu$ . Tergite VIII with a transverse elongated pale brown plate, e.g. 400  $\mu$  wide, and 100  $\mu$  long, the anterior side rounded, the posterior emarginate, with spinulose imbrications, and 6-10 hairs, the lateral of these beside the plate, 45-110  $\mu$  long. Three types of wax glands on the body should be distinguished: 1. Oval wax glands with a border about one  $\mu$  wide, with facets with a diameter of 2-4  $\mu$ , single or arranged in groups, marginally on each segment, and spinally from head to abdominal segment VIII; these glands are most developed in specimens of young populations (fig. 385), producing obvious columns of wax, gradually they decrease in older populations, and are frequently lacking in specimens (fig. 386) of populations with alatae; number of wax glands medial to the eyes at each side 0-10; marginal wax glands on each side, prothorax 0-8, mesothorax 0-11, metathorax 0-5, abdominal segment I, 0-6; II, 0-8; III, 0-8; IV, 0-10; V, 0-8; VI, 0-9; VII, 0-9. And spinal wax glands on the pronotum to abdominal segment IV in one or two groups, on segments V-VII usually in one; each group numbers on the pronotum 0-7 glands, on mesonotum 0-6, on metanotum 0-3, on abdominal segment I, 0-3; II, 0-3; III, 0-3; IV, 0-4; V, 0-3; VI, 0-4; VII, 0-2; and VIII, 0-4. 2. S-shaped wax glands (fig. 385a) present ventrally, and dorsally on segments VI and VII and in many specimens anterior to the siphunculi in a spinal band proceeding even to some spots on the head, and on each side in a pleural

band proceeding to the mesonotum; these glands obviously produce the cushion of wax on the distal abdominal segments, and three bands of segmental patches of wax anterior to the siphunculi. 3. Star-shaped wax glands (fig. 388) described above as the pustules present on all sclerotic brown parts of the body; on abdominal segments VII and VIII they occur anterior to the spinulose imbrications and in old populations they can be observed on all colourless parts of the abdominal tergites, replacing also the s-shaped wax glands anterior to the siphunculi. These wax glands obviously produce the white wax powder which gives especially to the specimens in old populations a grey appearance. Siphunculi located dorsally on segment V, pale brown, with some concentrically arranged spinulose imbrications, at the base 72-208  $\mu$  wide, about twice as wide as the diameter of the pore, with 1-6 hairs; pore brown, elevated above the base about 30  $\mu$ , the margin of the pore 55-140  $\mu$  from the margin of the abdomen, diameter of the pore 35-88  $\mu$ . Cauda transversely elongate, e.g. 192  $\mu$  wide at the base, the knob 133  $\mu$  wide, the length of the knob 59  $\mu$ , and the diameter of the constriction 74  $\mu$ ; the knob 59-143  $\mu$  wide, with 9-24 hairs, the longest 71-120  $\mu$ . Subanal plate bilobed, with 18-25 hairs, the longest 80-116  $\mu$ . Subgenital plate with 4-6 anterior hairs, 38-65  $\mu$  long, and 7-16 posterior hairs, 41-69  $\mu$  long. Gonapophyses two, each with 7-14 hairs, the longest 12-20  $\mu$ .

Alate viviparous female.— In life: Body greenish black. Eyes and antennae black. Legs pale, femora and tibiae distally black. Tarsi black. Pterostigma of the fore wing on the side of the subcosta bordered with black, other veins whitish (Van der Goot, 1917).

Macerated specimens.— (figs. 389-394; described from 12 specimens). Body length 1.72-2.47 mm, 1.7-2.3 times as long as it is wide.

Head.— (fig. 389). Head black, dorsally with blunt spinulae of about one  $\mu$  diameter, anterior to the paired ocelli with concentric wrinkles; width across the eyes 430-520  $\mu$ , in the area dorsal to the horns to between the paired ocelli 4-11 hairs, the longest 20-23  $\mu$ , posterior to the paired ocelli 6-10 hairs. Frons with two horns with rounded tips, 15-35  $\mu$  long, with about 14 hairs on the horn and near the base, about four  $\mu$  long. Ventrally, posterior to the median ocellus, 12-16 hairs on each side. Antennae brown, with black rings, with five segments, 790-1010  $\mu$  long, 0.35-0.50 times as long as the body, and 1.7-2.0 times the width of the head across the eyes; segment I somewhat wrinkled, segment II with some longitudinal wrinkles, and dorsally and ventrally with spinulose imbrications, the spinulae 2-3  $\mu$  long; segments III-V (fig. 390) with ring-shaped secondary rhinaria, the rings are not closed on the dorsal side, and sometimes also not on the ventral side, with a space of 20-50  $\mu$ ; between the rhinaria are 3-6 concentric spinulose imbrications, dorsally and ventrally with interconnections; the rhinaria are 3-4  $\mu$  wide. The primary rhinaria are between the annular rhinaria and moulded with them to a complex structure; segment III with 28-47 annular rhinaria, IV with 11-20, V with 4-13; hairs of segment III, 12-16  $\mu$  long. Length of segment III, 386-510  $\mu$ , 2.2-2.7 times as long as IV, 2.5-3.6 as long as V, and 1.2-1.5 as long as IV plus V; segment IV, 157-210  $\mu$  long, 1.0-1.5 times as long as V; V, 130-185  $\mu$  long, the processus terminalis 24-38  $\mu$ . The last rostral segment is 98-116  $\mu$  long, 0.63-0.70 times as long as the second tarsal segment of the hind leg, without accessory hairs; length of the stylets 400-518  $\mu$ . Eyes compound, the ocular tubercle extending sideways about 25  $\mu$ .

Thorax.— Sides and dorsum of the prothorax pale brown or almost colourless,

the mesothorax dark brown. Fore wing (fig. 391) medial vein once branched, the hind wing with two oblique veins. Legs brown, the distal end of the femur, the base and distal end of the tibia and the tarsi darker, the second tarsal segments with spinulose imbrications; the tibia of the fore leg 563-766  $\mu$  long, 1.30-1.68 times as long as the width of the head across the eyes, length of hairs of the hind tibia 37-50  $\mu$ ; chaetotaxy of first tarsal segments 4, 4, 2, the lateral hairs of the fore tarsus 1.8-2.5 times as long as the middle; length of hairs of the first tarsal segment of the hind leg 25-43  $\mu$ ; usually one dorsoapical hair on the second tarsal segment of the hind leg (fig. 392) with expanded tip, 61-76  $\mu$  long, the tip 2-3  $\mu$  wide; length of the empodial hair of the hind leg 40-47  $\mu$ . Length of the hind segments: femur fused with trochanter 508-582  $\mu$ , tibia 752-967  $\mu$ , 1.5-1.6 times as long as the femur, and 1.6-2.0 times the width of the head across the eyes; first tarsal segment 39-49  $\mu$  long, second tarsal segment 139-171  $\mu$ .

Abdomen.— (fig. 393). Abdominal segments I-V colourless, VI colourless or with a very pale brown marginal sclerite and 6-8 pale brown dorsal sclerites; VII margins and dorsum with one pale brown plate with a colourless pleural incision and sometimes a colourless strip along the posterior margin, with some spinulose imbrications; VIII pale brown, colourless along the borders, emarginate at the posterior margin 8-30  $\mu$ , pleurally with a denticle 6-10  $\mu$  high, with spinulose imbrications; number of hairs on tergites II-V, 4-7; on IV, 18-28  $\mu$  long, ventrally on segment IV, 21-29  $\mu$  long; on tergite VI, 4-6 hairs; on VII, 2-4; on VIII, 6-10, 37-47  $\mu$  long. Siphunculi (fig. 394) located on tergite V, colourless but posteriorly with a pale brown sclerite, anteriorly usually not observable, but extending backwards 40-84  $\mu$ , bearing 1-5 hairs; the pore yellowish brown, elevated about 5  $\mu$  above the surroundings, diameter of the pore 35-55  $\mu$ . Cauda transversely elongate, e.g. 153  $\mu$  wide at the base, the knob 94  $\mu$  wide, 53  $\mu$  long, and diameter of the constriction 67  $\mu$ ; the knob is 84-111  $\mu$  wide, with 17-30 hairs, the longest 61-74  $\mu$ . Subanal plate bilobed, with 19-23 hairs, the longest 61-80  $\mu$ . Subgenital plate with 6-9 hairs on the plate, the longest 40-51  $\mu$ , and 15-19 hairs along the posterior margin, the longest 43-53  $\mu$ . Gonapophyses two, each with 9-14 hairs, the longest 20-30  $\mu$ . Spiracles on six abdominal segments, II-VII.

First stage larvae of apterous viviparous females exist as the type which develops into adult specimens, and into a "soldier" type, which does not develop into later stages. The soldier type occurs only in older populations, in nine out of 22 populations. It should be shown whether intermediate stages exist between the two types, but a description is given below of a distinct specimen of both.

First stage larva of apterous viviparous female (fig. 395; description of one specimen): Body length 820  $\mu$ , length of head plus pronotum 273  $\mu$ , width of prothorax 332  $\mu$ , width of the head across the eyes 271  $\mu$ ; the head dorsally with five anterior hairs, and two rows each of four hairs between the eyes, about 40  $\mu$  long. Antennae with four segments, 271  $\mu$  long, segment III dorsally smooth, 96  $\mu$  long, IV with smooth imbrications, 94  $\mu$  long; length of hair on segment II, 29  $\mu$  and on III, 32  $\mu$ . Frons with two horns, pointed, smooth, 82  $\mu$  long, and 43  $\mu$  wide at the base, with hairs 4-6  $\mu$  long. Fore legs normal, the femur 270  $\mu$  long, and 65  $\mu$  wide in the middle, 1.00 times as long as the width of the head across the eyes; tibia of the fore leg not curved at the basal part, 324  $\mu$  long; length of distal hairs of the hind tibia 57  $\mu$ . All first tarsal segments with two hairs, about 78  $\mu$  long. Two dorsoapical hairs of the second tarsal segment of the hind leg with expanded tips, 78  $\mu$  long, the other apical

hairs smaller and acute. Medial to the eyes on each side a group of wax glands, marginal wax gland groups on the thoracic segments and abdominal segments I-VII, and a pair of spinal wax glands on each of the thoracic segments and abdominal segments I-V; spinal wax glands lacking on abdominal segment VII, and on segment VIII one group about 15  $\mu$  wide and long; borders of the wax glands in the groups usually indistinct. Abdominal segments dorsal to the marginal wax glands with one hair, tergite I with six hairs, tergites II-VI with four, VII-VIII with two, on VIII, 40  $\mu$  long. Cauda with two hairs, 40  $\mu$  long. Siphunculi absent. First stage larvae born of apterae in old populations are larger, show disappearance of marginal and spinal wax glands.

First stage larva, "soldier" (fig. 396; description of 1-9 specimens). Body length 1220  $\mu$  (970-1220  $\mu$ ), length of head plus pronotum 375  $\mu$  (318-393  $\mu$ ), 0.98 (0.83-1.02) times the width of the prothorax; width of the head across the eyes 369  $\mu$  (301-369  $\mu$ ); the head dorsally with five anterior hairs and between the eyes an anterior row of five hairs, and a posterior row of four hairs, two of which spinal far posterior, about 40  $\mu$  long; ventrally on each side 5-6 hairs, the longest 114  $\mu$ . Antennae with four segments, 332  $\mu$  (295-358  $\mu$ ) long, segment III, 129  $\mu$ , with a few smooth imbrications, IV with almost smooth imbrications, 98  $\mu$  long, length of hair on segments II and III about 33  $\mu$ . Frons with two horns, pointed, smooth, 232  $\mu$  (137-232  $\mu$ ) long, and 80  $\mu$  wide at the base, with hairs, not more than four  $\mu$  long. Fore legs more sclerotic and more sturdy than the other legs; femur of the fore leg 551  $\mu$  long, and 145  $\mu$  wide in the middle, 1.49 times as long as the width of the head across the eyes; tibia of the fore leg curved at the basal part, 574  $\mu$  long; distal hairs of the hind tibia 110  $\mu$  long. All first tarsal segments with two hairs, of the hind leg 100  $\mu$  long; diameter of the base of the first tarsal segment of the fore leg 43  $\mu$ , 1.5 times as wide as that of the hind leg. Two dorsoapical hairs of the second tarsal segment of the hind leg with expanded tips, 114  $\mu$  long, the other apical hairs smaller and acute.

Marginal and spinal wax gland groups usually lacking. Tergite I with six hairs, II-VI with four, VII and VIII with two hairs, on VIII about 60  $\mu$  long. Cauda with two hairs, 50  $\mu$  long. Siphunculi absent.

Embryos in alatae are similar to those of apterae, with horns, but with more groups of wax glands.

Host plant records.— Specimens were collected in Java on the plants, in the places, and on the dates indicated, while the collectors are indicated by numbers between parentheses: P. van der Goot or Van der Goot (1917), (1), partly in the collection at the Laboratorium voor Entomologie, Wageningen; F.W. Rappard (2), in the collection at the British Museum (Natural History), London; and D. Noordam (3), in the collection at the Rijksmuseum van Natuurlijke Historie, Leiden. Bamboo, Pasoe-roean, vi.1914, ii-vi.1916; Kepoeh; Mt. Merbaboe (700 m), viii.1913; Boemi Djawa (1000 m); Salatiga (572 m); Siti Ardja (Preanger, 1100 m); Bogor, 25.vii.1918 (1); *Gigantochloa apus* (Bl. ex Schult. f.) Kurz, Banjoewangi (0 m), 17.vi.1948, 4.viii.1948, 28.x.1948; bamboo, Bondowoso (250 m), 24.vii.1950, 28.vii.1950 (2); bamboo, Sindanglaya (1100 m), 29.iv.1975 (3); *Dendrocalamus giganteus* Munro, Bogor, Kebun Raya, 21.ii.1976 (3); bamboo, Bogor, Kebun Raya, 22-II-1976 (3); bamboo, Bogor, 5. ix.1976 (3); bamboo, Bogor, Kebun Raya, 8.ix.1976, 9.ix.1976 (3); *Bambusa arundinacea* (Retz.) Willd., Bogor, Kebun Raya, 10.ix.1976 (3); bamboo, Bogor, Kebun Raya, 23. xii.1976 (3); bamboo, Purwokerto, 29.xii.1976 (3); bamboo, Wonosobo (1000 m), 2.i.



1977 (3); bamboo, Sindanglaya (1100 m), 24.i.1977, 12.ii.1977 (3); bamboo, Bogor (500 m), 30.iv.1977 (3); bamboo, Sindanglaya (1100 m), 6.ix.1977 (3); bamboo, Bogor, Kebun Raya, 30.x.1977 (3); bamboo, Cipanas (1000 m), 14.xi.1977 (3); bamboo, Lawang (500 m), 25.xii.1977, 27.xii.1977 (3); bamboo, Bogor, Kebun Raya, 8.i.1978, 11. ii.1978, 17.ii.1978 (3).

The aphids are deposited by alatae on the lower side at the base of a leaf, and specimens of new populations live on the base of leaves, but old populations live on the stems, frequently densely crowded from the base to the upper part of fully grown stems, and eaten by the large larvae of *Synonycha grandis* Th. (Coccinellidae).

Alatae or larvae of alatae were collected viii.1913, vi.1914, 29.iv.1975, 9.ix.1976, 6.ix.1977, 14.xi.1977, and 17.ii.1978.

Etymology.— *Bambusicola*, living on *Bambusa*, one of the genera of bamboos.

***Pseudoregma montana*** (Van der Goot, 1917)  
(figs. 397-405)

*Oregma montana* Van der Goot, 1917: 205.

*Pseudoregma montana*; Eastop & Hille Ris Lambers, 1976: 366.

Types.— Neotype (apterous viviparous female, here designated) from bamboo, Sindanglaya (1100 m), 21.x.1975, leg. D. Noordam, no. 425-5-1, in the collection at the Rijksmuseum van Natuurlijke Historie, Leiden.

Van der Goot left no types, but apterae and alatae identified by Van der Goot still exist, but they were collected after the dates given in his 1917 book. A neotype is designated which is consistent with the description by Van der Goot (1917): An aptera with less distinct and small wax glands on the thoracic segments.

Apterous viviparous female.— In life (pl. 40): Yellowish violet or purple-brown, the head and anterior part of the thorax always more yellowish. Eyes black, antennae and legs yellowish. Pore of the siphunculi a black ring. Cauda yellow. The body dusted with wax powder but the colour of the body shows through; columns of wax, observable as white dots in marginal rows on the thoracic segments and abdominal segments I-VII, in two spinal rows from head to abdominal segment VI, lacking on VII, and only one column on VIII. The columns on VI and VIII are the largest, and in old populations many of the anterior columns are lacking. Larvae are bright yellow or somewhat orange, with dots of wax.

Macerated specimens.— (fig. 397; described from 10 specimens). Body 1.93-2.76 mm long, 1.7-2.1 times as long as it is wide.

Head.— Head pale brown, with pustules having an irregular, more or less star-shaped outline, with dotted surface, about one  $\mu$  high, with a diameter of 8-10  $\mu$ , or long-stretched up to 20  $\mu$  long; frons not protruding in the middle, head across eyes 435-496  $\mu$  wide. Horns tapering to the tips, with rounded or sharp tips, with about 12 hairs, 2-4  $\mu$  long at the tip, and up to 10  $\mu$  at the base; length of horns 38-75  $\mu$ , 0.08-0.15 times as long as the width of the head across the eyes. Head dorsally with 6-12 anterior hairs, and six between the eyes, the longest 28-53  $\mu$ . Wax glands medial to the eyes are usually lacking, but specimens in young populations bear 1-8 wax glands on each side, arranged in an oval group with a diameter up to 70  $\mu$ , the

glands with interspaces between one other, or without and then squeezed flat against each other. Antennae with four or five segments, pale brown, the last segment slightly darker, 275-435  $\mu$  long, 0.13-0.19 times as long as the body, 0.60-0.81 times the width of the head across the eyes, and 0.70-0.92 times as long as the tibia of the fore leg; the segments are smooth, but the last segment with some smooth imbrications. In four-segmented antennae III, 108-165  $\mu$  long, 1.1-1.4 times as long as IV, with 3-5 hairs, 12-28  $\mu$  long; segment IV, 94-115  $\mu$  long, the processus terminalis 25-35  $\mu$  long, with two hairs and five apical setae. In five-segmented antennae III, 69-108  $\mu$  long, 1.0-1.4 times as long as IV, 0.68-0.97 times as long as V, with 1-2 hairs; IV, 59-88  $\mu$  long, 0.56-0.73 times as long as V, with three hairs; V, 98-120  $\mu$  long, the processus terminalis 29-39  $\mu$  long, with two hairs and five apical setae. Eyes darker brown than the head, with three ommatidia. Ultimate rostral segment 81-101  $\mu$  long, 0.54-0.66 times as long as the second tarsal segment of the hind leg; stylets 314-410  $\mu$  long.

Thorax.— Prothorax pale brown, with pustules, fused with the head, pleurally a groove is observable passing from the posterior margin to a large muscular plate anteriorly, about 25  $\mu$  deep in relation to the swelling along the posterior margin which falls sharply at these grooves, on the anterior and posterior sides, and at a median groove; on each side two marginal hairs, 2-3 anterior and 2-5 posterior hairs; posteromarginally 0-7 wax glands on each side, and spinally two groups of 0-8 wax glands. Mesothorax with a large marginal sclerite, and a pair of dorsal sclerites pale brown with pustules, the rest of the mesothorax colourless and with indistinct pustules, marginal wax glands may be present in a group of up to 8 oval glands, and two spinal groups each of 0-13 glands; dorsally with 4-16 hairs. Metathorax marginally with a pale brown sclerite with pustules, and 0-8 wax glands, the tergite with two small pale brown sclerites with 1-12 wax glands, dorsally with 4-16 hairs. Legs evenly pale brown, smooth, but the second tarsal segments on the plantar side with spinulose imbrications. Tibia of the fore leg 370-488  $\mu$  long, 0.76-1.06 times as long as the width of the head across the eyes. First tarsal segments of fore- and midlegs with four hairs, the lateral hairs 1.9-2.7 times as long as the middle hairs, the segments of the hind leg with two hairs, 31-56  $\mu$  long; second tarsal segments of the hind leg 0.19-0.23 times as long as the tibia of the hind leg, and 0.31-0.35 times as long as the width of the head across the eyes, with one dorsoapical hair expanded at the tip, 69-84  $\mu$  long, the tip 2-3  $\mu$  wide. Empodial hairs of the hind leg 37-40  $\mu$  long. Length of the segments of the hind leg: femur plus trochanter 433-567  $\mu$ , tibia 573-811  $\mu$ , 1.30-1.47 times as long as the femur, first tarsal segment 39-49  $\mu$ , second tarsal segment 133-159  $\mu$ .

Abdomen.— Abdominal segments I-VII with pale brown, oval, marginal sclerites with a diameter on segment I of e.g. 50  $\mu$ , and 90  $\mu$  on segment VII; in specimens of young populations these sclerites are almost completely filled with oval wax glands, 20-40  $\mu$  diameter; in specimens of older populations in which alatae may be present, the glands are smaller and disappear, especially from the anterior (and thoracic) segments; the wax glands there are replaced by star-shaped pustules; the wax glands on the marginal segments number: I, 0-6; II, 0-6; III, 1-8; IV, 1-9; V, 0-8; VI, 6-12; VII, 5-10. The tergites are colourless, with spinally on each of segments I-VI a pair of sclerites almost completely filled with wax glands, the numbers of which are less in specimens of old populations but decrease less than on the marginal sclerites, and hardly any pustules are present on the sclerites; the wax glands on each spinal sclerite num-

ber: I, 4-13; II, 3-11; III, 3-10; IV, 1-10; V, 1-9; VI, 0-6. On segment VII usually no spinal wax glands are present, but sometimes one wax gland only on one side is present. Tergite I with 5-11 hairs; II with 7-13; III, 7-18; IV, 9-16; V, 10-14; VI, 3-8; VII, 2-4; two sometimes on a pale brown sclerite with spinulose imbrications; length of hairs on tergite IV, 35-60  $\mu$ , ventrally on IV, 23-55  $\mu$ . Tergite VIII with a transversely elongate pale brown plate, e.g. 300  $\mu$  wide, and 98  $\mu$  long, the anterior side rounded, the posterior margin almost straight, with spinulose imbrications, and 5-7 hairs, 45-65  $\mu$  long; spinally 8-14 wax glands in an oval group, e.g. 172  $\mu$  wide, and 88  $\mu$  long, the glands with a diameter of 30-50  $\mu$ . Star-shaped and s-shaped wax glands on the colourless parts of the body are rather indistinct. Siphunculi located dorsally on segment V, pale brown, but usually darker than the sclerites with wax glands, with some concentrically arranged rather smooth imbrications, at the base 98-126  $\mu$  wide, the cone without hairs, but outside the cone about four hairs; pore brown, elevated above the base 20-38  $\mu$ , the margin of the pore about 50-110  $\mu$  from the margin of the abdomen, diameter of the pore 48-70  $\mu$ . Cauda transversely elongate e.g. 156  $\mu$  wide at the base (but usually not well-defined), the knob 123  $\mu$  wide, the length of the knob 55  $\mu$ , and diameter of the constriction 50  $\mu$ ; the knob 93-134  $\mu$  wide, with 14-23 hairs, the longest 69-96  $\mu$ . Subanal plate bilobed, with 17-22 hairs, the longest 83-111  $\mu$ . Subgenital plate with 4-5 anterior hairs, 49-71  $\mu$  long, and 11-17 posterior hairs, 40-59  $\mu$  long. Gonapophyses two, each with 5-9 hairs, the longest 8-14  $\mu$ .

Alate viviparous female.— In life: Head and thorax black, abdomen dull brown. Eyes black. Antennae black. Legs greyish black. Siphunculi and cauda dark brown. Pterostigma of the fore wing greyish black (Van der Goot, 1917).

Macerated specimens.— (figs. 398-403; described from three fragmentary specimens, some data from Van der Goot, 1917). Body length 2.37-2.60 mm, 2.0-2.4 times as long as it is wide.

Head.— (fig. 398). Head brown, dorsally with blunt spinulae of about one  $\mu$  diameter, anterior to the paired ocelli with concentric wrinkles; width across the eyes 460-510  $\mu$ , in the area dorsal to the horns to between the paired ocelli 5-7 hairs, the longest 15-18  $\mu$ , posterior to the paired ocelli 4-6 hairs. Frons with two horns with rounded tips, 5-20  $\mu$  long, with about 14 hairs on the horn and near the base, 4-6  $\mu$  long. Ventrally posterior to the median ocellus, 7-9 hairs on each side. Antennae brown, with black rings, with five segments 810-1080  $\mu$  long, 0.34-0.41 times as long as the body, and 1.8 times the width of the head across the eyes; segment I somewhat wrinkled, segment II with some longitudinal wrinkles, and dorsally and ventrally with spinulose imbrications, the spinulae 2-3  $\mu$  long; segments III-V (fig. 399) with ring-shaped secondary rhinaria, the rings are not closed on the dorsal side, with a space of 2-30  $\mu$ ; between the rhinaria are 4-5 concentric spinulose imbrications, dorsally and ventrally with interconnections; the rhinaria are 2-3  $\mu$  wide. The primary rhinaria are between the annular rhinaria and moulded with them to a complex structure; segment III with 24-30 annular rhinaria, IV with 6-10, V with 8-11; hairs of segment III, 8-15  $\mu$  long. Length of segment III, 354-432  $\mu$ , 2.4-2.9 times as long as IV, 2.0-2.5 as V, and 1.1-1.3 times as IV plus V; segment IV, 125-151  $\mu$  long, 0.8-0.9 times as long as V; V, 153-181  $\mu$  long, the processus terminalis 16-22  $\mu$ . The last rostral segment is 82-88  $\mu$  long, 0.58-0.64 times as long as the second tarsal segment of the hind leg, without accessory hairs; length of the stylets 275-335  $\mu$ . Eyes compound, the ocular tubercle extending sideways about 25  $\mu$ .

Thorax.— Sides of the prothorax pale brown, the mesothorax brown. Fore wing (fig. 400) medial vein once branched, the hind wing with two oblique veins. Legs almost evenly brown, smooth, but the second tarsal segments with some spinulose imbrications; the tibia of the fore leg 560-590  $\mu$  long, 1.10-1.28 times as long as the width of the head across the eyes, length of the hairs of the hind tibia 37-50  $\mu$ ; chaetotaxy of first tarsal segments 4, 4, 2, the lateral hairs of the fore tarsus 1.5-2.1 times as long as the middle; length of the hairs of the first tarsal segment of the hind leg 29-33  $\mu$ ; the dorsoapical hairs of the second tarsal segment of the hind leg (fig. 401) without expanded tips, acute, 27-35  $\mu$  long; length of the empodial hair of the hind leg 37-45  $\mu$ . Length of the hind segments: femur fused with trochanter 496-518  $\mu$ , tibia 720-771  $\mu$ , 1.4-1.5 times as long as the femur, and 1.4-1.7 times the width of the head across the eyes; first tarsal segment 42-45  $\mu$  long, second tarsal segment 137-141  $\mu$ .

Abdomen.— (fig. 402). Abdominal segments I-VI colourless, VII margins and dorsum with one pale brown plate with spinulose imbrications; VIII pale brown, with a curved anterior margin, and an almost straight posterior margin, pleurally with a denticle 8-10  $\mu$  high, with spinulose imbrications; number of hairs on tergite VIII, 6-8, 25-38  $\mu$  long. Siphunculi (fig. 403) located on tergite V, a brown cone about 15  $\mu$  high, the pore 31-33  $\mu$  wide, and the base 37-43  $\mu$ , from above almost observed as a brown ring, without hairs. Cauda transversely elongate, e.g. 160  $\mu$  wide at the base, the knob 90  $\mu$  wide, 41  $\mu$  long, and diameter of the constriction 50  $\mu$ ; the knob is 76-90  $\mu$  wide, with 19-22 hairs, the longest 37-53  $\mu$ . Subanal plate bilobed, with 16-20 hairs, the longest 49-55  $\mu$ . Subgenital plate with 10-19 hairs on the plate, the longest 40-50  $\mu$ , and 13-17 along the posterior margin, the longest 35-45  $\mu$ . Gonapophyses two, each with 9-11 hairs, the longest 18-22  $\mu$ . Spiracles on six abdominal segments, II-VII.

First stage larvae of apterous viviparous females exist as the type which develops into adult specimens, and as a "soldier" type which does not develop into later stages. The soldier type is only lacking in one out of seven populations from which specimens were collected. A description of both types is given below.

First stage larva of apterous viviparous female (fig. 404; description of one specimen). Body length 790  $\mu$ , length of head plus pronotum 246  $\mu$ , width of prothorax 272  $\mu$ , width of the head across the eyes 236  $\mu$ ; the head dorsally, and dorsally to the horns with seven anterior hairs, and two rows each of four hairs between the eyes, about 45  $\mu$  long. Antennae with four segments, 205  $\mu$  long, segment III smooth, 65  $\mu$  long, IV with smooth imbrications, 81  $\mu$  long; length of hairs on segment II, 27  $\mu$ , on III, 20  $\mu$ . Frons with two horns, pointed, smooth, 76  $\mu$  long, and 33  $\mu$  wide at the base, with hairs 4-6  $\mu$  long. Fore legs normal, the femur 216  $\mu$  long, and 50  $\mu$  wide in the middle, 0.91 times as long as the width of the head across the eyes; tibia of the fore leg not curved at the basal part, 236  $\mu$  long; length of distal hairs of the hind tibia 61  $\mu$ . All first tarsal segments with two hairs, about 88  $\mu$  long. Two dorsoapical hairs of the second tarsal segments of the hind leg with expanded tips, 80  $\mu$  long, the other apical hairs smaller and acute. Medial to the eyes on each side a group of wax glands, marginal wax gland groups on the thoracic segments and abdominal segments I-VII, and a pair of spinal groups of wax glands on each of the thoracic and abdominal segments I-VI; spinal wax glands lacking on abdominal segment VII, and on segment VIII one group, 45  $\mu$  wide (35-55  $\mu$ , always wider than in *P. bambusicola*), and about 22  $\mu$  long; borders of the wax glands in the groups usually indistinct.

Abdominal segments dorsal to the marginal wax glands with one hair, tergites I-V with four hairs, VI-VIII with two, on VIII, 40  $\mu$  long. Cauda with two hairs, 43  $\mu$  long. Siphunculi absent.

First stage larva "soldier" (fig. 405; description of one specimen). Body length 1025  $\mu$ , length of head plus pronotum 322  $\mu$ , 0.94 times the width of the prothorax, width of the head across the eyes 306  $\mu$ ; the head dorsally with 5-7 anterior hairs, and between the eyes an anterior and a posterior row, each of four hairs, about 30  $\mu$  long; ventrally on each side four hairs, the longest 90  $\mu$  long. Antennae with four segments, 306  $\mu$  long, segment III, 120  $\mu$  with a few smooth imbrications, IV with smooth imbrications, 112  $\mu$  long, length of hairs on segments II and III about 32  $\mu$ . Frons with two horns, pointed, smooth, 157  $\mu$  long, and 82  $\mu$  wide at the base, with hairs 2-10  $\mu$  long. Fore legs darker brown, more sclerotic and more sturdy than the other legs; femur of the fore leg 464  $\mu$  long, and 147  $\mu$  wide in the middle, 1.52 times as long as the width of the head across the eyes; tibia of the fore leg curved at the basal part, 456  $\mu$  long; length of distal hairs of the hind tibia 98  $\mu$ . All first tarsal segments with two hairs, of the hind leg 108  $\mu$  long; diameter of the base of the first tarsal segment of the fore leg 57  $\mu$ , 1.8 times as wide as that of the hind leg. Two dorsoapical hairs of the second tarsal segment of the hind leg with expanded tips, 118  $\mu$  long, the other apical hairs smaller and acute. Wax gland groups lacking on the head and the prothorax, but on most of the other segments present; star-shaped wax glands, frequently observable as ovals on all sclerotic parts of the body. Abdominal segments dorsal to the marginal wax glands with one hair, tergites I-V with four hairs, VI-VIII with two, on VIII, 50  $\mu$  long. Cauda with two hairs, 63  $\mu$  long. Siphunculi absent.

Embryos inside alatae are similar to those of apterae, with horns.

Host plant records.— Specimens were collected in Java on bamboo, in the places, and on the dates indicated, while the collectors are indicated by numbers between parentheses: P. van der Goot or Van der Goot (1917), (1), partly in the collection at the Laboratorium voor Entomologie, Wageningen; D. Noordam (2), in the collection at the Rijksmuseum van Natuurlijke Historie, Leiden. Dessa Sidadap, Mt. Merbaboe (1300 m), vii.1915; Mt. Dieng (1000-2000 m) (1); Lembang, 2.viii.1918, 8.ii.1932 (1); Sindanglaya (1100 m), 29.iv.1975, 28.vii.1975, 21.x.1975 (2); Dieng (2000 m), 2.i.1977 (2); Sindanglaya, 15.xi.1977 (2).

The aphids of small populations live on the lower side of the base of leaves, extremely densely crowded, and also on the tip of the shoot with rolled-in leaves. Large populations are spread over the lower sides of all leaves of shoots, and also over the shoots, while all parts below the populations are black, covered with sooty moulds.

Alatae were collected xi.1915, and 2.viii.1918.

Etymology.— Montana, pertaining to mountains, name given to this species by Van der Goot (1917).

***Pseudoregma nicolaiae* (Takahashi, 1935)**  
(figs. 406-408)

*Oregma nicolaiae* Takahashi, 1935: 6.

*Pseudoregma nicolaiae*; Eastop & Hille Ris Lambers, 1976: 366.

Takahashi (1935) described this species from specimens collected from *Nicolaia speciosa* (Bl.) Horan, and Takahashi (1941) mentions that *P. nicolaiiae* has longer dorsal setae than *P. sundanica* (Van der Goot, 1917). A description of the species with characteristics of specimens from the only collection from Java follows.

Apterous viviparous female.— In life: Body brownish black. Head brown. Antennae pale brown, the last segment grey. Legs pale brown, the tarsi grey. Siphunculi black. Cauda pale brown. The body with a waxy whitish powdery secretion, a marginal row of columns of wax, and two spinal rows. Larvae pale brown.

Macerated specimens.— (figs. 406-407; described from five specimens): Body 1.58-1.79 mm long, 1.5-1.7 times as long as it is wide.

Head.— Head pale brown or brown, with pustules having an irregular, more or less star-shaped outline, with dotted surface, and a diameter of 6-14  $\mu$ ; frons not protruding in the middle, head across the eyes 421-465  $\mu$  wide. Horns tapering to the end, the tips rounded, with 10-12 hairs, 2-10  $\mu$  long, one basal hair sometimes up to 14  $\mu$ ; length of horns 43-60  $\mu$ , 0.10-0.13 times as long as the width of the head across the eyes. Head dorsally with 4-7 anterior hairs, and between the eyes an anterior row of four hairs, and a posterior row of 4-5, 69-78  $\mu$  long. Wax glands medial to the eyes on each side, in an oval group with a diameter of 30-90  $\mu$ , 2-12 glands, squeezed flat against each other, the outer border sometimes partly thickened, but between the glands only colourless lines; the glands with facets, 1-2  $\mu$  wide. Antennae with four segments, pale brown, the last segment slightly darker, 350-395  $\mu$  long, 0.22-0.23 times as long as the body, 0.78-0.90 times the width of the head across the eyes, and 0.79-0.91 times as long as the tibia of the fore leg; the segments with some smooth imbrications or wrinkles. Segment III, 150-172  $\mu$  long, 1.3-1.5 times as long as IV, with 6-8 hairs, 30-43  $\mu$  long; segment IV, 108-115  $\mu$  long, the processus terminalis 36-38  $\mu$  long, with two hairs, and five apical setae, 14-16  $\mu$  long. Eyes darker brown than the head, with three ommatidia. Ultimate rostral segment 110-118  $\mu$  long, 0.85-0.96 times as long as the second tarsal segment of the hind leg; stylets 480-500  $\mu$  long.

Thorax.— Prothorax the same colour as the head, with more distinct pustules than on the head, fused with the head; pleurally a groove is observable, passing from the posterior margin to a large muscular plate anteriorly, 20-30  $\mu$  deep in relation to the elongate-oval swelling on each side of the median line; these swellings fall sharply at these grooves, on the anterior and posterior sides and at the median groove; the pustules on these swellings are numerous sometimes with thickened margins, and with a dotted surface observable at a magnification of 400; on each side two marginal hairs, dorsally zero anterior hairs, and 2-5 posterior; posteromarginally 3-6 wax glands on each side in an oval group, and spinally two groups of 6-11 wax glands. Mesothorax marginal and dorsal sclerites united, pale brown, with pustules with an irregular border, the surface of which sometimes with facets with a diameter of 3-5  $\mu$ , with a median groove, and a pleural longitudinal groove with a muscular plate; marginally with an oval group with 2-9 faceted wax glands, and two spinal groups with 0-8 glands; dorsally with seven hairs. Metathorax sclerites united or with two marginal and four dorsal sclerites, marginally with an oval group of 2-7 wax glands, and spinally two groups with 3-6 glands; dorsally with 4-10 hairs. Legs almost evenly pale brown, or the tibiae distally slightly paler, the second tarsal segment with some smooth imbrications and some spinulae, other parts of the legs almost smooth. Tibia of the fore leg 417-460  $\mu$  long, 0.98-0.99 times as long as the

width of the head across the eyes. First tarsal segments of the fore leg with four hairs, the lateral 2.3-3.0 times as long as the middle hairs, of the midleg usually with four, and sometimes with three hairs, of the hind leg with two hairs, 41-47  $\mu$  long. Second tarsal segments of the hind leg 0.17-0.18 times as long as the tibia of the hind leg, and 0.28-0.30 times as long as the width of the head across the eyes, with one dorsoapical hair expanded at the tip, 71-76  $\mu$  long, the tip 2-3  $\mu$  wide, the other dorsoapical hair of about the same length, but acute. Empodial hairs of the hind leg 37-41  $\mu$  long. Length of the segments of the hind leg: femur plus trochanter 488-519  $\mu$ , tibia 677-771  $\mu$ , 1.39-1.48 times as long as the femur, and 1.61-1.66 times the width of the head across the eyes, first tarsal segment 40-45  $\mu$ , second tarsal segment 123-126  $\mu$ .

Abdominal segments I-VII very pale brown, and segments I-III or IV, more than in *P. sundanica* and *P. pendleburyi*, with colourless parts along the borders of the segments and around the pleural sclerites; segments IV-VII with only narrow colourless segmental borders. Star-shaped wax glands (fig. 407) with a diameter of 8-20  $\mu$  dorsally on pale brown and colourless parts, with a surface with facets, 2-6  $\mu$  in diameter; ventrally are s-shaped wax glands. Marginal sclerites with oval groups of wax glands, 110-165  $\mu$  wide, the glands with a diameter of 20-60  $\mu$ ; the glands number on segment I, 6-9; II, 5-12; III, 6-15; IV, 5-14; V, 5-10; VI, 6-10; VII, 4-7. Spinally a pair of wax gland groups, numbers on segment I, 1-5; II, 1-6; III, 2-6; IV, 0-7; V, 0-6; VI, 0-4, and are lacking on VII. Tergite I with 6-10 hairs; II with 6-11; III, 7-9; IV, 7-10; V between the siphunculi 5-8, or up to 12, if the hairs medial to the siphunculi are included; VI, 2-3; VII, 2-3; length of the hairs on tergite IV, 60-76  $\mu$ , ventrally on IV, 40-55  $\mu$ . Tergite VIII with a transversely elongate pale brown plate, e.g. 300  $\mu$  wide, and 100  $\mu$  long, the anterior side rounded, the posterior margin almost straight, with spinulose imbrications, and 7-9 hairs, 80-96  $\mu$  long; spinally seven specimens without wax glands, but in one specimen only one gland, 37  $\mu$  wide and 25  $\mu$  long. Siphunculi located dorsally on segment V, with some concentrically arranged imbrications and some fine spinulae, at the base 165-205  $\mu$  wide, but no distinct border in respect to the surroundings, with 5-6 hairs; pore brown, elevated 25-30  $\mu$  above the base, the margin of the pore about 60-75  $\mu$  from the margin of the abdomen, diameter of the pore 51-55  $\mu$ . Cauda transversely elongate, e.g. 115  $\mu$  wide at the base, the knob 100  $\mu$  wide, the length of the knob 41  $\mu$ , and diameter of the constriction 69  $\mu$ ; the knob 86-104  $\mu$  wide, with 11-13 hairs, the longest 86-98  $\mu$ . Subanal plate bilobed, with 20-24 hairs, the longest 88-98  $\mu$ . Subgenital plate with four anterior hairs, 45-61  $\mu$  long, and 11-14 posterior hairs, 41-60  $\mu$  long. Gonapophyses two, each with 6-10 hairs, the longest 12-20  $\mu$ .

First stage normal larva of apterous viviparous female (fig. 408; description of one specimen).

Body length 855  $\mu$ , length of head plus pronotum 283  $\mu$ , 0.80 times the width of the prothorax; width of the head across the eyes 287  $\mu$ , the head dorsally and dorsal to the horns with five hairs, and two rows each of four hairs between the eyes, 78  $\mu$  long. Antennae with four segments, 315  $\mu$  long, segment III dorsally smooth, ventrally with some smooth imbrications, 120  $\mu$  long, IV with smooth imbrications, 116  $\mu$  long, with the processus terminalis 45  $\mu$  long; length of hair on segment II, 40  $\mu$ ; on III, 53  $\mu$ . Frons with two horns, pointed, smooth, 118  $\mu$  long, and 43  $\mu$  wide at the base, with hairs 4-8  $\mu$  long, and one hair basally 67  $\mu$  long. Fore leg normal, the femur 318  $\mu$  long, and 67  $\mu$  wide in the middle, 1.11 times as long as the width of the head

across the eyes; tibia of the fore leg not curved at the basal part, 368  $\mu$  long; length of distal hairs of the hind tibia 72  $\mu$ . All first tarsal segments with two hairs, of the hind leg 84  $\mu$  long. Two dorsoapical hairs of the second tarsal segment of the hind leg with expanded tips, 80  $\mu$  long, the other apical hairs 60  $\mu$  long, thinner and almost acute. Medial to the eyes on each side a group of wax glands, marginal wax gland groups on the thoracic segments and abdominal segments I-VII, and a pair of spinal wax gland groups on each of the thoracic segments and abdominal segments I-VI; spinal wax glands lacking on abdominal segments VII and VIII. Marginal and dorsal thoracic and abdominal sclerites very pale brown, with the wax gland groups, pustules and hairs; abdominal segments dorsal to the marginal wax glands with one hair; tergites I-IV with four hairs, V-VIII with two, on VIII, 78  $\mu$  long. Cauda with two hairs, 60  $\mu$  long. Siphunculi absent.

Host plant records.— Specimens were collected in Java on *Hedygium coccineum* Buch.-Ham., Hort. Bot. Cibodas, 15.ii.1976, leg. D. Noordam, in the collection at the Rijksmuseum van Natuurlijke Historie, Leiden.

The aphids live on the lower side of the leaf, on the vein.

Alatae were not collected.

Etymology.— *Nicolaia*, from *Nicolaia*, name given to this species by Takahashi (1935), who made the description of this species after specimens collected in Sumatra by M. J.C. van der Meer Mohr from *Nicolaia speciosa* (Bl.) Horan.

***Pseudoregma panicola* (Takahashi, 1921)**  
(figs. 409-420)

*Oregma panicola* Takahashi, 1921: 90.

*Pseudoregma panicola*; Eastop & Hille Ris Lambers, 1976: 366.

Apterous viviparous female.— In life (pl. 41). Brownish black, blackish brown or (Dr W.F. Rappard, unpublished) violet brownish red. Eyes black. Antennae black or pale brown. Legs pale brown or colourless. Cauda pale brown or blackish. The body evenly covered with a white granular layer of wax, or rows of short or long columns of dense white wax are present in one marginal and two spinal lines, while granular wax is present everywhere between the columns.

Macerated specimens.— (figs. 409-411; described from 11 specimens). Body 1.08-1.87 mm long, 1.4-1.8 times as long as it is wide.

Head.— Head pale brown or brown, with some pustules having an irregular, more or less star-shaped outline, with dotted surface, and a diameter of 6-10  $\mu$ ; frons not protruding in the middle, head across the eyes 295-420  $\mu$  wide. Horns (fig. 410) slightly tapering to the ends, the tips rounded, with 6-8 hairs, 2-4  $\mu$  long at the tip, but at the base sometimes longer; length of horns 20-47  $\mu$ , 0.07-0.13 times as long as the width of the head across the eyes. Head dorsally with 5-9 anterior hairs, and between the eyes an anterior and a posterior row, each with four hairs, 43-63  $\mu$  long. Wax glands medial to the eyes are usually lacking, but sometimes up to seven glands are present on each side, arranged in an oval group and squeezed flat against each other. Antennae with four or five segments, pale brown or brown, the last segment slightly darker, 170-330  $\mu$  long, 0.13-0.19 times as long as the body, 0.54-0.88 times the



width of the head across the eyes, and 0.74-1.00 times as long as the tibia of the fore leg; the segments smooth or with smooth imbrications or wrinkles. In four-segmented antennae III, 50-100  $\mu$  long, 0.7-1.0 times as long as IV, with 3-4 hairs, 16-30  $\mu$  long; segment IV, 55-98  $\mu$  long, the processus terminalis 22-34  $\mu$  long, with two hairs, and five apical setae. In five-segmented antennae III, 70-90  $\mu$  long, 1.7-1.8 times as long as IV, 0.74-0.82 times as long as V, with 2-3 hairs; IV, 40-49  $\mu$  long, 0.42-0.44 times as long as V, with three hairs; V, 95-110  $\mu$  long, the processus terminalis 33-35  $\mu$  long, with two hairs and five apical setae. Eyes darker brown than the head, with three ommatidia. Ultimate rostral segment 55-71  $\mu$  long, 0.54-0.70 times as long as the second tarsal segment of the hind leg; stylets 230-295  $\mu$  long.

Thorax.— Prothorax (figs. 409, 411) the same colour as the head, with more distinct pustules than on the head, fused with the head, pleurally a groove is observable passing from the posterior margin to a large muscular plate anteriorly, about 25  $\mu$  deep in relation to the elongate-oval swelling on each side of the median line; the swellings fall sharply at these grooves, on the anterior and posterior sides, and at the median groove; the pustules on these swellings are numerous, with thickened margins, oval or quadrangular, with a dotted surface observable at a magnification of 400; on each side two marginal hairs, zero anterior, and 2-4 posterior dorsal hairs; posteromarginally 0-8 wax glands on each side in an oval group, and spinally two groups of 0-4 wax glands. Mesothorax with a large marginal sclerite, pale brown or brown, with 0-8 oval, faceted, wax glands, with or without interspaces, the space outside these glands occupied by star-shaped dotted pustules; dorsally a pair of elongate oval plates with 0-8 wax glands, the spaces outside the wax glands occupied by star-shaped pustules, dorsally 4-6 hairs. Metathorax marginally with a pale brown sclerite, smaller than on the mesothorax, with 0-5 faceted wax glands or these replaced by star-shaped dotted pustules, dorsally a pair of small elongate oval, pale brown plates with 0-5 wax glands, or these are replaced by star-shaped pustules, dorsally 4-8 hairs. Legs almost evenly pale brown or brown, but the second tarsal segments with smooth imbrications and on the plantar side a few spinulae. Tibia of the fore leg 195-326  $\mu$  long, 0.61-0.82 times as long as the width of the head across the eyes. First tarsal segments of fore- and midleg with 3-4 hairs, the lateral hairs 2.0-2.9 times as long as the middle hairs, the segments of the hind leg with two hairs, 40-53  $\mu$  long; second tarsal segments of the hind leg 0.25-0.29 times as long as the tibia of the hind leg, and 0.25-0.32 times as long as the width of the head across the eyes, with two dorsoapical hairs expanded at the tips, 47-67  $\mu$  long, the tips 2-3  $\mu$  wide. Empodial hairs of the hind leg 27-37  $\mu$  long. Length of the segments of the hind leg: femur plus trochanter 232-381  $\mu$ , tibia 295-496  $\mu$ , 1.17-1.35 times as long as the femur, and 0.88-1.27 times the width of the head across the eyes, first tarsal segment 25-37  $\mu$ , second tarsal segment 81-128  $\mu$ .

Abdomen.— Abdominal segments I-VII with colourless or pale brown, oval, marginal sclerites with a diameter on segment I of e.g. 70  $\mu$ , and 100  $\mu$  on segment VII; the sclerites with oval faceted wax glands, 20-35  $\mu$  diameter arranged in an oval group; in populations with alatae the glands are sometimes smaller and disappear, but on segment VII wax glands are always present; where wax glands are lacking, they are replaced by star-shaped pustules; the wax glands on the marginal segments number: I, 0-4; II, 0-6; III, 0-5; IV, 0-4; V, 0-5; VI, 0-5; VII, 3-6. The tergites are colourless or on the anterior segments sometimes with a pair of very pale brown sclerites

bearing wax glands or sometimes some star-shaped pustules; wax glands may be present on each pair of sclerites on the segments, but are more often lacking than on the marginal sclerites, they number on each spinal sclerite: I, 0-5; II, 0-4; III, 0-5; IV, 0-3; V, 0-4; VI, 0-3, but usually 0; VII absent or rarely one on one sclerite only. The tergite I with 5-9 hairs; II, 4-8; III, 5-8; IV, 4-12; V, 2-8; VI, 2-6; VII two; length of hairs on tergite IV, 43-60  $\mu$ , ventrally on IV the longest hairs 27-47  $\mu$ . Tergite VIII with a transversely elongate pale brown plate, e.g. 210  $\mu$  wide, and 67  $\mu$  long, the anterior side rounded, the posterior margin almost straight, with spinulose imbrications, and 4-7 hairs, 50-73  $\mu$  long; spinally with 5-9, or rarely three wax glands in an oval group, e.g. 137  $\mu$  wide, and 40  $\mu$  long, the glands with a diameter of 20-40  $\mu$ . S-shaped wax glands are distinct on the marginal and ventral parts of the body. Siphunculi located dorsally on segment V, pale brown, with some concentrically arranged, smooth imbrications, at the base 53-74  $\mu$  wide, the cone without hairs, but outside the cone 2-3 hairs; pore brown, elevated above the base 15-25  $\mu$ , the margin of the pore about 70-110  $\mu$  from the margin of the abdomen, diameter of the pore 29-45  $\mu$ . Cauda transversely elongate, the base usually difficult to distinguish, the knob e.g. 92  $\mu$  wide, the length of the knob 51  $\mu$ , diameter of the constriction 45  $\mu$ ; the knob 55-98  $\mu$  wide, with 9-14 hairs, the longest 57-83  $\mu$ . Subanal plate bilobed, with 11-15 hairs, the longest 55-92  $\mu$ . Subgenital plate with 3-6 anterior hairs, 31-57  $\mu$  long, and 7-11 posterior hairs, 35-63  $\mu$  long. Gonapophyses two, each with 1-6 hairs, the longest 8-12  $\mu$ .

Alate viviparous female.— In life: Black, with or without some dusting of wax (Dr F.W. Rappard, unpublished), pterostigma of fore wings greyish black (Van der Goot, unpublished).

Macerated specimens.— (figs. 412-418; described from nine specimens). Body length 1.73-2.26 mm, 1.8-2.4 times as long as it is wide.

Head (figs. 412-414).— Head black, dorsally with blunt spinulae of about one  $\mu$  diameter, anterior and medial to the paired ocelli with some concentric wrinkles; width of the head across the eyes 381-455  $\mu$ , on the head dorsal to the horns 12-14 hairs, 14-23  $\mu$  long. Frons with two horns with rounded tips, 4-16  $\mu$  long, with 5-7 hairs, 4-6  $\mu$  long, or horns absent and only an area with short hairs. Ventrally posterior to the median ocellus, 8-12 hairs on each side. Antennae black, with five segments, 665-770  $\mu$  long, 0.32-0.42 times as long as the body, and 1.6-2.0 times the width of the head across the eyes; segment I somewhat wrinkled, segment II with some longitudinal wrinkles, and dorsally and ventrally with spinulose imbrications, the spinulae 2-4  $\mu$  long; segment III-V (fig. 413) with ring-shaped secondary rhinaria, the rings are not closed on the dorsal side, with a space of 2-35  $\mu$ ; between the rhinaria are 3-5, or on the last segment more, concentric spinulose imbrications, dorsally and ventrally with interconnections; the rhinaria are 3-4  $\mu$  wide. The primary rhinaria are between the annular rhinaria and moulded with them to a complex structure; segment III with 16-24 annular rhinaria, IV with 6-9, V with 6-11 or (Van der Goot unpublished) four only; hairs on segment III, 10-18  $\mu$  long. Length of segment III, 295-380  $\mu$ , 2.5-3.2 times as long as IV, 1.8-2.7 times as long as V, and 1.0-1.4 times as long as IV plus V; segment IV, 120-135  $\mu$  long, 0.7-0.9 times as long as V; V, 137-180  $\mu$  long, the process terminalis 16-38  $\mu$ . The last rostral segment (fig. 414) is 73-80  $\mu$  long, 0.58-0.63 times as long as the second tarsal segment of the hind leg, without accessory hairs; length of the stylets 244-305  $\mu$ . Eyes compound, the ocular tubercle extending sideways 23-27  $\mu$ .

Thorax.— Sides and dorsum of the prothorax brown or pale brown, the mesothorax black. Fore wing (fig. 415) medial vein once branched, the hind wing with two oblique veins. Legs black, the distal end of the femur and the basal part of the tibia slightly darker, the femora of the fore leg with some spinulae, all second tarsal segments with spinulose imbrications. The tibia of the fore leg 488-550  $\mu$  long, 1.14-1.24 times as long as the width of the head across the eyes, length of distal hairs of the hind tibia 35-53  $\mu$ ; chaetotaxy of first tarsal segments 4, 3-4, 2, the lateral hairs of the fore tarsus 1.7-2.5 times as long as the middle; length of hairs of first tarsal segments of the hind leg 23-43  $\mu$ ; second tarsal segment of the hind leg (fig. 416) with one dorsoapical hair with expanded tip, 45-63  $\mu$  long, the tip three  $\mu$  wide; length of the empodial hair of the hind leg 27-39  $\mu$ . Length of the hind segments: femur fused with the trochanter 488-500  $\mu$ ; tibia 669-724, 1.4-1.5 times as long as the femur, and 1.5-1.6 times the width of the head across the eyes; first tarsal segment 35-40  $\mu$  long, second tarsal segment 121-134  $\mu$ .

Abdomen (fig. 417).— Abdominal segments I-V colourless, VI colourless, but sometimes with a pair of pale brown, oval sclerites, with some spinulose imbrications; VII margins and dorsum with one pale brown plate with spinulose imbrications; VIII pale brown, colourless along the borders, emarginate at the posterior margin 10-35  $\mu$ , usually pleurally with a denticle 4-6  $\mu$  high, with spinulose imbrications; number of hairs on tergites II-V about 2-6; on IV, 15-22  $\mu$  long; on tergite VI, 2-5 hairs; on VII, 3-5, on VIII, 5-10, 37-45  $\mu$  long. Siphunculi (fig. 418) located on tergite V, colourless or at one side outside the pore 4-10  $\mu$  pale brown with blunt spinulae, and in one specimen a pale brown sclerite extending backwards 40  $\mu$ , in the surroundings of the siphunculi 3-5 hairs; the pore yellowish brown, about 10  $\mu$  above the surroundings, diameter of the pore 30-38  $\mu$ . Cauda transversely elongate, the base sometimes not well-defined, e.g. 120  $\mu$  wide, the knob 76  $\mu$  wide, 45  $\mu$  long, and diameter of the constriction 37  $\mu$ ; the knob is 61-83  $\mu$  wide, with 13-15 hairs, the longest 45-61  $\mu$ . Subanal plate bilobed, with 15-18 hairs, the longest 50-68  $\mu$ . Subgenital plate with 8-11 hairs on the plate, the longest 35-45  $\mu$ , and 9-16 hairs along the posterior margin, the longest 40-57  $\mu$ . Gonapophyses two, each with 5-8 hairs, the longest 14-20  $\mu$ . Spiracles on six abdominal segments, II-VII.

First stage larvae of apterous viviparous females exist as the type which develops into adult specimens, and into a "soldier" type, which does not develop into later stages. The soldier type occurs only in older populations. A description of both types follows below.

First stage larva of apterous viviparous female (fig. 419; description of one specimen): Body length 585  $\mu$  (435-850  $\mu$ ), length of head plus pronotum 198  $\mu$ , width of prothorax 261  $\mu$ , width of the head across the eyes 215  $\mu$ ; the head dorsally with six anterior hairs, and two rows each of four hairs between the eyes, 40-60  $\mu$  long; medial to the eyes on each side a group of four wax glands, the borders of which are distinct only at the outer outline. Antennae with four segments, 159  $\mu$  long, segment III dorsally smooth, 43  $\mu$  long, IV with smooth imbrications, 74  $\mu$  long; length of hair on segment II, 30  $\mu$ , and on III, 35  $\mu$ . Frons with two horns, pointed, smooth, 53  $\mu$  long, and 25  $\mu$  wide at the base, with hairs 2-4  $\mu$  long. Fore legs normal, the femur 155  $\mu$  long, and 37  $\mu$  wide in the middle, 0.72 times as long as the width of the head across the eyes; tibia of the fore leg not curved at the basal part, 170  $\mu$  long; length of distal hairs of the hind tibia 60  $\mu$ . All first tarsal segments with two hairs, about 65  $\mu$  long.

Two dorsoapical hairs of the second tarsal segment of the hind leg with expanded tips, 60  $\mu$  long, the other apical hairs smaller and acute. Marginal and spinal wax gland groups on the thoracic segments and abdominal segments I-V, but on segments VI and VII marginal wax gland groups only; segment VIII with one group of wax glands, 43  $\mu$  wide, and about 15  $\mu$  long. Abdominal segments dorsal to the marginal wax glands with one hair, tergites I-IV with four hairs, V-VIII with two, on VIII, 33  $\mu$  long. Cauda with two hairs, 29  $\mu$  long. Siphunculi absent.

First stage larva, "soldier" (fig. 420; description of one specimen). Body length 910  $\mu$ , length of head plus pronotum 299  $\mu$ , 0.88 times the width of the prothorax; width of the head across the eyes 295  $\mu$ ; the head dorsally with eight anterior hairs and between the eyes an anterior and posterior row each with four hairs, the spinal hairs of the posterior row far back, about 60  $\mu$  long; ventrally on each side three hairs, the longest 100  $\mu$ . Antennae with four segments, 257  $\mu$  long, segment III, 98  $\mu$ , with smooth imbrications, IV with smooth imbrications, 100  $\mu$  long, length of hair on segment II, 37  $\mu$ ; on III, 45-50  $\mu$ . Frons with two horns, pointed, smooth, 145  $\mu$  long, and 90  $\mu$  wide at the base, with hairs not more than four  $\mu$  long. Fore legs more sclerotic and more sturdy than the other legs; femur of the fore leg 354  $\mu$  long, and 119  $\mu$  wide in the middle, 1.20 times as long as the width of the head across the eyes; tibia of the fore leg curved at the basal part, 338  $\mu$  long; distal hairs of the hind tibia 112  $\mu$  long. All first tarsal segments with two hairs, of the hind leg 85  $\mu$  long; diameter of the base of the first tarsal segment of the fore leg 41  $\mu$ , 1.6 times as wide as that of the hind leg. Two dorsoapical hairs of the second tarsal segment of the hind leg with expanded tips, 102  $\mu$  long, the other apical hairs smaller and acute. Marginal wax gland groups present on the thoracic segments and abdominal segments I-III, spinal wax glands on abdominal segment VIII only. Tergites I-V with four hairs, VI-VIII with two, on VIII, 67  $\mu$  long. Cauda with two hairs, 50  $\mu$  long. Siphunculi absent.

Embryos inside alatae are similar to those of apterae, with horns, but in one collection embryos have blunt hairs, 18-35  $\mu$  long, and lack horns and wax gland groups.

Host plant records— Specimens were collected in Java on the plants, in the places, and on the dates indicated, while the collectors are indicated by numbers between parentheses: P. van der Goot (unpublished manuscript), (1), partly in the collection at the Laboratorium voor Entomologie, Wageningen; F.W. Rappard (2), in the collection at the British Museum (Natural History), London; and D. Noordam (3), in the collection at the Rijksmuseum van Natuurlijke Historie, Leiden. *Oplismenus compositus* (L.) Beauv., Merbaboe (1000 m), 10.v.1916 (1); grass, Merbaboe, vi.1916 (1); grass, Tjisoeroepan-Garoet (1400 m), 23.viii.1916 (1); *Oplismenus compositus* (L.) Beauv., Pasewaran-Banjoewangi (500 m), 2.v.1950 (2); *Oplismenus compositus* (L.) Beauv., Gondang, Mt. Yang (500 m), 20.v.1950 (2); Soember Klopo-Mt. Yang (300 m), 8.vii.1950 (2); *Oplismenus compositus* (L.) Beauv., Bondowoso (300 m), 18.vii.1950 (2); *Oplismenus compositus* (L.) Beauv., Soember-Balen (750 m), 28.vii.1950 (2); *Oplismenus compositus* (L.) Beauv., Boedjen-Mt. Kawi (1300 m), 13.ii.1951 (2); *Oplismenus compositus* (L.) Beauv., Kleleng-Mt. Lawu (1200 m), 20.vi.1951 (2); *Oplismenus compositus* (L.) Beauv., Cibodas (1600 m), 6.vii.1975 (3); *Oplismenus compositus* (L.) Beauv., Sindanglaya (1200 m), 17.vii.1975 (3); *Cyrtococcum accrescens* (Trin.) Stapf, Sindanglaya (1100 m), 25.ii.1976 (3); *Oplismenus compositus* (L.) Beauv., Sindanglaya (1100 m), 29.v.1976 (3); *Setaria palmifolia* (Willd.) Stapf, Sindanglaya (1100 m), 29.v.1976 (3);

*Oplismenus compositus* (L.) Beauv., Cibodas (1400 m), 29.v.1977 (3); *Oplismenus compositus* (L.) Beauv. Mt. Salak (800 m), 22.vii.1977 (3); *Cyrtococcum accrescens* (Trin.) Stapf, Sindanglaya (1100 m), 31.x.1977 (3).

The aphids live on the lower side of leaves, on stems and between the inflorescence, which are all frequently densely covered by wax.

Alatae or larvae of alatae were collected vi.1916, viii.1916, 2.v.1950, 18.vii.1950, 20.vi.1951, 6.vii.1975, 17.vii.1975, 29.v.1976, 29.v.1977, and 22.vii.1977.

Etymology.— *Panicola*, living on *Panicum*, the host from which the aphids were collected in Formosa, and described by Takahashi (1921).

***Pseudoregma pendleburyi* (Takahashi, 1950)**  
(figs. 421-423)

*Oregma pendleburyi* Takahashi, 1950: 597.

*Pseudoregma pendleburyi*; Eastop & Hille Ris Lambers, 1976: 366.

Apterous viviparous female.— In life (pl. 42): Body blackish brown, marbled. The head and distal end of the body brown. Antennae and legs pale brown, distal end of antennae slightly darker. Eyes black. Cauda and anal plate brown. Small columns of wax may be present on each of the thoracic segments and abdominal segments I-VI marginally and in two rows spinally; small wax columns from mesothorax to abdominal segment VI may constitute a fifth and sixth row of wax: on the head two columns of wax can be present. Between the columns of wax the body is covered with a dull granular layer of wax, which breaks into white scales when pressed. Ventrally, except in the middle, the body is covered with a rather thick layer of granular wax. Larvae brown with wax as the adult. Soldiers yellowish brown, only with granular wax.

Macerated specimens.— (fig. 421; described from 10 specimens). Body 1.35-2.10 mm long, 1.4-1.7 times as long as it is wide.

Head.— Head pale brown, with pustules having an irregular, more or less star-shaped outline, with dotted surface, and a diameter of 6-12  $\mu$ ; frons not protruding in the middle, head across the eyes 360-480  $\mu$  wide. Horns tapering to the ends, the tips rounded, with 10-12 hairs, 8-14  $\mu$  long; length of the horns 45-73  $\mu$ , 0.10-0.17 times as long as the width of the head across the eyes. Head dorsally with 4-6 anterior hairs, and between the eyes an anterior and posterior row of hairs, each with four hairs, 30-48  $\mu$  long. Wax glands medial to the eyes on each side, in an oval group with a diameter of 15-65  $\mu$ , with 1-9 glands, squeezed flat against each other, a thickened outer border is only rarely present, between the glands are colourless lines only; depending on the adjustment the glands are dotted or with facets of less than two  $\mu$  wide. The glands are sometimes lacking in specimens of a collection with larvae of alatae. Antennae with four or five segments, pale brown, the last segment slightly darker, 265-360  $\mu$  long, 0.14-0.20 times as long as the body, 0.58-0.77 times the width of the head across the eyes, and 0.66-0.90 times as long as the tibia of the fore leg; the segments with smooth imbrications or wrinkles. In four-segmented antennae III, 100-157  $\mu$  long, 1.2-1.7 times as long as IV, with 3-6 hairs, 17-28  $\mu$  long; segment

IV, 80-96  $\mu$  long, the processus terminalis 18-29  $\mu$  long, with two hairs, and five apical setae 13-15  $\mu$  long. In five-segmented antennae III, 75-100  $\mu$  long, 0.9-1.8 times as long as IV, 0.8-1.1 times as long as V, with 2-3 hairs; IV, 50-80  $\mu$  long, 0.5-0.9 times as long as V, with three hairs; V, 85-101  $\mu$  long, the processus terminalis 20-30  $\mu$  long, with two hairs and five apical setae. Eyes darker brown than the head, with three ommatidia. Ultimate rostral segment 86-101  $\mu$  long, 0.69-0.94 times as long as the second tarsal segment of the hind leg. Stylets 355-430  $\mu$  long.

Thorax.— Prothorax the same colour as the head, with pustules, fused with the head; pleurally a groove is observable, passing from the posterior margin to a large muscular plate anteriorly, 20-30  $\mu$  deep in relation to the elongate-oval swelling on each side of the median line; these swellings fall sharply at these grooves, on the anterior and posterior sides and at the median groove; the pustules on these swellings are numerous, and frequently partly with thickened margins, with a dotted surface observable at a magnification of 400; on each side two marginal hairs, zero anterior, and 2-7 posterior dorsal hairs; posteromarginally 0-7 wax glands on each side in an oval group, and spinally two groups of 0-9 wax glands. Mesothorax pale brown, with pustules having an irregular border, with a median groove, and a pleural longitudinal groove with a muscular plate, marginally with an oval group with 0-7 faceted wax glands, and two spinal groups with 0-9 glands; dorsally 5-8 hairs. Metathorax sclerites as mesothorax, marginally with an oval group of 0-5 wax glands, and spinally two groups with 0-8 glands; dorsally with 5-8 hairs. Legs almost evenly pale brown, the femora and second tarsal segments with some spinulose imbrications, other parts of the legs almost smooth. Tibia of the fore leg 305-425  $\mu$  long, 0.69-0.93 times as long as the width of the head across the eyes. First tarsal segment of fore leg with four hairs, the lateral 2.2-2.9 times as long as the middle hairs, of the midleg with 3-4 hairs, of the hind leg with two hairs, 40-57  $\mu$  long. Second tarsal segments of the hind leg 0.21-0.23 times as long as the width of the tibia of the hind leg, and 0.28-0.34 times the width of the head across the eyes, with one dorsoapical hair expanded at the tip, 59-72  $\mu$  long, the tip 2-4  $\mu$  wide. Empodial hairs of the hind leg 37-45  $\mu$  long. Length of segments of the hind leg: femur plus trochanter 332-472  $\mu$ , tibia 456-661  $\mu$ , 1.35-1.44 times as long as the femur, and 1.11-1.41 times the width of the head across the eyes, first tarsal segment 45-47  $\mu$ , second tarsal segment 102-145  $\mu$ .

Abdomen.— Abdominal segments I-VII pale brown, but between the marginal and dorsal sclerites some colourless patches. Marginal sclerites with, 15-95  $\mu$  wide, oval groups of wax glands with a diameter of 15-40  $\mu$ , the glands number on segment I, 0-4; II, 0-5; III, 0-6; IV, 0-3; V, 0-5; VI, 0-4; VII, 0-4; on four of the 20 specimens on the marginal sclerites of abdominal segment I as well as of VII, wax glands are lacking. Spinally two groups of wax glands may be present and number: on I, 0-5; II, 0-7; III, 0-6; IV, 0-5; V, 0-4; VI, 0-5; VII, 0; the lack of wax glands on all segments I-VII only occurred in a few of the 44 specimens, from a collection with larvae of alatae. Pustules, star-shaped wax glands, marginally on segments I-VII, dorsally on segments I and II as distinct as on the thorax, but on the next segments rather indistinct, tergites V-VII with spinulose imbrications. Tergite I with 5-11 hairs; II with 6-8; III, 6-9; IV, 4-9; V, 4-10; VI, 1-4; VII, 1-3; length of hairs on tergite IV, 27-45  $\mu$ , ventrally on IV, 33-43  $\mu$ . Tergite VIII with a transversely elongate pale brown plate, e.g. 330  $\mu$  wide, and 88  $\mu$  long, the anterior side rounded, the posterior margin straight or

slightly emarginate, with spinulose imbrications, and 4-9 hairs, 40-55  $\mu$  long; spinally 0-6 wax glands, but only lacking in one specimen of 44, from a collection with larvae of alatae. S-shaped wax glands observable on some ventral parts of the body. Siphunculi located dorsally on segment V, same colour as other sclerites, with some concentrically arranged imbrications and spinulae, and with star-shaped pustules, at the base 105-180  $\mu$ , without a distinct border with the surroundings, with 2-5 hairs; pore brown, elevated above the base 15-30  $\mu$ , the margin of the pore about 30-50  $\mu$  from the margin of the abdomen, diameter of the pore 38-55  $\mu$ . Cauda transversely elongate, e.g. 155  $\mu$  wide at the base, the knob 106  $\mu$  wide, the length of the knob 35  $\mu$ , and diameter of the constriction 82  $\mu$ ; the knob 83-130  $\mu$  wide, with 9-11 hairs, the longest 73-106  $\mu$ . Subanal plate bilobed, with 12-18 hairs, the longest 76-113  $\mu$ . Subgenital plate with 2-5 anterior hairs, 35-51  $\mu$  long, and 12-18 posterior hairs, 31-43  $\mu$  long. Gonapophyses two, each with 7-10 hairs, the longest 10-15  $\mu$ .

Alate viviparous female.— Macerated specimens (described from six specimens). Similar to *P. bambusicola* but: The head ventrally on each side with 4-7 hairs. The processus terminalis 10-18  $\mu$  long. The stylets 365-393  $\mu$  long. Tibia of the fore leg 1.15-1.27 times as long as the width of the head across the eyes. Cauda with 13-15 hairs, the longest 74-86  $\mu$ . Longest hairs of the subanal plate 82-90  $\mu$ .

First stage larvae of apterous viviparous females exist as the type which develops into adult specimens, and in a "soldier" type which does not develop into later stages. A description of both types is given.

First stage larva of apterous viviparous female (fig. 422; description of one specimen). Body length 742  $\mu$ , length of head plus pronotum 251  $\mu$ , 0.74 times the width of the prothorax; width of the head across the eyes 267  $\mu$ , the head dorsally, and dorsal to the horns with four hairs, and two rows each of four hairs between the eyes, about 37  $\mu$  long. Antennae with four segments, 228  $\mu$  long, segment III smooth, 75  $\mu$  long, IV with smooth imbrications, 88  $\mu$  long, with the processus terminalis 35  $\mu$ ; length of hair on segment II, 30  $\mu$ ; on III, 27  $\mu$ . Frons with two horns, pointed, smooth, 110  $\mu$  long, and 40  $\mu$  wide at the base, with hairs 4-6  $\mu$  long, and one hair basally 33  $\mu$  long. Fore legs normal, the femur 236  $\mu$  long, and 57  $\mu$  wide in the middle, 0.88 times as long as the width of the head across the eyes; tibia of the fore leg not curved at the basal part, 264  $\mu$  long; length of distal hairs of the hind tibia 55  $\mu$ . All first tarsal segments with two hairs, about 78  $\mu$  long. Two dorsoapical hairs of the second tarsal segment of the hind leg with expanded tips, 66  $\mu$  long, the other apical hairs smaller and acute. Medial to the eyes on each side a group of wax glands, marginal wax gland groups on the thoracic and abdominal segments I-VII, and a pair of spinal groups of wax glands on each of the thoracic segments and abdominal segments I-VI; spinal wax glands lacking on abdominal segment VII; on segment VIII one group, 23  $\mu$  wide, and about 10  $\mu$  long. Marginal and dorsal thoracic and abdominal sclerites, pale brown, with wax gland groups, pustules, and hairs; abdominal segments dorsal to the marginal wax glands with one hair, tergites I-IV with four hairs, V-VIII with two, on VIII, 42  $\mu$  long. Cauda with two hairs, 43  $\mu$  long. Siphunculi absent.

First stage larva "soldier" type (fig. 423; description of one specimen). Body length 950  $\mu$ , length of head plus pronotum 358  $\mu$ , 0.90 times the width of the prothorax, width of the head across the eyes 345  $\mu$ ; the head dorsally with five anterior hairs, and between the eyes an anterior and posterior row each of four hairs, about

25  $\mu$  long; ventrally on each side 5-6 hairs, the longest 75  $\mu$  long. Antennae with four segments, 308  $\mu$  long, segment III, 125  $\mu$  with a few smooth imbrications, IV with smooth imbrications, 105  $\mu$  long, length of hair on segment II, 22  $\mu$ ; on III, 27  $\mu$ . Frons with two horns, pointed, smooth, 190  $\mu$  long, and 90  $\mu$  wide at the base, with hairs 4-6  $\mu$  long. Fore legs darker brown, more sclerotic and more sturdy than the other legs; femur of the fore leg 417  $\mu$  long, and 108  $\mu$  wide in the middle, 1.21 times as long as the width of the head across the eyes; tibia of the fore leg curved at the basal part, 415  $\mu$  long; length of the distal hairs of the hind tibia 92  $\mu$ . All first tarsal segments with two hairs, of the hind leg 100  $\mu$  long; diameter of the base of the first tarsal segment of the fore leg 40  $\mu$ , 1.4 times as wide as that of the hind leg. Two dorsoapical hairs of the second tarsal segment of the hind leg with expanded tips, 85  $\mu$  long, the other apical hairs smaller and acute. Wax glands lacking on nearly all segments of the body; star-shaped oval wax glands, pustules, on all sclerotic parts of the body. Marginal abdominal segments dorsally with one hair, tergites I-V with four hairs, VI-VIII with two, on VIII, 43  $\mu$  long. Cauda with two hairs, 60  $\mu$  long. Siphunculi absent or rudimentary.

Host plant records.— Specimens were collected in Java on the plants, in the places, and on the dates indicated, while the collectors are indicated by numbers between parentheses: P. van der Goot (1), in the collection at the Laboratorium voor Entomologie, Wageningen; F.W. Rappard (2), and P. Büchner (3), both in the collection at the British Museum (Natural History), Londen; and D. Noordam (4), in the collection at the Rijksmuseum van Natuurlijke Historie, Leiden. Bamboo, Bogor, 15.xii.1920 (1); bamboo, Petoeng-Djember, 29.v.1950, 22.vii.1950 (2); bamboo, Gombang (350 m), 8.viii.1950 (2); bamboo, Bogor 7.vi. - 30.vii.1956 (3); *Bambusa schizostachyoides* Kurz., Bogor, Kebun Raya, 10.ii.1976 (4); *Schizostachyum blumii* Nees, Bogor, Kebun Raya, 10.ix.1976, 25.xii.1976, 7.ii.1978 (4); bamboo, Padelaran, 2.i.1978 (4).

The aphids live on the branches of the culms, on internodes and nodes.

Alatae were collected 2.i.1978, larvae of alatae 10.ix.1976.

Etymology.— Pendleburyi, name given by Takahashi (1950) to commemorate H. M. Pendlebury, who collected this aphid 15.iii.1928 on the Malay peninsula.

***Pseudoregma sundanica* (Van der Goot, 1917)**  
(figs. 424-431)

*Oregma sundanica* Van der Goot, 1917: 230.

*Pseudoregma sundanica*; Eastop & Hille Ris Lambers, 1976: 366.

Types.— Lectotype (apterous viviparous female) from probably *Curculigo capitulata* (Lour.) O.K. (syn. *Molineria capitulata* (Lour.) Herb.), Mt. Mandalawangi, Tjitjalingka, 1400 m (on slides: Siti Ardja), 28.viii.1915, leg. P. v.d. Goot, no. 297-1-1, det. P. v. d. Goot *Oregma sundanica*. Paralectotypes: apterae viviparae on 13 slides with the same data as the lectotype. Lectotype and paralectotypes in the collection at the Laboratorium voor Entomologie, Wageningen.

Apterous viviparous female.— In life (pls 43, 44): Body blackish brown or black, but the last abdominal segments paler. Antennae pale brown, the last segment or segments darker. Legs pale brown, the second tarsal segments darker. Eyes black.



Cauda and anal plate brown. Columns of wax may be present marginally on thorax and abdominal segments I-VII, two columns on the head, and two spinal rows of columns on thorax and abdominal segments I-VI, sometimes also a pleural row from metathorax to abdominal segment VI, segment VIII with one spinal column of wax; the space between the columns is covered with a wax layer, outside with a granular appearance, when pressed the wax layer breaks into white scales. Many columns of wax may be lacking, while a continuous cushion of wax ventral to the marginal wax glands, and a more or less pleural cushion of wax sometimes occurs. Larvae more brownish, the soldier type almost without wax.

Macerated specimens.— (fig. 424; described from 14 specimens). Body 1.12-2.03 mm long, 1.4-1.9 times as long as it is wide.

Head.— Head pale brown or brown, with pustules having an irregular, more or less star-shaped outline, with dotted surface, with a diameter of 6-12  $\mu$ ; frons not protruding in the middle, head across the eyes 363-504  $\mu$  wide. Horns tapering to the end, the tips rounded, with 10-12 hairs, 4-8  $\mu$  long, one basal hair, however, sometimes up to 14  $\mu$ ; length of horns 38-60  $\mu$ , 0.08-0.14 times as long as the width of the head across the eyes. Head dorsally with 4-9 anterior hairs, and between the eyes an anterior row of four hairs, and a posterior row of 4-6, 28-45  $\mu$  long. Wax glands medial to the eyes on each side, in an oval group with a diameter of 15-75  $\mu$ ; 1-10 glands, squeezed flat against each other, the outer border sometimes partly thickened, but between the glands only colourless lines; depending on the adjustment, the glands are dotted or with facets of about two  $\mu$  wide. The glands were present in specimens of 11 out of 15 populations, usually lacking in collections with alatae. Antennae with four or five segments, pale brown, the last segment slightly darker, 263-420  $\mu$  long, 0.19-0.23 times as long as the body, 0.69-0.89 times the width of the head across the eyes, and 0.82-0.94 times as long as the tibia of the fore leg; the segments with smooth imbrications or wrinkles. In four-segmented antennae III, 104-160  $\mu$  long, 1.1-1.5 times as long as IV, with 3-7 hairs, 18-25  $\mu$  long; segment IV, 84-115  $\mu$  long, the processus terminalis 30-39  $\mu$  long, with two hairs, and five apical setae, 12-16  $\mu$  long. In five-segmented antennae, III, 78-123  $\mu$  long, 1.0-1.6 times as long as IV, 0.7-1.1 times as long as V, with 2-5 hairs; IV, 63-84  $\mu$  long, 0.6-0.8 times as long as V, with 3-4 hairs; V, 93-121  $\mu$  long, the processus terminalis 35-43  $\mu$  long, with two hairs and five apical setae. Eyes darker brown than the head, with three ommatidia. Ultimate rostral segment 94-123  $\mu$  long, 0.72-0.96 times as long as the second tarsal segment of the hind leg; stylets 415-530  $\mu$  long.

Thorax.— Prothorax the same colour as the head, with more distinct pustules than on the head, fused with the head; pleurally a groove is observable, passing from the posterior margin to a large muscular plate anteriorly, 20-30  $\mu$  deep in relation to the elongate-oval swelling on each side of the median line; the swellings fall sharply at these grooves, on the anterior and posterior sides and at the median groove; the pustules on these swellings are numerous, sometimes with thickened margins, and with a dotted surface observable at a magnification of 400. On each side two marginal hairs, dorsally zero anterior, and 2-5 posterior hairs; posteromarginally 0-5 wax glands on each side in an oval group, and spinally two groups of 0-7 wax glands. Mesothorax, marginal and dorsal sclerites united, pale brown, with pustules having an irregular border, with a median groove, and a pleural longitudinal groove with a muscular plate; marginally with an oval group with 0-8 faceted wax glands, and two

spinal groups with 0-6 glands; dorsally 4-8 hairs. Metathorax sclerites as mesothorax, marginally with an oval group of 0-7 wax glands, and spinally two groups with 0-5 glands; dorsally with 6-10 hairs. Legs almost evenly pale brown, the second tarsal segments with some smooth imbrications and some spinulae, other parts of the legs almost smooth. Tibia of the fore leg 306-480  $\mu$ , 0.81-1.02 times as long as the width of the head across the eyes. First tarsal segments of fore leg with four hairs, the lateral 2.1-3.0 times as long as the middle hairs, of the midleg with 3-4 hairs, of the hind leg with two hairs, 43-53  $\mu$  long. Second tarsal segment of the hind leg 0.17-0.22 times as long as the tibia of the hind leg, and 0.27-0.31 times as long as the width of the head across the eyes, with 1-2 dorsoapical hairs expanded at the tips, 55-76  $\mu$  long, the tips 2-4  $\mu$  wide. Empodial hairs of the hind leg 35-47  $\mu$  long. Length of the segments of the hind leg: femur plus trochanter 327-559  $\mu$ , tibia 456-748  $\mu$ , 1.34-1.44 times as long as the femur, and 1.24-1.61 times the width of the head across the eyes, first tarsal segment 35-43  $\mu$ , second tarsal segment 98-153  $\mu$ .

Abdomen.— Abdominal segments I-VII pale brown, but usually between the marginal and dorsal sclerites a longitudinal colourless band, which is widest on segment VI, sometimes also a colourless zone at the segmental borders. Marginal sclerites frequently with oval wax gland groups, 20-100  $\mu$  wide, with glands having a diameter of 8-60  $\mu$ ; the glands number on segment I, 0-4; II, 0-6; III, 0-5; IV, 0-5; V, 0-5; VI, 0-5; VII, 1-6; on 45 of 78 marginal sclerites of abdominal segment I wax glands are lacking, especially in collections with alatae, while in all specimens wax glands are present on the marginal sclerites of segment VII. A pair of wax gland groups may be present spinally, and number on segment I, 0-3; II, 0-4; III, 0-3; IV, 0-3; V, 0-2; VI, 0-5; in more than half the specimens spinal wax glands are lacking on several segments, and in specimens of some collections all spinal wax glands are lacking. Spinal wax glands are lacking on segment VII. Tergite I with 7-11 hairs; II with 5-9; III, 6-12; IV, 7-14; V, 5-10, or up to 16 if the hairs medial to the siphunculi are included; VI, 2-5; VII, 2-3; length of hairs on tergite IV, 25-41  $\mu$ , ventrally on IV, 27-47  $\mu$ . Tergite VIII with a transversely elongate pale brown plate, e.g. 350  $\mu$  wide, and 85  $\mu$  long, the anterior side rounded, the posterior margin almost straight, with spinulose imbrications, and 4-8 hairs, 37-59  $\mu$  long; spinally 0-4, usually not more than two, wax glands in one group, 30-80  $\mu$  wide, 22-38  $\mu$  long; in half the specimens wax glands are lacking on segment VIII. Star-shaped wax glands are present on the dorsal side of the body, and s-shaped wax glands ventrally. Siphunculi located dorsally on segment V, pale brown, with some concentrically arranged imbrications and some fine spinulae, at the base 140-240  $\mu$  wide, but no distinct border in respect to the surroundings, with usually 3-7 hairs; pore brown, elevated above the base 25-40  $\mu$ , the margin of the pore about 40-80  $\mu$  from the margin of the abdomen, diameter of the pore 32-53  $\mu$ . Cauda transversely elongate, e.g. 150  $\mu$  wide at the base, the knob 106  $\mu$  wide, the length of the knob 35  $\mu$ , and diameter of the constriction 65  $\mu$ ; the knob 84-120  $\mu$  wide, with 8-14 hairs, the longest 69-96  $\mu$ . Subanal plate bilobed, with 14-19 hairs, the longest 84-102  $\mu$ . Subgenital plate with four anterior hairs, 35-56  $\mu$  long, and 10-15 posterior hairs, 37-55  $\mu$  long. Gonapophyses two, each with 6-9 hairs, the longest 8-14  $\mu$ .

Alate viviparous female.— In life: Body black. Legs black, base of the femur, and the tibiae slightly paler. Pterostigma black.

Macerated specimens.— (figs. 425-429; described from 10 specimens). Body length 1.63-1.95 mm, 1.9-2.8 times as long as it is wide.

Head (fig. 425).— Head black, dorsally with blunt spinulae of about one  $\mu$  diameter, anterior and medial to the paired ocelli with some concentric wrinkles; width of the head across the eyes 424–485  $\mu$ , on the head dorsal to the horns or the location of the horns with 8–13 short hairs, 12–16  $\mu$  long. Frons with or without two horns with rounded tip, 0–18  $\mu$  long, with on the horns or on the location of the horn on each side 10–17 hairs, 5–7  $\mu$  long. Ventrally, posterior to the median ocellus, 13–14 hairs on each side. Antennae black, with five segments, 655–735  $\mu$  long, 0.36–0.44 times as long as the body, and 1.4–1.7 times the width of the head across the eyes; segment I wrinkled, segment II with longitudinal wrinkles, and dorsally and ventrally with spinulose imbrications, the spinulae 1–3  $\mu$  long; segments III–V (fig. 426) with ring-shaped secondary rhinaria, the rings are not closed on the dorsal side, with a space of 4–30  $\mu$ ; between the rhinaria are 3–5 concentric spinulose imbrications, dorsally and ventrally with interconnections; the rhinaria are 3–4  $\mu$  wide. The primary rhinaria are between the annular rhinaria and moulded with them to a complex structure; segment III with 18–32 annular rhinaria, IV with 9–15, V with 6–10; hairs on segment III, 12–15  $\mu$  long. Length of segment III, 270–325  $\mu$ , 1.8–2.2 times as long as IV, 1.9–2.5 times as long as V, and 1.0–1.2 times as long as IV plus V; segment IV, 126–160  $\mu$  long, 0.9–1.2 times as long as V; V, 120–160  $\mu$  long, the processus terminalis 23–35  $\mu$ . The last rostral segment is 98–113  $\mu$  long, 0.78–0.89 times as long as the second tarsal segment of the hind leg, without accessory hairs; length of the stylets 350–425  $\mu$ . Eyes compound, the ocular tubercle extending sideways 20–25  $\mu$ .

Thorax.— Sides of the prothorax pale brown or brown, the mesothorax black. Fore wing (fig. 427) medial vein once branched, the hind wing with two oblique veins. Legs black, the distal part of the femur and the basal part of the tibia sometimes darker, femora and tibiae smooth, all second tarsal segments with spinulose imbrications. The tibia of the fore leg 500–560  $\mu$  long, 1.05–1.23 times as long as the width of the head across the eyes, length of distal hairs of the hind tibia 26–33  $\mu$ ; chaetotaxy of first tarsal segments 4, 3–4, 2, the lateral hairs of the fore tarsus 1.7–2.4 times as long as the middle hair; length of hairs of first tarsal segments of the hind leg 31–40  $\mu$ ; second tarsal segment of the hind leg (fig. 428) with one dorsoapical hair with expanded tip, 53–62  $\mu$  long, the tip 3–4  $\mu$  wide; length of the empodial hair of the hind leg 32–40  $\mu$ . Length of the hind segments: femur fused with trochanter 460–535  $\mu$ ; tibia 630–732  $\mu$ , 1.3–1.4 times as long as the femur, and 1.3–1.5 times the width of the head across the eyes; first tarsal segment 37–40  $\mu$  long, second tarsal segment 113–131  $\mu$ .

Abdomen.— (fig. 429). Abdominal segments I–VI colourless; VII margins and dorsum with one pale brown plate with spinulose imbrications; VIII pale brown, with straight posterior margin, usually pleurally with a denticle 4–8  $\mu$  high, with spinulose imbrications; number of hairs on tergite III, 7–14; IV, 9–13 with a length of 14–21  $\mu$ ; V between the siphunculi 7–13; VI, 2–5; VII, 2–4; VIII, 5–11, 33–45  $\mu$  long. Siphunculi located on tergite V, around the pore with a pale brown sclerite which is widest posteriorly, 25–55  $\mu$  with some concentric wrinkles and blunt spinulae with a diameter of one  $\mu$ ; the pore yellowish brown, about 15  $\mu$  above the surroundings, diameter of the pore 35–40  $\mu$ . Cauda transversely elongate, the base not well-defined, e.g. the knob 90  $\mu$  wide, 33  $\mu$  long, and diameter of the constriction 83  $\mu$ ; the knob is 78–96  $\mu$  wide, with 11–14 hairs, the longest 55–65  $\mu$ . Subanal plate bilobed, with 17–19 hairs, the longest 65–76  $\mu$ . Subgenital plate with 7–9 hairs on the plate, four of which

anteriorly, the longest 39-45  $\mu$ , and 8-14 hairs along the posterior margin, the longest 43-55  $\mu$ . Gonapophyses two, each with 7-11 hairs, the longest 18-30  $\mu$ . Spiracles on seven abdominal segments, I-VII.

First stage larvae of apterous viviparous females exist as the type which develops into adult specimens, and as a "soldier" type, which does not develop into later stages. A description of both types is given below.

First stage normal larva of apterous viviparous female (fig. 430; description of one specimen). Body length 918  $\mu$ , length of head plus pronotum 287  $\mu$ , 0.85 times the width of the prothorax; width of the head across the eyes 279  $\mu$ , the head dorsally, and dorsal to the horns with four hairs, and two rows each of four hairs between the eyes, 35-40  $\mu$  long. Antennae with four segments, 280  $\mu$  long, segment III dorsally smooth, ventrally with some smooth imbrications, 102  $\mu$  long, IV with smooth imbrications, 102  $\mu$  long, with the processus terminalis 41  $\mu$ ; length of hair on segment II, 34  $\mu$ ; on III, 31  $\mu$ . Frons with two horns, pointed, smooth, 125  $\mu$  long, and 57  $\mu$  wide at the base, with hairs 4-6  $\mu$  long, and one hair basally 24  $\mu$  long. Fore legs normal, the femur 283  $\mu$  long, and 64  $\mu$  wide in the middle, 1.01 times as long as the width of the head across the eyes; tibia of the fore leg not curved at the basal part, 308  $\mu$  long; length of distal hairs of the hind tibia 70  $\mu$ . All first tarsal segments with two hairs, of the hind leg 86  $\mu$  long. Two dorsoapical hairs of the second tarsal segment of the hind leg with expanded tips, 71  $\mu$  long, the other apical hairs 55  $\mu$  long, thinner but also with expanded tips. Medial to the eyes on each side a group of wax glands, marginal wax glands groups on the thoracic segments and abdominal segments I-VII, and a pair of spinal wax gland groups on each of the thoracic segments and abdominal segments I-VI; spinal wax glands lacking on abdominal segment VII; on segment VIII wax glands lacking, but in other specimens sometimes one or two glands present. Marginal and dorsal thoracic and abdominal sclerites pale brown, with the wax gland groups, pustules and hairs; abdominal segments dorsal to the marginal wax glands with one hair, tergites I-IV with four hairs, V with three, VI-VIII with two, on VIII, 52  $\mu$  long. Cauda with two hairs, 53  $\mu$  long. Siphunculi absent.

First stage larva "soldier" type (fig. 431; description of one specimen). Body length 1290  $\mu$  (other specimens from 900  $\mu$ ), length of head plus pronotum 410  $\mu$ , 0.95 times the width of the prothorax, width of the head across the eyes 381  $\mu$ ; head dorsally with five anterior hairs, and between the eyes an anterior and posterior row each of four hairs, 27-40  $\mu$  long. Antennae with four segments, 380  $\mu$  long, segment III, 172  $\mu$ , with smooth imbrications, IV with smooth imbrications, 135  $\mu$  long, length of hair on segment II, 29  $\mu$ ; on III, 33  $\mu$ . Frons with two horns, smooth, 255  $\mu$  long, and 98  $\mu$  wide at the base, with hairs six  $\mu$  long. Fore legs darker brown, more sclerotic and sturdy than the other legs; femur of the fore leg 535  $\mu$  long, and 145  $\mu$  in the middle, 1.40 times as long as the width of the head across the eyes; tibia of the fore leg curved at the basal part, 555  $\mu$  long; length of the distal hairs of the hind tibia 92  $\mu$ . All first tarsal segments with two hairs, of the hind leg 110  $\mu$  long, diameter of the base of the first tarsal segment of the fore leg 47  $\mu$ , 1.5 times as wide as that of the hind leg. Two dorsoapical hairs of the second tarsal segment of the hind leg with expanded tips, 104  $\mu$  long, the other apical hairs smaller and acute. Wax glands lacking on nearly all segments of the body; star-shaped oval wax glands, pustules, on all sclerotic parts of the body. The marginal abdominal sclerites dorsally each with one hair, tergites I-IV with 4-5 hairs, V with 2-3, VI-VIII with two, on VIII, 71  $\mu$  long.

Cauda with two hairs, 68  $\mu$  long. Siphunculi absent or rudimentary.

Host plant records.— Specimens were collected in Java on the plants, in the places, and on the dates indicated, while the collectors are indicated by numbers between parentheses: P. van der Goot or Van der Goot (1917),(1), in the collection at the Laboratorium voor Entomologie, Wageningen; Franssen (2) and F.W. Rappard (3) both in the collection at the British Museum (Natural History), London; and D. Noordam (4), in the collection at the Rijksmuseum van Natuurlijke Historie, Leiden. *Curculigo capitulata* (Lour.) O.K., probably; Siti Ardja-Mt. Mandalawangi, Tjitjalengka (1400 m), 28.viii.1915 (1); *Amomum gracile* Bl., Linggo-Pekalongan (500 m), 18.vi.1916 (1); Zingiberaceae, Bogor, 19.x.1917 (1); *Costus* spec., Bogor, 28.viii.1919; 13.iii.1920 (1); Zingiberaceae, Salak (1200 m), 1.viii.1928 (2); *Zingiber* spec., Mt. Kalat (1400 m), 8.viii.1951 (3); *Costus afer* Ker-Gawl., Bogor, Kebun Raya, 9.xi.1975, 29.ii.1976 (4); *Nicolaia hemisphaerica* (Bl.) Horan, Bogor, Kebun Raya, 5.iii.1976 (4); *Costus mexicanus* Liebm., Bogor, Kebun Raya, 25.xii.1976 (4); *Alpinia* spec., Bogor, Kebun Raya, 25.xii.1976 (4); *Catimbium malaccensis* (Burm.f.) Holtt., Bogor, Kebun Raya, 5.ix.1977 (4); *Alpinia schumanniana* Val., Bogor, Kebun Raya, 5.ix.1977 (4); *Catimbium malaccensis* (Burm.f.) Holtt., Bogor-Deramaga, 18.ii.1978 (4); *Catimbium malaccensis* (Burm.f.) Holtt., Bogor, Kebun Raya, 18.ii.1978 (4).

The aphids live densely together on the base of the petiole (*Alpinia*), on the petiole at the base of the leaf blade or lower, and in one case on the main vein (*Catimbium*), on the leaf sheaths of four successive leaves in one case (*Nicolaia*), on the young stem and bases of leaves (*Costus*). Larvae wave their hind legs. Visited by ants and sometimes completely enclosed by pieces of leaves and flowers.

Alatae or larvae of alatae were collected 28.viii.1915, 19.x.1917, 28.viii.1919, 9.xi.1975, 25.xii.1976, 18.ii.1978.

Etymology.— Sundanica, from the West, Sundanese part of Java, name given by Van der Goot (1917).

### Genus *Rappardiella* nov.

(figs. 432 - 493)

*Oregma*; Van der Goot, 1917: 171, partly. Type species *Oregma loranthi* Van der Goot, 1917.

Description.— Apterous viviparous female.— (five species). In life: Yellowish white, orange, brown or black, with a dull transparent layer of wax, or with flaky wax or a fringe of wax columns.

Macerated specimens.— Body pale brown or brown, 1.1-2.1 mm long, 1.2-1.7 times as long as it is wide. The head fused with the pronotum, meso- and metathorax usually with marginal and dorsal segmental borders; abdominal segments I-VI or I-VII fused, segment I only with a dorsal furrow. The head ventrally with a pair of half globular horns, with broadly rounded tips, with on top one sturdy short hair on a process; in *R. macrosoleni* and *R. plicator* the horns are lacking, but 2-5 or two pairs of short, sturdy hairs are present. Other dorsal and ventral hairs of the head normal, 23-96  $\mu$  long. Wax gland groups medial to the eyes lacking or with up to three glands. Antennae with five segments, 287-590  $\mu$  long, 0.25-0.40 times as long as the body, and 0.7-1.5 times the width of the head across the eyes; the last antennal segment 3.1-5.8

times as long as its processus terminalis. The eyes with three ommatidia, in *R. loranthi* rectangular, protruding from the head 22-29  $\mu$ . Ultimate rostral segment without accessory hairs, 0.68-1.43 times as long as the second tarsal segment of the hind leg; stylets 325-725  $\mu$  long. Length of the head plus pronotum 0.57-0.75 times the width of the prothorax. Sometimes, in *R. loranthi* and *R. scurrulae*, a distinct groove runs posterior to the eyes in a posteriomedial direction, and pleurally a groove passes from the posterior margin forwards to a large muscular plate; sometimes a median groove with on each side a swelling; wax gland groups in *R. loranthi* and *R. scurrulae* marginally in a longitudinal row of 6-10 glands, and in *R. loranthi* spinally two groups of 3-9 glands. Meso- and metathorax in *R. loranthi* and *R. scurrulae* with marginal wax glands in a longitudinal row, and each dorsally with 17-33 hairs; the other species without wax gland groups, and dorsally with 3-9 hairs. Legs smooth, but the second tarsal segments with some spinulae; tibia of the fore leg 0.48-0.85 times as long as the width of the head across the eyes. First tarsal segments of the fore leg with four, or in *R. macrosoleni* rarely with three hairs; of the midleg with 3-4 hairs, of the hind leg with two. Second tarsal segments of the hind leg with two dorsoapical hairs with expanded tips, empodial hairs 22-37  $\mu$  long. Abdominal segments I-VII very pale brown, pale brown or brown, with more or less distinct pustules, and *R. macrosoleni* with indistinct lines somewhat as convolutions of the brain; ventrally sometimes linear s-shaped wax glands are distinct. Wax gland groups, marginally in a longitudinal line of 2-5 glands on each segment in *R. loranthi* and *R. scurrulae*, but lacking in the other species. Tergites I-V in *R. loranthi* and *R. scurrulae* with 11-30 hairs, in the other species with 2-11; length of hairs on tergite IV, 25-102  $\mu$ ; tergite VI with 2-20, VII with 2-9 hairs. Tergite VIII with spinulose imbrications, with 4-12 hairs, 30-98  $\mu$  long; *R. loranthi* and *R. scurrulae* marginally on each side usually 1-5 wax glands, spinal groups of wax glands are lacking; in the other species wax gland groups are lacking. Siphunculi located on segment IV or V, a cone with concentric wrinkles, or flat and the same colour as the surroundings, the pore with a diameter of 27-80  $\mu$ , with 2-25 hairs. Cauda transversely elongate without a constriction or, in *R. loranthi* a knob with a constriction, with 6-12 hairs, the longest 30-61  $\mu$ . Subanal plate bilobed, with 12-26 hairs, the longest 37-89  $\mu$ . Subgenital plate with 2-12 anterior, and 5-15 posterior hairs. Gonapophyses two, each with 1-10 hairs.

First stage larvae of apterous viviparous females exist as the type which develops into adult species. In *R. cerina*, *R. macrosoleni*, and *R. scurrulae* siphunculi are present; of the other species it is not known whether siphunculi are present or not.

Alate viviparous female.— (four species). In life black or the abdomen brownish black. The pterostigma greyish or greenish black or black.

Macerated specimens.— Body length 1.3-2.5 mm, 1.7-2.3 times as long as it is wide. Head brown, smooth, without horns (as present in *Ceratoglyphina*, *Ceratovacuna*, *Pseudoregma* and some *Astegopteryx* species), lacking a group of 6-15 hairs, 4-10  $\mu$  long, on each side of the head (as occurs in *Astegopteryx* from *Styrax*); but ventrally or lateral to the median ocellus a pair of sturdy hairs, 6-20  $\mu$  long and 2-3  $\mu$  wide at the base. Antennae with five segments, 0.35-0.61 times as long as the body, and 1.4-2.2 times the width of the head across the eyes, the tip of the last segment distal to the ultimate rhinarium 20-40  $\mu$  long. Antennal segments III-V with ring-shaped secondary rhinaria; between the rhinaria 2-4 concentric spinulose imbrications; the primary rhinaria moulded with the annular rhinaria to a complex structure, but those of

segment V separate; segment III with 23-49, IV with 7-15, V with 1-13 annular rhinaria. Last rostral segment 0.63-1.18 times as long as the second tarsal segment of the hind leg; length of the stylets 270-540  $\mu$ . Eyes compound. Fore wing medial vein once branched, the hind wing with two oblique veins. First tarsal segment with four hairs, of the midleg with 3-4, of the hind leg with two. Second tarsal segment of the hind leg with one or two dorsoapical hairs with expanded tips. Abdominal segments I-V or I-VI colourless, VI colourless or with a pair of pale brown patches; tergite VII with a transversely elongate pale brown plate, sometimes united with a pale brown marginal sclerite, or with two pale brown patches only; VIII with a transverse elongate pale brown plate; tergite IV with 4-10 hairs, 24-43  $\mu$  long, VIII with 3-12 hairs, 29-71  $\mu$  long. Siphunculi located on tergite IV or V, colourless, pale brown, or posteriorly with one or two pale brown patches, with 2-10 hairs. Cauda transversely elongate without or with a rather indistinct constriction, the base 104-161  $\mu$  wide, the knob, if observable 59-74  $\mu$ , with 8-13 hairs, the longest 26-69  $\mu$ . Subanal plate bilobed, with 12-26 hairs, the longest 31-71  $\mu$ . Subgenital plate with 2-9 anterior, and 5-18 posterior hairs. Gonapophyses two, each with 4-10 hairs, the longest 9-25  $\mu$ .

Embryos in alatae are similar to those in apterae, but in *R. macrosoleni* embryos in alatae with two sturdy hairs anteriorly on the head 8-13  $\mu$  long and dorsal hairs blunt, 6-12  $\mu$  long; in first stage larvae of apterae these anterior hairs are 16  $\mu$  long, the dorsal 30  $\mu$ ; in *R. plicator* also alatae with embryos with shorter hairs than in apterae.

Etymology.— Rappardiella, small Rappard, name Dr D. Hille Ris Lambers intended to give to this genus to commemorate Dr F.W. Rappard of the Forestry Service of Indonesia, who collected much material of species of this genus on Java.

**Rappardiella cerina** spec. nov.  
(figs. 432-439)

Types.— Holotype (apterous viviparous female) from *Dendrophthoë pentandra* (L.) Miq., Sindanglaya (1100 m), 30.xi.1977, leg. D. Noordam, no. 1152-17-1. Paratypes: apterae viviparae, about 275 specimens on 41 slides with the same data as the holotype. Holotype and paratypes in the collection at the Rijksmuseum van Natuurlijke Historie, Leiden.

Apterous viviparous female.— In life (pl. 45): Body yellowish white with a soft mixture of reddish brown. Antennae distally grey. Legs, the knees slightly pale red, the tarsi distally grey. Siphunculi pale orange. Eyes black. The body, antennae and legs covered with a dull, but transparent layer of wax; this layer turns white when broken. Threads or columns of white wax are completely lacking.

Macerated specimens.— (figs. 432-437; described from 10 specimens). Body 1.08-1.30 mm long, 1.2-1.5 times as long as it is wide, the margins of the sclerotic dorsal side cover the flat venter with a rim.

Head.— Head very pale brown, with pustules having an irregular, oval or more or less star-shaped outline, with dotted surface, and a diameter of 6-10  $\mu$ , and 1-2  $\mu$  high, most distinct at the frons, near to the eyes and along a median suture. Frons between the antennae slightly protruding in the middle, but between the ventral horns bending inwards 4-6  $\mu$ . Head across the eyes 354-425  $\mu$  wide. A pair of horns

(fig. 434) located about 20  $\mu$  ventral to the antennae e.g. 20  $\mu$  long and 45  $\mu$  wide at the base, with broadly rounded tips bearing one hair on the tip which has a base eight  $\mu$  long, and 10  $\mu$  wide, the hair 12-17  $\mu$  long, and four  $\mu$  wide at the base; anteriorly at the base of the horn usually one normal hair is present. Head anterior and dorsal to the horns with six anterior hairs, the two most ventral more sturdy than the others; between the eyes an anterior and a posterior row each with four or rarely five hairs, 23-30  $\mu$  long. Wax glands are lacking. Antennae with five segments, very pale brown, 287-342  $\mu$  long, 0.25-0.29 times as long as the body, 0.74-0.93 times the width of the head across the eyes, and 1.5-1.6 times as long as the tibia of the fore leg; segments I and II almost smooth, III with sparse spinulae, 2-4  $\mu$  long, IV with more spinulae also on distinct imbrications, V with spinulose imbrications, the spinulae 2-6  $\mu$  long; segment III, 86-108  $\mu$  long, 1.7-1.9 times as long as IV, 1.0-1.3 times as long as V, with 2-6 hairs, 20-23  $\mu$  long; IV, 49-67  $\mu$  long, 0.6-0.7 times as long as V, usually with two hairs, but sometimes with one; V, 82-89  $\mu$  long, the processus terminalis 20-25  $\mu$  long, with one hair and five apical setae. Eyes (fig. 435) slightly darker than the head, the anterior and medial side the same height as the dorsum, but the outer and posterior side an almost perpendicular wall, about 20  $\mu$  above the margin of the head, with three ommatidia, 12-14  $\mu$  diameter. Ultimate rostral segment (fig. 436) 72-84  $\mu$  long, 0.96-1.04 times as long as the second tarsal segment of the hind leg; stylets 380-415  $\mu$  long.

Thorax.— Prothorax the same colour as the head, fused with the head, almost smooth without swellings but pleurally a groove, passing from the posterior margin forwards, to an indistinct muscle plate, 5-20  $\mu$  deep, and sometimes with a median suture; pustules present, but indistinct; on each side two hairs, and two hairs dorsally. Mesothorax separate, pale brown, almost smooth, on each side with two marginal hairs, and 3-7 dorsal hairs. Metathorax as mesothorax but with 3-5 dorsal hairs. Legs almost evenly very pale brown, smooth, but the second tarsal segments with some imbrications with a few spinulae. Tibia of the fore leg 181-220  $\mu$  long, 0.48-0.58 times as long as the width of the head across the eyes. First tarsal segments of the fore leg with four hairs, the lateral 2.9-3.5 times as long as the middle hairs, of the midleg with three hairs, of the hind leg with two hairs, 40-49  $\mu$  long. Second tarsal segments of the hind leg 0.25-0.27 times as long as the tibia of the hind leg, and 0.18-0.2 times as long as the width of the head across the eyes, with two dorsoapical hairs expanded at the tips, 37-45  $\mu$  long, the tip 3-4  $\mu$  wide. Empodial hairs of the hind leg 22-29  $\mu$  long. Length of the segments of the hind leg: femur plus trochanter 263-314  $\mu$ , tibia 263-318  $\mu$ , 0.97-1.05 times as long as the femur, and 0.69-0.81 times the width of the head across the eyes, first tarsal segment 33-37  $\mu$ , second tarsal segment 72-86  $\mu$ .

Abdomen.— Abdomen margins and dorsum very pale brown, segments I-VI fused, sclerotic, without segmental borders and without borders between margins and dorsum, the margin of the sclerotic segments I-VI located ventrally, with oval pustules 8-12  $\mu$  diameter, best observable at bends in the skin. Without wax gland groups. Tergite I with 4-5 hairs, II with 4-5; III, 3-5; IV between the siphunculi, and siphuncular hairs not included, 2-5; V, 2-4; VI, 2-3; length of hairs on tergite IV, 27-40  $\mu$ , ventrally on IV, 25-30  $\mu$ . Tergite VII with segmental borders, with pustules and spinulose imbrications, with two or rarely three hairs. Tergite VIII with a transverse elongate plate, e.g. 285  $\mu$  wide, and 53  $\mu$  long, the anterior side rounded, the posterior margin emarginate, with spinulose imbrications, and 6-8 hairs, 30-45  $\mu$  long, without wax glands. S-shaped wax glands observable on the ventral side only. Siphunculi



located dorsally on segment IV, same colour as the surroundings, a cone e.g. 150  $\mu$  long, 80  $\mu$  wide, and 30-35  $\mu$  high, with more or less concentrically arranged wrinkles and pustules, with 2-7 hairs; pore yellowish brown, the margin of the pore about 0-40  $\mu$  from the margin of the abdomen, diameter of the pore 27-33  $\mu$ , with a rim about 4  $\mu$  wide. Cauda (fig. 437) transversely elongate, without a constriction, e.g. 125  $\mu$  wide at the base and 35  $\mu$  long; at the base 94-125  $\mu$  wide, with 8-12 hairs, the longest 39-47  $\mu$ . Subanal plate bilobed, with 12-16 hairs, the longest 45-57  $\mu$ . Subgenital plate with 2-12 anterior hairs on the plate, 35-49  $\mu$  long, and 10-15 hairs along the posterior margin, 25-40  $\mu$  long. Gonapophyses two, each with 4-7 hairs, the longest 19-23  $\mu$ .

First stage larva of apterous viviparous female (figs. 438, 439; description of one specimen). Body length 663  $\mu$ , length of head plus pronotum 206  $\mu$ , 0.70 times the width of the prothorax; width of the head across the eyes 244  $\mu$ . The head dorsally, and dorsal to the horns (fig. 439) with six hairs, the two just anterior to the horns somewhat more sturdy and with a stouter base than the other hairs; two rows each of four hairs between the eyes, 25-27  $\mu$  long; horns ventrally, not well-defined, with one hair, the base of the hair six  $\mu$  long, eight  $\mu$  wide, and the hair 12  $\mu$  long, and four  $\mu$  wide at the basal part. Antennae with five segments, 271  $\mu$  long, segment II with a few spinulae and a hair, 24  $\mu$  long, III-V with distinct spinulose imbrications, III, 69  $\mu$  long, without hairs; IV, 47  $\mu$  long, with two hairs, 24  $\mu$  long; V, 90  $\mu$  long, the process terminalis 35  $\mu$ . The last rostral segment 78  $\mu$  long, 0.97 times as long as the second tarsal segment of the hind leg. The tibiae, first tarsal segments and second tarsal segments of the legs with spinulose imbrications; tibia of the fore leg 179  $\mu$  long, 0.73 times as long as the width of the head across the eyes; length of distal hairs of the hind tibia 40  $\mu$ . All first tarsal segments with two hairs, of the hind leg 53  $\mu$  long. Two dorsoapical hairs of the second tarsal segment with expanded tips, 42  $\mu$  long, the other apical hairs less sturdy. Wax gland groups are lacking, but more or less oval pustules are observable, distinctly on the head and margins of the body, but indistinctly on other parts of the body. Abdominal tergites I-III each with four hairs, IV-VIII with two, on VIII, 35  $\mu$  long. Cauda with two hairs, 37  $\mu$  long. Siphunculi present, the pore 20-21  $\mu$  wide.

Host plant records.— Specimens were collected in Java from *Dendrophthoë pentandra* (L.) Miq., Sindanglaya (1100 m), 30.xi.1977, leg. D. Noordam, in the collection at the Rijksmuseum van Natuurlijke Historie, Leiden.

The aphids live pressed close to the downward curved or rolled up leaves, with ants; wax and honey dew was lacking between the aphids. Usually one half of a leaf is rolled up in length, the other half being curved downwards only; the leaves that have been attacked the longest are lumpy with only the margins curved downwards.

Alatae or larvae of alatae were not collected.

Etymology.— Cerina, waxy yellow, dull yellow, with a soft mixture of reddish brown.

**Rappardiella loranthi** (Van der Goot, 1917) comb. nov.  
(figs. 440-450)

*Oregma loranthi* Van der Goot, 1917: 194.

*Tuberaphis loranthi*; Eastop & Hille Ris Lambers, 1976: 439 (classification).

Types.— Lectotype (apterous viviparous female, here designated) from *Loranthus* spec., Salatiga, 24.x.1915, leg. P. van der Goot, no. 14-2-1. Paralectotypes: apterae viviparae, 12 specimens with the same data as the lectotype. Lectotype and paralectotypes in the collection at the Laboratorium voor Entomologie, Wageningen.

The specimens of this species cannot be cleared up using either KOH or chloral phenol but remain filled with a black non-transparent coagulum, and the skin of the specimens breaks into pieces when trying to remove this coagulum. Only rarely are a few specimens sufficiently transparent to observe the characteristics of this species. Original material collected by Van der Goot (1917) is preserved, and is chosen as lectotype and paralectotypes, it is only partly suitable for observations.

Apterous viviparous female.— In life (pl. 46): Orange, sometimes more violet, with on each segment three or four darker patches, which disappear in alcohol. The head also orange, eyes black. Antennae same colour as the body, the last segment pale greyish brown. Legs pale greyish brown; siphunculi pale brown, the pore a darker ring.

Head, thorax and abdomen covered with a rather thin granular to flaky cover of wax, not covering segmental borders with muscular plates; along the border of the body from head to about the siphunculi tiny columns of wax, not higher than 50  $\mu$ . Smallest larvae yellowish with darker spots, head, antennae and legs greyish brown, with greyish brown siphunculi, extending more than in adult specimens.

Macerated specimens.— (figs. 440-443; described from three, and partly from four other specimens). Body 1.50-2.07 mm long, 1.2-1.6 times as long as it is wide.

Head.— Head pale brown, with pustules having a diameter of 10-20  $\mu$ , with somewhat irregular facets, 2-3  $\mu$  wide. Frons curved, but between the antennae and horns straight. Head across the eyes 374-472  $\mu$  wide. A pair of horns (fig. 441) located ventrally, medial to the antennae, e.g. 33  $\mu$  long, and 45  $\mu$  wide at the base, with broadly rounded tips, bearing one hair on the tip, which has a process 10  $\mu$  wide and 8  $\mu$  high, the hair 18-25  $\mu$  long, and 4-6  $\mu$  wide at the base. Frons anterior and dorsal to the horns with 8-9 hairs, the most ventral hairs more sturdy than the others; between the eyes an anterior row with usually four hairs, and a posterior row with 4-10 hairs, 78-96  $\mu$  long. Wax glands medial to the eyes number 0-4, diameter 14-18  $\mu$ ; the glands have a thicker margin than the pustules, and the diameter of the facets is 6-8  $\mu$ . Antennae with five segments, pale brown, the last segment darker, 478-590  $\mu$  long, 0.27-0.35 times as long as the body, 1.1-1.5 times the width of the head across the eyes, and 1.3-1.8 times as long as the tibia of the fore leg; segments I and II with some longitudinal wrinkles, III-V with spinulose imbrications, the spinulae 2-8  $\mu$  long; segment III, 170-238  $\mu$  long, 2.3-2.8 times as long as IV, 1.3-1.7 times as long as V, with 4-7 hairs, 47-57  $\mu$  long; IV, 70-102  $\mu$  long, 0.5-0.7 times as long as V, with 1-2 hairs; V, 125-151  $\mu$  long, the processus terminalis 27-45  $\mu$  long, with one hair and five apical setae. Eyes (fig. 442) brown, a rectangular structure as observed from the dorsal side, with parallel anterior and posterior sides and straight outer margin, protruding from the head 22-29  $\mu$ , with three ommatidia, 12-16  $\mu$  diameter. Ultimate rostral segment 110-123  $\mu$  long, 1.00-1.06 times as long as the second tarsal segment of the hind leg; stylets 550-680  $\mu$  long.

Thorax.— Prothorax the same colour as the head, fused with the head, with a distinct groove running posterior to the eyes in the posteromedial direction; pleurally a groove passing from the posterior margin forward, and a median groove; the lat-

eral margins with a longitudinal row of 7-10 wax glands, and pustules; spinally pustules, and two groups of 7-9 wax glands; on each side two hairs, and 4-6 hairs dorsally. Meso- and metathorax pale brown, on each side the mesothorax with a longitudinal row of 6-9 wax glands, the metathorax with 4-6, spinal wax glands are lacking; each segment dorsally with 19-26 hairs. Legs evenly pale brown, slightly darker than the body, smooth, but the second tarsal segments with a few spinulae. Tibia of the fore leg 297-354  $\mu$  long, 0.68-0.81 times as long as the width of the head across the eyes. First tarsal segments of the fore- and midleg with four hairs, the lateral 2.2-2.4 times as long as the middle hairs, of the hind leg with two hairs, 47-53  $\mu$  long. Second tarsal segments of the hind leg 0.23-0.26 times as long as the tibia of the hind leg, and 0.25-0.29 times as long as the width of the head across the eyes, with two dorsoapical hairs expanded at the tips, 59-67  $\mu$  long, the tip 2-3  $\mu$  wide. Empodial hairs of the hind leg 35-37  $\mu$  long. Length of the segments of the hind leg: femur plus trochanter 342-425  $\mu$ , tibia 386-527  $\mu$ , 1.24-1.34 times as long as the femur, and 1.07-1.23 times the width of the head across the eyes, first tarsal segment 41-47  $\mu$ , second tarsal segment 113-123  $\mu$ .

Abdomen.— Abdomen margins and dorsum pale brown, segments I-VI fused, sclerotic, but dorsally between I and II a distinct transverse groove exists; between the other segments dorsal grooves are also present, but less distinct; margins and tergites with pustules, 12-30  $\mu$  diameter, with facets with a diameter of 2-5  $\mu$ , the pustules are lacking in the grooves; some spinulose imbrications on tergites IV-VI. Marginal wax glands in a longitudinal row number on each side on segments I-IV, 4-5; V, 0-4; VI, 0-5; VII, 0-3; the wax glands with a diameter of 15-30  $\mu$ , with a thickened outer margin, and facets with a diameter of 6-8  $\mu$ . Tergite I with 23-27 hairs, II with 20-30, III, 23-30; IV, 25-27; V between the siphunculi and siphuncular hairs not included 16-20; VI, 5-20; length of hairs on tergite IV, 75-102  $\mu$ , ventrally on IV, 43-63  $\mu$ . Tergite VII with segmental borders, with pustules and spinulose imbrications, pustules occurring anterior to each imbrication, with 5-9 hairs. Tergite VIII a transverse elongate plate, sometimes observed curved around the cauda and anal plate, with spinulose imbrications with faceted pustules on its anterior side, with 0-2 marginal wax glands, spinal wax glands lacking, and 6-7 hairs, 76-98  $\mu$  long. S-shaped wax glands observable on the ventral side of the abdomen. Siphunculi located dorsally on segment V, the same colour as the surroundings, a cone about 200  $\mu$  long, and 40  $\mu$  high with some concentrically arranged wrinkles, with 15-25 hairs; pore brown, close to the margin of the abdomen, diameter of the pore 68-80  $\mu$ , with a rim 4-6  $\mu$  wide. Cauda (fig. 443) with a knob with a constriction, the width of the base not well-defined, the knob e.g. 78  $\mu$  wide, 35  $\mu$  long, with a diameter of the constriction of 35  $\mu$ ; the knob 65-85  $\mu$  wide, with 8-12 hairs, the longest 40-55  $\mu$ . Subanal plate bilobed, with 14-15 hairs, the longest 45-59  $\mu$ . Subgenital plate with 2-3 anterior hairs, 40-63  $\mu$  long, and 10-11 posterior hairs, the longest 33-55  $\mu$ . Gonapophyses two, each with 5-8 hairs, the longest 12-15  $\mu$ .

Alate viviparous female.— In life: Head and thorax black, abdomen dull dark brown. Eyes black. Antennae black. Legs greyish brown. Siphunculi with dark pore. Cauda dark brown. Pterostigma greyish black (Van der Goot, 1917).

Macerated specimens.— (figs. 444-450; one specimen, some fragments and data of Van der Goot, 1917). Body length 1.6-2.5 mm, 2.0-2.3 times as long as it is wide.

Head.— (fig. 444). Head brown, smooth, width across the eyes 470-485  $\mu$ ; anteri-

or to the paired ocelli, and dorsal (fig. 445) to the median ocellus 5-6 hairs all of normal shape, 20-25  $\mu$  long, but ventrally, lateral to the median ocellus a pair of hairs (fig. 445) 12-20  $\mu$  long, and 2  $\mu$  wide at the base; these hairs are more sturdy than the dorsal hairs. Antennae brown, with black rings, with five segments 860-1000  $\mu$  long, 0.40-0.52 times as long as the body, and 1.8 times the width of the head across the eyes; segment I with some longitudinal wrinkles, segment II with longitudinal wrinkles and ventrally also with some spinulae; segments III-V (figs. 446) with ring-shaped secondary rhinaria, the rings are not closed on the dorsal side, with a space of 2-20  $\mu$ ; between the rhinaria are 2-4 concentric spinulose imbrications, dorsally and ventrally with interconnections; the rhinaria are 3-4  $\mu$  wide. The primary rhinarium of segment IV dorsally with an annular rhinarium on the ventral side, that of segment V located distally, dorsally and somewhat ventrally, up to 14  $\mu$  wide, with some circular accessory rhinaria close by; segment III with 40-42 annular rhinaria, IV with 12-15, V with 10-11; hairs of segment III, 12-19  $\mu$  long. Length of segment III, 440  $\mu$ , 2.9 times as long as IV, 2.4 times as long as V; segment IV, 150  $\mu$  long, 0.8 times as long as V; V, 180  $\mu$  long, the processus terminalis 40  $\mu$ . The last rostral segment (fig. 447) 111-116  $\mu$  long, 0.85-0.86 times as long as the second tarsal segment of the hind leg, without accessory hairs; length of the stylets 520-540  $\mu$ . Eyes compound.

Thorax.— The mesothorax brown or black. Fore wing (like fig. 490) medial vein once branched, the hind wing with two oblique veins. Legs brown, the tibiae and tarsi with some spinulae; the tibia of the fore leg 460  $\mu$  long, 0.95 times as long as the width of the head across the eyes, length of hairs of the hind tibia 30  $\mu$ ; chaetotaxy of first tarsal segments (fig. 448) 4, 4, 2, the lateral hairs of the fore tarsus 2.2 times as long as the middle; length of the hairs of the first tarsal segment of the hind leg 47  $\mu$ ; the second tarsal segment of the hind leg with one dorsoapical hair with an expanded tip, 55  $\mu$  long, the tip 3  $\mu$  wide; length of the empodial hair of the hind leg 35  $\mu$ . Length of the hind segments: femur fused with trochanter 425-445  $\mu$ , tibia 606-637  $\mu$ , 1.43 times as long as the femur, and 1.29-1.31 times the width of the head across the eyes; first tarsal segment 39  $\mu$  long, second tarsal segment 130-135  $\mu$ .

Abdomen.— (fig. 449). Abdominal segments I-VI colourless, VII a pale brown transverse elongate plate, smooth; VIII a pale brown plate, with a curved anterior margin and a straight posterior margin, with spinulose imbrications; tergite IV with 10 hairs, the siphuncular hairs not included; V, 11; VI, five; VII, five; VIII, 7-9; hairs on tergite IV, 33  $\mu$  long; on VIII, 37  $\mu$ . Siphunculi located on tergite V, colourless, with 6-7 hairs, the pore yellowish, 55-59  $\mu$  wide. Cauda (fig. 450) at the base 104-125  $\mu$  wide, the knob 59-72  $\mu$  wide, with 10-12 hairs, the longest 40  $\mu$ . Subanal plate bilobed, with 14-18 hairs, the longest 45  $\mu$ . Subgenital plate with two anterior hairs, 40  $\mu$  long, and 16 posterior hairs, the longest 53  $\mu$ . Gonapophyses two, each with 6-7 hairs, the longest 16-18  $\mu$ . Spiracles on seven abdominal segments, I-VII.

Embryos in alatae presumably as first stage larvae of apterae.

Host plant records.— Specimens were collected in Java: on *Loranthus* spec., Salatiga (600-800 m), 24.x.1915, leg. P. van der Goot, no. 14, and without data no. 260, in the collection at the Laboratorium voor Entomologie, Wageningen; *Scurrula* spec., Sumber-Wringin (800 m), 4.ix.1950, leg. F.W. Rappard, no. 236, in the collection at the British Museum (Natural History), London; *Scurrula korthalsii* (Molkenb.) Dans., Sindanglaya (1100 m), 1.xii.1977, leg. D. Noordam, in the collection at the Rijksmuseum van Natuurlijke Historie, Leiden.

The aphids live on old leaves, and very densely on lignified branches of *Scurrula* species. Presumably *Loranthus* spec. of Van der Goot also was a *Scurrula* species.

Alatae were collected 24.x.1915 and by Van der Goot without date, no. 260.

Etymology.— *Loranthi*, of *Loranthus*; the name was given by Van der Goot (1917).

**Rappardiella macrosoleni spec. nov.**  
(figs. 451-466)

Types— Holotype (apterous viviparous female) from *Macrosolen cochinchinensis* (Lour.) Tiegh., Bogor, Kebun Raya, 31.x.1977, leg. D. Noordam, no. 1082-7-10. Paratypes: apterae viviparae, 55 specimens, and 69 alate viviparous females from the same plant species and at the same place as the holotype, no. 1082, and no. 410, 14.xi.1975; no. 769, 28.xi.1976; no. 833, 23.xii.1976, all leg. D. Noordam. Holotype and paratypes in the collection at the Rijksmuseum van Natuurlijke Historie, Leiden.

Apterous viviparous female.— In life (pl. 47): Body brown, antennae and legs pale brown, eyes black. The dorsum covered with a thin layer of flaky wax, also on antennae and legs; a woolly horseshoe-shaped cushion passes the border from metathorax and around the last abdominal segment, up to 0.5 mm wide, even covering the siphunculi, but sometimes interrupted spinally and more narrow on the last abdominal segment. Larvae with less wax and the siphunculi more visible.

Macerated specimens.— (figs. 451-455; described from 11 specimens). Body 1.34-1.58 mm long, 1.5-1.7 times as long as it is wide.

Head.— Head pale brown, smooth without dotted surface. Frons between the base of the antennae straight or protruding, e.g. not more than six  $\mu$  over the width of 150  $\mu$ . Head across the eyes 355-415  $\mu$  wide. Horns absent, but ventrally lateral to the median suture two pairs of dagger hairs (fig. 452), the frontal with a base 10-12  $\mu$  wide, 6-8  $\mu$  high with a hair 12-20  $\mu$  long, and 4  $\mu$  wide at the base; the two posterior dagger hairs are sometimes less sturdy, but longer than the anterior hairs. The head anterior to the eyes and dorsal to the dagger hairs with 5-8 hairs, between the eyes an anterior and a posterior row, each of four hairs, 23-31  $\mu$  long. Wax glands are lacking. Antennae with five segments, pale brown, 456-540  $\mu$  long, 0.31-0.40 times as long as the body, 1.1-1.5 times the width of the head across the eyes, and 1.7-1.9 times as long as the tibia of the fore leg; segment I smooth, II smooth with some longitudinal wrinkles and a few spinulae, III-V with spinulose imbrications, the spinulae 2-4  $\mu$  long; segment III, 161-210  $\mu$  long, 1.8-2.1 times as long as IV, 1.3-1.5 times as long as V, with 3-6 hairs, 18-29  $\mu$  long; IV, 80-100  $\mu$  long, 0.6-0.7 times as long as V, with 1-2 hairs; V, 123-143  $\mu$  long, the processus terminalis 25-30  $\mu$  long, with one hair, and five apical setae. Eyes (fig. 453) brown, the anterior and medial side at the same height as the dorsum, but the outer and posterior side an almost perpendicular wall, 20-40  $\mu$  above the margin of the head, with three ommatidia, 13-14  $\mu$  diameter. Ultimate rostral segment (fig. 454) 76-86  $\mu$  long, 0.68-0.78 times as long as the second tarsal segment of the hind leg; stylets 325-380  $\mu$  long.

Thorax.— Prothorax the same colour as the head, fused with the head, smooth or with rather indistinct s-shaped structures, pleurally without a groove at the posterior margin, and without swellings, with a median suture; on each side two hairs, and

dorsally two hairs; wax glands are lacking. Mesothorax pale brown, a segmental border between the prothorax, but a border between meso- and metathorax is lacking; on each side two marginal hairs, dorsally 7-8 hairs. Metathorax as mesothorax, but with 6-8 dorsal hairs. Legs almost evenly pale brown, smooth, but the second tarsal segments with some spinulose imbrications. Tibia of the fore leg 271-310  $\mu$  long, 0.68-0.85 times as long as the width of the head across the eyes. First tarsal segments of the fore leg with four, rarely with three hairs, the lateral 2.0-2.9 times as long as the middle hairs, of the midleg with three hairs, of the hind leg with two hairs, 48-57  $\mu$  long. Second tarsal segments of the hind leg 0.28-0.30 times as long as the tibia of the hind leg, and 0.25-0.32 times as long as the width of the head across the eyes, with two dorsoapical hairs expanded at the tips, 44-52  $\mu$  long, the tip two  $\mu$  wide. Empodial hairs of the hind leg 25-31  $\mu$  long. Length of the segments of the hind leg: femur plus trochanter 346-393  $\mu$ , tibia 350-397  $\mu$ , 1.01-1.06 times as long as the femur, and 0.89-1.10 times the width of the head across the eyes, first tarsal segment 41-43  $\mu$ , second tarsal segment 102-118  $\mu$ .

Abdomen.— Abdomen evenly pale brown as the head, segments fused, no distinct border between metathorax and abdominal segment I, and only an indistinct border between segments VII and VIII, the skin dorsally with rather indistinct lines somewhat as convolutions of the brain, ventrally s-shaped wax glands running parallel to each other; wax gland groups are lacking. Tergites I-IV each with 5-8 hairs; V between the siphunculi, and siphuncular hairs not included 4-7; VI, 3-5, VII with spinulose imbrications and 2-4 hairs; length of hairs on tergite IV, 25-39  $\mu$ , ventrally on IV, 25-37  $\mu$ . Tergite VIII with spinulose imbrications, with 6-10 hairs, 30-40  $\mu$  long. Siphunculi located dorsally on segment V, same colour as the surroundings, flat, with some concentrically arranged lines or network, with 3-4 hairs; pore yellowish, the margin about 5-25  $\mu$  from the margin of the abdomen, diameter of the pore 42-50  $\mu$ , without a rim. Cauda transversely elongate, without a constriction, e.g. 175  $\mu$  wide at the base, and 58  $\mu$  long; at the base 140-182  $\mu$  wide, with 8-12 hairs, the longest 40-43  $\mu$ . Subanal plate bilobed, with 12-15 hairs, the longest 37-50  $\mu$ . Subgenital plate with 2-5 anterior hairs on the plate, 25-45  $\mu$  long, and 10-14 hairs along the posterior margin, 25-45  $\mu$  long. Gonapophyses two, each with 1-6 hairs, the longest 6-10  $\mu$ .

Alate viviparous female.— In life: Wholly black. Pterostigma black or greenish black. Without wax.

Macerated specimens.— (figs. 456-464; described from 10 specimens). Body length 1.28-1.72 mm, 1.3-1.7 times as long as it is wide.

Head. (figs. 456-458).— Head brown, smooth, dots sometimes observable, width across the eyes 400-456  $\mu$ ; anterior to the paired ocelli, and dorsal to the median ocellus 6-10 hairs, the two nearest the median ocellus more sturdy and shorter than the others, 6-10  $\mu$  long, 2-3  $\mu$  wide at the base; posterior to the paired ocelli four hairs, 14-16  $\mu$  long. Antennae brown, with black rings, with five segments 695-820  $\mu$  long, 0.45-0.61 times as long as the body, and 1.7-2.0 times the width of the head across the eyes; segment I somewhat wrinkled, segment II with some longitudinal wrinkles, and dorsally and ventrally with spinulose imbrications, the spinulae 1-3  $\mu$  long; segments III-V (fig. 457) with ring-shaped secondary rhinaria, the rings are not closed on the dorsal side, with a space of 4-30  $\mu$ ; between the rhinaria are usually three concentric spinulose imbrications, dorsally and ventrally with interconnections; the rhi-

naria are 3-4  $\mu$  wide. The primary rhinarium of segment IV moulded with a secondary rhinarium to a complex structure, but that of segment V well distinguished from annular rhinaria; segment III with 30-44 annular rhinaria, IV with 10-15, V with 9-13; hairs of segment III, 10-16  $\mu$  long. Length of segment III, 314-385  $\mu$ , 2.2-2.7 times as long as IV, 1.9-2.3 times as long as V; segment IV, 126-160  $\mu$  long, 0.8-1.0 times as long as V; V, 159-181  $\mu$  long, the processus terminalis 20-29  $\mu$ . The last rostral segment (fig. 458) 73-81  $\mu$  long, 0.63-0.72 times as long as the second tarsal segment of the hind leg, without accessory hairs; length of stylets 270-325  $\mu$ . Eyes compound, the ocular tubercle extending sideways about 20  $\mu$ .

Thorax.— Sides of the prothorax pale brown, the mesothorax brown. Fore wing (figs. 459, 460) medial vein once branched, the hind wing with two oblique veins. Legs brown, femur and tibia dorsally in the neighbourhood of the knee slightly darker, femora almost smooth, tibiae with some spinulose imbrications, especially distally, second tarsal segments with spinulose imbrications; the tibia of the fore leg 385-430  $\mu$  long, 0.90-1.02 times as long as the width of the head across the eyes, length of hairs of the hind tibia 33-43  $\mu$ ; chaetotaxy of first tarsal segments 4, 3-4, 2, the lateral hairs of the fore tarsus (fig. 461) 2.5-3.2 times as long as the middle; length of hairs of the first tarsal segment of the hind leg 50-61  $\mu$ ; the second tarsal segment of the hind leg (fig. 462) with two dorsoapical hairs with expanded tips, 41-47  $\mu$  long, the tip three  $\mu$  wide; length of the empodial hair of the hind leg 25-33  $\mu$ . Length of the hind segments: femur fused with trochanter 370-437  $\mu$ , tibia 472-559  $\mu$ , 1.22-1.30 times as long as the femur, and 1.12-1.29 times the width of the head across the eyes; first tarsal segment 35-41  $\mu$  long, second tarsal segment 103-117  $\mu$ .

Abdomen.— (fig. 463). Abdominal segments I-VI colourless, VII margins and dorsum with a pale brown plate, the anterior and posterior margins may be colourless, with some spinulose imbrications; VIII pale brown, with a curved anterior margin, and emarginate at the posterior margin, pleurally with a denticle 2-4  $\mu$  high, with spinulose imbrications; tergite III with 5-8 hairs; IV, 7-8; V, 3-7, the siphuncular hairs not included; VI, 2-5; VII, 2-4; VIII, 6-10; hairs dorsally on segment IV, 23-29  $\mu$  long, ventrally 25-31  $\mu$ ; on tergite VIII, 30-40  $\mu$ . Siphunculi located on tergite V, a pore 35-40  $\mu$  wide, eight  $\mu$  high, outside the pore colourless with, on the posterior side, usually one or two pale brown patches 8-25  $\mu$  wide, around the pore 2-5 hairs. Cauda (fig. 464) broadly rounded without a constriction 128-160  $\mu$  wide at the base, and about 50  $\mu$  long, with 10-13 hairs, the longest 26-39  $\mu$ . Subanal plate bilobed, with 12-16 hairs, the longest 31-41  $\mu$ . Subgenital plate with 5-9 anterior hairs, the longest 27-35  $\mu$ , and 11-15 hairs along the posterior margin, the longest 31-43  $\mu$ . Gonapophyses two, each with 4-7 hairs, the longest 9-16  $\mu$ . Spiracles on seven abdominal segments, I-VII.

First stage larva of apterous viviparous female (figs. 465, 466; description of one specimen). Body length 685  $\mu$ , length of head plus pronotum 200  $\mu$ , 0.75 times the width of the prothorax; width of the head across the eyes 226  $\mu$ ; the head ventrally close to the median suture with a pair of hairs (fig. 466) more sturdy than the other hairs of the head, 16  $\mu$  long and 3  $\mu$  wide near the base; dorsal to these hairs four hairs, and anterior and posterior to the eyes a row of four hairs, 30  $\mu$  long. Antennae with five segments, 240  $\mu$  long, segment II smooth, with a hair 23  $\mu$  long, segment III, 53  $\mu$  long, smooth with a few spinulae; IV, 41  $\mu$  long with spinulose imbrications and 2-3 hairs, about 25  $\mu$  long; V, 84  $\mu$  long with a processus terminalis 27  $\mu$  long,

with spinulose imbrications, one hair, and five apical setae, 20  $\mu$  long. The last rostral segment 74  $\mu$  long, 0.78 times as long as the second tarsal segment of the hind leg. The segments of the legs almost smooth; tibia of the fore leg 200  $\mu$  long, 0.88 times as long as the width of the head across the eyes; length of distal hairs of the hind tibia 45  $\mu$ . All first tarsal segments with two hairs, of the hind leg 55  $\mu$  long. Two dorsoapical hairs of the second tarsal segment with expanded tips, 65  $\mu$  long, the other apical hairs less sturdy. Wax gland groups are lacking, surface of the body smooth with only some spinulose imbrications on the last abdominal segments. Abdominal segments I-V each with four hairs, VI-VIII with two, on VIII, 35  $\mu$  long. Cauda with two hairs, 33  $\mu$  long. Siphunculi present, the pore 23  $\mu$  wide. The specimens contain a larger or smaller quantity of symbionts.

Embryos in alatae look like first stage larvae of apterae, but hairs are shorter, the two more sturdy hairs ventrally on the head 8-13  $\mu$ , hairs dorsally on the head, thorax and anterior abdominal segments 6-12  $\mu$ , and on the posterior abdominal segments 11-16  $\mu$ .

Host plant records.— Specimens were collected in Java: on an undetermined parasitic plant, indicated as *Loranthus* spec. (but see comments on this some lines further down), leaf galls, Tjisoeroepan, Papandajan (1220 m), 21.ix.1914, 21.viii.1916, leg. P. van der Goot in the collection at the Laboratorium voor Entomologie, Wageningen and at the British Museum (Natural History), London; *Macrosolen cochinchinensis* (Lour.) Tiegh., Bogor, Kebun Raya, 14.xi.1975, 23.xii.1976, 31.x.1977, and Bogor, 28.ix.1976, leg. D. Noordam, in the collection at the Rijksmuseum van Natuurlijke Historie, Leiden.

The aphids live in leaf galls, the lamina of the leaves are lengthwise rolled inwards and upwards, and aphids can leave the galls through a narrow slit. The galls are described by Docters Van Leeuwen-Reijnvaan and Docters Van Leeuwen 1926: 169, gall no. 346 on *Elytranthe globosa* Engl., a synonym of *Macrosolen cochinchinensis*. Van der Goot (unpublished) also gives a description of the galls, and these galls are so characteristic that there is no doubt that his *Loranthus* spec. was *Macrosolen cochinchinensis*.

Alatae were collected 21.viii.1916, 28.ix.1976, and 31.x.1977.

Etymology.— *Macrosoleni*, from *Macrosolen* Bl., a genus of the Loranthaceae.

### ***Rappardiella plicator* spec. nov.**

(figs. 467-481)

Types.— Holotype (apterous viviparous female) from *Scurrula* spec., Rembangan, 2.ix.1950, leg. F.W. Rappard, no. 235a-5-1. Paratypes: apterae viviparae, about 60 specimens, and alatae viviparous females, 11 specimens, on eight slides with the same data as the holotype, no. 235a and 235. Holotype and paratypes in the collection at the British Museum (Natural History), London.

Apterous viviparous female.— In life: Body blue like grapes, antennae and legs colourless, siphunculi not observable; young specimens without wax, but later the sides of the abdomen with white wax, and the dorsum sometimes with a faintly observable longitudinal row of, on each segment, one patch of wax; a few specimens wholly white with wax, and here and there with raised threads of wax (Dr F.W.



Rappard, unpublished).

Macerated specimens.— (figs. 467-470; described from six specimens). Body 1.18-1.43 mm long, 1.2-1.5 times as long as it is wide.

Head.— Head pale brown, with flat pustules (fig. 469) with an irregular outline, with a diameter of 7-12  $\mu$ , dotted or with indistinct facets. Frons between the base of the antennae protruding slightly, not more than 6-10  $\mu$  over the width of 140  $\mu$ . Head across the eyes 342-375  $\mu$  wide. Horns absent, but ventrally, lateral to the median suture usually a pair of sturdy hairs (fig. 468), 10-25  $\mu$  long, 2-4  $\mu$  wide near the base, on a process with a diameter of 8-12  $\mu$ ; 28 specimens were observed and one or rarely both sturdy hairs may be replaced by longer hairs, but with a process similar to that of the sturdy hairs; also 2-3 other hairs may have a process 7-10  $\mu$  wide, while the process of normal dorsal hairs is six  $\mu$  wide, and of ventral hairs 5-6  $\mu$ . Dorsally between the eyes an anterior row of 4-6 hairs, and a posterior row of four hairs, 27-31  $\mu$  long. Wax glands are lacking. Antennae with five segments, pale brown, 330-420  $\mu$  long, 0.26-0.34 times as long as the body, 1.0-1.2 times the distance between the outer margins of the eyes, and 1.7-2.1 times as long as the tibia of the fore leg; segment I smooth, II almost smooth, III-V with spinulose imbrications, the spinulae 2-5  $\mu$  long; segment III, 116-155  $\mu$  long, 1.8-2.7 times as long as IV, 1.1-1.5 times as long as V, with two or rarely one hair, 16-22  $\mu$  long; IV, 55-70  $\mu$  long, 0.54-0.69 times as long as V, with two hairs; V, 90-105  $\mu$  long, the processus terminalis 18-21  $\mu$  long, with one hair, and five apical setae. Eyes brown, with three ommatidia, 12-14  $\mu$  diameter. Ultimate rostral segment (fig. 470) 116-128  $\mu$  long, 1.30-1.43 times as long as the second tarsal segment of the hind leg, the primary hairs 43-63  $\mu$  removed from the tip, 35  $\mu$  long; stylets 415-440  $\mu$  long.

Thorax.— Prothorax colourless, fused with the head, smooth, marginally only a few pustules as on the head, without pleural grooves or median suture; on each side two hairs, and dorsally two hairs; wax glands are lacking. Meso- and metathorax marginally indistinct with some pustules and each with two hairs on each side, and dorsally each with 6-9 hairs. Legs evenly pale brown, but the second tarsal segments slightly darker, smooth, with some spinulose imbrications. Tibia of the fore leg 180-210  $\mu$  long, 0.52-0.60 times as long as the distance between the outer margins of the eyes. First tarsal segments of the fore leg with four hairs, the lateral 2.4-2.7 times as long as the middle hairs; of the midleg with four, of the hind leg with two (or rarely a third shorter hair) 40-49  $\mu$  long. Second tarsal segments of the hind leg 0.31-0.34 times as long as the tibia of the hind leg, and 0.24-0.26 times as long as the distance between the outer margins of the eyes, with two dorsoapical hairs expanded at the tips, 43-49  $\mu$ , the tip two  $\mu$  wide. Empodial hairs of the hind leg 27-31  $\mu$  long. Length of the segments of the hind leg: femur plus trochanter 257-283  $\mu$ , tibia 255-302  $\mu$ , 0.99-1.07 times as long as the femur, and 0.75-0.85 the distance between the outer margins of the eyes, first tarsal segment 33-37  $\mu$ , second tarsal segment 83-96  $\mu$ .

Abdomen.— Abdomen colourless, segmental border between segments VII and VIII only slightly observable; dorsally smooth, segments VI-VIII only with a few spinulose imbrications, the margins with rather indistinct s-shaped wax glands, running parallel to each other, proceeding ventrally, but the middle ventrally with some spinulose imbrications; wax gland groups are lacking. Tergite I with 5-8 hairs, II with 5-6; III, 4-7; IV, 4-6; V, 3-4; VI two or sometimes one; VII two; VIII four; length of hairs dorsally on segment IV, 28-33  $\mu$ , ventrally 12-20  $\mu$ , on tergite VIII 37-45  $\mu$ . Siphunculi

located dorsally on segment V, same colour as the surroundings or very pale brown, 20  $\mu$  high, with concentrically arranged lines, with a diameter of 75-85  $\mu$ , with 2-4 hairs; pore yellowish, the margin 50-85  $\mu$  from the border of the abdomen, diameter of the pore 38-55  $\mu$ , without a rim. Cauda transversely elongate, without a constriction, e.g. 125  $\mu$  wide at the base and 45  $\mu$  long; at the base 96-127  $\mu$  wide, with 7-8 hairs, the longest 30-47  $\mu$ . Subanal plate bilobed, with 15-16 hairs, the longest 43-55  $\mu$ . Subgenital plate with two anterior hairs, 20-33  $\mu$  long, and 10-12 posterior hairs, 31-38  $\mu$  long. Gonapophyses two, each with 3-5 hairs, 10-16  $\mu$  long. Spiracles six on each side, on abdominal segments II-VII.

Alate viviparous female.— In life: Wholly black without wax (Dr F.W. Rappard, unpublished).

Macerated specimens.— (figs. 471-479; described from eight specimens). Body length 1.43-1.67 mm, 2.0-2.2 times as long as it is wide.

Head.— (fig. 471). Head brown, with blunt spinulae of about one  $\mu$ , width across the eyes 360-410  $\mu$ ; dorsal to the median ocellus 2-3 hairs (fig. 472), sometimes shorter and slightly more sturdy than the hairs dorsally between the eyes, an anterior and a posterior row each of four hairs, 14-18  $\mu$  long. Antennae brown, with black rings, with five segments 530-620  $\mu$  long, 0.37-0.41 times as long as the body, and 1.4-1.7 times the width of the head across the eyes; segment I somewhat wrinkled, segment II with some longitudinal wrinkles, dorsally and ventrally with spinulose imbrications, the spinulae 1-2  $\mu$  long; segments III-V (fig. 473) with ring-shaped secondary rhinaria, the rings are not closed on the dorsal side, with a space of 0-20  $\mu$ ; between the rhinaria are usually 3-4 concentric spinulose imbrications, mainly dorsally with interconnections; the rhinaria are 2-4  $\mu$  wide. The primary rhinarium of segment IV moulded with a secondary rhinarium to a complex structure, but that of segment V usually distally separate, about half a ring circumference, and the same colour as the surroundings, with some circular accessory rhinaria; segment III with 23-32 annular rhinaria, IV with 7-10, V with 1-10, the primary rhinarium included; segment III with one hair, 8-12  $\mu$  long. Length of segment III, 237-290  $\mu$ , 2.3-3.0 times as long as IV, 1.9-2.2 times as long as V; segment IV, 90-115  $\mu$  long, 0.7-0.9 times as long as V; V, 115-140  $\mu$  long, the processus terminalis 18-31  $\mu$ . The last rostral segment (fig. 474) 106-116  $\mu$  long, 1.05-1.18 times as long as the second tarsal segment of the hind leg, without accessory hairs; length of the stylets 335-372  $\mu$ . Eyes compound.

Thorax.— Sides of the prothorax pale brown, the mesothorax brown. Fore wing (fig. 475) medial vein once branched, the hind wing with two oblique veins. Legs brown, femur and tibia in the neighbourhood of the knee dorsally slightly darker, femora smooth, tibiae especially distally with some spinulose imbrications, second tarsal segments with spinulose imbrications; the tibia of the fore leg 308-340  $\mu$  long, 0.79-0.89 times as long as the width of the head across the eyes, length of hairs of the hind tibia 28-30  $\mu$  long; chaetotaxy of first tarsal segments 4, 4, 2-3, the lateral hairs of the fore tarsus (fig. 476) 2.2-2.9 times as long as the middle; length of hairs of the first tarsal segment of the hind leg 35-43  $\mu$ ; the second tarsal segment of the hind leg (fig. 477) with two dorsoapical hairs with expanded tips, 41-45  $\mu$  long, the tip two  $\mu$  wide; length of the empodial hair of the hind leg 25-31  $\mu$ . Length of the hind segments: femur fused with the trochanter 338-371  $\mu$ , tibia 385-401  $\mu$ , 1.08-1.15 times as long as the femur, and 0.96-1.10 times the width of the head across the eyes; first tarsal segment 29-35  $\mu$  long, second tarsal segment 93-102  $\mu$ .

Abdomen.— (fig. 478). Abdominal segments colourless, but in one specimen tergite VIII pale brown; tergite VI-VIII with spinulose imbrications; tergite III with 5-8 hairs, IV with 4-6; V, 3-4; VI, 2-4; VII two; VIII four; length of hair dorsally on segment IV, 20-25  $\mu$ , ventrally 16-25  $\mu$ , on tergite VIII, 23-31  $\mu$ . Siphunculi located on tergite V, colourless, flat, with 2-4 hairs, the pore yellowish, 33-40  $\mu$  wide. Cauda (fig. 479) broadly rounded, without a constriction but sometimes slightly bent inwards near the base, e.g. 130  $\mu$  wide and 54  $\mu$  long; at the base 116-151  $\mu$  wide, with 11-12 hairs, the longest 27-35  $\mu$  long. Subanal plate bilobed, with 15-17 hairs, 27-35  $\mu$  long. Subgenital plate with 2-3 anterior hairs, 18-23  $\mu$  long, and 12-14 posterior hairs, 27-37  $\mu$  long. Gonapophyses two, each with 5-7 hairs, the longest 10-14  $\mu$ . Spiracles on six abdominal segments, II-VII.

First stage larva of apterous viviparous female (figs. 480, 481; description of one or a few specimens). Body length 370  $\mu$ , but with folds, presumably 550-650  $\mu$ ; length of head plus pronotum 166  $\mu$ , 0.90 times the width of the prothorax; width of the head across the eyes 159  $\mu$ ; the head ventrally with a pair of hairs more sturdy than other hairs of the head, 30  $\mu$  (others 22-35  $\mu$ ) long and two  $\mu$  wide near the base, the process with a diameter of eight  $\mu$ ; anterior to these four hairs also slightly more sturdy hairs as dorsally; anterior to the eyes an anterior and a posterior row, each of four hairs, 24-30  $\mu$  long, 1.5  $\mu$  wide near the base, with a process of six  $\mu$  wide. Antennae with five segments, 174  $\mu$  long, segment II smooth with a hair 25  $\mu$  long, segment III, 29  $\mu$  long, with some spinulose imbrications; IV, 27  $\mu$  long with spinulose imbrications and two hairs 20  $\mu$  long; V, 74  $\mu$  long with a processus terminalis 20  $\mu$  long, with spinulose imbrications, one hair and five apical setae, 15  $\mu$  long. The prothorax on the posterolateral side with three wax glands, the mesothorax on each side with a row of three wax glands, with facets. The last rostral segments 118  $\mu$  (116-131  $\mu$ ) long, 1.66 (1.38-1.76) times as long as the second tarsal segment of the hind leg; the distal 40  $\mu$  of the segment with almost parallel sides, at 40  $\mu$  from the tip 10  $\mu$  wide. The femora smooth, the tibiae distally with a few spinulose imbrications, the second tarsal segments with spinulose imbrications; tibia of the fore leg 120  $\mu$  long, 0.75 times as long as the width of the head across the eyes; length of distal hairs of the hind tibia 33  $\mu$ . All first tarsal segments with two hairs, of the hind leg 50  $\mu$  long. Two dorsoapical hairs of the second tarsal segment of the hind leg with expanded tips, 50  $\mu$  long, the other apical hairs less sturdy. The abdominal segments smooth, without wax glands, segments I and II with four dorsal hairs, III-VIII with two, on VIII, 31  $\mu$  long. Cauda with two hairs, 17  $\mu$  long. Siphunculi lacking. The body almost without symbionts.

Embryos in nine alatae similar to first stage larvae of apterae with last rostral segment pointed and e.g. 325  $\mu$  long and marginal and dorsal hairs 22-35  $\mu$  long and near the base two  $\mu$  wide; one alata with embryos with the last rostral segment 194  $\mu$  long and rather blunt, and with marginal or dorsal hairs 5-10  $\mu$  long.

Host plant records.— Specimens were collected in Java: on *Scurrula* spec., leaf galls, Rembangan, 700 m, 27.viii.1950, 3.ix.1950, and 24.ix.1950 leg. F.W. Rappard, in the collection at the British Museum (Natural History), London.

The aphids live in galls, the leaves are folded upwards along the main vein, boat-shaped, closed, the upperside of the leaf inwards, with niches in which the aphids stay, the niches frequently covered with wax; leaves of *Scurrula* covered with branched hairs, which are less numerous in older leaves on the upper surface than

on the lower (Dr F.W. Rappard, unpublished).

Alatae were collected 2.ix.1950.

Etymology.— Plicator, the folder, pointing to the aphids who fold the leaves.

**Rappardiella scurrulae spec. nov.**

(figs. 482-493)

Types.— Holotype (aptera viviparous female) from *Loranthus* spec. Tjisoeroepan, 21.viii.1916, leg. P. van der Goot, no. 153-1-1; MS name P. v.d. Goot: *Ceratoglyphina nigra*. Paratypes: eight apterous viviparous females, and four alate viviparous females with the same data as the holotype. Holotype and paratypes on seven slides in the collection at the Laboratorium voor Entomologie, Wageningen.

Apterous viviparous female.— In life: Body velvety black or dull bluish black, sometimes abdomen brownish turning to black on thorax and head (F.W. Rappard, P. van der Goot, unpublished). In some collections, specimens which are orange yellow, and the head without violet (Rappard). Eyes black, legs and antennae grey. Siphunculi with a dark rim. Dorsum without wax, but margins with a continuous flat, narrow wax fringe.

Macerated specimens.— (figs. 482-485; described from 9-14 specimens): Body 1.71-2.00 mm long, 1.3-1.5 times as long as it is wide.

Head.— Head brown, with pustules with a diameter of 5-10  $\mu$ , almost flat, but on the frons 2-4  $\mu$  high, with dotted surface. Frons curved, protruding between the antennae in the middle e.g. 35  $\mu$ . Head across the eyes 465-504  $\mu$  wide. A pair of horns (figs. 483, 484) located ventrally, medial to the antennae, pointing backwards, 69-138  $\mu$  wide at the base, and 30-55  $\mu$  high (the process of the hair on it not included) with broadly rounded tip; on the tip one hair, 15-16  $\mu$  long, 5-6  $\mu$  wide at the base; its process 18-20  $\mu$  wide at its base, 12-15  $\mu$  high. Frons anterior and dorsal to the horns with 10-12 hairs, sometimes two ventral hairs on these as sturdy as the hairs on the horns; between the eyes an anterior and posterior row each of 4-5 hairs, 65-72  $\mu$  long. Wax glands are lacking on the head. Antennae with five segments, brown, the last segment darker, 437-562  $\mu$  long, 0.25-0.30 times as long as the body, 0.9-1.1 times the width of the head across the eyes, and 1.5-1.6 times as long as the tibia of the fore leg; segments I and II with some wrinkles, III-V with spinulose imbrications, the spinulae 2-4  $\mu$  long; segment III, 167-224  $\mu$  long, 2.5-2.6 times as long as IV, 1.5-1.8 times as long as V, with 6-9 hairs, 40-45  $\mu$  long; IV, 67-90  $\mu$  long, 0.6-0.7 times as long as V, usually with two hairs; V, 100-131  $\mu$  long, the processus terminalis 21-42  $\mu$  long, with one hair and five apical setae. Eyes (fig. 484) brown, the anterior and medial side at the same height as the dorsum, but the outer and posterior side an almost perpendicular wall, about 40  $\mu$  above the margin of the head, with three ommatidia, 14-16  $\mu$  diameter. Ultimate rostral segment 106-118  $\mu$  long, 0.95-1.07 times as long as the second tarsal segment of the hind leg; stylets 625-725  $\mu$  long.

Thorax.— Prothorax the same colour as the head, fused with the head, with a distinct groove running from posterior to the eyes in the posteromedial direction to a large muscular plate; pleurally a groove, passing from the posterior margin forward to the same muscular plate; a median groove, and two elongate-oval swellings between the pleural and median grooves, with pustules with dotted surface, the lateral

margins with a longitudinal row of 6-9 wax glands with facets and pustules; spinal wax glands are lacking; on each side two hairs, and dorsally 8-11 hairs.

Mesothorax brown, with a segmental border between the prothorax and the metathorax, with pustules at most two  $\mu$  high, marginal wax glands on each side in a longitudinal row of 6-9, with facets 2-4  $\mu$  wide; dorsally 22-33 hairs. Metathorax brown, with a segmental border between abdominal segment I, with pustules, and on each side 5-6 wax glands in a longitudinal row, and dorsally 17-28 hairs. Legs brown, the ventral side of the femora and the middle of the tibiae slightly paler, smooth, but the second tarsal segments with some imbrications, almost without spinulae. Tibia of the fore leg 283-342  $\mu$  long, 0.60-0.68 times as long as the width of the head across the eyes. First tarsal segments of fore- and midleg with four hairs, the lateral of the fore leg 2.2-2.7 times as long as the middle hairs; of the hind leg with two hairs, 53-61  $\mu$  long. Second tarsal segments of the hind leg 0.21-0.24 times as long as the tibia of the hind leg, and 0.22-0.25 times as long as the width of the head across the eyes, with two dorsoapical hairs expanded at the tips, 49-61  $\mu$  long, the tips 3-4  $\mu$  wide. Empodial hairs of the hind leg 33-37  $\mu$  long. Length of the segments of the hind leg: femur plus trochanter 358-409  $\mu$ , tibia 448-535  $\mu$ , 1.24-1.32 times as long as the femur, and 0.95-1.07 times the width of the head across the eyes, first tarsal segment 37-45  $\mu$ , second tarsal segment 106-118  $\mu$ .

Abdomen.— Abdomen brown like the head with small colourless patches, a distinct segmental border between abdominal segment I and the metathorax, margins of I and II fused, but dorsally a segmental border more or less observable, II-VI fused, more or less also with VII, VIII with a segmental border; the skin of I-VI with almost flat dotted pustules, but VII and VIII with spinulose imbrications; marginally on each side oval wax glands in a longitudinal row, with facets, 3-4  $\mu$  wide, numbering on segment I, 3-5; II, 2-5; III-VI, 4-5; VII, 3-7; VIII, 2-5; spinal wax glands are lacking. Tergite I with 16-24 hairs; II with 14-21; III, 13-21; IV, 13-18, the siphuncular hairs not included; V, 11-27; VI, 4-6; VII, 2-4, and VIII, 9-12; length of hairs on tergite IV, 55-71  $\mu$ ; ventrally on IV, 27-43  $\mu$ ; on tergite VIII, 60-88  $\mu$ . Siphunculi located dorsally on segment IV, same colour as the surroundings, flat with some concentrically arranged wrinkles, with 5-7 hairs, pore brown, the margin 40-80  $\mu$  from the margin of the abdomen, diameter of the pore 53-65  $\mu$ , with a rim 2-5  $\mu$  wide. Cauda (fig. 485) transversely elongate, without a constriction, e.g. 160  $\mu$  wide at the base and 58  $\mu$  long; at the base 160  $\mu$  wide, with 7-9 hairs, the longest 50-61  $\mu$ . Subanal plate bilobed, with 18-26 hairs, the longest 60-89  $\mu$ . Subgenital plate with two anterior hairs 35-52  $\mu$  long, and 5-8 along the posterior margin, 43-53  $\mu$  long. Gonapophyses two, each with 6-10 hairs, the longest 8-14  $\mu$ .

Alate viviparous female.— In life: Body, eyes, antennae etc. black. Pterostigma blackish (P. van der Goot, unpublished).

Macerated specimens.— (figs. 486-493; described from four fragmentary specimens). Body length 2.04 mm, 1.9 times as long as it is wide.

Head.— (fig. 486). Head brown, smooth, with dots, width across the eyes 500-520  $\mu$ ; anterior to the paired ocelli, and dorsal to the median ocellus 5-11 hairs, all of normal shape, but ventral to the median ocellus, medial to the base of the antennae a pair of short thick hairs (fig. 487), 10-14  $\mu$  long, and three  $\mu$  wide on a process with a diameter of 9-12  $\mu$ ; posterior to the paired ocelli four hairs; length of dorsal hairs 30-45  $\mu$ .

Antennae brown, with black rings, with five segments 1.00-1.14 mm long, 0.53 times as long as the body, and 1.9-2.2 times the width of the head across the eyes; segment I somewhat wrinkled, segment II wrinkles arranged in an irregular network, almost without spinulae; segments III-V (fig. 488) with ring-shaped secondary rhinaria, the rings are not closed on the dorsal side, with a space of 4-30  $\mu$ ; between the rhinaria are 3-4 concentric spinulose imbrications, dorsally and ventrally with interconnections; the rhinaria are 3-4  $\mu$  wide. The primary rhinarium of segment IV moulded with a secondary rhinarium to a complex structure, but that of segment V well distinguished from annular rhinaria, pale brown, located distally, 2-10  $\mu$  wide, annular, with some circular accessory rhinaria close by; segment III with 41-49 annular rhinaria, IV with 8-14, V with 9-12; hairs of segment III, 14-18  $\mu$  long. Length of segment III, 550-620  $\mu$ , 3.1-3.7 times as long as IV, 2.9-3.8 times as long as V; segment IV, 150-200  $\mu$  long, 0.9-1.0 times as long as V; V, 159-190  $\mu$  long, the processus terminalis 25-31  $\mu$ . The last rostral segment (fig. 489) 113-118  $\mu$  long, 0.96-1.03 times as long as the second tarsal segment of the hind leg, without accessory hairs; length of stylets 460-510  $\mu$ . Eyes compound, the ocular tubercle extending sideways about 25  $\mu$ .

Thorax.— Sides of the prothorax pale brown, the mesothorax brown. Fore wing (fig. 490) medial vein once branched, the hind wing with two oblique veins. Legs brown, the femora dorsally slightly darker, the tibiae distally with a few spinulae, second tarsal segments with spinulose imbrications; the tibia of the fore leg 535-570  $\mu$  long, 1.03 times as long as the width of the head across the eyes, length of hairs of the hind tibia 40-41  $\mu$ ; chaetotaxy of first tarsal segments 4, 4, 2, the lateral hairs of the fore tarsus 2.8 times as long as the middle; length of hairs of the first tarsal segment of the hind leg 47-50  $\mu$ ; the second tarsal segment of the hind leg (fig. 491) with two dorsoapical hairs with expanded tips, 51-56  $\mu$  long, the tip four  $\mu$  wide; length of the empodial hair of the hind leg 31-34  $\mu$ . Length of the hind segments: femur fused with trochanter 488-504  $\mu$ , tibia 716-740  $\mu$ , 1.45-1.47 times as long as the femur, and 1.41-1.48 times the width of the head across the eyes; first tarsal segment 41  $\mu$  long, second tarsal segment 114-118  $\mu$ .

Abdomen.— (fig. 492). Abdominal segments I-V colourless, VI and VII colourless with dorsally a pair of pale brown patches with some spinulose imbrications, VIII with a pale brown plate, with a curved anterior margin, and emarginate at the posterior margin, with spinulose imbrications; tergite III with eight hairs; IV nine, the siphuncular hairs not included; V, 9-10; VI, 3-4; VII, 2-3; VIII, 9-12; hairs dorsally on segment IV, 37-43  $\mu$  long, ventrally 37  $\mu$ , on tergite VIII, 61-71  $\mu$ . Siphunculi located on tergite IV, pale brown, a cone about 15  $\mu$  high with a diameter of 140  $\mu$ , with some concentrically arranged wrinkles and a few spinulose imbrications, with 6-10 hairs, the pore yellowish, 55-57  $\mu$  wide. Cauda (fig. 493) transversely elongate, e.g. 150  $\mu$  wide, the knob 74  $\mu$  wide, 35  $\mu$  long, and almost without a constriction; the knob 63-74  $\mu$  wide, with 8-10 hairs, the longest 55-69  $\mu$ . Subanal plate bilobed, with 21-26 hairs, the longest 57-71  $\mu$ . Subgenital plate with two anterior hairs, 35-40  $\mu$  long, and 5-9 posterior hairs, the longest 35-55  $\mu$ . Gonapophyses two, each with 8-10 hairs, the longest 12-18  $\mu$ . Spiracles on six abdominal segments, II-VII.

Host plant records.— Specimens were collected in Java by P. van der Goot (1) in the collection at the Laboratorium voor Entomologie, Wageningen, and by F.W. Rappard (2) in the collection at the British Museum (Natural History), London: *Loranthus* spec. Tjisoeroepan (Mt. Papandajan, 1220 m), 21.viii.1916 (1); *Scurrula*, Rayap

(550 m), 28.v.1950 (2); *Scurrula*, Rembangan, Djember, 17.vii.1950, 27.viii.1950, 17.ix.1950 (2). P. van der Goot (manuscript) mentions as host plant of this aphid *Loranthus* and *L. pentandra*. *Loranthus* could possibly have been *Scurrula* because, in my opinion, a misidentification of Loranthaceae cannot be excluded.

The aphids live on young twigs (P. van der Goot, manuscript), and are good walkers (F.W. Rappard, manuscript).

Etymology.— *Scurrulae*, of *Scurrula* L., a genus of the Loranthaceae.

### Genus *Reticulaphis* Takahashi, 1958 (figs. 494 - 524)

*Reticulaphis* Takahashi, 1958: 11 (type species *Reticulaphis shiiae* Takahashi, 1958).  
*Schizoneuraphis* Van der Goot, 1917: 245, partly.

Description.— I. Morphs from secondary hosts (*Castanopsis* Spach., *Ficus* L.).

Apterous viviparous female.— (one species). In life: Black with a fine or distinct fringe of wax.

Macerated specimens.— Body ovate or elliptical, flattened, strongly sclerotized, 0.4-0.9 mm long, 1.2-1.8 times as long as it is wide, with three parts separated from each other by membranes: (1) head plus thorax and abdominal tergite I (prosoma); the posterior margin of tergite I is separated from the anterior and lateral margins of complex II-VII. (2) the complex of tergites II-VII, and (3) the dorsally free tergite VIII; (1) is 6-10 times as long as (2) and 8-13 times as long as (3). The middle of the prosoma with three transverse ridges or with muscular plates, a pair of which on each of the thoracic segments and on tergite I are most striking; the whole dorsum reticulated. The margin of the body with 10 pairs of hairs, three pairs of which anterior to the eyes; the hairs long, pointed 60-130  $\mu$  long, but in subspecies of *R. distylii* hairs much shorter, e.g. 25  $\mu$  long, with widened, serrate apices and often markedly curved backwards. The middle of the dorsum with five pairs of short hairs. The complex of tergites II-VII on each side with six minute hairs, the middle without hairs; tergite VIII with two hairs, long, but in the subspecies of *R. distylii* short. Antennae not observable from above, 40-70  $\mu$  long, with three segments or without segmentation. Eyes with three ommatidia, one of them sometimes reduced. Legs very short, tarsi not segmented, claws frequently lacking.

Alate viviparous female.— (of *R. distylii*). Length of the body 1.7 mm. Antennal segment III, 2.6-4.2 times as long as IV, 4.3-5.6 as V. Length of dorsal hairs 74-167  $\mu$ .

First stage larvae of apterous viviparous females dorsally with sclerotic head plus prothorax, mesothorax, metathorax, and abdominal segments I-VIII; without wax glands.

Larvae of alatae with button organs; embryos also sometimes inside the alatae with button organs.

II. Morphs from *Distylium stellare*, from *R. distylii* only, inside galls on the leaves. Apterous viviparous females length of hairs dorsally on the head 63-82  $\mu$ . Second tarsal segments dorsoapically with stout hairs, 35-40  $\mu$  long, and widened at the tips, 3-5  $\mu$  wide. Wax glands linear or indistinct. The fundatrix without siphunculi, the next generations siphunculi present. Alate viviparous females: antennal segment III,

1.9-2.6 times as long as IV, and 2.4-2.7 times as long as V; length of hairs on tergite IV, 16-25  $\mu$ ; on tergite VIII, 30-43  $\mu$ ; on the anal plate 27-37  $\mu$ . The second tarsal segment of the hind leg with three hairs. Embryos inside the body of these alatae are indistinguishable from first instar larvae of *R. distylii* subspec. *rotifera* from leaves of *Ficus*.

Etymology.— *Reticulaphis*, reticulated aphid, name given by Takahashi (1958) because of the presence of dorsal reticulations in the apterae from secondary hosts.

***Reticulaphis distylii* (Van der Goot, 1917)**  
(figs. 494-524)

*Schizoneuraphis distylii* Van der Goot, 1917: 247.

*Astegopteryx fici* Takahashi, 1923: 55, 146; Eastop & Hille Ris Lambers, 1976: 373 (synonymy).

*Astegopteryx javensis* Takahashi, 1921: 94; Eastop & Hille Ris Lambers, 1976: 96, 373 (synonymy).

*Thoracaphis fici*; Takahashi, 1931: 92.

*Reticulaphis distylii*; Hille Ris Lambers & Takahashi, 1959: 9.

Types.— Lectotype (alate viviparous female, here designated) from galls of *Distylium racemosum* (Van der Goot, 1917: *D. stellare*), Kadjar, Dieng, 20.viii.1915, leg. P. van der Goot. Paralectotypes: five alate viviparous females with the same data as the lectotype. Lectotype and paralectotypes on one slide in the collection at the British Museum (Natural History), London.

Introduction.— Van der Goot (1917) describes apterae, alatae and the galls of *Distylium stellare* O.K. from which he collected these aphids. The alatae were collected 20.viii.1915, and the preserved alatae and nymphs one was made lectotype by Hille Ris Lambers & Takahashi (1959); these authors, however, do not accept the description of Van der Goot of the fundatrix from the galls, and his description of the galls, which presumably were made on the basis of material Van der Goot collected at the beginning of April 1915. The views of Hille Ris Lambers & Takahashi are held in the present publication.

I. Morphs from galls of *Distylium stellare*

1. Fundatrix

Macerated specimens.— (figs. 494-496; described from two specimens, leg. Harjono, 29.viii.1957, gall no. 4). Body length 890-960  $\mu$ , 1.3-1.4 times as long as it is wide, much inflated.

Head.— Head anterior part pale brown, the sides colourless, distance between the outer margins of the eyes 270-271  $\mu$ , anteriorly in the middle six hairs, and between the eyes six hairs, near to the base two  $\mu$  wide but the ends thread-like, 65-82  $\mu$  long. Antennae pale brown, with three segments, 131-139  $\mu$  long, 0.14-0.16 times as long as the body, 0.48-0.51 times the distance between the outer margins of the eyes; segments I and II almost smooth, length of hair on II, 50  $\mu$ ; segment III with imbrications, in the distal part with some spinulae, without hairs but with three apical setae, the longest 19-20  $\mu$ ; the processus terminalis four  $\mu$  long, the penultimate rhinarium 20-23  $\mu$  from the tip. Eyes brown, with three ommatidia with a diameter of 10-11  $\mu$ . Ultimate rostral segment (fig. 495) 55-58  $\mu$  long, 1.22-1.35 times as long as the second tarsal segment of the hind leg; stylets 171-185  $\mu$  long.

Thorax.— The prothorax colourless, fused with the head, on each side two marginal hairs and seven dorsal hairs, 92  $\mu$  and 102  $\mu$  long respectively. Meso- and



metathorax colourless, each with two marginal hairs, the mesonotum with six dorsal hairs, the metanotum with three. Legs evenly pale brown, the femora, tibiae and second tarsal segments with some spinulose imbrications, the spinulae not more than one  $\mu$  long. Tibia of the fore leg 108-116  $\mu$  long, 0.40-0.43 times as long as the distance between the outer margins of the eyes. First tarsal segments (fig. 496) fused with the second tarsal segments, and without hairs. Second tarsal segments (fig. 496) with two dorsoapical hairs 30-35  $\mu$  long, with expanded tips, four  $\mu$  wide; the two lateral hairs smaller but also with expanded tips. Empodial hairs are lacking. Length of the segments of the hind leg: femur plus trochanter 163  $\mu$ , tibia 170  $\mu$ , 1.04 times as long as the femur, and 0.63 times as long as the distance between the outer margins of the eyes, first tarsal segment fused with the second tarsal segment 39-45  $\mu$ .

Abdomen.— Abdomen colourless without distinct segmental borders, segments VII and VIII dorsally with indistinct spinulose imbrications. Marginally and dorsally no structures of wax glands observable. Segments I-VII each with one marginal hair, 65-95  $\mu$  long, dorsally segment I with one hair, 94  $\mu$  long, dorsal hairs on segments II-VII lacking, ventral hairs 45-50  $\mu$  long. Tergite VIII with 3-4 hairs, 90  $\mu$  long. Siphunculi lacking. Cauda without an incision, posteriorly rounded, at the base 75  $\mu$  wide and 30  $\mu$  long, with four hairs, the longest 52  $\mu$ . Subanal plate at the posterior margin, with nine hairs, 76  $\mu$  long. Subgenital plate with conspicuous spinulose imbrications, with two anterior hairs, 37  $\mu$  long and 11 posterior hairs, 33  $\mu$  long. Gonapophyses two, each with 3-4 hairs, 15  $\mu$  long. Spiracles on the abdomen not observable.

2. Apterous viviparous female of next generations. In life: Whitish.

Macerated specimens.— (figs. 497-499; described from 1-3 specimens, leg. Harjono, 29.viii.1957, gall no. 4). Body length 735-980  $\mu$ , 1.5 times as long as it is wide.

Head.— Anterior part of the head very pale brown, the sides colourless, distance between the outer margins of the eyes 239-280  $\mu$ , dorsally smooth, anteriorly in the middle six hairs, and between the eyes six hairs, near to the base two  $\mu$  wide but the ends thread-like, 63-80  $\mu$  long. Antennae pale brown, with five segments, 176-199  $\mu$  long, 0.20-0.24 times as long as the body, 0.70-0.83 times the distance between the outer margins of the eyes; segments I and II almost smooth, length of hair on II, 35  $\mu$ ; segment III almost smooth, 43-51  $\mu$  long, 1.1-1.2 times as long as IV, and 0.86-0.93 times as long as V; segment IV with imbrications with some spinulae, 35-45  $\mu$  long, 0.70-0.82 times as long as segment V; segment V with imbrications with some spinulae, 50-55  $\mu$  long, with one hair, 16  $\mu$  long and with four apical setae, 22  $\mu$  long; the processus terminalis 23  $\mu$  long, the penultimate rhinarium on segment IV, 64  $\mu$  from the tip. Eyes brown, with three ommatidia with a diameter of 11-12  $\mu$ . Ultimate rostral segment 61  $\mu$  long, 0.91-0.94 times as long as the second tarsal segment of the hind leg; stylets 176-204  $\mu$  long.

Thorax.— The prothorax colourless, fused with the head, with on each side two marginal hairs, 71  $\mu$  long, and dorsally seven hairs the longest 57  $\mu$ . The mesothorax with on each side two marginal hairs and nine dorsal hairs, the metathorax with two and eight hairs respectively. Legs evenly pale brown, femora, tibiae and second tarsal segments with a few imbrications with some spinulae. Tibia of the fore leg 121-144  $\mu$  long, 0.51-0.59 times as long as the distance between the outer margins of the eyes. First tarsal segments not fused with the second tarsal segments, all with three hairs, the lateral of the fore legs 2.2 times as long as the middle hair. Second tarsal

segments with two dorsoapical hairs, of the hind leg 40-45  $\mu$  long, with expanded tips. Empodial hair of the hind leg 22-23  $\mu$  long. Length of the segments of the hind leg: femur plus trochanter 179  $\mu$ , tibia 208  $\mu$ , 1.16 times as long as the femur, and 0.64 times the distance between the outer margins of the eyes, first tarsal segment 25  $\mu$  long, second tarsal segment 60-67  $\mu$ .

Abdomen.— Abdominal segments I-VI colourless, VI with some very pale brown areas with some spinulose imbrications, VII in the middle pale brown with spinulose imbrications, tergite VIII pale brown with spinulose imbrications; segments I-VII each with one marginal hair, 50-83  $\mu$  long, tergites I-III with 7-8 hairs, IV-VI with 1-4, and VII without a hair; dorsal and ventral hairs on IV, 37  $\mu$  long; tergite VIII with eight hairs, the middle 80  $\mu$  long. Abdominal segments II-V (figs. 498, 499) marginally with lines 4-12  $\mu$  long and less than 0.5  $\mu$  wide, running parallel or arranged somewhat as a netting, observable only at a magnification of 500. Siphunculi on segment VI, pale brown, a cone at the base about 40  $\mu$  wide and 15  $\mu$  high, with some concentric wrinkles and spinulose imbrications, the pore brownish, with a diameter of 20-25  $\mu$ . Cauda without an incision, 84  $\mu$  wide, with eight hairs, the longest 57  $\mu$ . Subanal plate bilobed, with 12 hairs, 59  $\mu$  long. Subgenital plate with conspicuous spinulose imbrications, with 6-8 anterior hairs, 51  $\mu$  long, and 10-13 posterior hairs, 47  $\mu$  long. Gonapophyses two, each with 3-4 hairs, 16  $\mu$  long. On the abdomen five spiracles on each side of segments II-VI.

3. Alate viviparous female, fundatrigenia.— In life: Head and thorax black. Abdomen dark green. Antennae, eyes and legs black. Pterostigma of the fore wing greyish black (Van der Goot, 1917).

Macerated specimens.— (figs. 500-506; described from 11 specimens, leg. Harjono, x.1957, from conical gall no. 4). Length of the body 1.47-1.87 mm, 2.0-2.1 times as long as it is wide.

Head.— (fig. 500). Head black, with blunt spinulae of about one  $\mu$  diameter, somewhat arranged as a network; width across the eyes 365-405  $\mu$ , dorsal to the median ocellus two pairs of hairs, between the paired ocelli two hairs, and posterior to the paired ocelli 5-7 hairs, 18-23  $\mu$  long. Ventrally posterior to the median ocellus 5-8 hairs. Antennae brown, with black rings, with five segments 483-580  $\mu$  long, 0.30-0.36 times as long as the body, and 1.2-1.5 times as long as the width of the head across the eyes; segment I somewhat wrinkled and with spinulose imbrications; segment II with wrinkles and spinulose imbrications, length of hair 18-20  $\mu$ ; segments III-V (fig. 501) with ring-shaped secondary rhinaria, the rings are not closed on the dorsal side, with a space of 4-20  $\mu$ ; between the rhinaria are three concentric imbrications, dorsally and ventrally with interconnections, and only a few rather coarse spinulae; the rhinaria are 2-3  $\mu$  wide. The primary rhinaria are moulded with 2-4 secondary rhinaria to a complex structure; segment III with 19-31 annular rhinaria, IV with 8-12, V with 6-10; hairs are lacking on segments III-V, but on segment V are 3-4 apical setae, 16-18  $\mu$  long. Length of segment III, 220-271  $\mu$ , 1.9-2.6 times as long as IV, 2.4-2.7 times as long as V, and 1.1-1.3 times as IV plus V; segment IV, 98-130  $\mu$  long, 1.0-1.3 times as long as V; segment V, 86-105  $\mu$  long, the processus terminalis 12-18  $\mu$ . The last rostral segment 65-73  $\mu$  long, 0.75-0.87 times as long as the second tarsal segment of the hind leg, without accessory hairs; length of the stylets 220-231  $\mu$ . Eyes black, the ocular tubercle extending sideways about 25  $\mu$ .

Thorax.— Sides of the prothorax blackish, mesothorax black. Fore wing (fig. 502)

radial sector, distal part running straight to the tip of the wing, medial vein once branched, the anal vein straight; the cubitus separated from the anal vein, starting 10-30  $\mu$  distal to the anal vein; the hind wing with two oblique veins. Legs brown, the basal part of the femora paler, the knees and the distal part of the tibiae slightly darker; femora, second tarsal segments, and especially the tibiae with spinulose imbrications, the spinulae 1-3  $\mu$  long; the tibia of the fore leg 335-358  $\mu$  long, 0.84-0.87 times as long as the width of the head across the eyes, length of the hairs of the hind tibia 29-33  $\mu$ ; the middle part of the first tarsal segments (fig. 503) protrudes 14-18  $\mu$  beyond the basal part, number of hairs of all first tarsal segments three, the lateral hairs of the fore tarsus 2.4-3.6 times as long as the middle hairs, length of hairs of the hind tarsus 51-57  $\mu$ ; the four apical hairs of the second tarsal segment (fig. 504) of the hind leg with expanded tips, the dorsal hairs 51-59  $\mu$  long, the tip 5-6  $\mu$  wide; empodial hair of the hind leg 23-27  $\mu$  long, with an expanded tip. Length of the hind segments: femur fused with trochanter 334-369  $\mu$ , tibia 433-472, 1.23-1.36 times as long as the femur, and 1.15-1.25 times the width of the head across the eyes; first tarsal segment 41-43  $\mu$  long, second tarsal segment 83-91  $\mu$ .

Abdomen.— (fig. 505). Abdominal segments I-VII colourless, segment VII with spinulose imbrications, marginally on each segment one hair, 25-40  $\mu$  long, dorsally segments I-III with 6-8 hairs, IV with 3-8, 16-25  $\mu$  long, and the ventral hairs 22-25  $\mu$ ; tergite V with 2-3 hairs; VI, 1-3, and hairs are lacking on tergite VII. Tergite VIII with a transverse elongate brown or pale brown band, with spinulose imbrications and 8-10 hairs, 30-43  $\mu$  long. Siphunculi situated on segment VI, colourless or pale brown with a diameter of about 40  $\mu$ , the pore brown, 23-33  $\mu$  wide. Cauda (fig. 506) at the base 96-131  $\mu$  wide, and about 40  $\mu$  long, ventrally with a six  $\mu$  protruding middle part, with 8-10 hairs, 27-35  $\mu$  long. Subanal plate bilobed, with 15-16 hairs, 27-37  $\mu$  long. Subgenital plate with 12-14 anterior hairs, 25-30  $\mu$  long, and 11-14 posterior hairs, 25-31  $\mu$  long. Gonapophyses two, each with 4-9 hairs, 12-16  $\mu$  long. The abdomen with on each side four spiracles, on segments II-V.

4. First stage larva of apterous viviparous female (fig. 507) from galls of *Distylium stellare* (described from four specimens, leg. D. Noordam, 31.xii.1976, from gall). Body colourless, 250-330  $\mu$  long. Length of hairs on the head 60  $\mu$ . Antennae colourless, with four segments, 134-138  $\mu$  long; segment II smooth, with a hair, 40  $\mu$  long; segment III with some smooth imbrications, 43-48  $\mu$  long, 0.84-1.00 times as long as segment IV, without hairs; IV, 51-57  $\mu$  long, with smooth imbrications, without hairs, but with four apical setae, 32-35  $\mu$ , the processus terminalis 18-20  $\mu$  long. Length of the last rostral segment 62-65  $\mu$ , of the stylets 137-141  $\mu$ . The legs colourless, smooth, but the second tarsal segments with a few imbrications; tibia of the fore leg 83-91  $\mu$  long; length of distal hairs of the hind tibia 29-38  $\mu$ . All first tarsal segments with two hairs, of the hind leg 31-35  $\mu$  long. Two dorsoapical hairs of the second tarsal segment of the hind leg 51-53  $\mu$  long, with expanded tips, 1-2  $\mu$  wide. Dorsal thoracic hairs 45  $\mu$  long, on tergite VIII, 40-48  $\mu$ . Cauda with two hairs, 20  $\mu$  long. Siphunculi are lacking.

In some larvae collected by Harjono 29.viii.1957 the length of the body is 370  $\mu$ , length of hairs on the head 70-72  $\mu$ , apical setae on antennal segment IV, 45-50  $\mu$ , marginal hairs 67-71  $\mu$ .

The body of each alata contains about 50 embryos. Hille Ris Lambers and Takahashi (1959) state that these embryos are indistinguishable from first instar larvae of

*R. distylii* subsp. *rotifera* from *Ficus? pruniformis* Bl., which they described. Some characteristics of these embryos are mentioned below.

5. Embryo inside alata from *D. stellare* (figs. 508, 509; description of three specimens, leg. Harjono X-1957, conical gall no. 4): Body length 280-295  $\mu$ . The head anterior to the eyes with a ventral pair of hairs with acute tips, and a dorsal pair with expanded tips, between the eyes four hairs with expanded tips, the marginal 29-32  $\mu$  long, the two dorsal hairs 12-13  $\mu$ . Antennae with four segments, 72-74  $\mu$  long; segment III, 25  $\mu$  long, without hairs; segment IV, 25  $\mu$  long with four apical setae, the longest 43-50  $\mu$ . The prothorax on each side with two marginal hairs, the longest 27-31  $\mu$ , and two dorsal hairs 10-12  $\mu$  long. Meso- and metathorax on each side each with two marginal hairs, the longest 22-23  $\mu$ , and each with one pair of dorsal hairs, 9-10  $\mu$  long; all dorsal hairs of head, thorax and abdomen (fig. 509) with expanded tips. Abdominal segment I with on each side one marginal hair, 18-20  $\mu$  long, and one pair of dorsal hairs, 8  $\mu$  long. Abdominal segments II-VII without dorsal hairs, each with a marginal hair, on II, 15-18  $\mu$  long; III, 12-15  $\mu$ ; IV, 12-15  $\mu$ ; V, 12-16  $\mu$ ; VI, 16-20  $\mu$ ; VII, 20-22  $\mu$ . Tergite VIII with two hairs, 29  $\mu$  long. Siphunculi are lacking. Cauda with two hairs, acute, about 10  $\mu$  long.

## II. Morphs from *Ficus* L.

1. Apterous viviparous female.— Exul. In life: Black, dull, with a fine or sometimes distinct broad fringe of wax (note of F.W. Rappard). Very young larvae pale brownish; for larvae see further on.

Macerated specimens.— (figs. 510-512; described from seven specimens, leg. P. v.d. Goot, 18.iv.1916; F.W. Rappard, 28.v.1951). Body black and not transparent or brown, transparent, oval 665-865  $\mu$  long, 1.2-1.4 times as long as it is wide, with three parts separated from each other by furrows or membranes: (1) head plus thorax and abdominal tergite I (prosoma); the posterior margin of tergite I is separated from the anterior and lateral margin of the complex II-VII by a membrane, and encircles and encloses on the posterior side abdominal tergite VIII, the cauda, subanal plate and subgenital plate (2) the complex of tergites II-VII, and (3) the dorsally free tergite VIII; (1) is 7.3-10.0 times as long as (2), and 11.9-12.8 times as long as (3); The margins of the prosoma are separated from the dorsum by a membrane, usually observable ventral to the dorsum; the sides black, perpendicular, about 175  $\mu$  high (the body flattish in appearance, Van der Goot unpublished), the legs and antennae not protruding outside the dorsum; the ventral side pale brown, flat, oval almost as the dorsum.

Prosoma.— The prosoma is a flat plate, lacking even all transverse furrows (as in *Metanipponaphis*, but in contrast to the other Nipponaphidini of Java); the marginal 20  $\mu$  of the plate bends 20-40  $\mu$  to the ventral side and the crenate margin is connected there to the more or less perpendicular sides by a colourless membrane. The surface is completely covered with almost flat pustules, in the middle three  $\mu$  higher than at the border, with a diameter of 12-18  $\mu$ . The pustules are squeezed flat against each other forming 3-6 angles; the whole has a reticular appearance. Muscular plates are reticulated like other parts of the dorsum, one pair on each of pro-, meso-, metathorax and abdominal tergite I are most striking, with a diameter of 70-90  $\mu$  and 15  $\mu$  deep in the centre. The frontal margin anterior to the eyes with six acute hairs, 69-90  $\mu$  long; between the eyes two hairs, 14-22  $\mu$  long. Eyes with three ommatidia, one of these located more lateral and ventral, 5-10  $\mu$  from the margin of the dorsum;

distance between the outer margins of the eyes 248-295  $\mu$ . The antennae (fig. 511) brown, inserted about 50  $\mu$  ventral to the dorsum, usually not observable from above, with three segments but fused and segments not distinct, bent sideways at segment I, 41-67  $\mu$  long, 0.07-0.09 times as long as the body, and 0.17-0.24 times the distance between the outer margins of the eyes; without hairs but with one apical seta, 14-18  $\mu$  long, the distal rhinarium located 8-14  $\mu$  from the tip, the penultimate rhinarium 14-22  $\mu$ . The ultimate rostral segment and the stylet not well observable. Pro-, meso- and metathorax on each side each with two acute hairs, 72-133  $\mu$  long, and dorsally each with a pair of hairs, 15-30  $\mu$  long.

Abdominal segments II-VII, a plate e.g. 208  $\mu$  wide and 80  $\mu$  long, with four angles, the posterior protruding backwards 10-20  $\mu$ , and the anterior and posterior margins parallel to each other. Each of the lateral sides, about 10  $\mu$  medial to the margin, with six processes with an indistinct hair, 3-8  $\mu$  long; other hairs are lacking on the plate. Siphunculi are lacking. Abdominal segment VIII e.g. 123  $\mu$  wide and 53  $\mu$  long, with a straight anterior margin, and a broadly rounded somewhat crenate posterior margin. The anterior part somewhat reticulated as the prosoma, in the middle a transverse raised ridge with on each side a bent hair; 61-110  $\mu$  long. The black perpendicular sides are, with their crenate dorsal margin, connected by a colourless membrane to the prosoma. The sides in the dorsal part are provided with angular pustules similar to those on the prosoma, more ventral with perpendicular stripes; hairs are lacking. The fore- and midlegs are black, usually observed horizontally and included in furrows in the flat pale brown ventral plate; the hind legs (fig. 512) are inserted more dorsally in the black sides and frequently protrude somewhat backwards. Length of the fore tibia 42-45  $\mu$ , 0.15-0.17 times as long as the distance between the outer margins of the eyes. First tarsal segments (fig. 512) are fused with the second tarsal segments and telescoped into the tibiae, hairs usually not observable; second tarsal segment of the hind leg 23-25  $\mu$  long, 0.28-0.36 times as long as the tibia of the hind leg, and 0.08-0.10 times as long as the distance between the outer margins of the eyes, with almost colourless claws, two dorsoapical hairs, 20-25  $\mu$  long. Length of the hind segments: femur fused with trochanter 62-80  $\mu$ , tibia 69-82  $\mu$ , 1.02-1.11 times as long as the femur, and 0.27-0.29 times the distance between the outer margins of the eyes, second tarsal segment 23-25  $\mu$ . Spiracles about 80  $\mu$  ventral to the margin of the dorsum, one pair between fore- and midlegs, the other between mid- and hind leg. Cauda, subanal plate and subgenital plate hidden; cauda e.g. 45  $\mu$  wide at the base, with a knob 35  $\mu$  wide and 22  $\mu$  long, the constriction with a diameter of 20  $\mu$ , with six hairs, 20-23  $\mu$  long. Subanal plate bilobed, with about 10 hairs, 35-41  $\mu$  long. Subgenital plate anterior hairs not observable, posterior hairs 9-10 along the posterior margin, 23-33  $\mu$  long. Gonapophyses not observable.

2. Alate viviparous female.— (leg. F.W. Rappard no. 188 *Ficus? pruniformis*, Mandiku, 12.v.1950). In life: Dark violet, blackish.

Macerated specimens.— (figs. 513-519; described from two specimens). Length of the body 1.67-1.68 mm, 1.8-2.0 times as long as it is wide.

Head.— (fig. 513). Head brown with blunt spinulae of about one  $\mu$  diameter; width across the eyes 373-393  $\mu$ , dorsal to the median ocellus two pairs of hairs, between the paired ocelli two hairs, and posterior to the paired ocelli 5-6 hairs, 84-167  $\mu$  long; acute and sometimes just before the end with a drop-like widening or bifurcated; ventrally posterior to the median ocellus, close to the base of the anten-

nae, on each side three hairs, about 25  $\mu$  long. Antennae brown, with black rings, with five segments, 539-551  $\mu$  long, 0.32-0.33 times as long as the body, and 1.4-1.5 times the width of the head across the eyes; segment I somewhat wrinkled and with spinulose imbrications; segment II with wrinkles and spinulose imbrications, length of hair 16-18  $\mu$ ; segments III-V (fig. 514) with ring-shaped secondary rhinaria, the rings are not closed on the dorsal side, with a space of 2-40  $\mu$ ; between the rhinaria are 3-5 concentric imbrications, dorsally and ventrally with interconnections and only a few rather coarse spinulae; the rhinaria are 2-3  $\mu$  wide. The primary rhinaria are moulded with 1-2 secondary rhinaria to a complex structure; segment III with 19-23 annular rhinaria, IV with 4-8, V with 4-5; hairs are lacking on segments III-V, but on V there are two or usually three apical setae, 22-23  $\mu$  long. Length of segment III, 318-330  $\mu$ , 3.3-4.2 times as long as IV, 4.9-5.6 times as long as V, and 2.0-2.2 times as long as IV plus V; segment IV, 76-96  $\mu$  long, 1.2-1.5 times as long as V; segment V, 59-65  $\mu$  long, the processus terminalis 5-10  $\mu$ . The last rostral segment 62-67  $\mu$  long, 0.85-0.90 times as long as the second tarsal segment of the hind leg, without accessory hairs; length of the stylets 230-267  $\mu$ . Eyes black, the ocular tubercle extending sideways about 25  $\mu$ .

Thorax.— Sides of the prothorax brown, mesothorax black. Fore wing (fig. 515) radial sector, distal part running straight to the tip of the wing, medial vein once branched, the anal vein almost straight; the cubitus separated from the anal vein, starting 40-50  $\mu$  distal to the anal vein; the hind wing with two oblique veins. Legs pale brown, the knees slightly darker; femora, tibiae and second tarsal segments with spinulose imbrications, the spinulae 1-4  $\mu$  long; the tibia of the fore leg 267-271  $\mu$  long, 0.68-0.73 times as long as the width of the head across the eyes, length of hairs of the hind tibia 51-53  $\mu$ ; the middle part of the first tarsal segments protrudes 10-12  $\mu$  beyond the basal part; number of hairs of first tarsal segments of the fore leg (fig. 516) three, the lateral hairs 2.3-2.4 times as long as the middle; number of hairs of the midleg three, of the hind leg two, but of one leg three, of the hind leg 49-51  $\mu$  long; the four apical hairs of the second tarsal segment of the hind leg (fig. 517) with expanded tips, the dorsal hairs 49-52  $\mu$  long, the tips 6  $\mu$  wide; empodial hair of the hind leg 22-23  $\mu$  long, with an expanded tip. Length of the hind segments: femur fused with trochanter 303-310  $\mu$ , tibia 399-411  $\mu$ , 1.32-1.33 times as long as the femur, and 1.05-1.07 times the width of the head across the eyes; first tarsal segment 37  $\mu$  long, second tarsal segment 73-74  $\mu$ .

Abdomen.— (fig. 518). Abdominal segments I-III colourless, marginally each with a hair, acute and before the end drop-shaped widened, 82-108  $\mu$  long; dorsally segment I with 5-6 hairs, II with 0-2, and hairs on III lacking. Segment IV with a marginal sclerite, pale brown, about 35  $\mu$  in diameter, with radially some ridges and one hair; dorsally colourless, with 1-4 hairs, 74-88  $\mu$  long. Segments V and VI marginally with one common sclerite, pale brown, 70-75  $\mu$  wide, with two hairs, each surrounded by some radially arranged ridges, dorsally V and VI colourless, with 1-3 and 0-1 hairs respectively. Segment VII marginally with a pale brown sclerite, 50-55  $\mu$  wide, with one hair, and surrounded by radially arranged ridges and spinulose imbrications; dorsally colourless, without hairs. Hairs on abdominal segments I-VII frequently droplet-shaped widened anterior to the tip and 76-108  $\mu$  long, but some dorsal hairs shorter. Tergite VIII with a transversely elongate pale brown band, with spinulose imbrications and around each of the 6-7 hairs radially arranged ridges;

length of the hairs 90-102  $\mu$ . Siphunculi colourless, hardly observable, at the base 37-43  $\mu$  wide, the pore 31-32  $\mu$ . Cauda (fig. 519) e.g. 133  $\mu$  wide at the base, the knob 65  $\mu$  wide and 28  $\mu$  long, with a constriction 43  $\mu$  wide, with 10-11 hairs, the longest 65-69  $\mu$ . Subanal plate (fig. 519) bilobed, with 17-18 hairs, the longest 53-63  $\mu$ . Subgenital plate with 10-11 anterior hairs, 36-37  $\mu$  long, and 10-13 hairs along the posterior margin, 39-42  $\mu$  long. Gonapophyses two, each with 3-5 hairs, 10-14  $\mu$  long. The abdomen with on each side four spiracles, on segments II-V.

Larvae.— Larvae are of two types: 1. Larvae, three stages which grow into apterae, the body dorsally with a sclerotic plate on head plus pronotum, and on tergites I-VIII, without button organs. 2. Larvae, four stages with on each segment four sclerites with one or two button organs; these larvae grow into alatae. One larval stage of each type is described below.

3. First stage larva of apterous viviparous female (subspecies *rotifera* Hille Ris Lambers and Takahashi, 1959, legit. F.W. Rappard, 12.v.1950, no. 188). In life pale brownish (Van der Goot, unpublished) or transparent olive green (F.W. Rappard, unpublished), without fringe of wax.

Macerated specimens.— (fig. 520; description of one specimen). Body length 325  $\mu$ , 1.7 times as long as it is wide, head fused with the prothorax, dorsally pale brown with some small pustules; mesothorax and metathorax free, pale brown but along the segmental borders colourless; abdominal segments I-VIII fused, pale brown, with some transverse stripes. Length of head plus pronotum 130  $\mu$ , width of the prothorax 176  $\mu$ ; head across the eyes 120  $\mu$ , with two frontal hairs, and four hairs in a row just anterior to the eyes, the marginal 33  $\mu$  long, the middle 10  $\mu$ , all slightly expanded at the tips; ventrally a pair of hairs, 30  $\mu$  long. Antennae with four segments, 88  $\mu$  long, segment III, 29  $\mu$ ; IV, 33  $\mu$  with smooth imbrications; length of hair on segment II, 33  $\mu$ , lacking on III, and four apical setae on segment IV, the longest 53  $\mu$ , the shortest 15  $\mu$ . Eyes brown. Prothorax with two marginal hairs, 32  $\mu$  long, with expanded tips, two  $\mu$  wide, and two hairs on the pronotum, 12  $\mu$  long. Meso- and metathorax each with two marginal hairs on each side, 23  $\mu$  and 19  $\mu$  long respectively, and each with a pair of dorsal hairs, 14  $\mu$  long. Tibiae with some smooth imbrications, the fore tibia 45  $\mu$  long, the tibia of the hind leg with a distal hair 27  $\mu$  long, and with two distal spines, the longest six  $\mu$ . All first tarsal segments with two hairs, of the hind leg 23  $\mu$  long. Second tarsal segment of the hind leg with two dorsoapical hairs with expanded tips, 32  $\mu$  long, the lateral hairs smaller but also with expanded tips. Abdominal segment I with one marginal hair, 20  $\mu$  long, and a pair of dorsal hairs, nine  $\mu$  long; segments II-VIII only with marginal hairs, one on each side, 20, 14, 14, 14, 15, 20 and 23  $\mu$  long respectively. Cauda with two hairs, 12  $\mu$  long. Spiracles lacking on the abdomen.

4. In the same collection, the first stage larva of apterae (3) which is described above, is a third stage larva close to moulting to an adult aptera; the larva has hairs on the head 45  $\mu$  long, the tip one  $\mu$  wide; prothorax marginally 27  $\mu$  long, tip 1-2  $\mu$  wide; metathorax marginally (fig. 521a) 53  $\mu$  long, the tip acute; abdominal segment I marginally 48  $\mu$  long, the tip one  $\mu$  wide; abdominal segments II-VII marginally 8-14  $\mu$  long and almost acute. The corresponding hairs of the adult inside are: head 20  $\mu$  long, tip fan-shaped 8  $\mu$  wide; prothorax 20  $\mu$  and 12  $\mu$  wide; metathorax (fig. 521b) 29  $\mu$  and 10  $\mu$  wide, abdominal segment I, 39  $\mu$  and 11  $\mu$  wide; segments II-VII, 2-4  $\mu$  long and almost acute.

5. Larvae growing into alatae, in life with a raised woolly fringe marginally, and dorsally in the middle wads of wax on presumably pro-, meso- and metanotum and the abdominal segments anterior to the siphunculi; marginally and dorsally in the wads long raised threads (notes of F.W. Rappard); Van der Goot (unpublished) writes: Body slightly pulverulent with transverse rows of small blackish patches, each surmounted by a glassy wax-rod.

Macerated specimen.— Third stage larva of alata (fig. 522; button organ figs. 523, 524 of fourth stage larva; description of one specimen; leg. P. v.d. Goot, 20.viii.1915; fig. button organ leg. F.W. Rappard, 12.v.1950). Body 1.00 mm long. The head pale brown, up to the level of the base of the antennae with two frontal hairs, 80  $\mu$  long; the margin of the frons anterior to the eyes with four hairs 98  $\mu$  long; between the eyes a pair of hairs 88  $\mu$  long. Between the eyes an anterior and a posterior pair of button organs, 16-18  $\mu$  wide; along the margin of the frons a pair of button organs with a diameter of eight  $\mu$ . Antennae pale brown, with five segments, 240  $\mu$  long; segment II with a hair, 25  $\mu$  long; segment III, 84  $\mu$  long, without hairs; segment IV, 49  $\mu$  long with a rhinarium, without hairs; segment V, 53  $\mu$  long, the processus terminalis 18  $\mu$ , without hairs but with two apical setae, 17  $\mu$  long. Prothorax marginal sclerite with two hairs and 2-3 button organs, one of these larger with a diameter of 18-19  $\mu$ ; dorsally four hairs, without button organs. Mesothorax with a marginal sclerite with two hairs, and 2-3 button organs; dorsally two sclerites, altogether with three hairs and two button organs. Metathorax marginal sclerite with two hairs, 82  $\mu$  long, and with one button organ, dorsally with two sclerites altogether with four hairs and one button organ. Hind leg brown, but claws colourless; first and second tarsal segments separate. Marginal sclerites of abdominal segments I-IV each with one hair and 1-2 button organs, the largest with a diameter of 16  $\mu$ ; segment I dorsally with three hairs, II and III dorsally each with a pair of sclerites without hairs, each with a button organ, 16-18  $\mu$  wide; IV dorsally with a sclerite with one button organ, on the other side with one hair only. The marginal sclerites of segments V and VI fused, with the siphunculi on segment V with a pore 22  $\mu$  wide, and each sclerite with two hairs and two button organs; dorsally segments V and VI each on one side with a sclerite with a button organ, which are lacking on the other side; segment VII with a marginal sclerite only. Tergite VIII a sclerite with two hairs.

6. Most embryos inside the alatae described above are of the same type as the larvae growing into alatae under 5 already described. One embryo is 325  $\mu$  long, length of an apical hair of the antenna 51  $\mu$ , length of hair with an expanded tip marginally on abdominal segments I-VII, 23, 14, 13, 12, 12, 20 and 26  $\mu$  long respectively, and close to each of these hairs a button organ with a diameter of 5-10  $\mu$ ; on tergite VIII two hairs with expanded tips, 25  $\mu$  long.

7. One embryo inside one of the two alatae has longer almost acute hairs, marginally on abdominal segments I-VII, 27, 27, 27, 33, 43, 35 and 33  $\mu$  long respectively, and no button organs are observable; on tergite VIII two hairs, almost acute, 37  $\mu$  long.

Host plant records.— Specimens were collected in Java 1. From *Distylium stellare* O.K., Kadjar, Dieng (1500-2560 m), beginning of April 1915, 20.viii.1915, leg. P. van der Goot; conical gall IV, Dieng x.1957, 29.viii.1957, leg. Harjono, all in the collection at the British Museum (Natural History), Londen; Dieng (2000 m), 31.xii. 1976, leg. D. Noordam, in the collection at the Rijksmuseum van Natuurlijke Historie,



Leiden. 2. From *Ficus* spp.: Salatiga (600 m), Djetak (Merbaboe, 800 m), Bandongan (Merbaboe, 1300 m) on *F. benjamina* L. *F. septica* Burm.f., *F. drupacea* Thunb., among others 18.vi.1916, leg. P. van der Goot, in the collection at the Laboratorium voor Entomologie, Wageningen (unpublished data; *Ficus* spec., Salatiga, Semarang, 20.xii.1916, leg. P. van der Goot, in the collection at the British Museum (Natural History), London; *Ficus* spec., Idjen plateau (900 m), 12.xi.1949; *Ficus?* *pruniformis* (*F. depressa* Bl.), Mandiku (70 m), 12.v.1950; *Ficus benjamina* L., Gadungan-Kediri, (250 m), 28.v.1951, all leg. F.W. Rappard, no. 153, 188, 305 respectively, in the collection at the British Museum (Natural History), London.

The aphids, fundatrix with next generations and the fundatrigeniae live in leaf galls of *D. stellare*. There is some confusion concerning the type of gall described by Van der Goot (1917), Docters Van Leeuwen-Reijnvaan and Docters Van Leeuwen (1926), and Hille Ris Lambers and Takahashi (1959). According to Hille Ris Lambers and Takahashi gall no. 4 of *R. distylii* is conical or elevated fingertip-like, brownish green. The exules live on the lower side, but sometimes also on the upperside (Van der Goot unpublished) of the leaves of *Ficus* spp., dispersed over the surface.

Etymology.— *Distylii*, of *Distylium*, name applied to this species by Van der Goot (1917).

#### Genus *Schizoneuraphis* Van der Goot, 1917 (figs. 525 - 565)

*Schizoneuraphis* Van der Goot, 1917: 245 (type species *Schizoneuraphis gallarum* Van der Goot, 1917).

In this genus three species are included: *S. gallarum* Van der Goot, 1917, *S. litseicola* spec. nov. and *S. longisetosa* spec. nov. The species *S. distylii* Van der Goot, 1917 was transferred by Hille Ris Lambers & Takahashi (1959) to the genus *Reticulaphis* Takahashi, 1958; *S. foliorum* Van der Goot, 1917 is included in *Distylaphis* gen. nov. in the present publication.

Description (three species).— I. Morphs from galls of *Distylium stellare* O.K.

Apterous viviparous female.— (two species). In life: Dull greenish-brown with a flaky wax wad on the hind part of the abdomen, rather globular. Macerated specimens: Body colourless, almost without segmental borders, 0.86-1.54 mm long, 1.3-2.1 times as long as it is wide. The head smooth, anteriorly with six hairs, between the eyes with 4-6 hairs, the hairs thin, terminating in a thread, 55-196  $\mu$  long. Antennae with three or four segments, 185-244  $\mu$  long, 0.15-0.24 times as long as the body, and 0.51-0.84 times the distance between the outer margins of the eyes; the last antennal segment 2.7-4.0 or 7.2-10.4 times as long as its processus terminalis. The eyes with three ommatidia. Ultimate rostral segment without accessory hairs, 68-82  $\mu$  long, 0.93-1.25 times as long as the second tarsal segment of the hind leg; stylets 200-290  $\mu$  long. Meso- and metathorax each marginally with two hairs, dorsally with 11-15. Legs evenly brown, with a few spinulose imbrications; tibia of the fore leg 139-251  $\mu$  long, 0.53-0.85 times as long as the distance between the outer margins of the eyes. First tarsal segments of fore- and midleg with three hairs, of the hind leg with two. Second tarsal segments of the hind leg with two dorsoapical hairs, without expanded tips; empodial hairs of the hind leg 0-8  $\mu$  long. Abdomen colourless, with only a

segmental border between segments VII and VIII. Margins of the body anterior to the siphunculi, and in a medial area on segments I-IV with lines, somewhat like convolutions of the brain, observable at magnifications above 250; wax gland groups are lacking. One marginal hair on each side to what corresponds to segments I-VII, the hair on segment VI close to the siphunculus; tergite I with 1-11 hairs, II, 1-6, III, 2-4; IV, 3-4; V, 0-4; VI, 1-2; VII, 1-3; length of the hairs 51-186  $\mu$ . Siphunculi located on segment VI, the pore yellowish brown, with a diameter of 23-29  $\mu$ . Cauda transversely elongate, without a constriction, 84-178  $\mu$  wide, and about twice as wide as it is long, with 7-13 hairs, the longest 29-84  $\mu$ . Subanal plate entire with only an indistinct median incision, with 10-12 hairs, the longest 31-92  $\mu$ . Subgenital plate with 2-4 anterior, and 9-13 posterior hairs. Gonapophyses two, each with 1-10 hairs. Spiracles on the abdomen on segments I-V, those on I indistinct.

Alate viviparous female.— (fundatrigenia, *S. gallarum*). In life: Head and thorax black, abdomen dark green. Pterostigma greyish black. Macerated specimens (one species). Body length 1.6-2.2 mm. The head with blunt spinulae, without horns or dagger hairs, dorsal to the median ocellus three pairs of hairs, between the paired ocelli 2-4 hairs, and posterior to the paired ocelli six hairs, 35-49  $\mu$  long. Antennae with five segments, 0.27-0.41 times as long as the body, and 1.4-1.7 times the width of the head across the eyes; the processus terminalis 23-30  $\mu$  long. Antennal segments III-V with ring-shaped secondary rhinaria; the primary rhinaria located distally to the annular rhinaria of segments IV and V, are annular and slightly wider than the secondary rhinaria; segment III with 17-22 annular rhinaria, IV with 8-11, V with 4-8. The last rostral segment 102-113  $\mu$  long, 0.82-0.95 times as long as the second tarsal segment of the hind leg, without accessory hairs; length of the stylets 315-335  $\mu$ . Eyes compound. Fore wing medial vein once branched, the hind wing with two oblique veins. Femora, tibiae and second tarsal segments with spinulose imbrications; the tibia of the fore leg 505-565  $\mu$  long, 1.2-1.4 times as long as the width of the head across the eyes; first tarsal segments of the fore leg with 3-4 hairs, of the midleg with three, of the hind leg with two. Second tarsal segment of the hind leg with four apical hairs with expanded tips. Abdominal segments I-VI colourless, smooth, dorsally segments I and II with 5-6 hairs, III-V with 3-5, VI with 2-3; segment VII with a pale brown transversely elongate band dorsally with 2-3 hairs. Tergite VIII a pale brown transverse elongate plate with 8-11 hairs, 60-72  $\mu$  long. Siphunculi situated on segment VI, the pore 40-50  $\mu$  wide. Cauda at the base 118-149  $\mu$  wide, without a constriction, with 7-10 hairs, 55-62  $\mu$  long. Subanal plate bilobed, with 16-19 hairs, 69-72  $\mu$  long. Subgenital plate with 8-11 anterior, and 11-17 posterior hairs. Gonapophyses two, each with 5-10 hairs, 20-23  $\mu$  long.

Alate viviparous female (emigrant), see *S. longisetosa*.

First stage larva of aptera.— Antenna with four segments, apical setae of the last segment 14-22  $\mu$  long. Groups of wax glands are lacking. Hairs up to 80  $\mu$  long. Siphunculi are present, diameter of the pore 14-18  $\mu$ .

Embryos of alate viviparous females with stout marginal and dorsal hairs, 72-118  $\mu$  long and near the base 4-5  $\mu$  wide. Abdominal segments I-VII marginally with one hair on each segment, dorsally a pair of hairs on segment I, but lacking on segments II-VII. Siphunculi present.

II. Morphs from *Litsea* Lamk.

Apterous viviparous female.— (two species). In life: Shiny dark brown or black

with pale brown antennae and legs. The almost perpendicular sides with a white band of wax.

Macerated specimens.— Body pale brown or brown, with three parts separated from each other by furrows or membranes: (1) prosoma, the fused head, thorax and abdominal tergite I, an almost flat plate, not sunk in the middle, smooth, but pustules along furrows and around muscular plates; (2) the complex of tergites II-VII, the lateral and posterior margin thickened, and both with a crest; (3) segment VIII free, the lateral and posterior margins thickened and with a crest. The prosoma is 2.6-3.9 times as long as the complex II-VII, and 6.4-8.4 times as long as tergite VIII. Length of the body 685-875  $\mu$ , 1.1-1.7 times as long as it is wide. The head without horns or dagger hairs, with two anterior, and four posterior stout interocular hairs, the longest 90-150  $\mu$ , and six  $\mu$  wide near the base. The pro-, meso-, metathorax and abdominal segment I on each side with 2, 2-3, 2-3, 1-2 stout hairs, next to in *S. litseicola* a number of small hairs; dorsally on each of these segments two stout hairs, next to a number of small hairs in *S. litseicola*; the stout hairs 100-180  $\mu$  long, and 7-12  $\mu$  wide near the base, the small hairs 30-80  $\mu$  long. Antennae with three or four segments, more or less fused, bent sideways on segments I and II, 123-153  $\mu$  long, 0.16-0.18 times as long as the body, and 0.52-0.66 times the distance between the outer margins of the eyes; the distal rhinarium located 6-8  $\mu$  from the tip, the other 36-47  $\mu$ . Eyes with three ommatidia. Ultimate rostral segment without accessory hairs, 61-78  $\mu$  long, 1.35-1.56 times as long as the second tarsal segment of the hind leg; length of the stylets 232-288  $\mu$ . Spiracles on each side, one between fore- and midleg and one between mid- and hind leg. The legs pale brown, the tibia of the fore leg 94-114  $\mu$  long, 0.37-0.51 times as long as the distance between the outer margins of the eyes. First tarsal segments of fore- and midleg with three, of the hind leg with two hairs. The lateral sides of complex II-VII with 3-6 hairs, some of which are stout, some small. Posteromedial to the siphunculi two stout hairs, and anterior to the siphunculi in *S. litseicola* 2-6 small hairs. Siphunculi apparently on segment VI, 18-25  $\mu$  wide with an opening of 6-10  $\mu$ . Tergite VIII with two stout hairs in the middle, 102-125  $\mu$  long, and lateral to these usually one small hair, 32-61  $\mu$  long. Cauda with a knob and a constriction, transversely elongate, 46-59  $\mu$  wide and 20-22  $\mu$  long, with 7-11 hairs, the longest 45-57  $\mu$ . Subanal plate bilobed, with 12-13 hairs, 49-74  $\mu$  long. Subgenital plate with two anterior, and 8-16 posterior hairs. Gonapophyses two, each with 1-3 hairs, 6-11  $\mu$  long. Spiracles are lacking on the abdomen.

First stage larva of aptera.— Antennae with three or indistinctly four segments, apical setae 12-22  $\mu$  long. Groups of wax glands are lacking. Siphunculi are present. Spiracles on each side two, on the thorax only.

Alate viviparous female (one species). In life blackish brown with pale brown legs. Pterostigma grey. Macerated specimens: Body length 1.1-1.3 mm. The head smooth, without horns or dagger hairs, anteriorly with three pairs of hairs, posteriorly with four hairs, 27-41  $\mu$  long, 0.09-0.11 times as long as the width of the head across the eyes. Antennae with five segments, 0.46-0.51 times as long as the body, and 1.6-2.0 times the width of the head across the eyes, the processus terminalis 8-18  $\mu$  long. Antennal segments III-V with ring-shaped secondary rhinaria; the primary rhinaria are moulded with the secondary rhinaria to a complex structure, or distally on segment V observable as a separate oval structure; segment III with 13-17, IV with 7-9, V with 4-6 annular rhinaria. The last rostral segment 67-83  $\mu$  long, 0.97-1.02 times

as long as the second tarsal segment of the hind leg, without accessory hairs; length of the stylets 215-266  $\mu$ . Eyes compound. Fore wing the medial vein once branched, the hind wing with two oblique veins. Femora, second tarsal segments, and especially the tibiae with spinulose imbrications. The tibia of the fore leg 271-322  $\mu$  long, 0.87-1.00 times as long as the width of the head across the eyes; first tarsal segments of fore- and midleg with three, of the hind leg with two hairs. Second tarsal segment of the hind leg with four apical hairs with expanded tips. Abdominal segments I-VI colourless, with on some segments a small marginal pale brown plate, with or without a hair, 35-60  $\mu$  long; dorsal hairs are lacking; segment VII with a marginal sclerite with one hair, sometimes fused with the dorsal transverse elongate plate with two hairs, 59-88  $\mu$  long. Tergite VIII a brown transverse elongate plate with two hairs, 56-84  $\mu$  long, and lateral to these usually a smaller hair. Siphunculi situated on segment VI, the pore 30-33  $\mu$  wide. Cauda a knob with a rather indistinct constriction, 57-61  $\mu$  wide, 25-30  $\mu$  long, with 10-12 hairs, the longest 43-55  $\mu$ . Subanal plate bilobed, with 12-15 hairs, the longest 63-76  $\mu$ . Subgenital plate with 4-10 anterior, and 10-13 posterior hairs. Gonapophyses two, each with 4-6 hairs, the longest 8-16  $\mu$ . Spiracles on abdominal segments III and V, in one specimen on IV only.

Embryos from alatae are of two types: (1) similar to first stage larvae of apterae, with stout hairs, and (2) with marginal hairs, 12-25  $\mu$  long, and close to each hair from prothorax to abdominal segment VII a disc-shaped organ with a diameter of 10-12  $\mu$ , and 4  $\mu$  high. Siphunculi on segment VI, the pore with a diameter of 12  $\mu$ .

Etymology.— *Schizoneuraphis*, aphid with split veins, name given by Van der Goot (1917), referring to the fact that the cubitus and anal vein are split at their bases, or are fused only for a short distance, as Van der Goot mentions.

### ***Schizoneuraphis gallarum* Van der Goot, 1917** (figs. 525-549)

*Schizoneuraphis gallarum* Van der Goot, 1917: 252; Hille Ris Lambers & Takahashi, 1959: 4.

*Thoracaphis hongkongensis* Van der Goot, 1918: 124; Eastop & Hille Ris Lambers, 1976: 391 (synonymy).

*Metanipponaphis hongkongensis*; Tao, 1966: 176 (classification).

Types.— Lectotype of *S. gallarum* (apterous viviparous female, here designated) from inside the gall of *Distylium stellare* O.K., Prahoe-Dieng, 20.viii.1915, leg. P. van der Goot, no. 179-3, det. P. v. d. Goot: *Schizoneuraphis gallarum*. Paralectotypes: two apterae viviparae with the same data as the lectotype. Lectotype and paralectotypes in the collection at the Laboratorium voor Entomologie, Wageningen. Fundatrigeniae, alatae from the galls of *Distylium stellare*, Dieng, x.1957, leg. Harjono, in the collection at the British Museum (Natural History), London, Hille Ris Lambers & Takahashi (1959).

Introduction.— Van der Goot (1917) described *Schizoneuraphis gallarum* from galls of *Distylium*. To the description of apterae and alatae he also added a description of alatae collected from leaves of *Distylium* and suggested that these were returning to the primary host ("remigranta"); I think that these alatae, with the drawing B of a wing, do not belong to *S. gallarum*, but probably to *Distylaphis foliorum* (Van der Goot, 1917). Hille Ris Lambers & Takahashi (1959) state that the embryos inside alate fun-

datrigeniae from *D. stellare* are exactly like embryos and first instar larvae of an aphid of *Litsea*, and they consider these aphids to be *S. gallarum*; there are however important differences between these larvae, but nevertheless due to the lack of a good alternative the views of Hille Ris Lambers & Takahashi are held here. Some specimens of the apterae collected by Van der Goot from which he made his descriptions still exist and these are chosen as lectotype and paralectotypes.

I. Morphs from *Distylium stellare* galls.

1. Apterous viviparous female.— In life: Rather globular, dull greenish-brown, with behind a flaky wax wad on the abdomen. Larvae yellowish white.

Macerated specimens.— (figs. 525, 526; described from six specimens). Body length 0.86-1.05 mm.

Head.— Head colourless, dorsally smooth, distance between outer margins of eyes 270-295  $\mu$ , anteriorly with six hairs, and between the eyes six hairs, thin terminating in a thread, 55-63  $\mu$  long. Antennae pale brown, with four segments, 185-222  $\mu$  long, 0.18-0.24 times as long as the body, 0.51-0.72 times the distance between the outer margins of the eyes; segments I and II almost smooth; III, 88-101  $\mu$  long, with imbrications looking somewhat rough due to minute spinulae, about half a  $\mu$  long, without hairs, 1.9-2.2 times as long as segment IV. Segment IV, 40-48  $\mu$  long, with imbrications as segment III, without hairs, but with four apical setae 14-16  $\mu$  long, the processus terminalis 10-18  $\mu$  long. Eyes brown, with three ommatidia with a diameter of 12  $\mu$ . Ultimate rostral segment 68-73  $\mu$  long, 1.05-1.25 times as long as the second tarsal segment of the hind leg; stylets 200-255  $\mu$  long.

Thorax.— The pronotum colourless, fused with the head, on each side two marginal hairs and 2-4 dorsal hairs in the medial area along the posterior margin. Mesothorax and metathorax colourless without segmental borders, each with two marginal hairs, and 13-15, and 11-13 respectively dorsal hairs. Legs evenly brown; the coxae, femora, tibiae and second tarsal segments with some spinulose imbrications, the spinulae not more than one  $\mu$  long. Tibia of the fore leg 139-155  $\mu$  long, 0.51-0.56 times as long as the distance between the outer margins of the eyes. First tarsal segments of fore- and midleg with three hairs, of the fore leg the lateral hairs 6-8  $\mu$  long, the middle 12-16  $\mu$ , the lateral hairs 0.37-0.67 as long as the middle; of the hind leg with two hairs, 8-12  $\mu$  long. Second tarsal segments of the hind leg 0.25-0.29 times as long as the tibia of the hind leg and 0.21-0.24 times as long as the distance between the outer margins of the eyes, with two dorsoapical hairs without expanded tips, 25-33  $\mu$  long. Empodial hairs of the hind leg 0-4  $\mu$  long. Length of the segments of the hind leg: femur plus trochanter 236-245  $\mu$ , tibia 226-240  $\mu$ , 0.93-1.00 times as long as the femur, and 0.79-0.87 times as long as the distance between the outer margins of the eyes, first tarsal segment 27-29  $\mu$ , second tarsal segment 49-53  $\mu$ .

Abdomen.— Abdomen colourless, the segments fused and only a segmental border between segments VII and VIII. Margins of the body anterior to the siphunculi up to between the marginal hair of segments I and II with lines (fig. 526), somewhat like convolutions of the brain, observable at magnifications above 250; the convolutions are also present in a medial area from segments I to IV, but are lacking pleurally and ventrally; the tergum of segments V-VIII with spinulose imbrications. One marginal hair on each side to that corresponding with segments I-VII, the hair on segment VI close to the siphunculus; tergite I with 8-11 hairs, II with 6; III, 3-4; IV, 3-4; V, 2-4; VI, 1-2; VII, 1-2; length of dorsal hairs 35-60  $\mu$ , of ventral hairs 30-40  $\mu$ .

Tergite VIII with 6-10 hairs, 51-65  $\mu$  long. Siphunculi located dorsally on segment VI, colourless, 10-12  $\mu$  high, 30-40  $\mu$  wide at the base, with some concentrically arranged wrinkles; the pore yellowish brown, diameter of the pore 23-28  $\mu$ , without a rim. Cauda transversely elongate, without a constriction, e.g. 96  $\mu$  wide at the base, and 57  $\mu$  long, but the part with distinct spinulae only 40  $\mu$  long; at the base 84-105  $\mu$  wide, with 7-8 hairs, the longest 29-40  $\mu$ . Subanal plate entire with only an indistinct median incision, with 10-12 hairs, the longest 31-43  $\mu$ . Subgenital plate with conspicuous spinulose imbrications, with 2-3 anterior hairs, 42-53  $\mu$  long, and 9-12 posterior hairs, 53-60  $\mu$  long. Gonapophyses two, each with 2-5 hairs, the longest 10-14  $\mu$ .

2. Alate viviparous female (emigrant).— In life: Head, thorax, eyes antennae and legs black; pterostigma of the fore wing blackish (Van der Goot, 1917).

Macerated specimens.— (figs. 527-534; described from 10 specimens). Body length 1.61-2.16 mm, 1.7-2.1 times as long as it is wide.

Head.— (fig. 527). Head black, with blunt spinulose of about one  $\mu$  diameter, and close to the paired ocelli some flat ridges; width across the eyes 395-435  $\mu$ , dorsal to the median ocellus three pairs of hairs, between the paired ocelli 2-4 hairs, and posterior to the paired ocelli six hairs, 35-49  $\mu$  long. Ventrally, posterior to the median ocellus 10-15 hairs. Antennae brown, with yellowish brown rings, with five segments, 620-700  $\mu$  long, 0.27-0.41 times as long as the body, and 1.4-1.7 times the width of the head across the eyes; segment I somewhat wrinkled; segment II (fig. 528) with wrinkles and especially on the ventral side arranged as a network, with some spinulae; segments III-V (fig. 529) with ring-shaped secondary rhinaria, the rings are not closed on the dorsal side, most rings with a wide interval of 10-25  $\mu$ ; between the rhinaria are 3-8 concentric spinulose imbrications, especially dorsally waved finely, dorsally and ventrally with interconnections; the rhinaria are 2-3  $\mu$  wide. The primary rhinarium on segments IV and V is located distally to the secondary rhinaria, is annular and slightly wider than the secondary rhinaria, and on segment V with one or more rather circular accessory rhinaria; segment III with 17-22 annular rhinaria, IV with 8-11, V with 4-8; hairs on segments III-V lacking, but on segment V four apical setae, 12-18  $\mu$  long. Length of segment III, 260-291  $\mu$ , 1.6-1.9 times as long as IV, 1.8-2.3 times as long as V, and 0.9-1.0 times as long as IV plus V; segment IV, 141-174  $\mu$  long, 1.0-1.3 times as long as V; segment V, 125-161  $\mu$  long, the processus terminalis 23-30  $\mu$ , only half as wide as the basal part of segment V. The last rostral segment 102-113  $\mu$  long, 0.82-0.95 times as long as the second tarsal segment of the hind leg, without accessory hairs; length of the stylets 315-335  $\mu$ . Eyes black, the ocular tubercle extending sideways about 25  $\mu$ .

Thorax.— Sides of the prothorax blackish, mesothorax black. Fore wing (fig. 530) distal part of the radial sector running straight to the tip of the wing, medial vein once branched, the anal vein straight, bordered by a narrow pale brown zone; the cubitus brown with a narrow pale brown zone and starting with a colourless base at the anal vein, 50-100  $\mu$  from the subcosta; the hind wing with two oblique veins. Legs brown, the basal part of the fore femora paler, the knees and sometimes the distal part of the tibiae darker; femora, second tarsal segments, and especially the tibiae with spinulose imbrications, the spinulae 1-3  $\mu$  long; the tibia of the fore leg 505-565  $\mu$  long, 1.2-1.4 times as long as the width of the head across the eyes, length of the hairs of the hind tibia 37-41  $\mu$ ; chaetotaxy of first tarsal segments 3-4, 3, 2, the lateral hairs of the fore tarsus 2.9-3.2 times as long as the middle hairs, length of hairs of the

first tarsal segment of the hind leg (fig. 531) 49-60  $\mu$ ; the four apical hairs of the second tarsal segment of the hind leg (fig. 532) with expanded tips, the dorsal hairs 59-61  $\mu$  long, the tips four  $\mu$  wide; empodial hair of the hind leg 29-35  $\mu$  long, with an expanded tip. Length of the hind segments: femur fused with trochanter 488-496  $\mu$ , tibia 708-715  $\mu$ , 1.43-1.45 times as long as the femur, and 1.66-1.73 times the width of the head across the eyes; first tarsal segment 37-39  $\mu$  long, second tarsal segment 113-128  $\mu$ .

Abdomen.— (fig. 533). Abdominal segments I-VI colourless, smooth with marginally on each segment one hair, 53-70  $\mu$  long, dorsally segments I and II with 5-6 hairs; III-V, 3-5; VI, 2-3; the hairs dorsally on segment IV, 49-55  $\mu$  long, ventrally 33-40  $\mu$ . Segment VII with a pale brown, narrow transverse elongate band, with spinulose imbrications, with one hair marginally, and 2-3 dorsal hairs. Tergite VIII a pale brown transverse elongate plate, e.g. 88  $\mu$  long, and 267  $\mu$  wide, with broadly rounded posterior margin, with spinulose imbrications, with 8-11 hairs, all of about the same size, 60-72  $\mu$  long. Siphunculi situated on segment VI, 80-100  $\mu$  wide, pale brown, with some concentric wrinkles; the pore brown, 40-50  $\mu$  wide, on about the same plane as the surroundings. Cauda (fig. 534) at the base 118-149  $\mu$  wide, without a constriction, a plate with a straight posterior margin with spinulae and spinulose imbrications, and more ventrally a broadly rounded margin protruding backwards 10  $\mu$  further on than the straight posterior margin, with 7-10 hairs, 55-62  $\mu$  long. Subanal plate bilobed, with 16-19 hairs, 69-72  $\mu$  long. Subgenital plate with 8-11 anterior hairs, 55-57  $\mu$  long, and 11-17 posterior hairs, 59-65  $\mu$  long. Gonapophyses two, each with 5-10 hairs, 20-23  $\mu$  long. The abdomen on each side with four spiracles, on segments II-V.

3. First (probably) stage larva of apterous viviparous female (fig. 535) from galls of *Distylium stellare* (description of one specimen). The body colourless, 590  $\mu$  long. Distance between the outer margins of the eyes 208  $\mu$ . The frons dorsally with four hairs, 90  $\mu$  long, between the eyes six hairs up to 95  $\mu$  long. Antennae with four segments, 137  $\mu$  long; segment II smooth, with a hair, 20  $\mu$  long; segment III, 53  $\mu$  long, with a few almost smooth imbrications, without hairs; IV, 38  $\mu$  long with imbrications with fine spinulae, without hairs, but with four apical setae, 14  $\mu$  long, the processus terminalis 14  $\mu$  long. The legs pale brown, smooth, but the second tarsal segments with a few imbrications; tibia of the fore leg 102  $\mu$  long, 0.49 times as long as the distance between the outer margins of the eyes; length of distal hairs of the hind tibia, 23  $\mu$ . All first tarsal segments with two hairs, of the hind leg, 20  $\mu$  long. Two dorsoapical hairs of the second tarsal segment, acute, 33  $\mu$  long. Dorsal thoracic hairs up to 100  $\mu$  long, hair on tergite VIII, 48  $\mu$  long. Cauda with two hairs, 30  $\mu$  long. Siphunculi present, the pore 22  $\mu$  wide.

Embryos inside alate viviparous females are of one type, quite different from first stage larvae of apterae from *Distylium* and roughly similar to first stage larvae of apterae from *Litsea*. A description of these embryos follows below.

4. Embryo inside alate from *D. stellare* (fig. 536): Body length 500-550  $\mu$ . The head anterior to the eyes with two pairs of hairs, between the eyes six hairs, 118  $\mu$  long, and 4-5  $\mu$  wide close to the base. Antennae with four segments, 198  $\mu$  long, segment III with smooth imbrications, 61  $\mu$  long, without hairs; IV with smooth imbrications, 78  $\mu$  long, without hairs, but with four apical setae, 18  $\mu$  long. Stylets 425-475  $\mu$  long. Prothorax marginally on each side two hairs, and dorsally two hairs. Meso- and

metathorax each with two hairs on each side, 100-110  $\mu$  long, and two dorsal hairs, 105-110  $\mu$ . Two dorsoapical hairs of the second tarsal segment of the hind leg 53  $\mu$  long, with expanded tips, two  $\mu$  wide. Abdominal segment I with a stout marginal hair, 104  $\mu$  long, and two dorsal hairs, 102  $\mu$  long; segments II-VII on each side with six hairs of about equal size, 72-100  $\mu$  long and four  $\mu$  wide close to the base; one of these hairs is located, maybe on segment VI, just posterior to the siphunculi slightly more pleural and points to the middle, while the other hairs point backwards; dorsally hairs are lacking on segments II-VII; segment VIII with two spinal hairs, 76-92  $\mu$  long. Siphunculi presumably on segment VI, the base with a diameter of 35  $\mu$ , the pore 20  $\mu$  wide. Cauda with two hairs, 40  $\mu$  long.

## II. Morphs from *Litsea* Lamk.

1. Apterous viviparous female.— (exul). In life (pl. 48): Shiny dark brown or black, antennae and legs pale brown, eyes black. The almost perpendicular sides just ventral to the rather flat dorsum with a white band of wax, which widens to the ventral side between fore- and midleg, and between mid- and hind leg to a small column of wax; the dorsum with some rather indistinct patches of wax. The dorsum with upright pale brown hairs. Larvae dull orange brown, with some granular wax, the upright hairs almost white.

Macerated specimens.— (figs. 537, 538; described from nine specimens). Body pale brown or brown, obovate, 685-875  $\mu$  long, 1.3-1.5 times as long as it is wide, with three parts separated from each other by furrows or membranes: (1) head plus thorax plus abdominal tergite I (prosoma) an almost flat plate, the margins of which curve towards the ventral side and overlap the dorsal part of the sides of thorax and abdominal tergite I; the prosoma with four pleural pairs of intermuscular plates transversely connected by furrows; the intermuscular plates and furrows are both marked by pustules, the rest of the prosoma is smooth. A fifth distal furrow with pustules surrounds the anterior and lateral sides of part (2), the tergites II-VII, a complex with the posterior margin thickened, and the lateral and posterior margin with a crest; (3) segment VIII free, the lateral and posterior margins thickened and with a crest. (1) is 2.6-3.9 times as long as (2), and 6.4-8.1 times as long as (3).

Prosoma.— The areas with stout hairs and also the eyes are almost at the same height, smooth, gradually sloping down to the five transverse furrows which are not membranous, but provided with oval pustules, 2-4  $\mu$  high with a diameter of 10-20  $\mu$ . Pleurally the furrows end in intermuscular plates which are surrounded by the same type of pustules; these plates and the pleural area between the plates are located about 40  $\mu$  below the areas with stout hairs. Also some submarginal muscular plates are observable. The frons dorsal to the antennae with two hairs, about 40  $\mu$  long, two anterior and four posterior interocular hairs, the longest 90-123  $\mu$  and about six  $\mu$  wide near the base. Eyes with three ommatidia, distance between the outer margins of the eyes 200-255  $\mu$ , and width of the head across the eyes 236-425  $\mu$ . Antennae pale brown, segment III colourless, inserted 30-50  $\mu$  below the eyes, with three or more rarely four segments, bent sideways on segment I, 123-153  $\mu$  long, 0.16-0.18 times as long as the body, and 0.56-0.66 times the distance between the outer margins of the eyes; base of segment I fused with the head, length 20-27  $\mu$ , with a hair 6-15  $\mu$  long, segment II, 22-27  $\mu$  long, with a hair 10-18  $\mu$  long; in antennae with three segments, segment III, 94-110  $\mu$  long, the distal rhinarium located 6-8  $\mu$  from the tip, the penultimate rhinarium 41-47  $\mu$ ; III with two apical setae, 10-13  $\mu$  long,



without other hairs; in antennae with four segments III, 62-80  $\mu$  long, IV, 30-43  $\mu$ . Ultimate rostral segment 61-67  $\mu$  long, 1.35-1.51 times as long as the second tarsal segment of the hind leg, length of the stylets 232-288  $\mu$ . Prothorax on each side two hairs, and two dorsal hairs, meso- and metathorax on each side with three marginal hairs, and with two dorsal hairs, abdominal segment I with two marginal hairs on each side, and two dorsal hairs; all hairs stout about 100-160  $\mu$  long and 7-12  $\mu$  wide near the base.

Abdominal segments II-VII. Area of segments II and III with transversely arranged rather flat oval pustules, marking a furrow between segments I-II proceeding into the margin, and a furrow between II and III proceeding to the pleural area only; the posterior part of the complex smooth with some spinulose imbrications only. The lateral sides ventrally with a crest 15-20  $\mu$  wide and dorsally with a longitudinal row of 3-6 hairs, always present on segments II and III, apparently lacking frequently on segments IV and V, but rarely on VI and VII; length of hairs on II, 95-145  $\mu$ , on III, 120-145  $\mu$ ; IV, 15  $\mu$ ; V, 15  $\mu$ ; VI, 45-75  $\mu$ ; VII, 60-110  $\mu$ . Abdominal segment II submedian sometimes with one stout hair, VII always with two submedian stout hairs. The crest ventral to the thickened posterior margin of segment VII, 10-12  $\mu$  wide. Siphunculi apparently on segment VI in a somewhat lowered area, a thickened ring, 18-22  $\mu$  wide, the pore with a diameter of 6-10  $\mu$ . Abdominal segment VIII dorsally free, a brown plate, 2.1-2.4 times as wide as it is long, with the middle area raised 20-30  $\mu$  to the lateral margins, with some irregular wrinkles and spinulose imbrications, the posterior margin broadly rounded with a horizontal radially striped crest, 10-15  $\mu$  wide, with ventral to the crest a thickened ridge, 6-8  $\mu$  wide. Submedian, two stout hairs, 106-129  $\mu$  long, and about eight  $\mu$  wide at the base, and pleurally on one or usually both sides a hair, 32-50  $\mu$  long, and 2  $\mu$  wide at the base; in one specimen both pleural hairs are lacking. The sides ventral to the prosoma with a band of pustules (fig. 538), wax glands, especially distinct close to the spiracula, with an irregular network structure; the pale brown sides with laterally on each side about six hairs, 35-50  $\mu$  long, continue to the ventral flat colourless plate, on which no hairs are observable. Legs pale brown, fore legs inserted at about 80-120  $\mu$  below the dorsum; tibia of the fore leg 94-114  $\mu$  long, 0.37-0.51 times as long as the distance between the outer margins of the eyes. First tarsal segments of fore- and midleg with three hairs, the lateral 1.0-1.9 times as long as the middle, of the hind leg with two hairs, 20-25  $\mu$  long; second tarsal segment of the hind leg 0.29-0.33 times as long as the tibia of the hind leg, and 0.19-0.21 times as long as the distance between the outer margins of the eyes, with two dorsoapical hairs, 31-37  $\mu$  long, with expanded tips, about one  $\mu$  wide. Empodial hairs of the hind leg rarely present. Length of the hind segments: femur fused with trochanter 112-127  $\mu$ , tibia 137-159  $\mu$ , 1.18-1.30 times as long as the femur, and 0.61-0.69 times the distance between the outer margins of the eyes, first tarsal segment 18-27  $\mu$ , second tarsal segment 43-47  $\mu$ . Spiracles about 70  $\mu$  ventral to the prosoma, on each side one between fore- and midlegs, and one between mid- and hind legs, abdominal spiracles are lacking. Cauda colourless, at the base 67-80  $\mu$  wide, with a knob 47-59  $\mu$  wide and about 22  $\mu$  long, the constriction with a diameter of 40-45  $\mu$ , with 10-11 hairs, the longest 45-57  $\mu$ . Subanal plate colourless, bilobed with 12-13 hairs, 59-74  $\mu$  long. Subgenital plate with two anterior hairs, 27-40  $\mu$  long, and 8-13 posterior hairs, 31-43  $\mu$  long. Gonapophyses two, each with 1-3 hairs, 6-11  $\mu$  long.

2. Alate viviparous female.— In life: Head brown, body blackish brown. Eyes black. Legs pale brown. Wings lie flat on the body. Pterostigma grey. Larvae dull orange brown, wing-pad pale; underside of body with wax.

Macerated specimens.— (figs. 540-546; described from six specimens). Body length 1.06-1.27 mm, 1.9-2.2 times as long as it is wide.

Head.— (fig. 540). Head black, smooth, with especially close to the paired ocelli, rather flat ridges; width across the eyes 285-365  $\mu$ , anterior to the paired ocelli three pairs of hairs, posterior four hairs, 27-41  $\mu$  long, 0.09-0.11 times as long as the width of the head across the eyes. Ventrally, posterior to the median ocellus 6-9 hairs. Antennae brown, with black rings, with five segments, 520-610  $\mu$  long, 0.46-0.51 times as long as the body, and 1.6-2.0 times the width of the head across the eyes; segment I somewhat wrinkled, segment II with wrinkles arranged as an irregular network with some spinulae; segments III-V (fig. 541) with ring-shaped secondary rhinaria, the rings are not closed on the dorsal side, with a space of 15-40  $\mu$ ; between the rhinaria are 3-6 concentric spinulose imbrications, dorsally and ventrally with interconnections; the rhinaria are 3-4  $\mu$  wide. The primary rhinaria are moulded with the secondary rhinaria to a complex structure; segment III with 13-17 annular rhinaria, IV with 7-9, V with 4-6; hairs on segments III-V lacking, but on segment V four apical setae, 10-12  $\mu$  long. Length of segment III, 232-280  $\mu$ , 1.7-2.0 times as long as IV, 2.1-2.7 times as long as V, and 1.0-1.1 times as long as IV plus V; segment IV, 118-150  $\mu$  long, 1.1-1.4 times as long as V; segment V, 88-115  $\mu$  long, the processus terminalis 8-18  $\mu$ . The last rostral segment (fig. 542) 67-83  $\mu$  long, 0.97-1.02 times as long as the second tarsal segment of the hind leg, without accessory hairs; length of the stylets 215-266  $\mu$ . Eyes black, the ocular tubercle extending sideways 20-25  $\mu$ .

Thorax.— Sides of the prothorax brown, mesothorax black. Fore wing (figs. 543, 544) medial vein once branched, the hind wing with two oblique veins. Legs brown, the femora and first tarsal segments slightly paler than the tibiae; femora, second tarsal segments, and especially the tibiae with spinulose imbrications, the spinulae 1-4  $\mu$  long; the tibia of the fore leg 271-322  $\mu$  long, 0.87-1.00 times as long as the width of the head across the eyes, length of the hairs of the hind tibia 22-27  $\mu$ ; chaetotaxy of first tarsal segments 3, 3, 2, the lateral hairs 2.4-3.2 times as long as the middle hairs, length of hairs of the first tarsal segment of the hind leg 40-43  $\mu$ ; the four apical hairs of the second tarsal segment of the hind leg (fig. 545) with expanded tips, the dorsal hairs 49-52  $\mu$  long, the tips four  $\mu$  wide; empodial hair of the hind leg 22-27  $\mu$  long. Length of the hind segments: femur fused with trochanter 232-287  $\mu$ , tibia 350-409  $\mu$ , 1.42-1.57 times as long as the femur, and 1.14-1.36 times the width of the head across the eyes; first tarsal segment 25-33  $\mu$  long, second tarsal segment 67-82  $\mu$ .

Abdomen.— (fig. 546). Abdominal segments I-VI colourless, with on some segments a small marginal pale brown plate, with or without a stout hair, 35-60  $\mu$  long, the hair on segment VI is always present; dorsal hairs lacking on all segments, two oval structures, could be bases of rudimentary hairs, are observable on the anterior part of the abdomen only. Segment VII on each side with an oval marginal sclerite with one hair, the sclerites sometimes fused with the dorsal pale brown, transverse elongate plate with spinulose imbrications and a pair of hairs, 59-88  $\mu$  long; the segments ventrally with 4-9 hairs, about 20-25  $\mu$  long. Tergite VIII a pale brown transverse elongate plate, e.g. 55  $\mu$  long, and 185  $\mu$  wide, with broadly rounded posterior margin, with spinulose imbrications, with two stout hairs on the raised median part,

56-84  $\mu$  long, and lateral to these usually one smaller hair. Siphunculi situated on segment VI, the lateral side pale brown, with some spinulose imbrications, and frequently fused with the marginal plate of segment VI; the pore pale brown, 30-33  $\mu$  wide, about on the same plane as the surroundings. Cauda (fig. 539) at the base 96-108  $\mu$  wide, with a knob 57-61  $\mu$  wide, 25-30  $\mu$  long and a rather indistinct constriction of 55-60  $\mu$ , with 10-12 hairs, the longest 43-55  $\mu$ . Subanal plate (fig. 539) bilobed, with 12-15 hairs, the longest 63-76  $\mu$ . Subgenital plate with 4-10 anterior hairs, 33-37  $\mu$  long, and 10-13 posterior hairs, 35-43  $\mu$  long. Gonapophyses two, each with 4-6 hairs, the longest 8-16  $\mu$ . Spiracles on 2-4 abdominal segments, II-V.

3. First stage larva of apterous viviparous female (fig. 547): Body length 370  $\mu$ , distance between outer margins of the eyes 130  $\mu$ , the head very pale brown, almost smooth, anterior to the eyes two pairs of hairs, between the eyes four hairs in a row, 75  $\mu$  long, and four  $\mu$  wide at the basal part. Antennae with four segments, 160  $\mu$  long, segment III with smooth imbrications, 70  $\mu$  long, without hairs; IV with imbrications with indistinct spinulae, 56  $\mu$  long, without hairs, but with four apical setae, 18  $\mu$  long. Stylets 270  $\mu$  long. Prothorax marginally on each side two hairs, and dorsally two hairs. Meso- and metathorax each with 2-3 marginal hairs on each side, 62-71  $\mu$  long, and two dorsal hairs, 76-84  $\mu$  long. Tibia of the fore leg 102  $\mu$  long, length of distal hairs 30  $\mu$  long, the hind tibiae distally with one spine, 12  $\mu$  long. All first tarsal segments with two hairs, 35-40  $\mu$  long. Two dorsoapical hairs of the second tarsal segment of the hind leg with expanded tips, 45  $\mu$  long, the tip two  $\mu$  wide. Abdominal segment I with a stout marginal hair, 86  $\mu$  long, and two dorsal hairs 88  $\mu$  long; II and III each only with a stout marginal hair, 84  $\mu$  and 71  $\mu$  long respectively, IV and V without hairs; VI only with a small marginal hair, 20  $\mu$  long; VII with a marginal hair, 26  $\mu$  long, and two stout dorsal hairs, about 80  $\mu$  long; VIII with two spinal hairs, about 50  $\mu$  long. Siphunculi on segment VI, the pore with a diameter of 14  $\mu$ . Cauda with two hairs, 16  $\mu$  long.

Embryos of alate viviparous females are of two types: Some alatae contain embryos with long stout hairs (fig. 548) similar to first stage larvae of apterous viviparous females, but some alatae contain embryos with short hairs, and it seems likely that these alatae migrate from *Litsea* to *Distylium*; a description of this embryo follows below.

4. Embryo with short hairs from alatae from *Litsea glutinosa* (fig. 549): Body length 450  $\mu$ . Antennae 165  $\mu$  long, with four segments; length of hair on segment I, 11  $\mu$ , longest hair on II, 30  $\mu$ ; segments III and IV with imbrications, without hairs, but IV with four apical setae, 14  $\mu$  long. Stylets about 170  $\mu$  long. Pro-, meso- and metathorax on each side each with two hairs, and one disc-shaped organ, with a diameter of 10-12  $\mu$ , and four  $\mu$  high, with a membrane without observable structure; the organs are similar to the button-organs described by Hille Ris Lambers and Takahashi (1959) in third and fourth stage alate larvae of *Reticulaphis distylii* (Van der Goot, 1917). Abdominal segments I-VII with one marginal hair, 12-25  $\mu$  long, and medial to the hair one button organ; dorsally only segment VII with two hairs, 18-20  $\mu$  long; VIII with two spinal hairs, 20  $\mu$  long. Siphunculi on segment VI, the pore with a diameter of 12  $\mu$ .

Host plant records. 1. From *Distylium stellare*: Prahoe (Dieng, 2550 m), 20.viii.1915, leg. P. van der Goot, in the collection at the Laboratorium voor Entomologie, Wageningen; Dieng, gall I, 26.viii.1957, x.1957, leg. Harjono, in the collection at the

British Museum (Natural History), London; Dieng (2050 m), 22.vii.1976, leg. D. Noordam, in the collection at the Rijksmuseum van Natuurlijke Historie, Leiden. 2. From *Litsea glutinosa* (Lour.) C.B. Robins. (syn. *L. chinensis* Lmk.): Bogor, 29.ix.1918, leg. P. van der Goot, in the collection at the Laboratorium voor Entomologie, Wageningen, and at the British Museum (Natural History), London; 13.xii.1931, leg. C.H.J. Franssen; Banjuwangi, 30.vi.1950, leg. F.W. Rappard, both in the collection at the British Museum (Natural History), London; Bogor, Kebun Raya, 12.ix.1976, leg. D. Noordam, in the collection at the Rijksmuseum van Natuurlijke Historie, Leiden. 3. *Lansium domesticum* Corr., Banjoewangi, 19.iv.1950, leg. F.W. Rappard, in the collection at the British Museum (Natural History), London.

The aphids, fundatrix with next generations and the fundatrigeniae live in leaf galls of *Distylium stellare*, described by Van der Goot (1917), and as gall no. 486 by Docters Van Leeuwen-Reijnvaan and Docters Van Leeuwen (1926); the galls 25-50 mm long, and 1.2-2.5 times as long as they are wide are fresh in July containing only apterae, and in August and October also alatae, while in December to April the empty woody galls are present; fresh galls are pale yellow or pale green with sometimes a dull peach-like red hue. Veins are observable on the innerside, and sometimes on the outside. The wall gradually becomes woody, up to five mm thick, but in the upper part a circular spot with a diameter of 9-15 mm with a wall about one mm thick remains, which opens as a window when alatae are present. The exules live on the lower side of the leaves of *Litsea*, along large and small veins; the larvae of the apterae move freely, but the adults are fixed to the leaf. It is assumed that alatae with *Litsea*-type embryos migrate to *Litsea*, and it is also assumed that alatae with embryos with short hairs and button-organs migrate to *Distylium*.

Etymology.— Gallarum, of galls, name applied to this species by Van der Goot (1917).

Discussion.— Hille Ris Lambers and Takahashi (1959) state that embryos inside alatae from *Distylium stellare* are exactly like embryos and first instar larvae of the *Litsea* aphid. But these two morphs as described in the present publication are quite different: the embryos from *Distylium* alatae all have marginal hairs on abdominal segments II-VII of about equal size, while in first instar larvae of *Litsea* some of these hairs on segments IV-VI are small or lacking. I think that the hair posterior to the siphunculi is located on segment VI, and does not correspond to the dorsal hair of segment VII in the *Litsea* aphid. The arrangement of the abdominal hairs in the *Distylium* embryos corresponds with those described for a second stage larva of *Nipponaphis ficicola*, but first stage larvae of *N. ficicola* apterae are not available. And so due to lack of a well established alternative the views of Hille Ris Lambers & Takahashi are held here.

**Schizoneuraphis litseicola spec. nov.**  
(figs. 550-553)

Types.— Holotype (apterous viviparous female) from *Litsea amara* Bl., Sindanglaya (1100 m), Java, Indonesia, no. 1290-1, 28.ii.1978, leg. D. Noordam. Paratype: one apterous viviparous female, and three larvae, the same data as the holotype. Holotype and paratype in the collection at the Rijksmuseum van Natuurlijke Historie, Leiden.

Apterous viviparous female.— In life: As apterae of *S. gallarum* from *Litsea*, no differences noticed.

Macerated specimens.— (figs. 550-552; described from two specimens). Body dark brown (the other specimen pale), obovate, 838-870  $\mu$  long, 1.4-1.7 times as long as it is wide, with three parts separated from each other by furrows or membranes: (1) head plus thorax plus abdominal tergite I (prosoma), an almost flat plate, the margins of which curve towards the ventral side and overlap the dorsal part of the sides of the thorax and abdominal tergite I; the prosoma with four pleural pairs of intermuscular plates transversely connected (except the foremost intermuscular plates) by furrows; the intermuscular plates and furrows are both marked by pustules, the rest of the prosoma is smooth. A fifth distal furrow, almost without pustules, surrounds the anterior and lateral sides of part (2), the tergites II-VII, a complex with the lateral and posterior margin thickened, and both provided with a crest; (3) segment VIII surrounded on all sides by thickened margins and a crest. (1) Is 3.5-3.7 times as long as (2), and 7.3-8.4 times as long as (3).

Prosoma.— The eyes and areas with stout hairs are almost at the same height, smooth, gradually sloping down to the three transverse furrows which are not membranous, but provided with oval pustules, 2-4  $\mu$  high with a diameter of 10-20  $\mu$ . Pleurally the furrows end in intermuscular plates which are surrounded by the same type of pustules; these plates and the pleural area between the plates are located 30-35  $\mu$  below the areas with stout hairs. The frons dorsal to the antennae with 4-5 hairs, 25-65  $\mu$  long, two anterior and four posterior stout interocular hairs, the longest 123-150  $\mu$ , and about six  $\mu$  wide near the base; between the interocular hairs about eight smaller hairs, about 50  $\mu$  long, and two  $\mu$  wide near the base. Eyes with three ommatidia, distance between the outer margins of the eyes 257-270  $\mu$ . Antennae (fig. 551) inserted about 70  $\mu$  below the eyes, 138-140  $\mu$  long, 0.16 times as long as the body, and 0.52-0.54 times the distance between the outer margins of the eyes, with three segments, but fused, and segment borders indistinct; base of segment I fused with the head, and with the same colour, 22-23  $\mu$  long; segment II paler, bent sideways, about 22-27  $\mu$  long, with a hair 12-18  $\mu$  long; segment III pale brown, 100  $\mu$  long, the distal rhinarium 7-8  $\mu$  from the tip, the penultimate rhinarium 36-37  $\mu$ ; III with three apical setae (larvae with four), 12-14  $\mu$  long, without other hairs. Ultimate rostral segment 78  $\mu$  long, 1.56 times as long as the second tarsal segment of the hind leg, the six distal primary hairs 10-20  $\mu$  long; length of the stylets 280  $\mu$  long. Prothorax on each side two stout hairs, and two stout dorsal hairs; next to these about 30 smaller hairs. Meso- and metathorax on each side each with two marginal stout hairs, and two dorsally, and small hairs about as on the prothorax.

Abdominal segment I with one marginal and two dorsal stout hairs, and small hairs about as on the prothorax. The stout hairs 130-180  $\mu$  long, and 7-10  $\mu$  wide near the base, the small hairs 30-80  $\mu$  long. Abdominal segments II-VII. Without pustules, smooth, but with some spinulose imbrications. The border between segments I-II is an almost flat, paler coloured band, 4-12  $\mu$  wide. The lateral and posterior margin thickened, and ventrally with a crest, 6-10  $\mu$  wide; the lateral sides dorsally on each side with a longitudinal row of six hairs, four of which stout hairs, 100-165  $\mu$  long, two corresponding to segments V and VI, 45-75  $\mu$  long; medial to these hairs, anterior to the siphunculi are two to six small hairs, about 50  $\mu$  long; segment VII with two submedian stout hairs, 100-135  $\mu$  long. Siphunculi on segment VI, a thickened ring,

23-25  $\mu$  wide, the pore with a diameter of about 10  $\mu$ . Abdominal segment VIII dorsally free, a brown plate, 2.1-2.6 times as wide as it is long, with the middle area about 25  $\mu$  raised to the lateral margins, with some irregular wrinkles, the posterior margin broadly rounded, a thickened ridge, 6-10  $\mu$  wide along the anterior and posterior margins with a crest along both sides, 10-15  $\mu$  wide. Submedian two stout hairs, 102-125  $\mu$  long, and six  $\mu$  wide at the base, and pleurally one hair, 55-61  $\mu$  long, and 2-3  $\mu$  wide at the base.

The sides ventral to the prosoma with a band of pustules, wax glands, with an irregular network structure; the brown sides, with laterally on each side about 50 hairs, 40-75  $\mu$  long, continue to the ventral side, a flat oval plate without hairs. Legs, coxae dark brown as the body, the other parts of the legs pale brown; fore legs inserted about 100  $\mu$  below the dorsum; tibia of the fore leg 108-110  $\mu$  long, 0.41-0.42 times as long as the distance between the outer margins of the eyes. First tarsal segments of fore- and midleg with three hairs, the lateral 0.6-0.8 times as long as the middle hair, of the hind leg with two hairs, 14-18  $\mu$  long; second tarsal segment of the hind leg 0.32-0.33 times as long as the tibia of the hind leg, and 0.18-0.19 times as long as the distance between the outer margins of the eyes, with two dorsoapical hairs, 35-41  $\mu$  long, with slightly expanded tips, 1-2  $\mu$  wide. Empodial hairs of the hind leg lacking or indistinct. Length of the hind segments: femur fused with trochanter 120-137  $\mu$ , tibia 150-155  $\mu$ , 1.13-1.25 times as long as the femur, and 0.55-0.60 times the distance between the outer margins of the eyes, first tarsal segment 22-23  $\mu$ , second tarsal segment 49-50  $\mu$ . Spiracles on each side, one between fore- and midlegs, and one between mid- and hind legs, abdominal spiracles are lacking. Cauda (fig. 552) colourless, at the base 68-74  $\mu$  wide, with a knob 46-53  $\mu$  wide and 22  $\mu$  long, the constriction with a diameter of 37-41  $\mu$ , with 7-8 hairs, the longest 47-57  $\mu$ . Subanal plate colourless, bilobed with 12 hairs, 49-61  $\mu$  long. Subgenital plate with two anterior hairs, 37  $\mu$  long, and 16 posterior hairs, 39  $\mu$  long. Gonapophyses two, each with 2-3 hairs, 6  $\mu$  long.

First stage larva of apterous viviparous female (fig. 553; description of one specimen): Body length 450  $\mu$ , length of head plus pronotum 147  $\mu$ , width of prothorax 161  $\mu$ , head across the eyes 137  $\mu$ ; frons of the head very pale brown with some indistinct pustules, anterior to the eyes three pairs of hairs, between the eyes four hairs in a row, 55  $\mu$  long. Antennae with three or indistinctly four segments, 183  $\mu$  long, segment III with almost smooth imbrications, segment III, 133  $\mu$  long, the distal rhinarium 14  $\mu$  from the tip, the other 56  $\mu$ , without hairs, but with four apical setae, 12-22  $\mu$  long. Stylets 285  $\mu$  long. Pro-, meso- and metathorax each with two stout hairs on each side, and with a pair of dorsal hairs, 50-70  $\mu$  long. Tibia of the fore leg 102  $\mu$  long, length of distal hairs 28  $\mu$  long, the hind tibiae distally with one spine, 10-12  $\mu$  long. All first tarsal segments with two hairs, about 40  $\mu$  long. Two dorsoapical hairs of the second tarsal segment of the hind leg 45  $\mu$  long, with expanded tips, 1-2  $\mu$  wide. Abdominal segments I-VII each with a marginal hair; length on I, 71  $\mu$ ; II, 65  $\mu$ ; III, 59  $\mu$ ; IV, 53  $\mu$ ; V seven  $\mu$ ; VI, 16  $\mu$ ; VII, 27  $\mu$ . A pair of dorsal hairs only on segment I, 67  $\mu$  long, and on VII, 43  $\mu$ . Segment VIII with two submedian hairs, 40  $\mu$  long. Siphunculi on segment VI, the pore with a diameter of 16  $\mu$ . Cauda with two hairs, 15  $\mu$  long.

Host plant record. *Litsea amara* Bl., Sindanglaya (1100 m), 28.ii.1978, leg. D. Noor-dam, in the collection at the Rijksmuseum van Natuurlijke Historie, Leiden.

The aphids were living on the lower side of a mature leaf.

Etymology.— *Litseicola*, dwelling on *Litsea*.

Discussion.— *S. litseicola* is included in the genus *Schizoneuraphis* on the basis of similarities of apterae to those of *S. gallarum* on *Litsea*; morphs from *Distylium*, however, are not known from *S. litseicola*.

***Schizoneuraphis longisetosa* spec. nov.**  
(figs. 554-565)

Types.— Holotype (apterous viviparous female from *Distylium stellare* O.K., gall no. 2, Dieng, Java, 26.viii.1957, leg. Harjono. Paratypes: 22 apterae plus numerous immature ones with the same data as the holotype, and 90 alatae plus numerous first instar progeny with the same data, but from 27.v.1958. Holotype and paratypes in the collection at the British Museum (Natural History), London.

Galls of *Distylium stellare* were collected by Harjono which he marked as no. 2, and which contained apterae and alatae. The apterae were distinguished from other *Distylium stellare* aphids by longer hairs and linear wax glands on the abdomen; inside the alatae were embryos characteristic of the Nipponaphidini, with groups of wax glands rather similar to those in embryos inside apterae of *Metanipponaphis vanderghooti*. The similarities between *S. longisetosa* and *Nipponaphis javanica* are even more striking: first stage larvae of alatae of *S. longisetosa* have similar plates with pustules and spinulae, and the same arrangement of hairs as first stage larvae of *N. javanica* apterae, but the number of pustules is less and the length of hairs shorter in *N. javanica*. So *S. longisetosa* is not transferred to any genus or species of migrants of the Nipponaphidini.

1. Apterous viviparous female of gall no. 2 of *Distylium stellare*.

Macerated specimens.— (fig. 554; described from seven specimens). Body length 1.12-1.54 mm, 1.3-1.6 times as long as it is wide, the middle anterior part of the head and the middle of tergite VIII very pale brown, the rest colourless.

Head.— Head dorsally smooth, the width across the eyes 255-362  $\mu$ , anteriorly with three pairs of hairs in the middle, and a transverse row of four hairs between the eyes, 157-196  $\mu$  long, 2-3  $\mu$  wide near the base, and the end thread-like. Antennae pale brown, with three segments, 203-244  $\mu$  long, 0.15-0.20 times as long as the body, 0.62-0.84 times the distance between the outer margins of the eyes; segments I and II almost smooth with a hair 37-49  $\mu$ , and 29-51  $\mu$  long respectively; III with almost smooth imbrications, but looking slightly notched, without hairs, but with four apical setae, 14-16  $\mu$  long; the processus terminalis 16-19  $\mu$  long, the penultimate rhinarium 55-59  $\mu$  from the tip. Eyes brown, with three ommatidia with a diameter of 12  $\mu$ . Ultimate rostral segment 76-82  $\mu$  long, 0.93-1.05 times as long as the second tarsal segment of the hind leg; stylets 255-290  $\mu$  long.

Thorax.— The pronotum fused with the head, on each side two marginal hairs, and 2-4 dorsal hairs, two of which larger, 140-186  $\mu$  long. Meso- and metathorax without segmental borders, each with two marginal hairs on each side, and each with 6-12 dorsal hairs, the longest 143-186  $\mu$ . Legs brown, the basal part of the tibiae slightly darker, all segments with a few imbrications with a few spinulae not more than one  $\mu$  long. Tibia of the fore leg 216-251  $\mu$  long, 0.15-0.18 times as long as the length of the

body, and 0.64-0.85 times the width of the head across the eyes. First tarsal segments of fore- and midleg with three hairs, of the fore leg the lateral hairs 10-14  $\mu$  long, the middle more sturdy, 14-16  $\mu$  long, the lateral hairs 0.67-1.08 times as long as the middle; of the hind leg with two hairs, 12-20  $\mu$  long. Second tarsal segments of the hind leg 0.24 times as long as the tibia of the hind leg, and 0.23-0.29 times as long as the width of the head across the eyes, with two dorsoapical hairs without expanded tips, 25-47  $\mu$  long. Empodial hairs of the hind leg 4-8  $\mu$  long. Length of the segments of the hind leg: femur plus trochanter 338-385  $\mu$ , tibia 310-358  $\mu$ , 0.88-0.94 times as long as the femur, and 0.96-1.17 times the width of the head across the eyes, first tarsal segment 35-39  $\mu$ , second tarsal segment 74-85  $\mu$ .

Abdomen.— Segments of the abdomen fused and an indistinct border only between segments VII and VIII. Margins of the body from just posterior to the siphunculi to posterior to the marginal hair of segment I with linear wax glands (fig. 555), observable at magnifications above 250, width of the lines about half a  $\mu$ ; the lines are sometimes also observable in an oval area on the middle of segments II-VI; the tergum of segments V-VIII with spinulose imbrications. One marginal hair on each side to what corresponds to segments I-VII, tergite I with 1-6 hairs, II and III with 1-5, IV with 2-4; V, 0-3; VI, 1-2; VII, 0-3; length of dorsal hairs 45-186  $\mu$ ; length of ventral hairs on segment IV, 45-67  $\mu$ . Tergite VIII with 6-8 hairs, 96-170  $\mu$  long. Siphunculi located dorsally on segment VI, colourless or very pale brown, the base oval with the longest diameter 33-50  $\mu$ , 1.2-1.6 longer than the shortest diameter, with some concentrically arranged wrinkles; the pore brown, diameter of the pore 23-29  $\mu$ , without a rim. Cauda transversely elongate, without a constriction, dorsally 127-178  $\mu$ , almost without a division with tergite VIII, more ventral at the base 108-125  $\mu$  wide, and 37-45  $\mu$  long, with 9-13 hairs, the longest 59-84  $\mu$ . Subanal plate with a median incision which is sometimes only slight, with 11-15 hairs, 61-92  $\mu$  long. Subgenital plate with conspicuous spinulose imbrications, with 2-4 anterior hairs, 51-78  $\mu$  long, and 11-13 posterior hairs, 57-78  $\mu$  long. Gonapophyses two, each with 3-6 hairs, 10-12  $\mu$  long.

## 2. Alate viviparous female (emigrant).

Macerated specimens.— (figs. 556-562; described from five specimens). Body length 2.42-2.82 mm, 2.0-2.4 times as long as it is wide.

Head.— (figs. 555, 556). Head black, with blunt spinulae of about one  $\mu$  diameter, especially medial to the paired ocelli arranged in lines or somewhat as a network; width across the eyes 433-496  $\mu$ , dorsal to the median ocellus three pairs of hairs, and posterior to the paired ocelli four hairs, 43-69  $\mu$  long. Ventrally posterior to the median ocellus altogether 1-5 hairs. Antennae brown, with yellowish brown rings, with five segments, 853-920  $\mu$  long, 0.32-0.36 times as long as the body, and 1.8-2.0 times the width of the head across the eyes; segment I somewhat wrinkled; segment II with wrinkles and especially on the ventral side arranged as a network, with some spinulae; segments III-V (fig. 557) with ring-shaped secondary rhinaria, the rings are not closed on the dorsal side, most rings with a narrow space of 2-10  $\mu$ , but at the base of segment III up to 40  $\mu$ ; between the rhinaria are 3-5 concentric spinulose imbrications, dorsally and ventrally with interconnections; the rhinaria are two  $\mu$  wide. The primary rhinarium on segments IV and V is located distally to the secondary rhinaria, is annular, bifurcated and wider than the secondary rhinaria; segment III with 25-31 annular rhinaria, IV with 12-16, V with 8-13; hairs on segments III-V lacking, but on segment V four apical setae, 12-16  $\mu$  long. Length of segment III, 397-433  $\mu$ , 1.9-



2.0 times as long as IV, 2.6-2.8 times as long as V, and 1.1-1.2 times as long as IV plus V; segment IV, 208-224  $\mu$  long, 1.3-1.5 times as long as V; segment V, 141-159  $\mu$  long, the processus terminalis 10-16  $\mu$ , only half as wide as the basal part of segment V. The last rostral segment 96-98  $\mu$  long, 0.61-0.67 times as long as the second tarsal segment of the hind leg, without accessory hairs; length of the stylets 290  $\mu$ . Eyes black, the ocular tubercle extending sideways about 25  $\mu$ .

Thorax.— Sides of the prothorax blackish, mesothorax black. Fore wing (fig. 558) pale brown, the leading edge, the pterostigma, the basal area and borders of the anal vein darker, and an oval area bordered by the bases of cubitus, medial vein, radial sector and by the subcosta almost colourless; the medial vein once branched, median I is long, 1.8-2.3 times as long as the distance from the base of the fork to the base of the anal vein; anal vein and cubitus I united at the subcosta; the hind wing with two oblique veins. Legs brown, the dorsal side of the femora and the basal half of tibiae black; femora, tibiae and second tarsal segments densely with spinulose imbrications, the spinulae 1-3  $\mu$  long; the tibia of the fore leg 574-630  $\mu$  long, 1.2-1.3 times as long as the width of the head across the eyes, length of the hairs of the hind tibia 65-88  $\mu$ ; chaetotaxy of first tarsal segments 3, 3, 2, the lateral hairs of the fore leg (fig. 559) 2.9-3.8 times as long as the middle hair; length of the hairs of the first tarsal segment of the hind leg 61-69  $\mu$ ; the four apical hairs of the second tarsal segment of the hind leg (fig. 560) with expanded tips, the dorsal hairs 67-74  $\mu$  long, the tips 5-6  $\mu$  wide; empodial hair of the hind leg with an expanded tip, 30-39  $\mu$  long. Length of the hind segments: femur fused with the trochanter 574-626  $\mu$ , tibia 779-851  $\mu$ , 1.34-1.37 times as long as the femur, and 1.6-1.8 times the width of the head across the eyes; first tarsal segment 49-53  $\mu$ , second tarsal segment 147-157  $\mu$ .

Abdomen.— (fig. 561). Abdominal segments I-V colourless, VI with a marginal sclerotic plate very pale brown with one hair and indistinct radially arranged spinulose imbrications, with a diameter of about 20  $\mu$ ; VII with a marginal and one dorsal pale brown sclerotic plate with a diameter of about 70  $\mu$ , each with one hair and radially arranged spinulose imbrications; on each segment one marginal hair 65-96  $\mu$  long. Tergite VIII e.g. 88  $\mu$  long and 330  $\mu$  wide, with spinulose imbrications, the part with hairs pale brown and with more distinct spinulose imbrications, between the two middle hairs sometimes a transverse ridge, 11-13  $\mu$  wide, 88-108  $\mu$  long. Siphunculi on segment VI, brown with concentric wrinkles, diameter at the base 57-65  $\mu$ ; the pore black, with a diameter of 33-40  $\mu$ , about 15  $\mu$  above the base. Cauda (fig. 562) transversely elongate without a constriction, 137-159  $\mu$  wide, 41-51  $\mu$  long, with 10-12 hairs, 72-80  $\mu$  long. Subanal plate bilobed, with 14-19 hairs, 67-82  $\mu$  long. Subgenital plate with 13-17 anterior hairs, 78-92  $\mu$  long, and 10-13 posterior hairs, 78-92  $\mu$  long. Gonapophyses two, each with 8-10 hairs, 25-33  $\mu$  long. Spiracles on four abdominal segments, II-V, and sometimes a rudimentary spiracle on segment I.

3. First stage larva of apterous viviparous female (fig. 563; description of one specimen): Body colourless, length 622  $\mu$ , length of head plus pronotum 192  $\mu$ , width of prothorax 410  $\mu$ , distance between the outer margins of the eyes 224  $\mu$ . The frons dorsally with two pairs of hairs, 106  $\mu$  long, between the eyes four hairs, 108  $\mu$  long. Antennae with four segments, 176  $\mu$  long; segment II smooth, with a hair 33  $\mu$  long; segment III, 74  $\mu$  long, with some almost smooth imbrications, without hairs; IV, 51  $\mu$  long with imbrications with fine spinulae, without hairs, but with four apical setae, 18-22  $\mu$  long, the processus terminalis 14  $\mu$ , the penultimate rhinarium 51  $\mu$  from the tip. The legs very pale brown, with some rather indistinct spinulose imbrications on

all segments; tibia of the fore leg 116  $\mu$  long, 0.52 times as long as the distance between the outer margins of the eyes; length of distal hairs of the hind tibia 23  $\mu$ . All first tarsal segments with two hairs, of the hind leg 25  $\mu$  long. Two dorsoapical hairs of the second tarsal segment 57  $\mu$  long, the tips expanded, two  $\mu$  wide. Dorsal thoracic hairs 88-121  $\mu$  long, hair on tergite VIII, 74  $\mu$  long; dorsal hairs on abdominal segments II-VII are lacking. Cauda with two hairs, 33  $\mu$  long. Siphunculi present, the pore 14  $\mu$  wide.

4. Embryos inside alatae show the alatae to be migrants; a description is given of first stage larvae born from these alatae:

First stage larva (figs. 564, 565; description of one specimen). Body length 578  $\mu$ , length of head plus pronotum 236  $\mu$ , width of the prothorax 275  $\mu$ , head across the eyes 188  $\mu$ ; the head pale brown, the anterior part darker, medial to the eyes on each side a group of 4-7 pustules; the pustules with a diameter of 10-12  $\mu$ , roundish or elliptical or somewhat angular with a wall 1-2  $\mu$  thick, the central part almost flat and brighter than the surroundings; the pustules are located on a plate provided with blunt spinulae, 1-2  $\mu$  wide; anterior to the eyes two pairs of hairs, 143  $\mu$  long, between the eyes four hairs 172  $\mu$  long. Antennae with four segments, 220  $\mu$  long, segment III with almost smooth imbrications, 96  $\mu$  long; IV, 72  $\mu$  long, the processus terminalis 18  $\mu$  long, the penultimate rhinarium 77  $\mu$  from the tip; length of hair on segment I, 70  $\mu$ , on II, 45  $\mu$ , lacking on III and IV, the four apical setae 20  $\mu$  long. Stylets 510  $\mu$  long. Prothorax marginally on each side two hairs, and a group of 3-5 pustules on a plate with spinulae, dorsally a pair of hairs along the posterior margin, 220  $\mu$  long, and an anterior pair of 2-6 pustules, and a posterior pair of 3-5 pustules, all on a plate with spinulae. Mesothorax a marginal group of 2-6 pustules on a plate with spinulae, between the two marginal hairs, 194  $\mu$  long; dorsally one pair of hairs, 210  $\mu$  long and lateral to these a plate with 4-8 pustules. Metathorax marginally a plate with 2-4 pustules and dorsally a pair of plates with 1-3 pustules. Tibia of the fore leg 110  $\mu$  long, length of distal hair of the hind tibia 53  $\mu$  long, and distally with two spines, 10  $\mu$  long. All first tarsal segments with two hairs, of the hind leg 46  $\mu$  long. Two dorsoapical hairs of the second tarsal segment of the hind leg 55  $\mu$  long, the tips expanded, four  $\mu$  wide. Abdominal segments I and II each marginally with 1-4 pustules and dorsally a pair of plates, lateral to a dorsal hair on segment I, the hair 188-210  $\mu$  long, the plates each with 1-3 pustules; hairs are lacking on tergite II; all plates with spinulae.

Abdominal segments III-VII (fig. 565) marginally each with one pustule and with spinulae, dorsally hairs are lacking, and a pair of plates each with usually one pustule on segments III and IV, and sometimes V. Tergite VIII without pustules, with two hairs, 150  $\mu$  long. Siphunculi on segment VI, the pore with a diameter of 22  $\mu$ . Spiracles on the abdomen not observable.

Host plant records.— Specimens were collected in Java: *Distylium stellare* O.K., gall no. 2, Dieng, 26.viii.1957, 27.v.1958, leg. Harjono, in the collection at the British Museum (Natural History), London.

Alatae were collected 27.v.1958.

The aphids, apterae and alatae collected, live inside galls indicated on the labels as no. 2. On the basis of a note on page 16 of Hille Ris Lambers and Takahashi (1959) I am assuming that this gall is semiglobular above the leaf and that it turns red when ripe.

Etymology.— Longisetosa, with long hairs, the name which Dr D. Hille Ris Lambers intended to give to this species.

Genus *Sinonipponaphis* Tao, 1966  
(fig. 566)

*Sinonipponaphis* Tao, 1966: 175 (type species *Astegopteryx formosana* Takahashi, 1927).

Description.— Apterous viviparous female.— (one species). In life: Body dull black or brownish black. Eyes and antennae black, legs whitish. Without wax.

Macerated specimens.— Body brown, a box with flat, oval dorsum, with two parts: (1) the fused head, thorax and abdominal tergites I-VII; (2) the free tergite VIII, along the posterior margin with a crest. The sides of the dorsum of head, thorax, abdominal tergites I-VII, together with tergite VIII enclosed by the strongly sclerotic sides, separated from these by a colourless line; the head to tergite VII, 7.0-7.6 times as long as tergite VIII. Length of the body 760-1010  $\mu$ , 1.1-1.2 times as long as it is wide. The head without horns or dagger hairs, and as other parts of the body without wax gland groups. The head, and all parts of the body up to tergite II densely covered with hair-like curved processes, 15-40  $\mu$  long, with a base with a diameter of 3-6  $\mu$ . On the dorsal plate four pairs of intersegmental muscular plates which mark the non-observable borders between the anterior segments of the body, the three distal pairs with darker brown ovals, 10-15  $\mu$  wide. Two hairs on each side of the dorsum mark the pro-, meso-, and metanotum, and each of these segments dorsally bears two hairs, 82-127  $\mu$  long, and 6-7  $\mu$  wide near the base, on each side on abdominal segments II and III, two stout hairs, and on VI-VII two small hairs, on what are assumed to be segments IV and V hairs are lacking; dorsal hairs, and hair-like processes are lacking on segments II-VII; siphunculi presumably on segment VI the pore about 25  $\mu$  wide. Tergite VIII with two stout hairs, 120  $\mu$  long, and lateral to these a small hair, 55-70  $\mu$  long. Eyes with three ommatidia. Antennae with three fused segments, 29-40  $\mu$  long, 0.03-0.04 times as long as the body, and 0.09-0.14 times the distance between the outer margins of the eyes; segment III sometimes with two rhinaria. Length of the ultimate rostral segment 55  $\mu$ . Spiracles on each side one between fore- and midleg, and one between mid- and hind leg. The legs colourless, the tibia of the fore leg about 88  $\mu$  long, 0.29 times as long as the distance between the outer margins of the eyes. Cauda with a knob and a constriction, transversely elongate 55-61  $\mu$  wide, and 20-23  $\mu$  long, with 8-11 hairs, the longest 40-55  $\mu$ . Subanal plate bilobed, with 10-15 hairs, 60-69  $\mu$  long. Subgenital plate with two anterior, and 10-13 posterior hairs. Gonapophyses presumably two, with 2-4 hairs. The venter a flat plate, in size and shape almost equal to the dorsum.

Etymology.— *Sinonipponaphis*, Chinese *Nipponaphis*, name given to this genus by Tao (1966).

*Sinonipponaphis hispida* spec. nov.  
(fig. 566)

Types.— Holotype (apterous viviparous female) from *Lithocarpus indutus* (Bl.)

Rehd. (djalaprang), Tjisoeroepan-Garoet (1400 m), no. 302-8, 22.viii.1916, leg. P. v. d. Goot. Paratypes: 11 apterous viviparous females, same data as the holotype, no. 302-1-7. Holotype and paratypes in the collection at the Laboratorium voor Entomologie, Wageningen.

Van der Goot collected this aphid, and described (unpublished manuscript) the apterous viviparous female. Data from this manuscript are included in the following description.

**Apterous viviparous female.**— In life: Body dull black or brownish black, without wax. Eyes and antennae dark. Legs whitish. Siphunculi black, cauda reddish brown.

**Macerated specimens.**— (fig. 566; described from 12 specimens). Body brown, with flat oval dorsum, 760-1010  $\mu$  long, 1.1-1.2 times as long as it is wide; a box with vertical black margins, encircling and enclosing on the posterior side the cauda, anal plate and subgenital plate. Head, thorax and abdominal segments I-VII dorsally fused, without any transverse furrow, 7.0-7.6 times as long as the length of abdominal segment VIII. Abdominal segment VIII free.

The head dorsal to the eyes rises 40-75  $\mu$ , bending sharply towards the flat dorsal side, densely covered with hair-like curved processes, 15-40  $\mu$  long, with a base with a diameter of 3-6  $\mu$ . The frons ventral to the antennae with a pair of hairs, 35-40  $\mu$  long, and dorsal to the antennae two pairs of hairs, 33-49  $\mu$ , and 60-90  $\mu$  long respectively; a row of four stout interocular hairs, 107-121  $\mu$  long on a process about 20-25  $\mu$  wide and 10  $\mu$  high. Eyes located on the bent part of the frons with three ommatidia with a diameter of 12  $\mu$ , protruding 15  $\mu$ , distance between the outer margins 267-330  $\mu$ . Antennae inserted 100-120  $\mu$  ventral to the dorsum, 29-40  $\mu$  long, 0.03-0.04 times as long as the body, and 0.09-0.14 times the distance between the outer margins of the eyes; the segments are fused together, and segment I basally with the head; segment I black, about 20  $\mu$  long with a hair, 12-20  $\mu$  long; segment II, brown, about 15  $\mu$  long; segment III colourless or brown, 12-19  $\mu$  long, sometimes with two primary rhinaria, without hairs or apical setae. Ultimate rostral segment measurable in one specimen only, 55  $\mu$  long, length of stylets not measurable. On the dorsal plate four pairs of intersegmental muscular plates, the pair on the pronotum rather indistinct, with darker brown ovals; a transverse paler brown line observable between each of the pairs of muscular plates. The whole dorsum, thorax and the part that corresponds to abdominal segment I, with numerous hair-like processes as on the head, which are lacking on the intersegmental muscular plates. Margin of the dorsal plate of pro-, meso- and metathorax each with two hairs on each side, 92-127  $\mu$  long, and each dorsally with two hairs, 82-126  $\mu$  long, and 6-7  $\mu$  wide near the base. Abdominal segment I marked by one marginal hair on each side, dorsally hairs are lacking or one hair is present.

No border between abdominal segments I and II, the hair-like processes continue up to the marginal hair, 127  $\mu$  long, which presumably corresponds to segment II, the rest of segments II-VII are smooth with only rather indistinct spinulose imbrications. Medial to this hair on each side a hair considered to be located on segment III, 118  $\mu$  long. Marginal hairs of what is considered as segments IV and V are lacking; marginal hairs of VI, 0-23  $\mu$  long, of VII, 14-44  $\mu$ . The posterior margin of segment VII is straight, but the posterolateral side protrudes 15-40  $\mu$ , with a rounded point. Dorsal hairs are lacking on segments II-VII. Siphunculi presumably on segment VI,

with a thickened darker brown pore, 25-30  $\mu$  wide, and 18-25  $\mu$  long. Abdominal segment VIII free, dark brown, e.g. 196  $\mu$  wide, and 110  $\mu$  long, with a straight anterior margin, and posteriorly rounded, with a thickened margin, and a smooth crest, 6-8  $\mu$  wide; the plate with some spinulose imbrications, with two submedian stout hairs, 120  $\mu$  long, and lateral to these a small hair, 55-70  $\mu$  long. The vertical black margins densely covered with hair-like processes, and a few hairs. Legs with black coxae, the rest of the legs almost colourless, the tibia of the fore leg about 88  $\mu$  long, 0.29 times as long as the distance between the outer margins of the eyes. On each side two spiracles, one between the fore- and midleg, the other between mid- and hind leg. Cauda at the base 71-82  $\mu$  wide, the knob 55-61  $\mu$  wide, and 20-23  $\mu$  long, the constriction 43-47  $\mu$  wide, with 8-11 hairs, the longest 40-55  $\mu$ . Subanal plate bilobed, with 10-15 hairs, 60-69  $\mu$  long. Subgenital plate with two anterior hairs 20-35  $\mu$  long, and 10-13 posterior hairs, 31-51  $\mu$  long. Gonapophyses presumably two, with 2-4 hairs but obscured by covering parts. The venter is an elliptical flat plate, almost the same in size and shape to the dorsum, but without the posterior bend outwards, 755-944  $\mu$  long, 1.1-1.2 times as long as it is wide; the plate is almost colourless, smooth, without hairs, with a crest 8-45  $\mu$  wide all around.

Host plant records.— Specimens were collected in Java: *Lithocarpus indutus* (Bl.) Rehd. (djalaprang), Tjisoeroepan (400 m), 26.viii.1916, leg. P. v.d. Goot, in the collection at the Laboratorium voor Entomologie, Wageningen; *Lithocarpus indutus*, Pasirwangi (1000 m) 16.viii.1916, leg. P. v.d. Goot, in the collection at the British Museum (Natural History), London.

The aphids were living more or less scattered on the underside of the leaves.

Etymology.— *Hispida*, covered with stiff hairs.

### Genus *Thoracaphis* Van der Goot, 1917

(figs. 567 - 579)

*Thoracaphis* Van der Goot, 1917: 242 (Type species *Thoracaphis arboris* Van der Goot, 1917).

Description (one species).— Apterous viviparous female.— In life: Bluish black, sides of the body with wax hoar frost. Larvae greenish yellow with powdery wax along the margin of the body and two longitudinal rows of patches of wax dorsally.

Macerated specimens.— Body a very flat broadly elliptical brown disc with three parts: (1) the prosoma, the head plus thorax and abdominal tergite I, completely separated on the lateral sides from abdominal tergite II, but in the middle fused with tergite II, the whole edge of the prosoma with radial stripes, 20-70  $\mu$  long; the meso- and metanotum in the middle with ridges arranged in two longitudinal lines, 150-220  $\mu$  apart, the area in between usually sunk 10-40  $\mu$ ; (2) the complex of tergites II-VII; (3) tergite VIII free, without a crest. The prosoma is 3.0-3.9 times as long as complex II-VII, and 8.3-12.1 times as long as tergite VIII. Length of the body 1.3-1.6 mm, 1.1-1.5 times as long as it is wide. The head without horns or dagger hairs, and as other parts of the body without wax gland groups; posterior to the eyes usually on each side 12 marginal hairs, 141-208  $\mu$  long. Eyes with three ommatidia, dorsally close to the striped band. Between the eyes a row of four hairs, and anterior to these 5-7 hairs. The surface of the prosoma is flat and smooth. The prothorax dorsally with

4-7 hairs, the mesonotum with 10-14, the metanotum 9-13, and abdominal tergite I, 7-8.

Antennae ventrally, with three segments, 80-110  $\mu$  long, 0.06-0.08 times as long as the body, and 0.23-0.31 times the distance between the outer margins of the eyes; the distal rhinarium located 8-10  $\mu$  from the tip, the penultimate rhinarium 29-45  $\mu$ . Eyes with three ommatidia. Ultimate rostral segment 55-65  $\mu$  long, 1.10-1.18 times as long as the second tarsal segment of the hind leg, without accessory hairs; length of the stylets 725-780  $\mu$  long. Spiracles on each side two, one between fore- and midleg, and one between mid- and hind leg. The legs colourless, smooth, inserted ventrally, at most the tibiae partly extending outside the prosoma, the tibia of the fore leg 137-163  $\mu$  long, 0.37-0.43 times as long as the distance between the outer margins of the eyes; first tarsal segments of fore- and midleg with three hairs, the middle hair more sturdy than the lateral, the lateral 0.62-0.78 times as long as the middle; first tarsal segment of the hind leg with two hairs, 16-19  $\mu$  long. The complex of segments II-VII brown, a plate with the posterior side slightly concave, with the sides protruding backwards about 50  $\mu$ . On each side six hairs corresponding to each of the six segments, the anterior 60-108  $\mu$  long, the posterior 40-57  $\mu$ ; medial and pleural hairs on each side of the middle 6-10. The siphunculi on segment VI, a thickened ring with a diameter of 31-40  $\mu$ . Tergite VIII brown or black, 225-260  $\mu$  wide, 92-104  $\mu$  long, with four hairs, 47-52  $\mu$  long. Cauda with a base 94-110  $\mu$  wide and about 25  $\mu$  long, and a knob e.g. 53  $\mu$  wide and 51  $\mu$  long with a slight constriction, with 10-11 hairs, the longest 61-84  $\mu$ . Subanal plate bilobed, with 10-12 hairs, the longest 84-116  $\mu$ . Subgenital plate with two anterior hairs, 20-27  $\mu$  long, and 12-17  $\mu$  posterior hairs, 51-58  $\mu$  long. Gonapophyses two, each with 2-3 hairs, 16-23  $\mu$  long.

First stage larvae of aptera not available, but last stage larvae with roundish wax glands, 2-4  $\mu$  diameter, which are densely arranged as a band along the margin of the head, thorax and abdomen but with intervals around the eyes, and at the posterior margin of pro-, meso-, metathorax, abdominal segment I, and abdominal segment VII; roundish areas of the same type of wax glands are located pleurally on the tergites of thorax and abdomen.

Alate viviparous female.— (one species). In life black, the abdomen dull greenish. Pterostigma of the fore wing greyish black. Larvae dull greenish, the abdomen thickly covered with white waxy flocculence, forming on the caudal region a few long, more or less erect waxy bundles. Macerated specimens: Body length 2.5-3.0 mm. The head smooth, without horns or dagger hairs, anterior to the paired ocelli three pairs of hairs, posterior a row of four hairs, 35  $\mu$  long. Antennae with five segments, 732-880  $\mu$  long, 0.29 times as long as the body, and 1.2 times the width of the head across the eyes. Antennal segments III-V with ring-shaped secondary rhinaria; the primary rhinaria are moulded with the secondary rhinaria to a complex structure, wider than the other annular rhinaria; segment III with 17-25 annular rhinaria, IV with 7-9, V with eight. Length of antennal segment III, 358  $\mu$ , 2.7 times as long as IV, 2.4 times as long as V, and 1.26 times as long as IV plus V; segment IV, 134  $\mu$  long, 0.90 times as long as V; segment V, 149  $\mu$  long, the processus terminalis 2-14  $\mu$ . The last rostral segment 98  $\mu$  long, 0.83 times as long as the second tarsal segment of the hind leg, without accessory hairs; length of the stylets 435  $\mu$ . Eyes compound. Fore wing medial vein once branched, anal vein and cubitus usually not united at the base; the hind wing with two oblique veins. The femora almost smooth, the tibiae and second tarsal segments densely with spinulose imbrications; the tibia of the fore

leg 748  $\mu$  long, 1.26 times as long as the width of the head across the eyes; first tarsal segments of fore- and midleg with three hairs, of the hind leg with two, the lateral hairs 2.6 times as long as the middle hair. Second tarsal segment of the hind leg 118  $\mu$  long, with four apical hairs with expanded tips. Abdominal segments I-VII colourless, each segment on each side with one marginal hair, 86-152  $\mu$  long, the tergites I-V each with 7-9 hairs, dorsally on segment IV, 186  $\mu$  long, ventrally 55  $\mu$ . Tergite VI with one hair, tergite VII with two. Tergite VIII with two spinal hairs, 140  $\mu$  long, and on each side one lateral hair. Siphunculi situated on segment VI, a brown ring with a diameter of 41  $\mu$ . Cauda at the base 176  $\mu$  wide and 108  $\mu$  long, cone-shaped with an almost straight posterior margin, 25  $\mu$  wide, with 12 hairs, the longest 41  $\mu$ . Subanal plate bilobed, with 15 hairs, the longest 73  $\mu$ . Subgenital plate with 14 anterior, and 18 posterior hairs. Gonapophyses two, each with six hairs, 30  $\mu$  long.

Last stage larvae of alate viviparous females have no roundish wax glands on the head, but a broad marginal band of roundish wax glands is present, with a diameter of 2-4  $\mu$ . Next to these wax glands on tergites V-VIII are areas with pores, about 0.5  $\mu$  wide.

Etymology.— *Thoracaphis*, *Aphis* with thorax, name pointing to the large head plus thorax which cover at least or about three fourths of the body (Van der Goot, 1917: 164, 243).

***Thoracaphis arboris* Van der Goot, 1917**  
(figs. 567-579)

*Thoracaphis arboris* Van der Goot, 1917: 243.

Types.— Lectotype (apterous viviparous female, here designated) from "wra-kas", Dieng, 4.iv.1916, leg. P. v.d. Goot, Det. P. v.d. Goot: *Thoracaphis arboris*. Paralectotypes 26 apterous viviparous females, one alate viviparous female and larvae, dates 4.iv.1916, 30.viii. 1916, other data as the lectotype. Lectotype and paralectotypes in the collection at the British Museum (Natural History), London.

This species is only known from specimens collected by Van der Goot, described by Van der Goot in 1917, and in his unpublished report. Data of these descriptions are added to the following description.

Apterous viviparous female.— In life: Body bluish black. The margins of the prosoma with a wide transversely striped band, which is lacking on the complex of abdominal segments II-VII. Eyes black. Antennae and legs pale brown. Siphunculi with a black border. Cauda black. Only the sides of the body along a rather short distance with a distinct wax hoar frost. Larvae dull greyish green, with a powdery wax flocculence along the margin of the body, and dorsally two longitudinal rows of patches of wax.

Macerated specimens.— (figs. 567-571; described from eight specimens). Body brown, a very flat broadly elliptical disc, 1.34-1.57 mm long, 1.1-1.5 times as long as it is wide, with three parts: (1) prosoma, head plus thorax plus abdominal tergite I, completely separated on the lateral sides from abdominal tergite II, but in the middle fused with tergite II, the margins a projection extending backwards up to half the length of the complex II-VII, the whole outer edge of the prosoma with radial stripes, the meso- and metanotum in the middle with two longitudinally arranged ridges,

and the area in between usually sunk 10-40  $\mu$ ; (2) the complex of tergites II-VII, and (3) tergite VIII, dorsally free from tergite VII, but pleurally with a distinct ventral sclerotic connection; (1) is 3.0-3.9 times as long as (2), and 8.3-12.1 times as long as (3); the sides and the venter colourless, completely located under the dorsum, the cauda and the subanal plate sometimes protruding at the posterior margin of tergite VIII.

**Prosoma.**— The whole margin of the prosoma with a radially striped band, not mentioned by Van der Goot (1917), but stated by Van der Goot in his unpublished notes; the band 20-70  $\mu$  wide, and provided with pustules (fig. 570) about two  $\mu$  wide, the stripes 3-6  $\mu$  wide; medial to the band, posterior to the eyes, usually on each side 12 marginal hairs, 141-208  $\mu$  long, the ends thread-like. Eyes with three ommatidia, dorsally close to the striped band, distance between the outer margins of the eyes 346-378  $\mu$ . Between the eyes a row of four hairs, and anterior to these 5-7 hairs, of which some of the middle ones are shorter than the others. The surface of the prosoma is flat and smooth, the muscular plates also, which are mainly observable as radially arranged internal ridges; the paired muscular plates in the middle between the thoracic segments and abdominal segments I and II are larger and show some facets while longitudinally arranged ridges constitute the wall of the sunken area which is usually present in the middle. The head ventrally between the antennae with 2-4 hairs, 18-29  $\mu$  long. The prothorax with on each side two marginal hairs, and 4-7 dorsal hairs; mesothorax with on each side three or rarely four hairs, and 10-14 dorsal hairs; metathorax on each side three or rarely four hairs, and 9-13 dorsal hairs; abdominal segment I with two or rarely three marginal hairs on each side, and 7-8 dorsal hairs; the dorsal hairs 100-150  $\mu$  long. Antennae (fig. 568) ventral, the distance between the bases of the segments I about 105  $\mu$ ; with three segments, 80-110  $\mu$  long, 0.06-0.08 times as long as the body, and 0.23-0.31 times as long as the distance between the outer margins of the eyes; the segments not fused together, and segment I basally not with the head; segment I, 22-27  $\mu$  long, with a hair 8-12  $\mu$  long; segment II, 15-22  $\mu$  long with a hair 8-18  $\mu$  long; segment III, 47-69  $\mu$  long, without hairs, but with four apical setae, 12-14  $\mu$  long, the processus terminalis 8-10  $\mu$  long, the distance from the penultimate rhinarium to the tip, 29-45  $\mu$ . Ultimate rostral segment (fig. 569) 55-65  $\mu$  long, 1.10-1.18 times as long as the second tarsal segment of the hind leg; stylets 725-780  $\mu$  long. Legs inserted ventrally, colourless, smooth, at most the tibiae partly extending outside the prosoma; tibia of the fore leg 137-163  $\mu$  long, 0.37-0.43 times as long as the distance between the outer margins of the eyes. First tarsal segments of fore- and midleg with three hairs, of the hind leg with two; of the fore tarsus 12-14  $\mu$  long, the middle more sturdy, 16-19  $\mu$  long, the lateral hairs 0.62-0.78 times as long as the middle; length of hairs of the hind tarsus 16-19  $\mu$ . Second tarsal segment of the hind leg 0.24-0.29 times as long as the tibia of the hind leg, and 0.13-0.16 times as long as the distance between the outer margins of the eyes, with two dorsoapical hairs without expanded tips 22-31  $\mu$  long; empodial hair lacking. Length of the hind segments: femur fused with trochanter, 204-224  $\mu$ , tibia 187-210  $\mu$ , 0.89-0.97 times as long as the femur, and 0.50-0.57 times the distance between the outer margins of the eyes, first tarsal segment 29-31  $\mu$ , second tarsal segment 50-59  $\mu$ . Spiracles ventral, one between fore- and midleg, the other between mid- and hind leg. The thorax ventrally colourless, with some hairs, about 20  $\mu$  long.

The complex of abdominal segments II-VII brown with darker brown lateral



sides, a plate e.g. 622  $\mu$  wide and 291  $\mu$  long, the posterior side slightly concave and the sides protruding backwards about 50  $\mu$ ; in the middle about six internal transverse darker brown bands; the surface almost smooth. On each side, 40-50  $\mu$  from the margin six hairs corresponding to each of the six segments, the anterior 60-108  $\mu$  long, the posterior 40-57  $\mu$ ; medial and pleural hairs on each side of the middle 6-10, occurring on each of the six segments, 50-148  $\mu$  long. The siphunculi on segment VI, a thickened ring with a diameter of 31-40  $\mu$ , the colourless pore about 20  $\mu$  wide. Abdominal segment VIII dorsally free, brown or black, transversely elongate, elliptical to slightly rectangular, pleural with a ventral brown or black connection with segment VIII, 225-260  $\mu$  wide, 92-104  $\mu$  long, smooth, with four hairs, 47-72  $\mu$  long. Cauda (fig. 571) colourless, the base 94-110  $\mu$  wide and about 25  $\mu$  long, with a knob and a slight constriction, e.g. the knob 53  $\mu$  wide, 51  $\mu$  long, with a diameter of the constriction 43  $\mu$ ; the knob 47-61  $\mu$  wide, with 10-11 hairs, the longest 61-84  $\mu$ . Subanal plate colourless with two roundish lobes, all together with 10-12 hairs, the longest 84-116  $\mu$ . Subgenital plate with two anterior hairs, 20-27  $\mu$  long, and 12-17 posterior hairs, 51-58  $\mu$  long. Gonapophyses two, each with 2-3 hairs, 16-23  $\mu$  long. The abdomen ventrally with 4-5 rows of 2-4 hairs, 12-20  $\mu$  long; spiracles are lacking on the abdomen.

Alate viviparous female.— In life: Head and thorax black, abdomen dull greenish. Eyes, antennae and legs black. Siphunculi with dark rims. Cauda blackish. Pterostigma of the fore wing greyish black. Larvae dull greenish. Abdomen thickly covered with long white waxy flocculence, which is especially abundant on the caudal region, forming there a few long, more or less erect waxy bundles.

Macerated specimens.— (figs. 572-576; described from one specimen). Body length 2.52 mm (Van der Goot, unpublished, 2.98 mm), 2.7 times as long as it is wide.

Head.— (fig. 572). Head brown, smooth; width across the eyes 594  $\mu$ , anterior to the paired ocelli three pairs of hairs, posterior a row of four hairs, 35  $\mu$  long, 0.06 times as long as the width of the head across the eyes. Ventrally posterior to the median ocellus on each side six hairs, 25  $\mu$  long. Antennae (fig. 573) brown, with black rings, with five segments, 732  $\mu$  (Van der Goot, unpublished, 880  $\mu$ ) long, 0.29 times as long as the body, and 1.2 times the width of the head across the eyes; segment I somewhat wrinkled with some spinulae, segment II with wrinkles arranged as an irregular network almost without spinulae; segments III-V (fig. 573) with ring-shaped secondary rhinaria, the rings are not closed on the dorsal side, with a space of 5-30  $\mu$ ; between the rhinaria are 3-5 concentric imbrications, dorsally and ventrally with interconnections, and here and there a network structure; the rhinaria are 3-4  $\mu$  wide. The primary rhinaria are moulded with the secondary rhinaria to a complex structure, wider than other annular rhinaria; on segment V a circular rhinarium is located anterior to the last annular rhinarium; segment III with 17-25 annular rhinaria, IV with 7-9, V with eight; hairs are lacking on segments III and IV; on V one hair, 25  $\mu$  long and three apical setae, 14  $\mu$  long. Length of segment III, 358  $\mu$ , 2.7 times as long as IV, 2.4 times as long as V, and 1.26 times as long as IV plus V; segment IV, 134  $\mu$  long, 0.90 times as long as V; segment V, 149  $\mu$  long, the processus terminalis 2-14  $\mu$ . The last rostral segment 98  $\mu$  long, 0.83 times as long as the second tarsal segment of the hind leg, without accessory hairs; length of the stylets 435  $\mu$ . Eyes compound.

Thorax.— Sides of the prothorax pale brown, meso- and metathorax brown. Fore wing (fig. 574) medial vein once branched, median I, 1.5 times as long as the distance

from the base of the fork to the base of the anal vein; anal vein and cubitus usually not united at the base; the hind wing with two oblique veins. The femora almost smooth, the tibiae and second tarsal segments densely with spinulose imbrications, the spinulae 1-4  $\mu$  long; the tibia of the fore leg 748  $\mu$  long, 1.26 times as long as the width of the head across the eyes, length of the hairs of the hind tibia 45  $\mu$ ; chaetotaxy of first tarsal segments, 3, 3, 2, the lateral hairs 2.6 times as long as the middle hair; length of hairs of the first tarsal segment of the hind leg 56  $\mu$ , the hairs with expanded tips; the four apical hairs of the second tarsal segment of the hind leg with expanded tips, the dorsal hairs 60  $\mu$  long, the tips 3-4  $\mu$  wide; empodial hair of the hind leg 40  $\mu$  long, with expanded tip. Length of hind segments: femur plus trochanter 551  $\mu$ , tibia 829  $\mu$ , 1.50 times as long as the femur, and 1.40 times the width of the head across the eyes; first tarsal segment 45  $\mu$ , second tarsal segment 118  $\mu$ .

Abdomen.— (fig. 575). Abdominal segments I-VII colourless, each segment on each side with one marginal hair, 86-152  $\mu$  long, the tergites I-V each with 7-9 hairs, dorsally on segment IV, 186  $\mu$  long, ventrally 55  $\mu$ . Tergite VI with one hair, tergite VII with two. Tergite VIII very pale brown with two spinal hairs, 140  $\mu$  long, and on each side one lateral hair. Siphunculi situated on segment VI, a brown ring with a diameter of 41  $\mu$ , and about 20  $\mu$  high. Cauda (fig. 576) at the base 176  $\mu$  wide and 108  $\mu$  long, cone-shaped with an almost straight posterior margin, 25  $\mu$  wide; the sides are slightly curved inwards, but a constriction is lacking, with 12 hairs on the distal 35  $\mu$  length of the cauda, the longest hair 41  $\mu$ . Subanal plate bilobed, with 15 hairs, the longest 73  $\mu$ . Subgenital plate with 14 anterior hairs, 57  $\mu$  long, and 18 posterior hairs, 14 of which along the posterior margin, the longest 53  $\mu$ . Gonapophyses two, each with six hairs, 30  $\mu$  long, and two  $\mu$  wide near the base. Spiracles on abdominal segments II-V.

First stage larvae of apterae are lacking in the collections; a description of a last stage larva follows here:

Last stage larva of apterous viviparous female (figs. 577-579; description of one specimen): Body length 1000  $\mu$ , the width 715  $\mu$ . The head very pale brown, the rest of the body colourless, antennae, eyes and legs pale brown. Antennae with three segments, 120  $\mu$  long, length of hair on segment I, 10  $\mu$ ; on II, 12  $\mu$ ; segment III, 78  $\mu$  long, the processus terminalis 10  $\mu$ , distance from the penultimate rhinarium to the top of the antenna 43  $\mu$ , hairs are lacking, length of the apical setae 15  $\mu$ . Number of marginal hairs on each side of prothorax two, mesothorax three, metathorax three, abdominal segment I, two, and segments II-VII each one; number of hairs on pronotum six, mesonotum 11, metanotum 10, abdominal tergite I seven, II four, III four, IV two, V two, VI one and VII zero; length of hairs on anterior segments 65-102  $\mu$ , on abdominal segments III-VII, 30-55  $\mu$ . Wax glands occur as a band with spaces along the margins of the body, and as roundish areas pleurally on the tergites of thorax and abdomen; the glands (figs. 578, 579) are about circular, 2.5-4.0  $\mu$  diameter, with a wall about 0.5  $\mu$  thick, and with a space between the glands of 0-2  $\mu$ ; a structure of the membrane is not observable. On the head are two marginal groups of wax glands close to the base of the antennae, and not protruding into the middle area. A marginal band of wax glands runs from behind the eyes to along the posterior margin of segment VIII and has a space at the posterior margin of pro-, meso-, metathorax, abdominal segment I, and abdominal segment VII; the band is observable dorsally and ventrally, and is all together 50-80  $\mu$  wide: Siphunculi on abdominal seg-

ment VI, the pore 27  $\mu$  wide. Spiracles on the thorax only, on each side one between fore- and midleg, one between mid- and hind leg.

Last stage larvae of alate viviparous females have no roundish wax glands on the head, but a large broad marginal band of roundish wax glands is present on each of the thoracic segments. The abdominal tergites I-IV are completely covered by roundish wax glands with a diameter of 2-4  $\mu$ ; on tergites V-VIII next to areas with roundish wax glands, areas are observed with pores, about 0.5  $\mu$  wide.

Host plant records.— Specimens were collected in Java: *Quercus spec.*, Dieng plateau on Mt. Dieng (2060 m), beginning iv.1915, 4.iv.1916, 20.iv.1916, 30.viii.1916, leg. P. van der Goot, in the collection at the British Museum (Natural History), London, and at Laboratorium voor Entomologie, Wageningen.

The aphids live in considerable numbers on the lower side of the leaves.

Alatae were collected 20-iv-1916, and 30-viii-1916.

Etymology.— Arboris, of a tree, name given to this species by Van der Goot (1917).

### Acknowledgements

Thanks are due to the Laboratorium voor Entomologie, Wageningen, The Netherlands, for enabling me to study Van der Goot's specimens, and to Dr R.L. Blackman, Department of Entomology, British Museum (Natural History) who gave me the opportunity to study specimens present in the collection of the Museum, and for his comments on some of the species. I am greatly indebted to Drs J. van Tol for his help and advice, and to Mrs P.A. Chadwick, Bennekom, The Netherlands, for her help in correcting the manuscript. Dr A. Polaszek (International Institute of Entomology) for reviewing the manuscript. I also wish to thank my wife Anna Noordam-Kowalska for converting my pencil drawings into pen and ink drawings.

### References

- Baehr, V.B. de, 1920. Recherches sur la maturation des oeufs parthénogénétiques dans l'*Aphis palmae*.— Cellule 30 (2): 317-349.
- Boisduval, J.A., 1867. Essai sur l'entomologie horticole: 1-640.— Paris.
- Buckton, G.B., 1893. Notes on Indian aphides.— Indian Mus. Notes 3: 87-88.
- Buckton, G.B., 1894. Notes on Indian Aphidae.— Indian Mus. Notes 3: 108-109.
- Doncaster, J.P., 1966. Notes on Indian aphids described by G.B. Buckton.— Entomologist 99: 157-160.
- Docters van Leeuwen-Reijnvaan, J. and W.M. Docters van Leeuwen, 1926. The Zooecidia of the Netherlands East Indies: 1-601.— Batavia.
- Docters van Leeuwen-Reijnvaan, J. and W.M. Docters van Leeuwen, 1941. The Zooecidia of the Netherlands East Indies. Suppl. I.— Ned. Kruid. Arch. 51: 122-251.
- Eastop, V.F. and D. Hille Ris Lambers, 1976. Survey of the World's aphids: 1-573.— The Hague.
- Essig, E.O., 1932. A genus and a species of the family Aphididae new to North America.— Univ. Calif. Publ. Entomol. 6: 1-8.
- Franssen, C.J.H. and L.M.J. Tiggelovend, 1935. De vijanden en de ziekten der Orchideeën op Java en hunne bestrijding: 1-83.— Batavia.
- Ghesquière, J., 1934. In: Mayné, R. and J. Ghesquière. Hemiptères nuisibles aux végétaux du Congo belge. Famille des Aleurodides.— Anns Gembloux 40: 29-31.
- Ghosh, A.K. and D.N. Raychaudhuri, 1973. Studies on the aphids (Homoptera: Aphididae) from eastern India. XV. A study of *Nipponaphis* Pergande and related genera with descriptions of a new genus and eight new species from eastern India.— Kontyû 41 (2), 148-165; 41 (4), 477-496.
- Ghosh, L.K., 1972. A new species and a subspecies of aphids (Homoptera: Aphididae) from India.— Orient. Insects 6 (3): 299-304.

- Ghosh, M.R., P.K. Pal and D.N. Raychaudhuri, 1974. Studies on the aphids (Homoptera: Aphididae) from eastern India. 21. The genus *Astegopteryx* Karsch and other related genera (Homaphidinae) with descriptions of three new genera and two new species.— Proc. Zool. Soc. Calcutta 27: 81-116.
- Goot, P. van der, 1912. Über zwei noch unbeschriebene javanische Blattlaus-Arten.— Tijdschr. Ent. 55: 319-332.
- Goot, P. van der, 1915. Beiträge zur Kenntnis der Holländischen Blattläuse. Eine Morphologisch-Systematische Studie: 1-600.— Haarlem, Berlin.
- Goot, P. van der, 1917. Zur Kenntnis der Blattläuse Java's.— Contrib. Faune Indes Néerl. 1 (3): 1-301.
- Goot, P. van der, 1918. Notes on Oriental Aphididae.— Tijdschr. Ent. 60: 112-127.
- Hille Ris Lambers, D., 1933. On the species of *Astegopteryx* Karsch from *Styrax benzoin* Dryand.— Misc. Zool. Sumatrana 76: 1-4.
- Hille Ris Lambers, D., 1953. Notes on aphids from *Cocos nucifera*.— Agric. J. Dep. Agric. Fiji 24 (3,4): 93-95.
- Hille Ris Lambers, D. & R. Takahashi, 1959. Some species of *Thoracaphis* and of nearly related genera from Java (Homoptera, Aphididae).— Tijdschr. Ent. 102: 1-16.
- Karsch, 1890. *Astegopteryx* Karsch, nov. gen.— Ber. Deut. Bot. Ges. 8: 51-52. (In Tschirch, 1890).
- Liao Huey-Tarn, 1976. Bamboo aphids of Taiwan.— Quart. J. Taiwan Mus. 29: 499-586.
- Lichtenstein, J., 1882. *Coccus lataniae* = *Boisduvalia lataniae* = *Cerataphis lataniae*.— Bull. Soc. ent. Fr. 2: 74-75.
- Noordam, D., 1986. Aphids of Java. Part 2. *Sinomegoura* Takahashi, 1960 (Homoptera: Aphididae), with a new species from *Coffea*.— Zool. Med. Leiden 60: 39-61, figs. 1-30.
- Noordam, D. & D. Hille Ris Lambers, 1985. Aphids of Java. Part 1. Introduction, five new species of *Taiwanaphis* Takahashi, 1934, with re-description of the genus (Homoptera: Aphididae).— Zool. Verh. Leiden 219: 1-45, figs. 1-13.
- Pergande, T., 1906. Description of two new genera and three new species of Aphididae.— Entomol. News 17: 205-210.
- Suenaga, H., 1933. Eine neue Gattung und Art von Aphididen aus Japan.— Kontyû 7: 249-252.
- Szelegiewicz, H., 1968. Notes on some aphids from Vietnam, with description of a new species (Homoptera, Aphidodea).— Ann. Zool. (Poland) 25 (12): 459-471.
- Takahashi, R., 1921. Aphididae of Formosa. Part 1.— Agric. Exp. Sta. Govt. Formosa Rep. 20: 1-97.
- Takahashi, R., 1923. Aphididae of Formosa. Part 2.— Dep. Agr. Govt. Res. Inst. Formosa Rep. 4: 1-173.
- Takahashi, R., 1924. Aphididae of Formosa. Part 3.— Dep. Agr. Govt. Res. Inst. Formosa Rep. 10: 1-121.
- Takahashi, R., 1925. Aphididae of Formosa. Part 4.— Dep. Agr. Govt. Res. Inst. Formosa Rep. 16: 1-65.
- Takahashi, R., 1927a. Some Aphididae collected by Prof. F. Silvestri in China.— Boll. Lab. Zool. Gen. and Agri., Portici Italia 20: 147-149.
- Takahashi, R., 1927b. A new species of Aphididae from Formosa and three species new to China.— Trans. Natur. Hist. Soc. Formosa 17: 388-390.
- Takahashi, R., 1929a. Notes on some Formosan Aphididae.— Trans. Natur. Hist. Soc. Formosa 19 (100): 92-103.
- Takahashi, R., 1929b. Notes on some Formosan Aphididae (2).— Trans. Natur. Hist. Soc. Formosa 19: 247-259.
- Takahashi, R., 1931. Aphididae of Formosa Part 6.— Dep. Agr. Govt. Res. Inst. Formosa Rep. 53: 1-127.
- Takahashi, R., 1935a. Some new species of Aphididae from Sumatra.— Misc. Zool. Sumatrana 91: 1-9.
- Takahashi, R., 1935b. Three interesting aphids from Sumatra (Hemiptera).— Misc. Zool. Sumatrana 97: 1-8.
- Takahashi, R., 1938. List of aphid genera proposed in recent years (Hemiptera).— Tenthredo 2: 1-18.
- Takahashi, R., 1941. Some foreign Aphididae (Homoptera).— Insecta Matsumurana 15: 146-150.
- Takahashi, R., 1950. List of Aphididae of the Malay Peninsula, with descriptions of new species (Homoptera).— Ann. Entomol. Soc. Amer. 43: 587-607.
- Takahashi, R., 1958. *Thoracaphis* and some related new genera of Japan (Aphididae, Homoptera).— Insecta Matsumurana 22: 7-14.
- Takahashi, R., 1959. Some aphids related to *Nipponaphis* Pergande in Japan (Homoptera).— Bull. Univ. Osaka Prefect. (B) 9: 1-8.

- Tao, C.C., 1966. Revision of Chinese Hormaphidinae, Aphidae, Homoptera.— Quart. J. Taiwan Mus. 19 (1/2): 165-179.
- Tschirch, A., 1890. Ueber durch *Astegopteryx*, eine neue Aphidengattung, erzeugte Zooecidien auf *Styrax Benzoin* Dryand.— Ber. Deut. Bot. Ges. 8: 48-53.
- Westwood, J.O., 1879. The fimbriated scale.— Gard. Chron. (2) 12: 796.
- Zehntner, L., 1897. Overzicht van de ziekten van het suikerriet op Java. 2e deel.— Med. Proefst. Oost-Java Nieuwe serie 37: 27-32.

Received: 22.ii.1990

Accepted: 31.viii.1990

Edited: J. van Tol

### Figures 1 - 579

The figures are drawn to different scales, and a scale line added to the figures. If the line is close to the figure concerned no mention is made of this in the text. Only when there could be some confusion about which scale line belongs to a figure, are scale line and figure mentioned. The numbers to the scale lines mean:

1 = 1 mm  
0.1 = 0.1 mm  
0.01 = 0.01 mm

Normal after first or second stage larva means: growing into later stages afterwards.

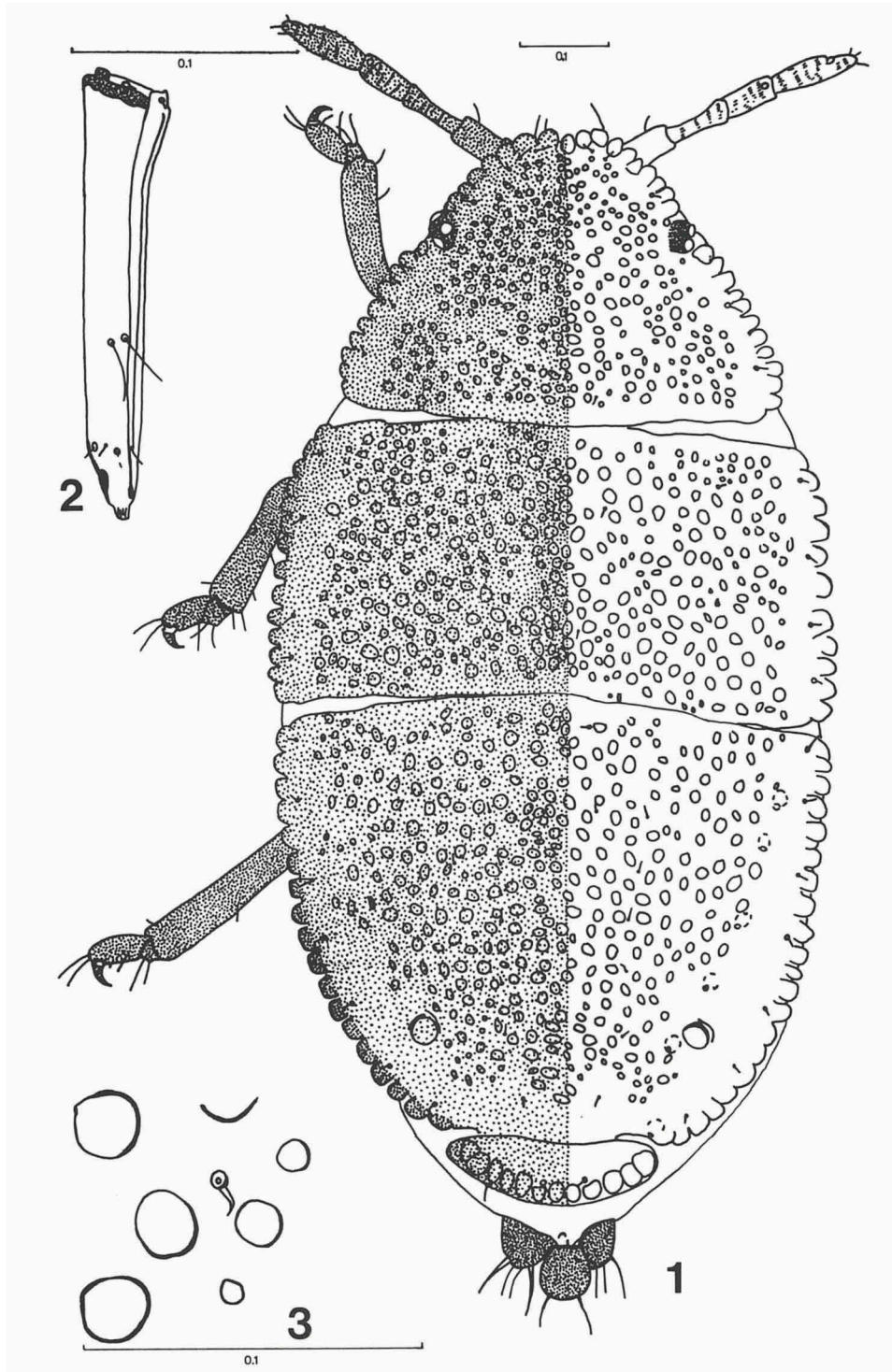

Figs. 1-3. *Aleurodaphis blumeae* Van der Goot, apterous viviparous ♀. Fig. 1, body dorsal side. Fig. 2, ultimate rostral segment. Fig. 3, oval structures on the dorsum.

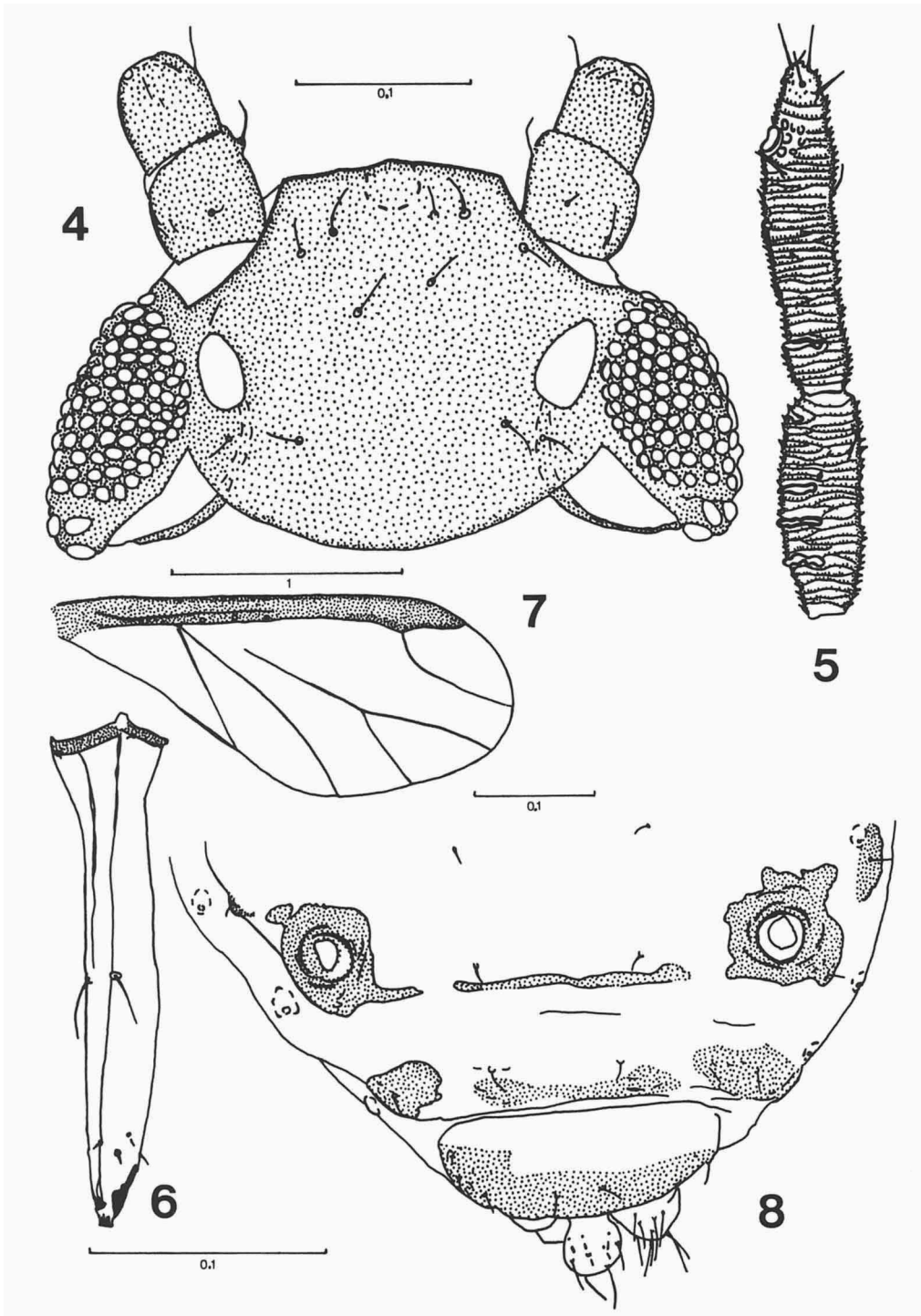

Figs. 4-8. *Aleurodaphis blumeae* Van der Goot, alate viviparous ♀. Fig. 4, head (bleached specimen), dorsal side. Fig. 5, antennal segments IV and V, dorsal sides. Fig. 6, ultimate rostral segment. Fig. 7, fore wing. Fig. 8, abdominal segments V-VIII dorsal sides. Scale line to fig. 5 is close to fig. 6.

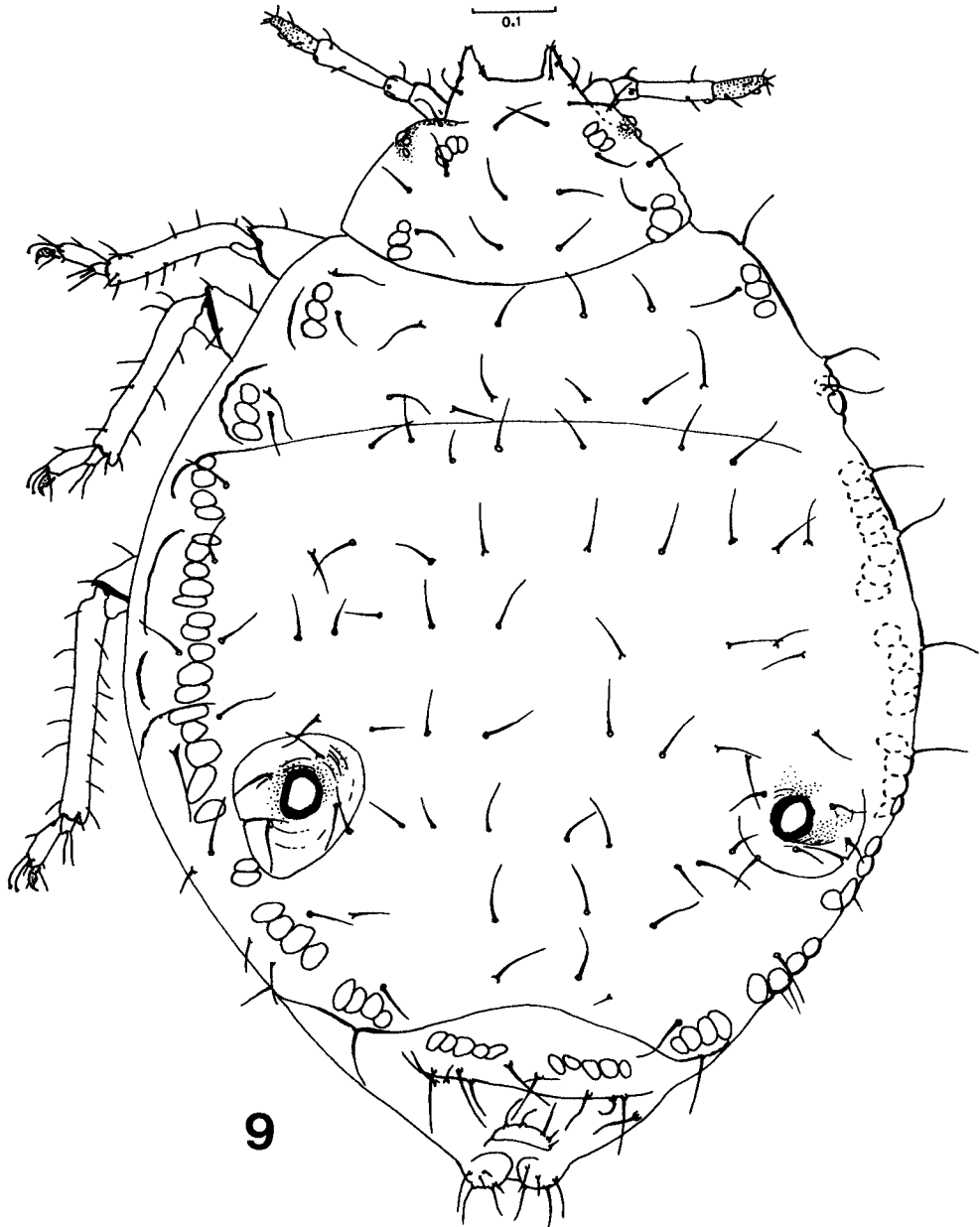

Fig. 9. *Astegopteryx bambusae* (Buckton), apterous viviparous ♀, dorsal side.



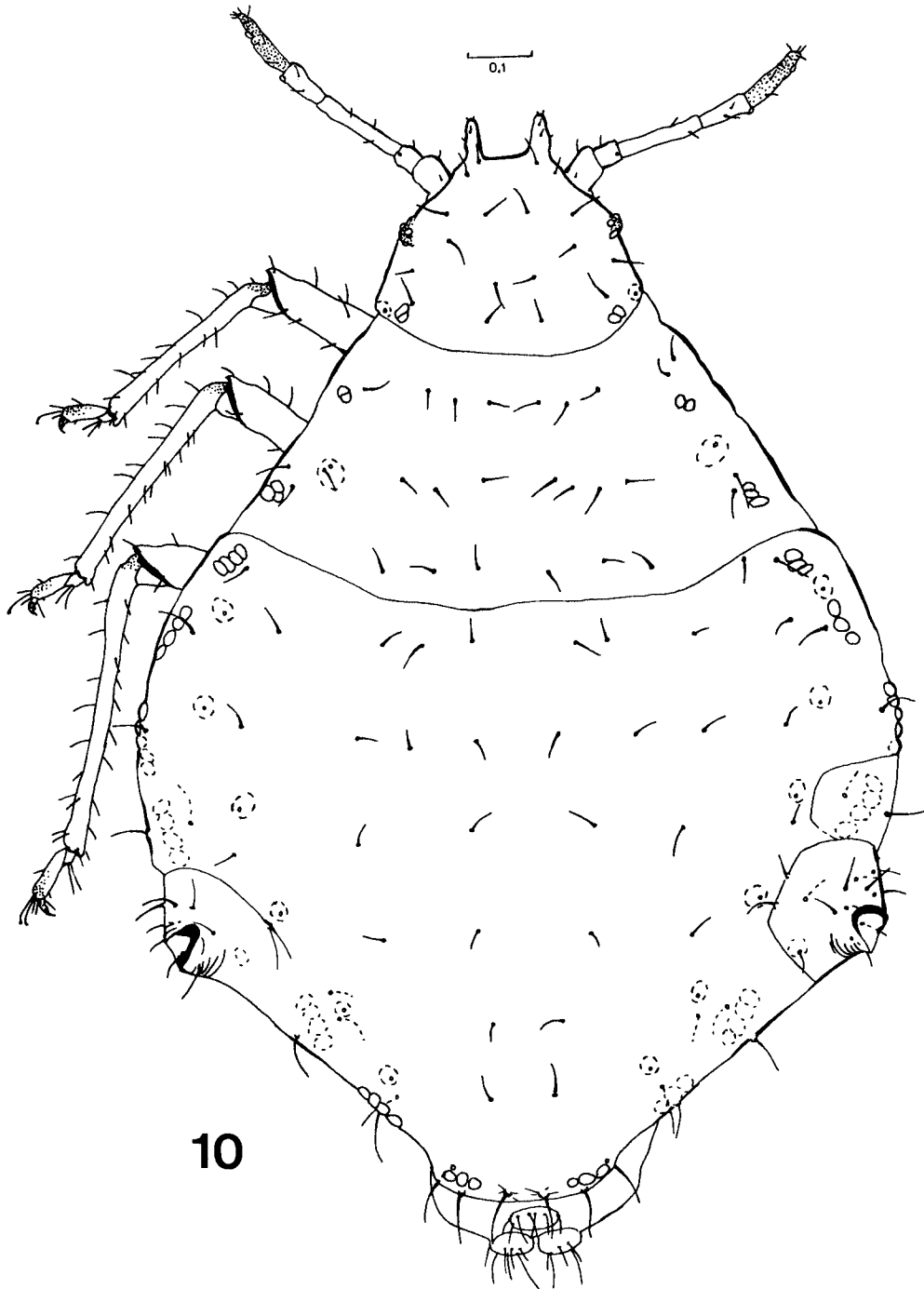
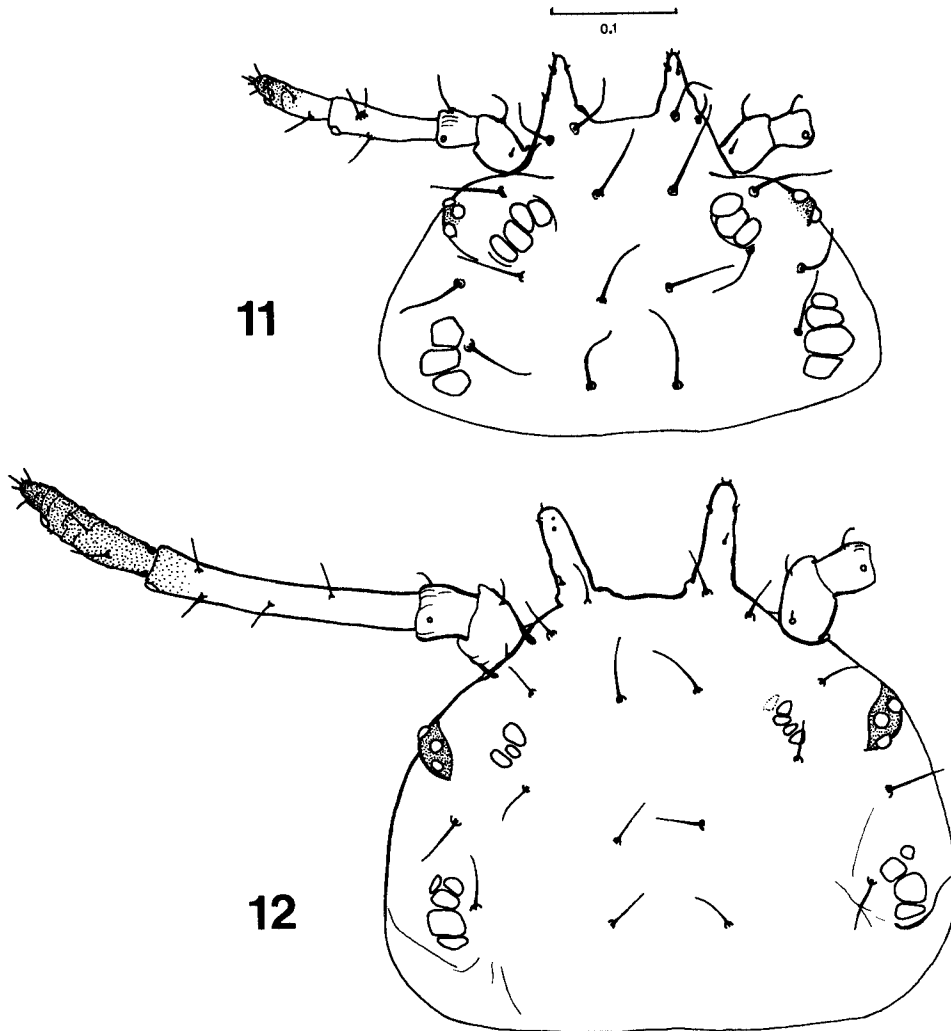
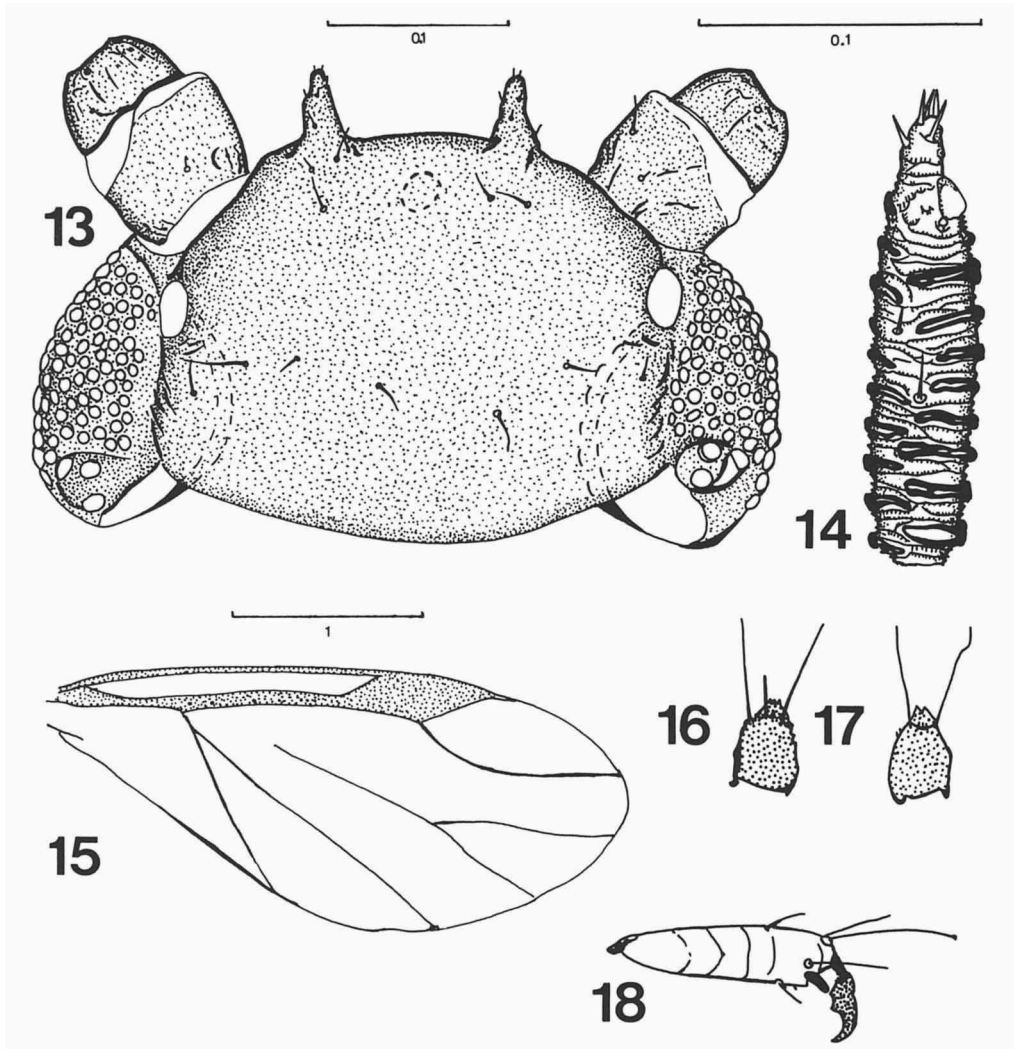

Fig. 10. *Astegopteryx bambusae* (Buckton), apterous viviparous ♀, dorsal side.



Figs. 11-12. *Astegopteryx bambusae* (Buckton), apterous viviparous ♀, dorsal sides of two heads.



Figs. 13-18. *Astegopteryx bambusae* (Buckton), alate viviparous ♀. Fig. 13, head, dorsal side. Fig. 14, antennal segment V, dorsal side. Fig. 15, fore wing. Figs. 16-17, first tarsal segments of fore- and hind leg respectively. Fig. 18, second tarsal segment of the hind leg. The longest scale line 0.1 to figs. 14, and 16-18.

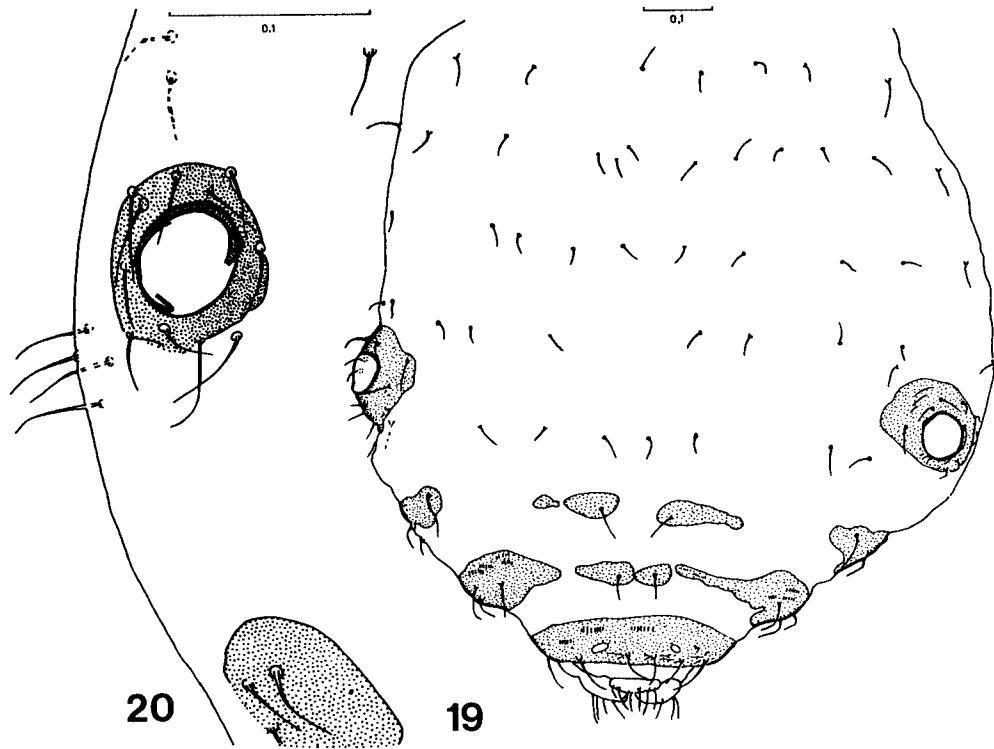

Figs. 19-20. *Astegopteryx bambusae* (Buckton), alate viviparous ♀. Fig. 19, abdominal segments I-VIII, dorsal sides. Fig. 20, margin of abdominal segments IV-VI.

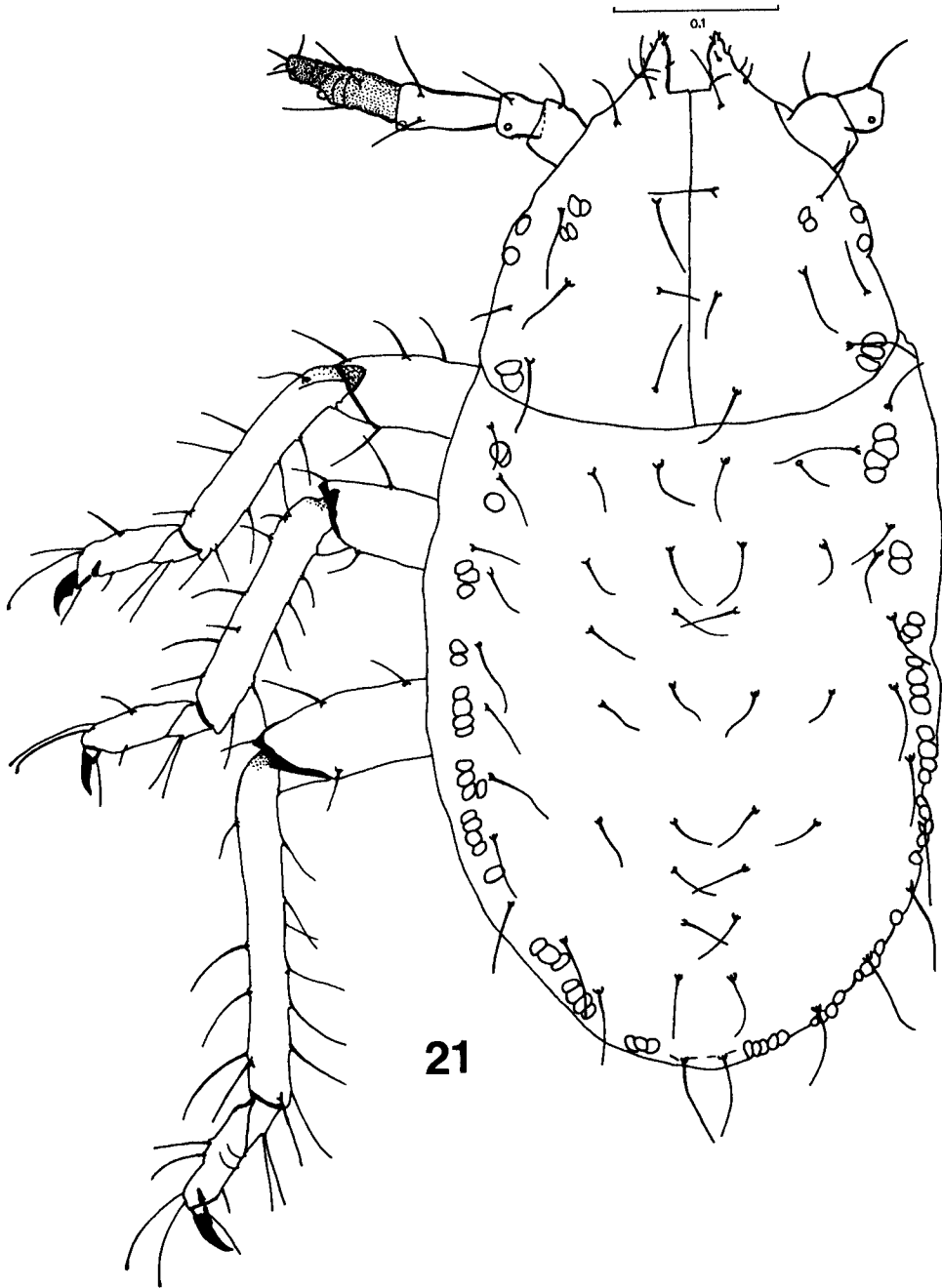

Fig. 21. *Astegopteryx bambusae* (Buckton), first stage larva, normal.

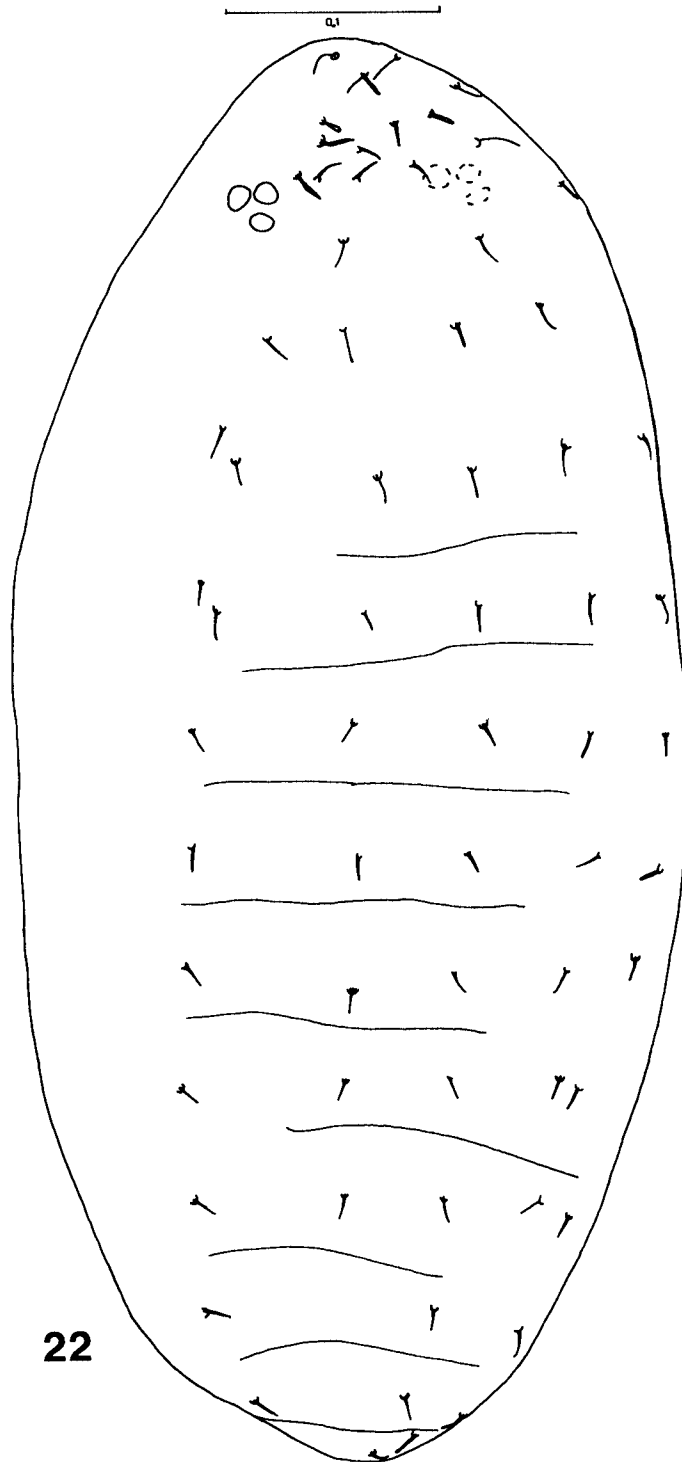
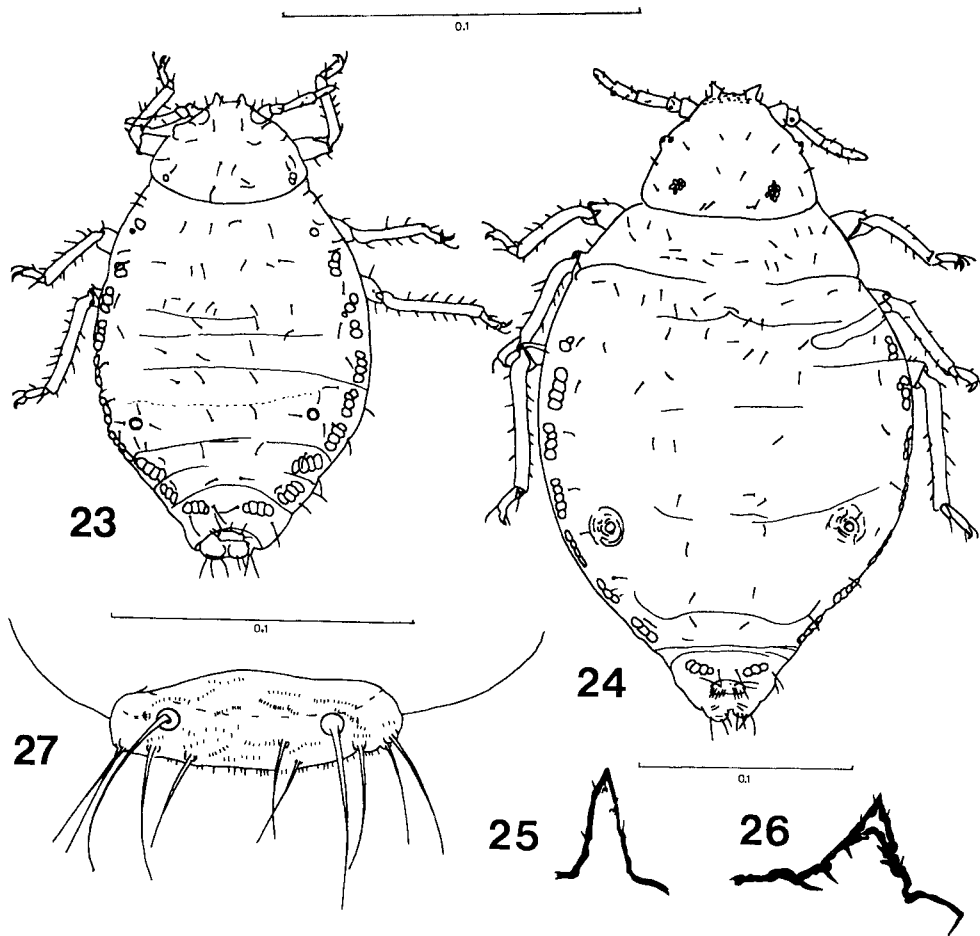
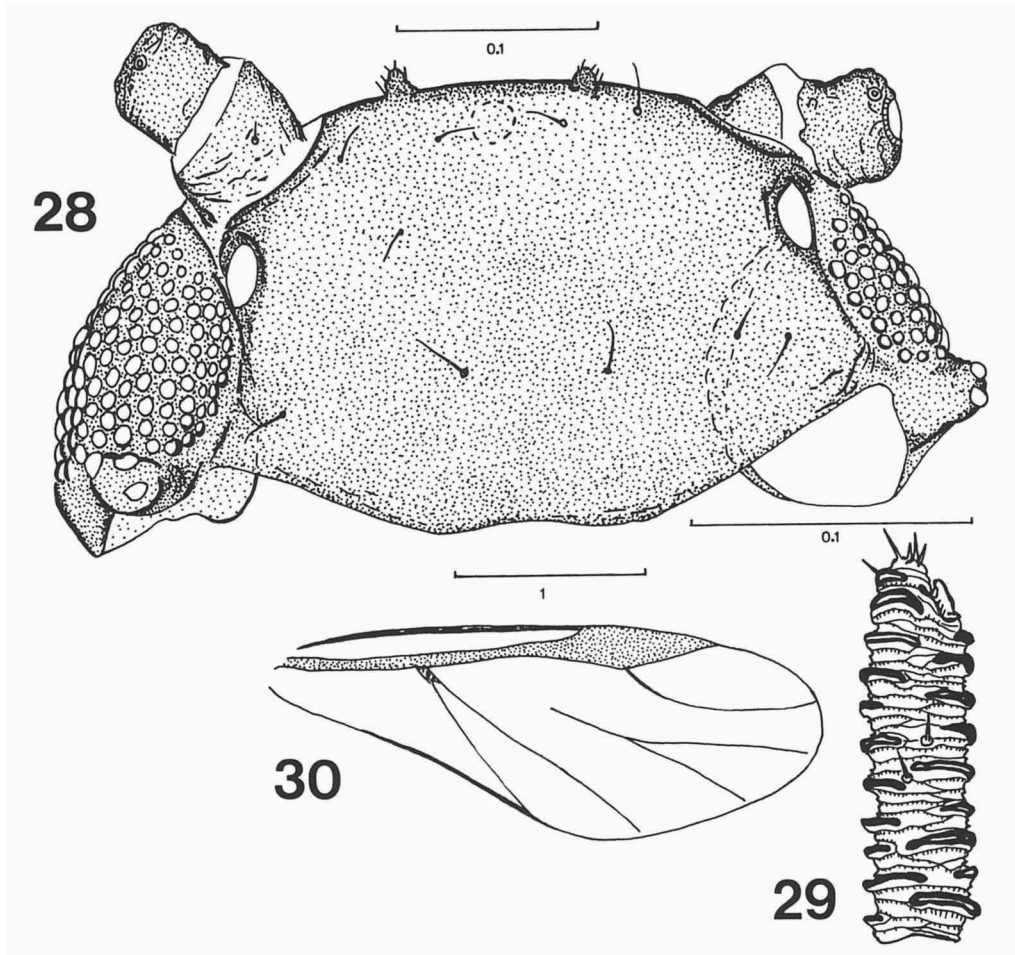

Fig. 22. *Astegopteryx bambusae* (Buckton), embryo inside alate viviparous ♀, dorsal side, but ventral hairs on the frons are also fully drawn.



Figs. 23-27. *Astegopteryx basalis* (Van der Goot), apterous viviparous ♀. Figs. 23-24, body, dorsal side. Figs. 25-26, horns. Fig. 27, cauda.



Figs. 28-30. *Astegopteryx basalis* (Van der Goot), alate viviparous ♀. Fig. 28, head dorsal side. Fig. 29, dorsal side of the antennal segment V. Fig. 30, fore wing.



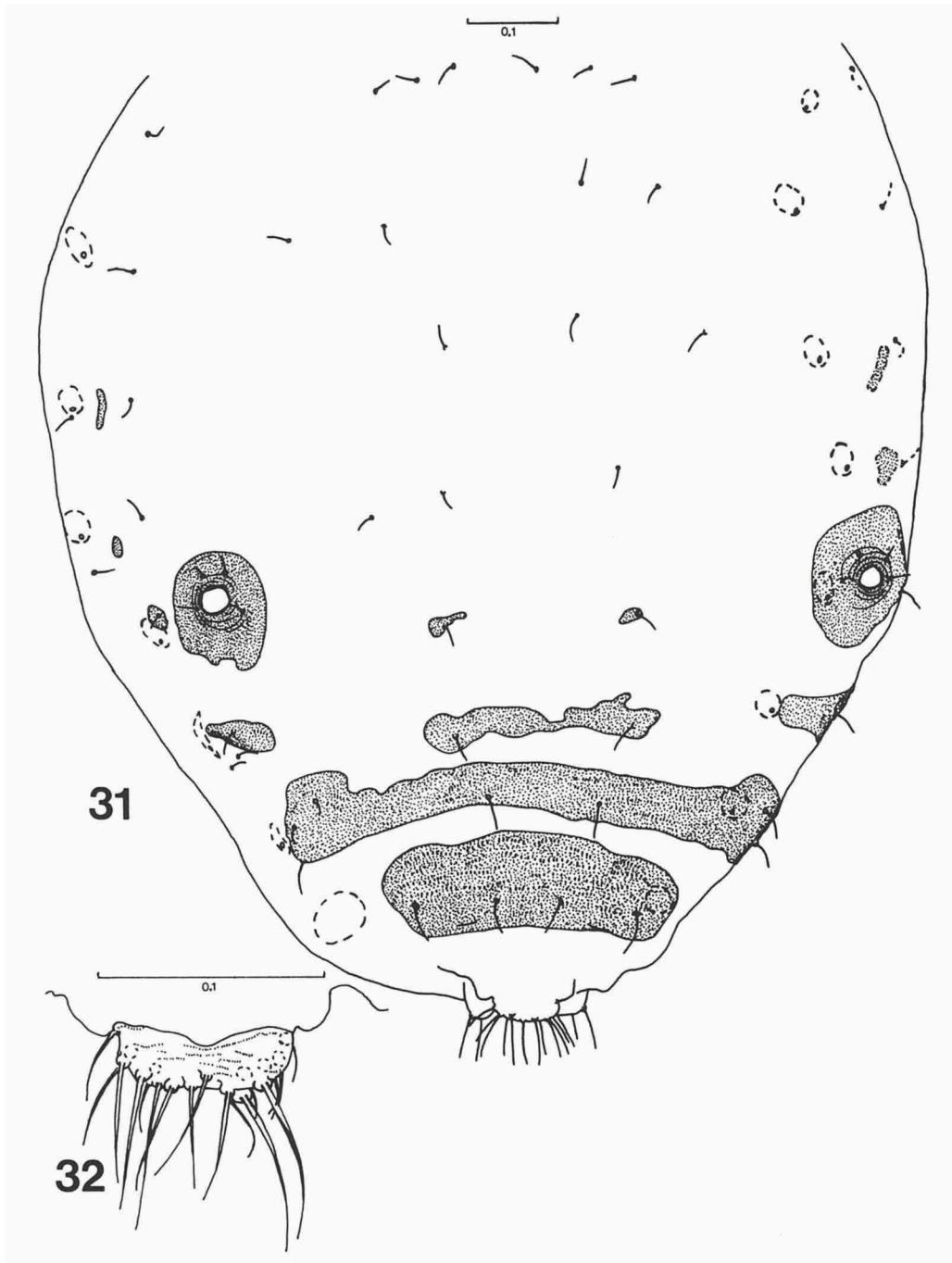

Figs. 31-32. *Astegopteryx basalis* (Van der Goot), alate viviparous ♀. Fig. 31, abdominal segments I-VIII, dorsal sides. Fig. 32, cauda.

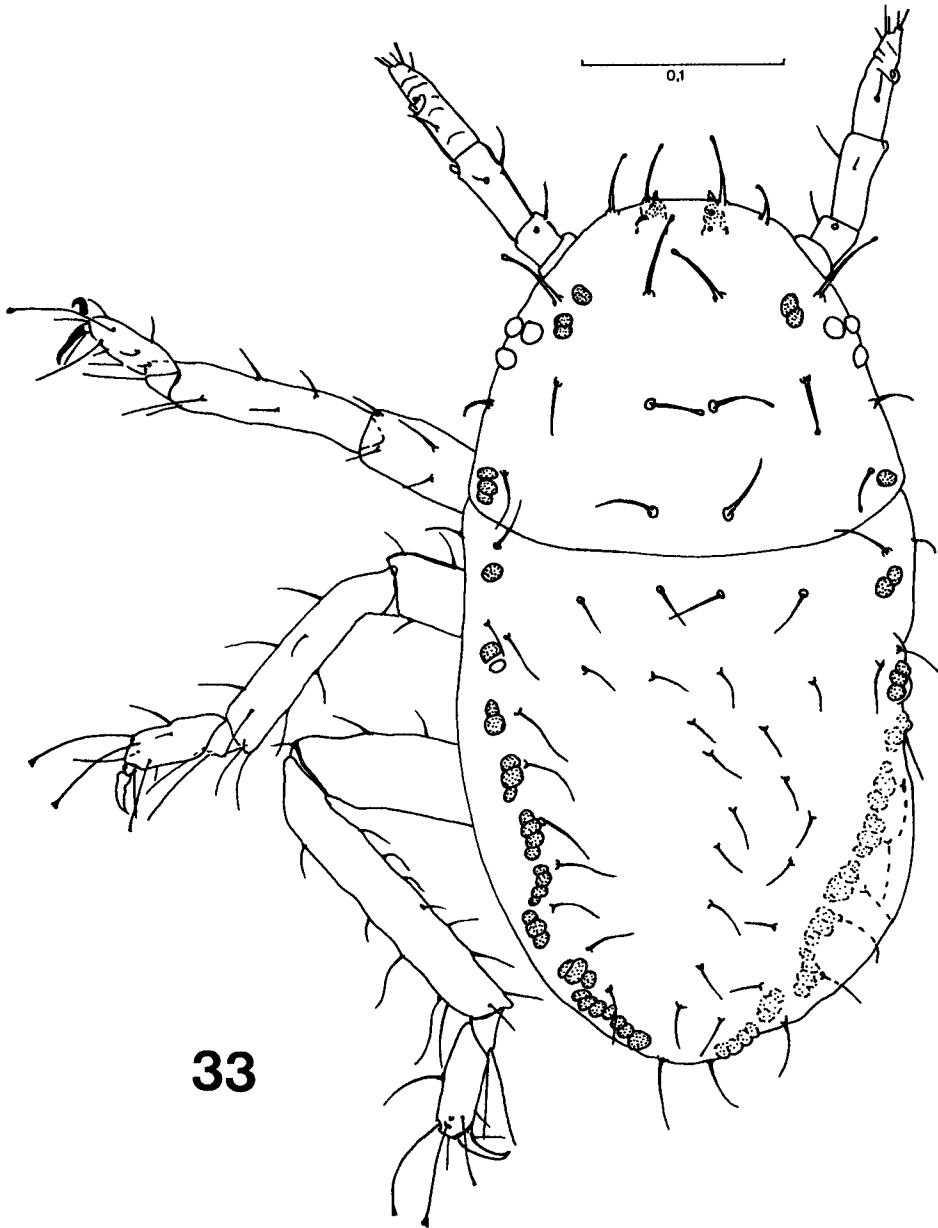
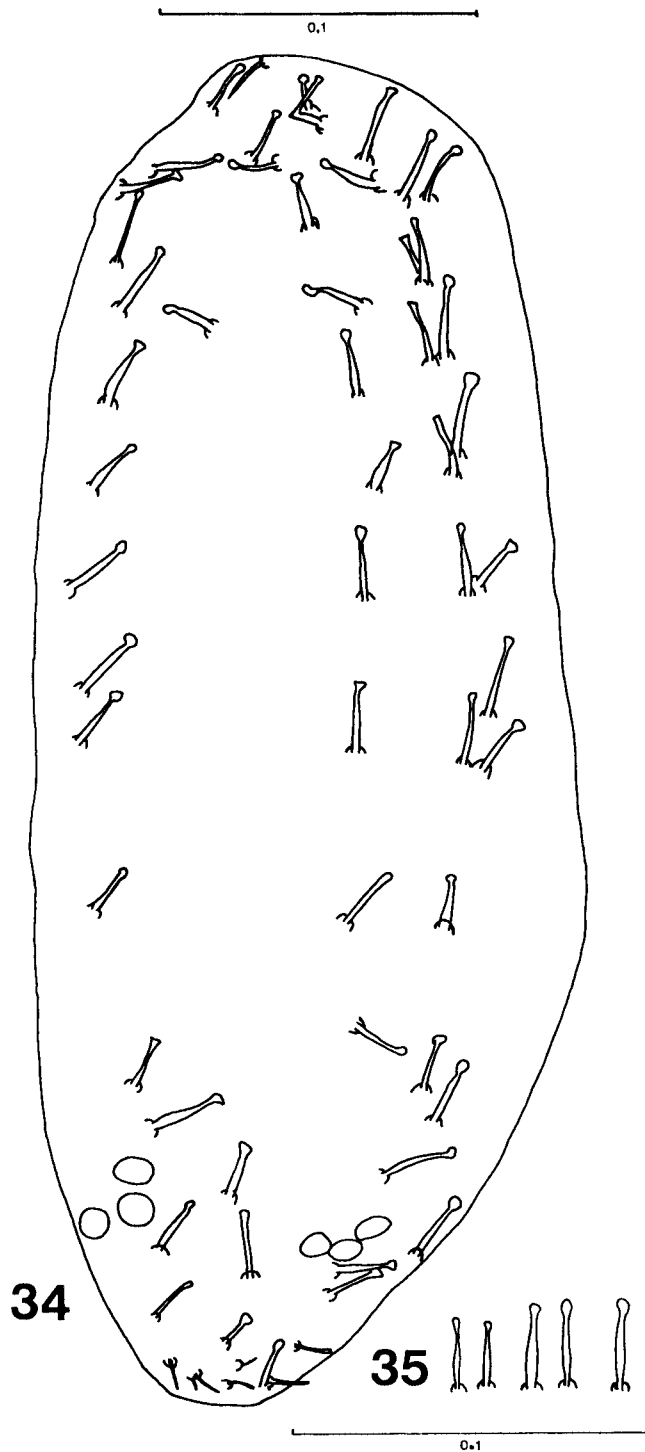

Fig. 33. *Astegopteryx basalis* (Van der Goot), first stage larva, normal.



Figs. 34-35. *Astegopteryx basalis* (Van der Goot), embryo inside alate viviparous ♀. Fig. 34, dorsal side of the body. Fig. 35, two hairs of the head (left), and three hairs of the abdomen (right).

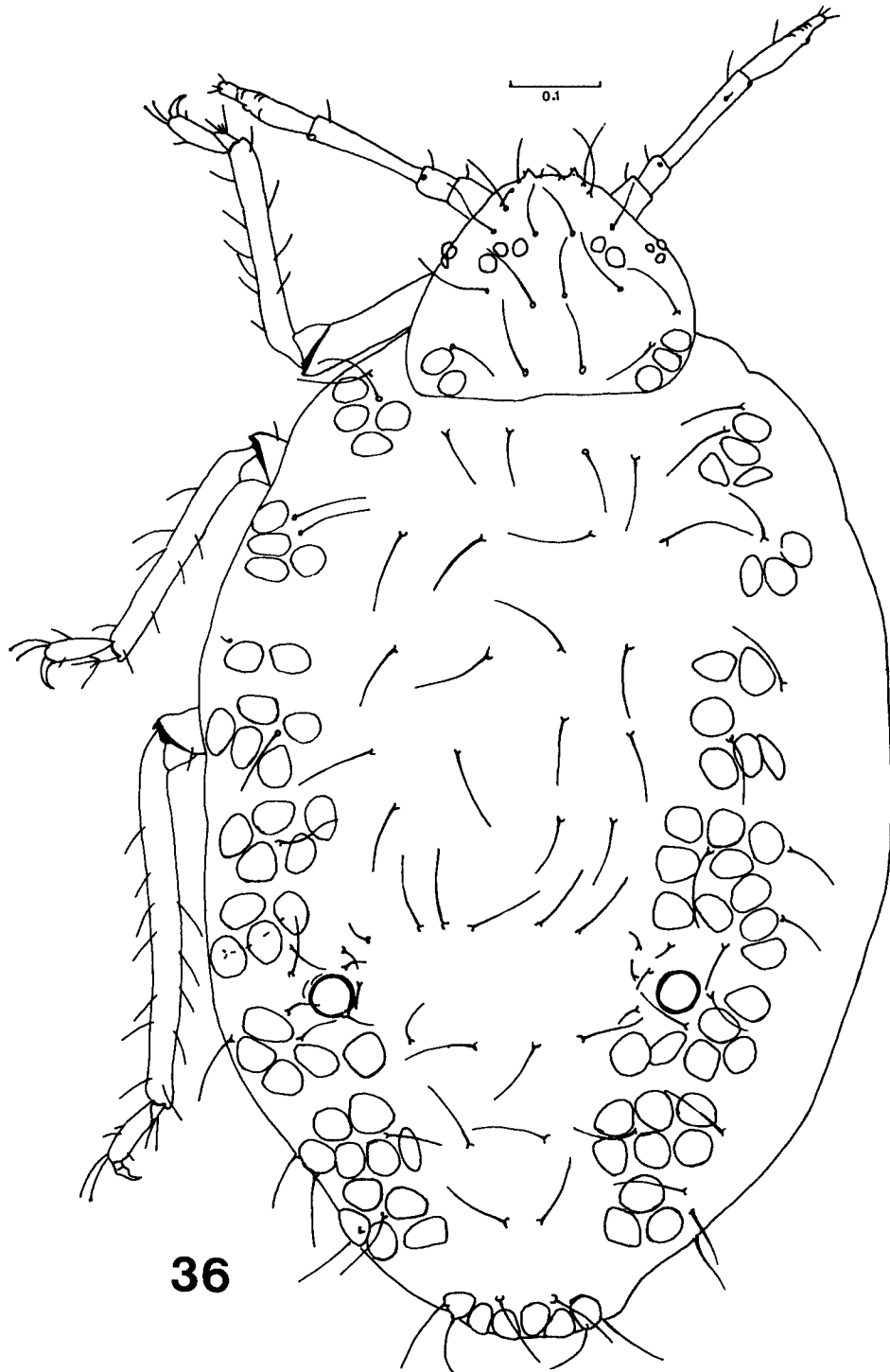

Fig. 36. *Astegopteryx glandulosa* spec. nov., apterous viviparous ♀, dorsal side of the body.

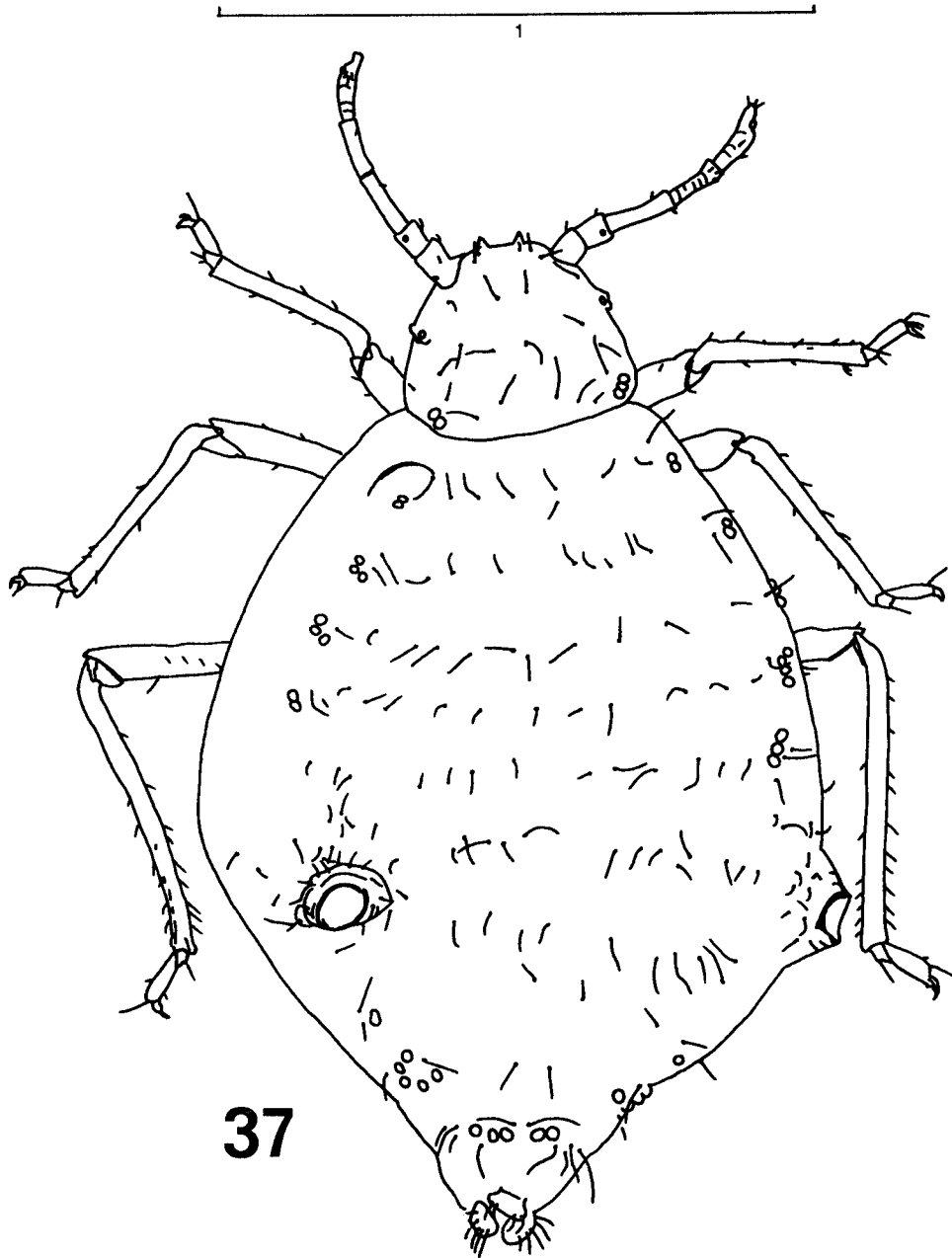
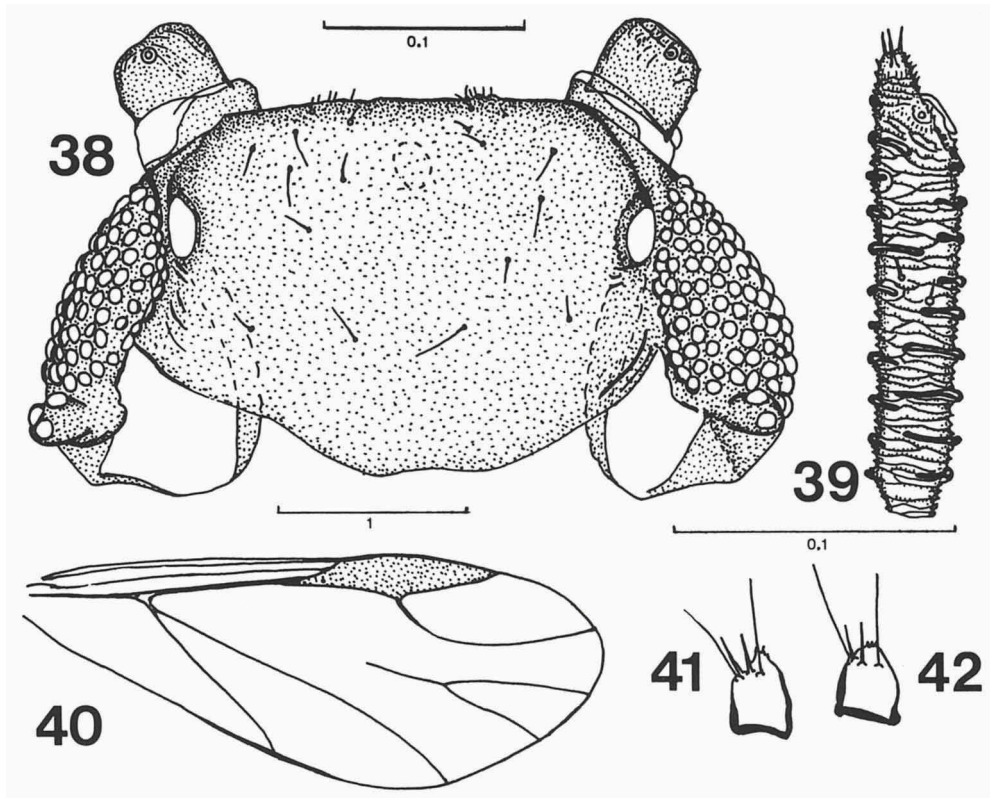
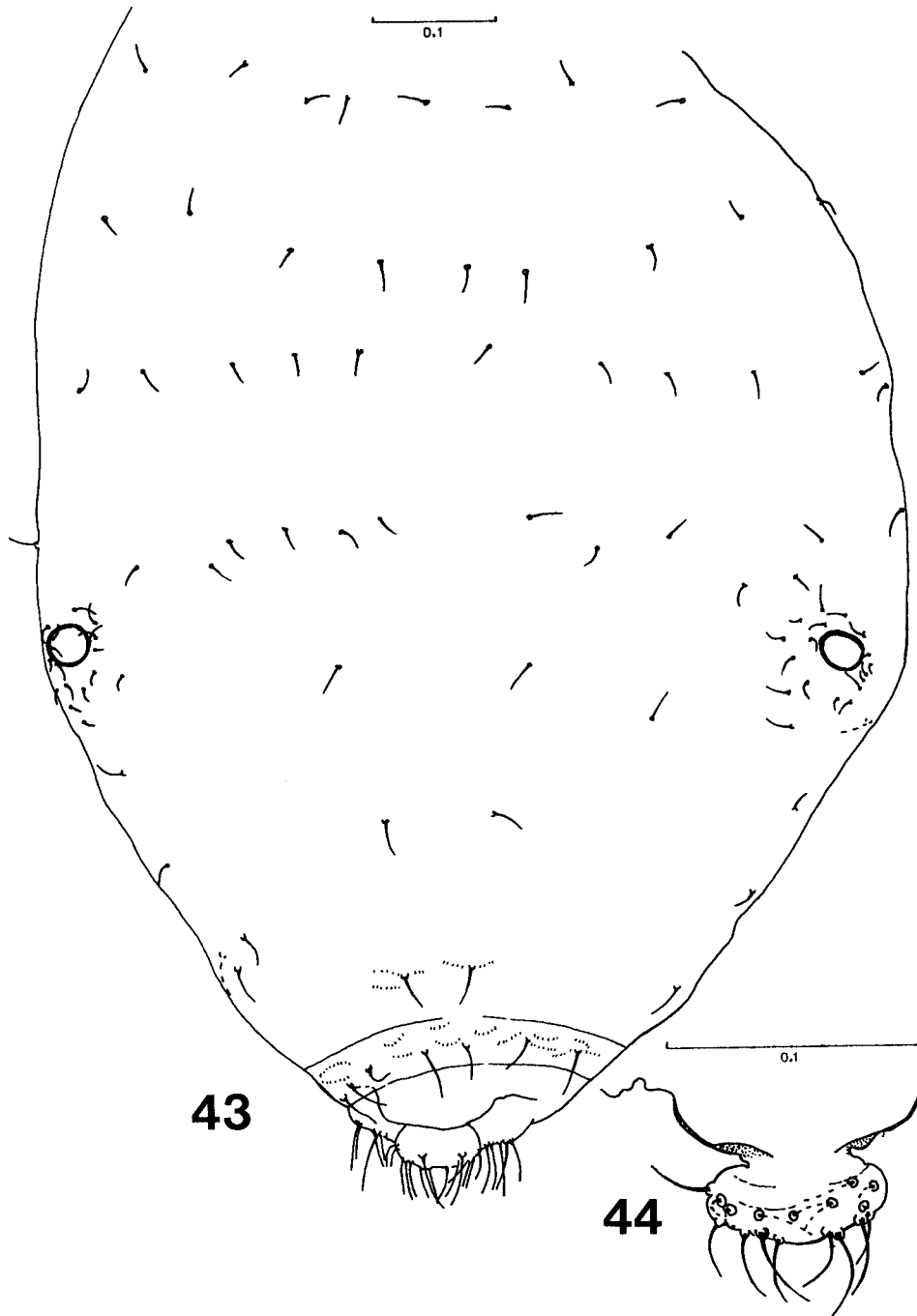

Fig. 37. *Astegopteryx glandulosa* spec. nov., apterous viviparous ♀, dorsal side of the body.



Figs. 38-42. *Astegopteryx glandulosa* spec. nov., alate viviparous ♀. Fig. 38, dorsal side of the head. Fig. 39, dorsal side of antennal segment V. Fig. 40, fore wing. Fig. 41, first tarsal segment of the foreleg. Fig. 42, first tarsal segment of the midleg. Longest 0.1 line to figs. 39, and 41-42.



Figs. 43-44. *Astegopteryx glandulosa* spec. nov., alate viviparous ♀. Fig. 43, abdominal segments I-VIII, dorsal sides. Fig. 44, cauda.

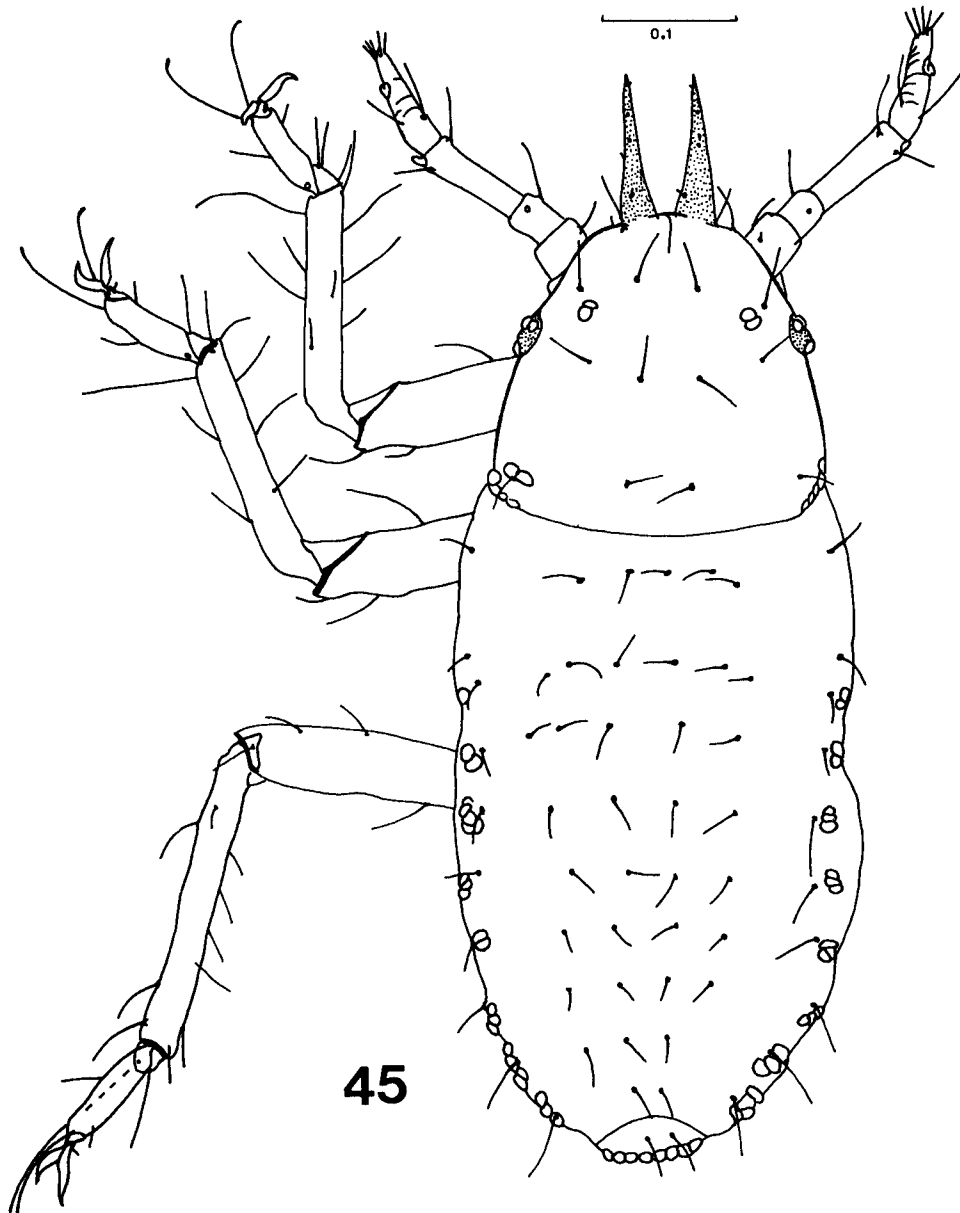

Fig. 45. *Astegopteryx glandulosa* spec. nov., first stage larva, normal.



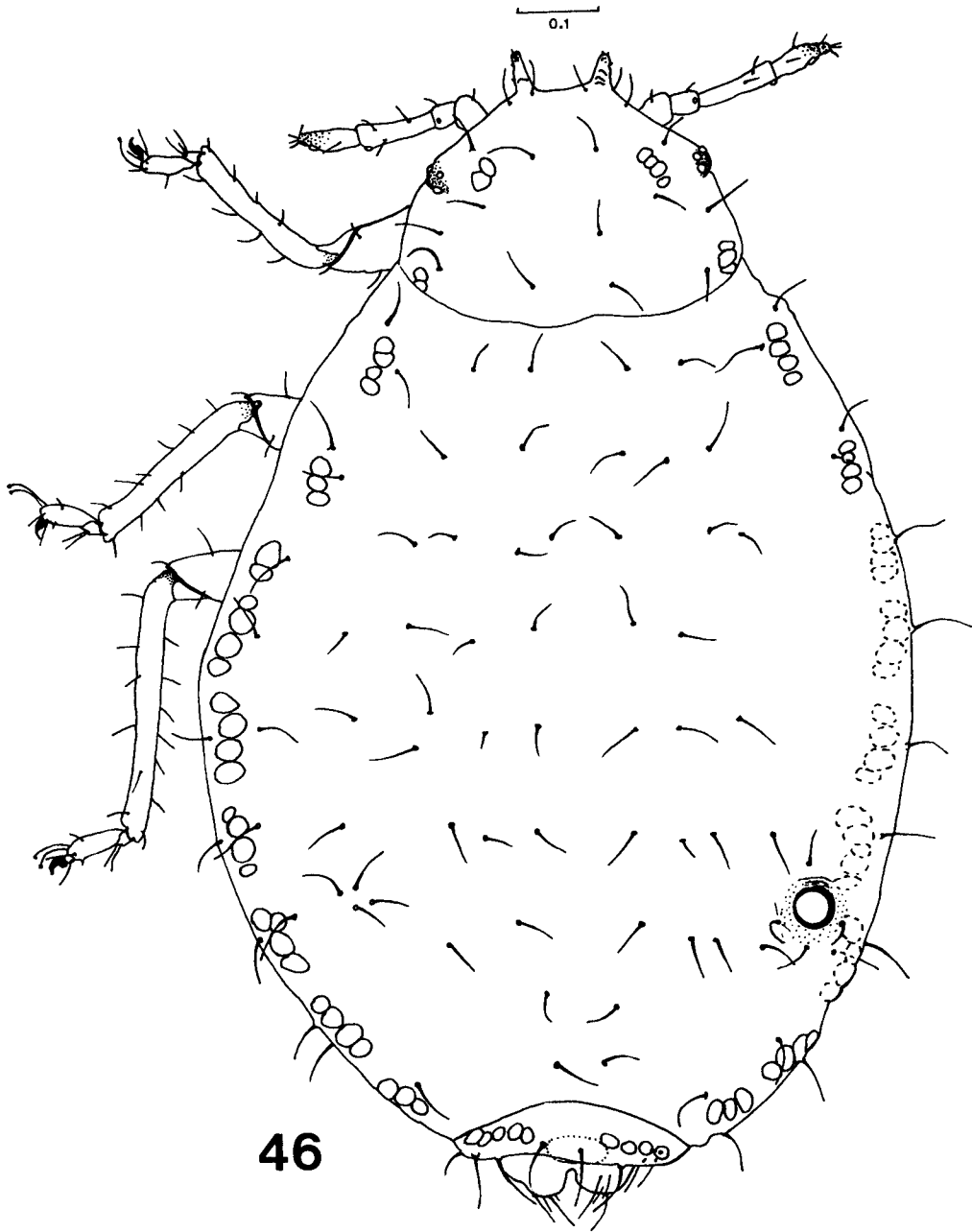

Fig. 46. *Astegopteryx minuta* (Van der Goot), apterous viviparous ♀, dorsal side.

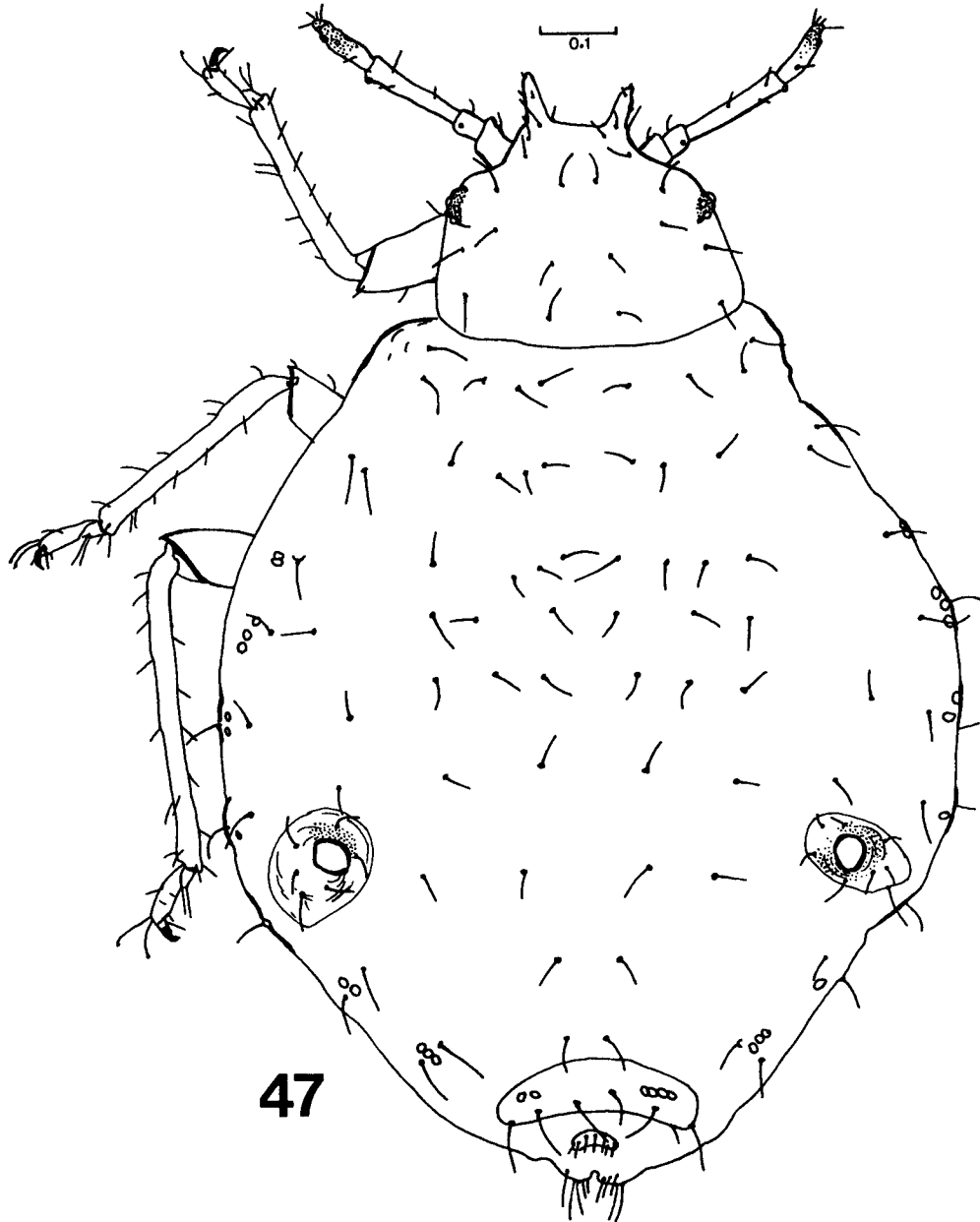

Fig. 47. *Astegopteryx minuta* (Van der Goot), apterous viviparous ♀, dorsal side.

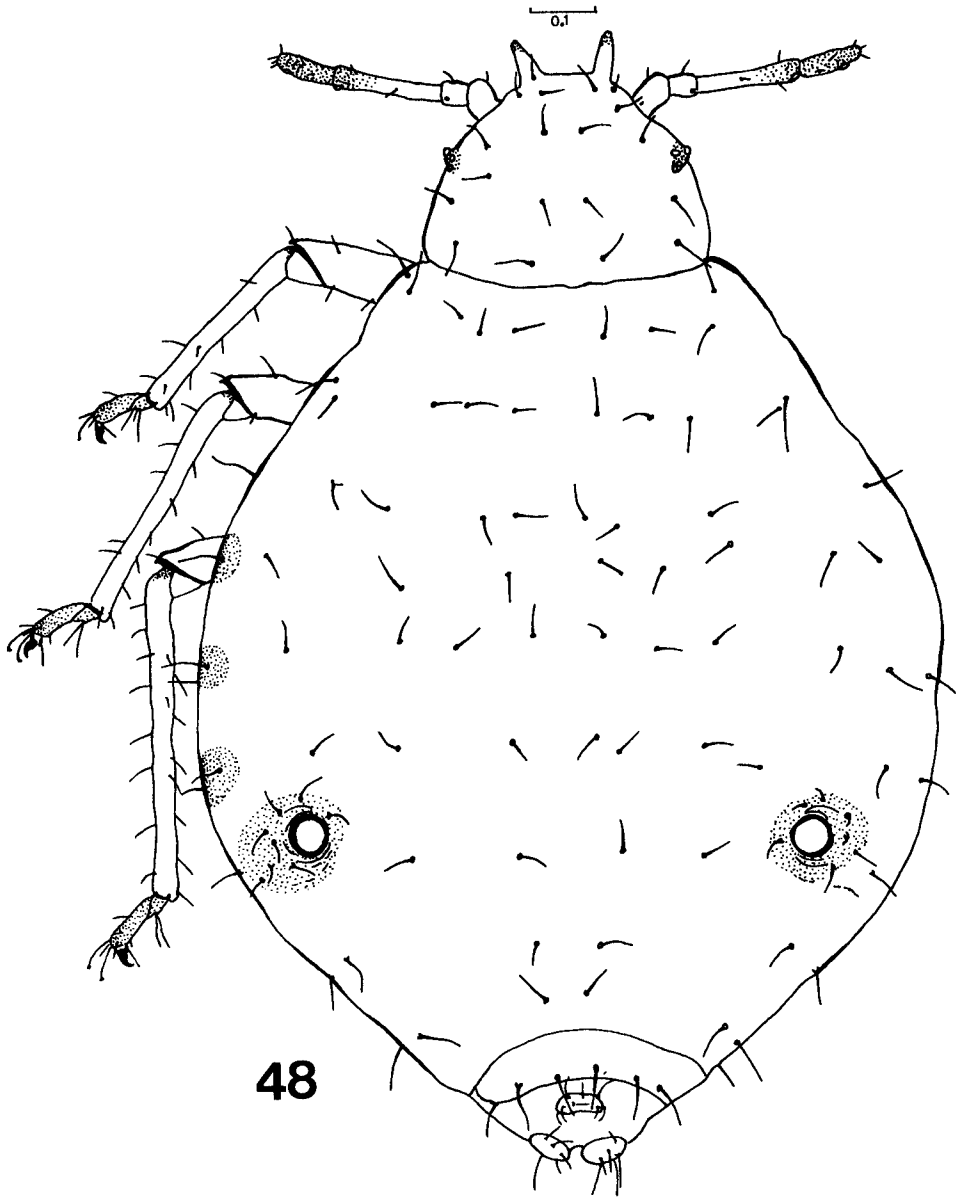
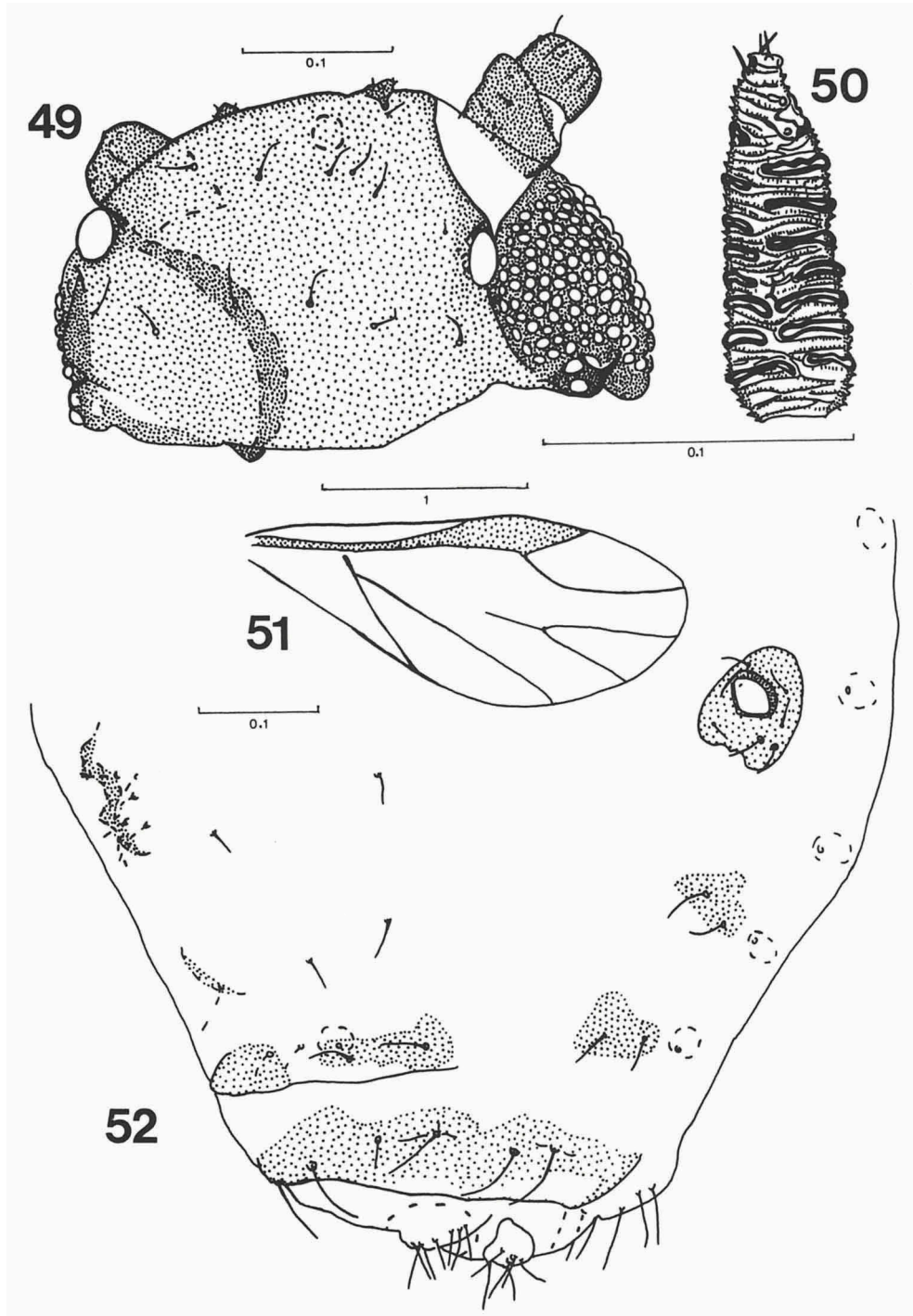

Fig. 48. *Astegopteryx minuta* (Van der Goot), apterous viviparous ♀, dorsal side.



Figs. 49-52. *Astegopteryx minuta* (Van der Goot), alate viviparous ♀. Fig. 49, dorsal side of the head. Fig. 50, antennal segment V, dorsal side. Fig. 51, fore wing. Fig. 52, dorsal sides of abdominal segments V-VIII.

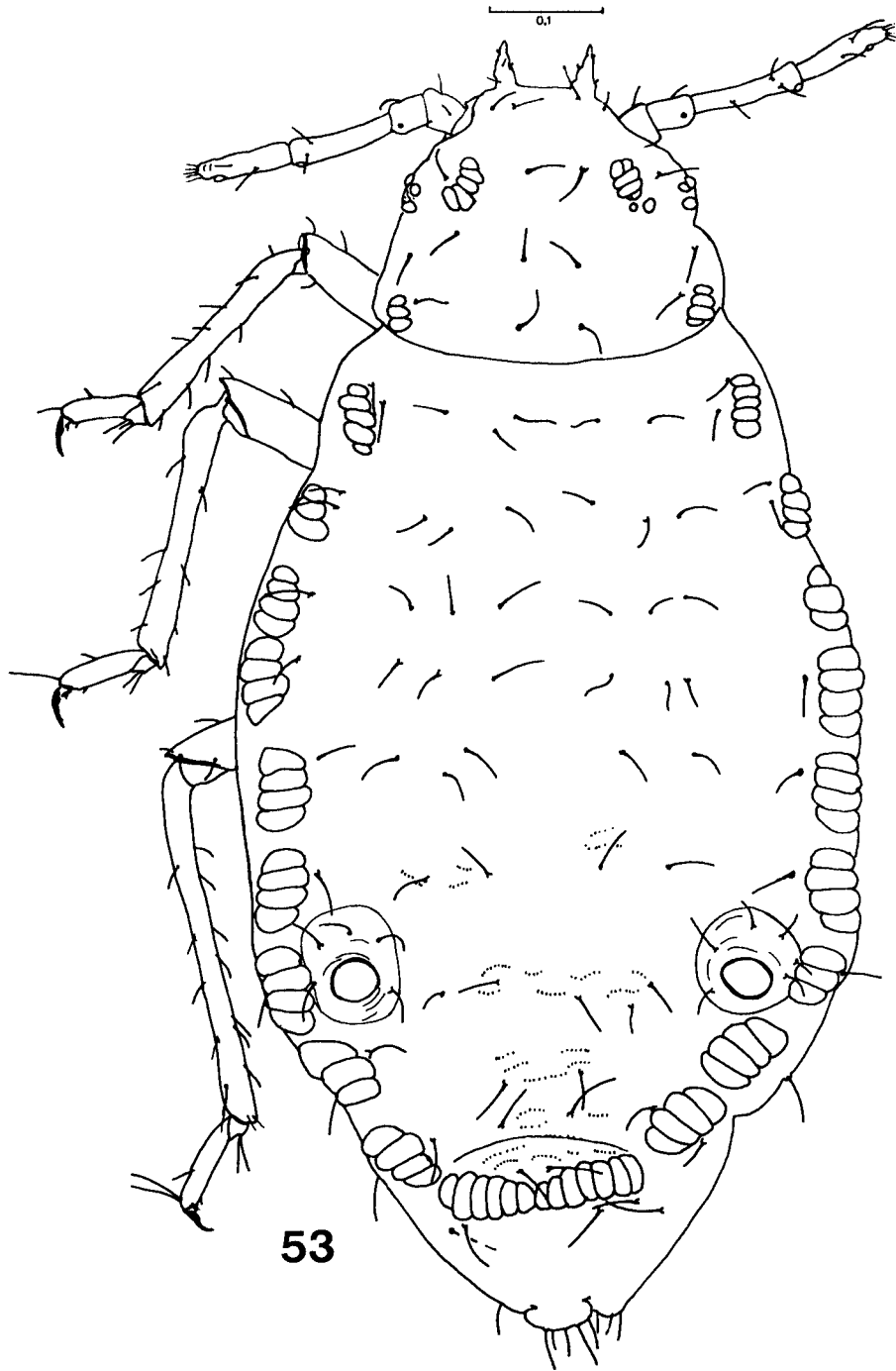
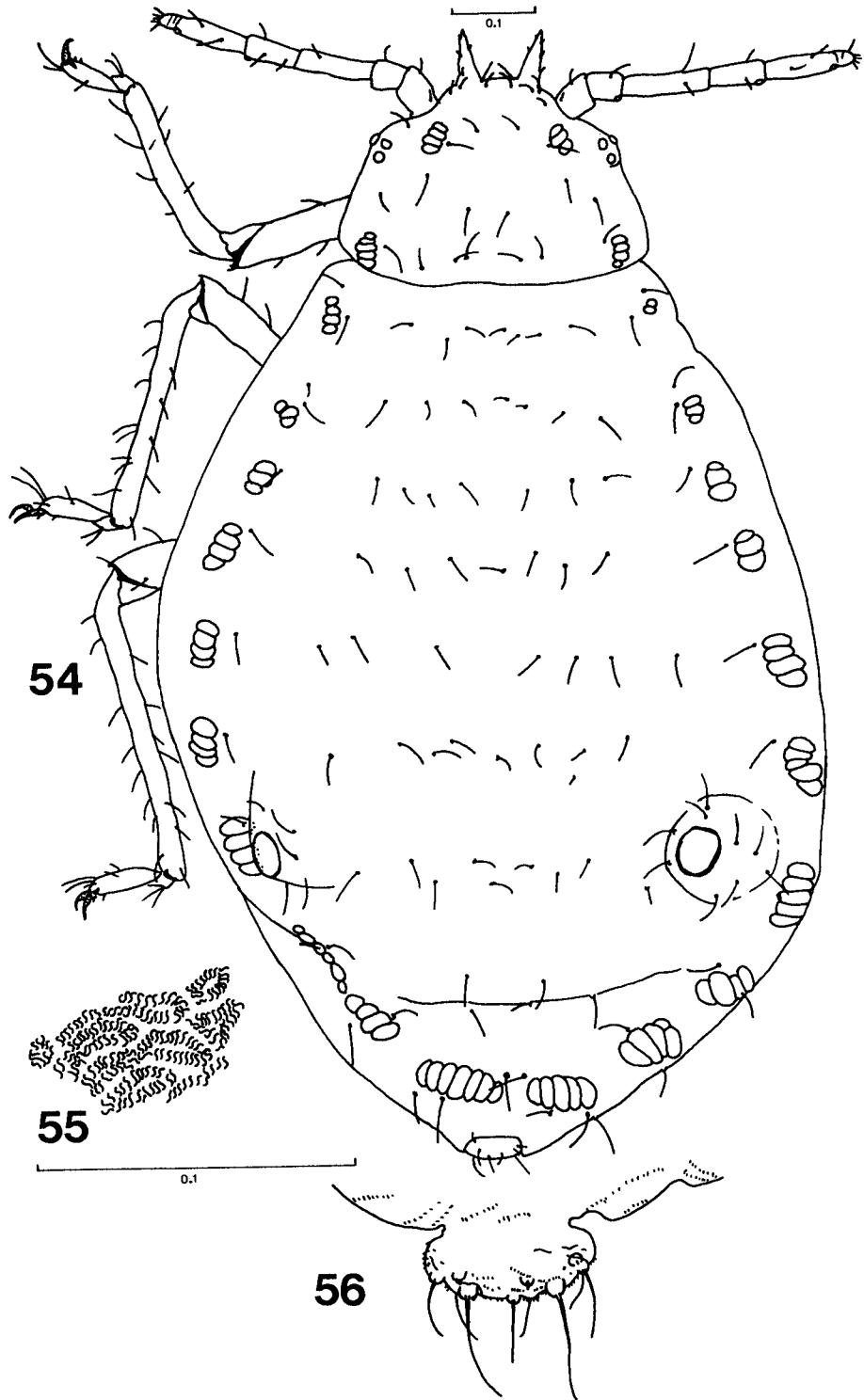
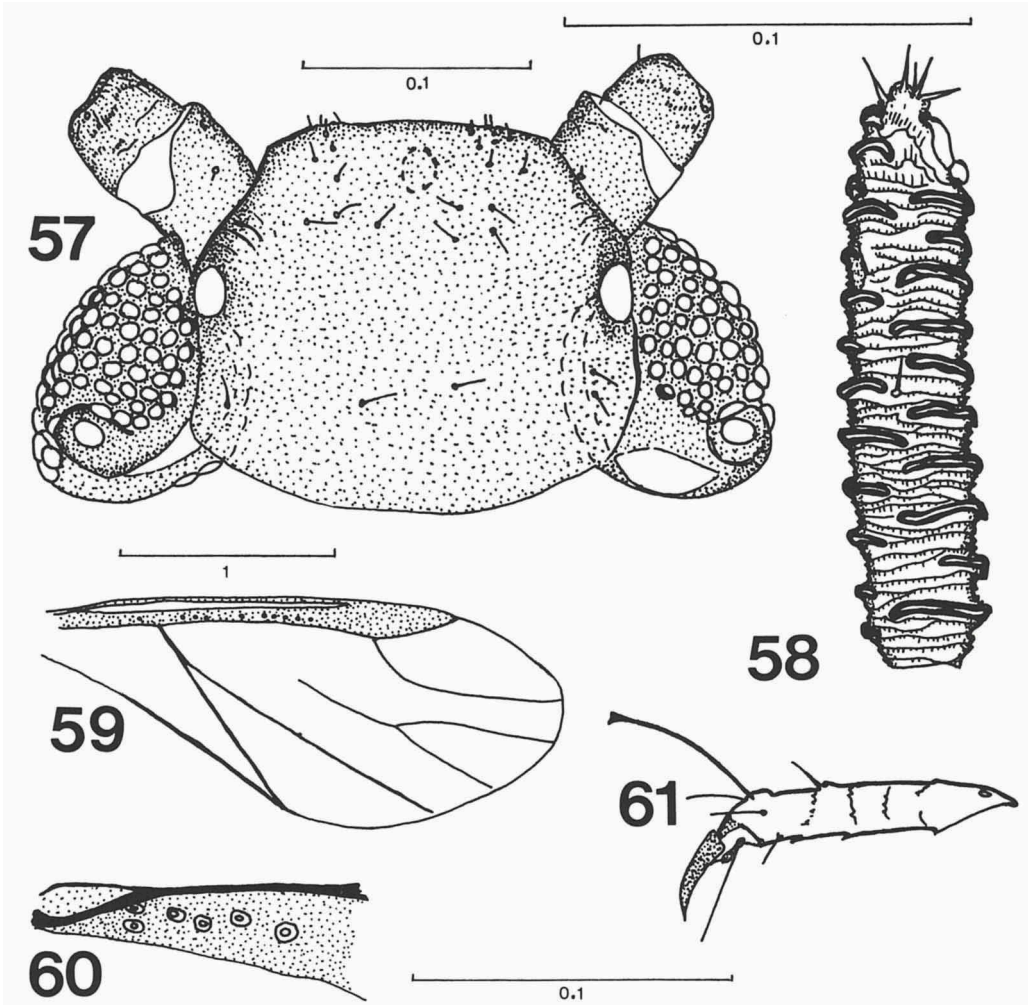

Fig. 53. *Astegopteryx muiri* (Van der Goot), apterous viviparous ♀, dorsal side.



Figs. 54-56. *Astegopteryx muiri* (Van der Goot), apterous viviparous ♀. Fig. 54, dorsal side of the body. Fig. 55, s-shaped wax glands marginally on abdominal segment III. Fig. 56, cauda.



Figs. 57-61. *Astegopteryx muii* (Van der Goot), alate viviparous ♀. Fig. 57, dorsal side of the head. Fig. 58, antennal segment V, dorsal side. Fig. 59, fore wing. Fig. 60, basal part of the fore wing. Fig. 61, second tarsal segment of the hind leg. Scale line below to figs. 60-61.

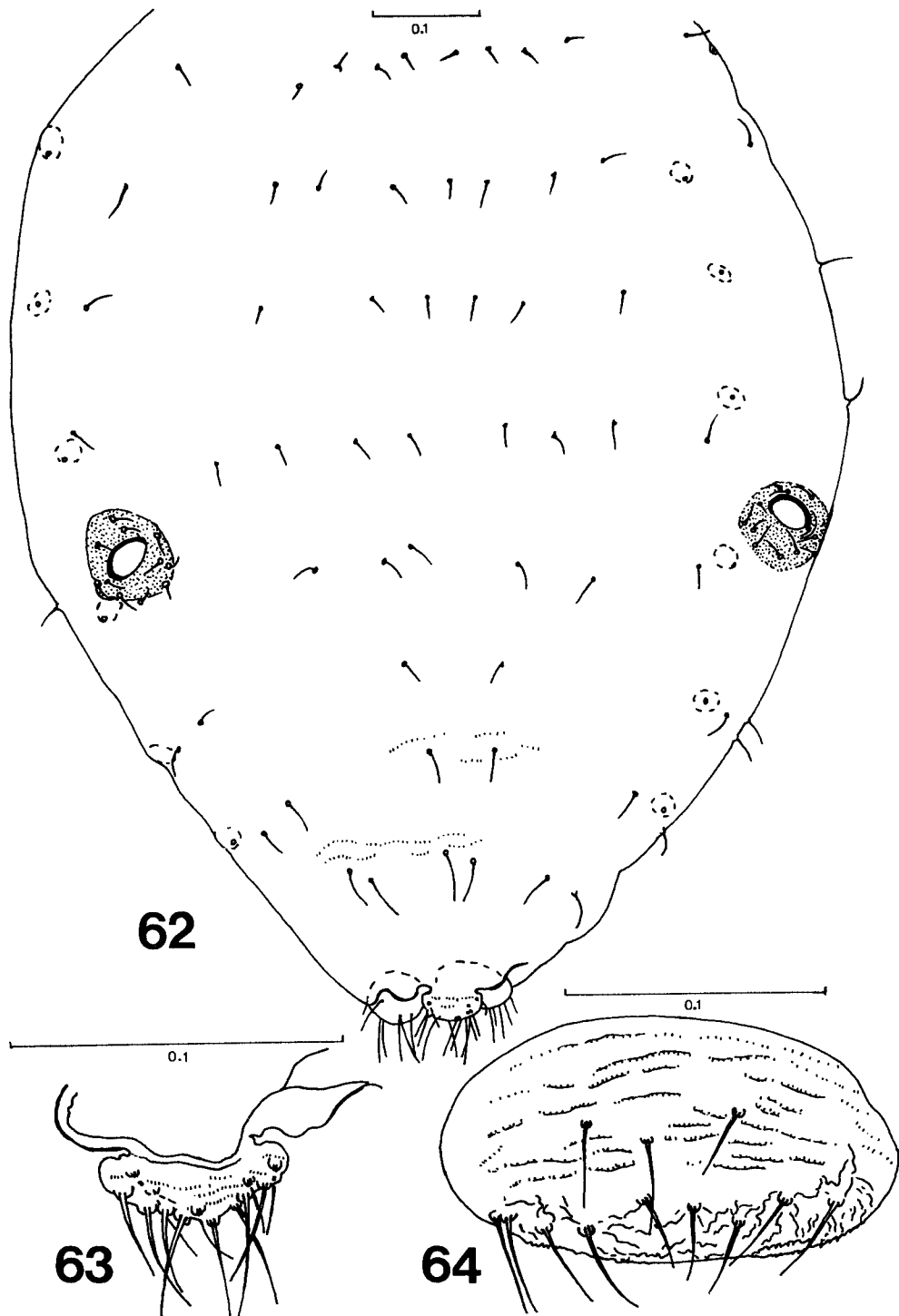

Figs. 62-64. *Astegopteryx muiroi* (Van der Goot), alate viviparous ♀. Fig. 62, dorsal sides of abdominal segments I-VIII. Fig. 63, cauda. Fig. 64, genital plate.



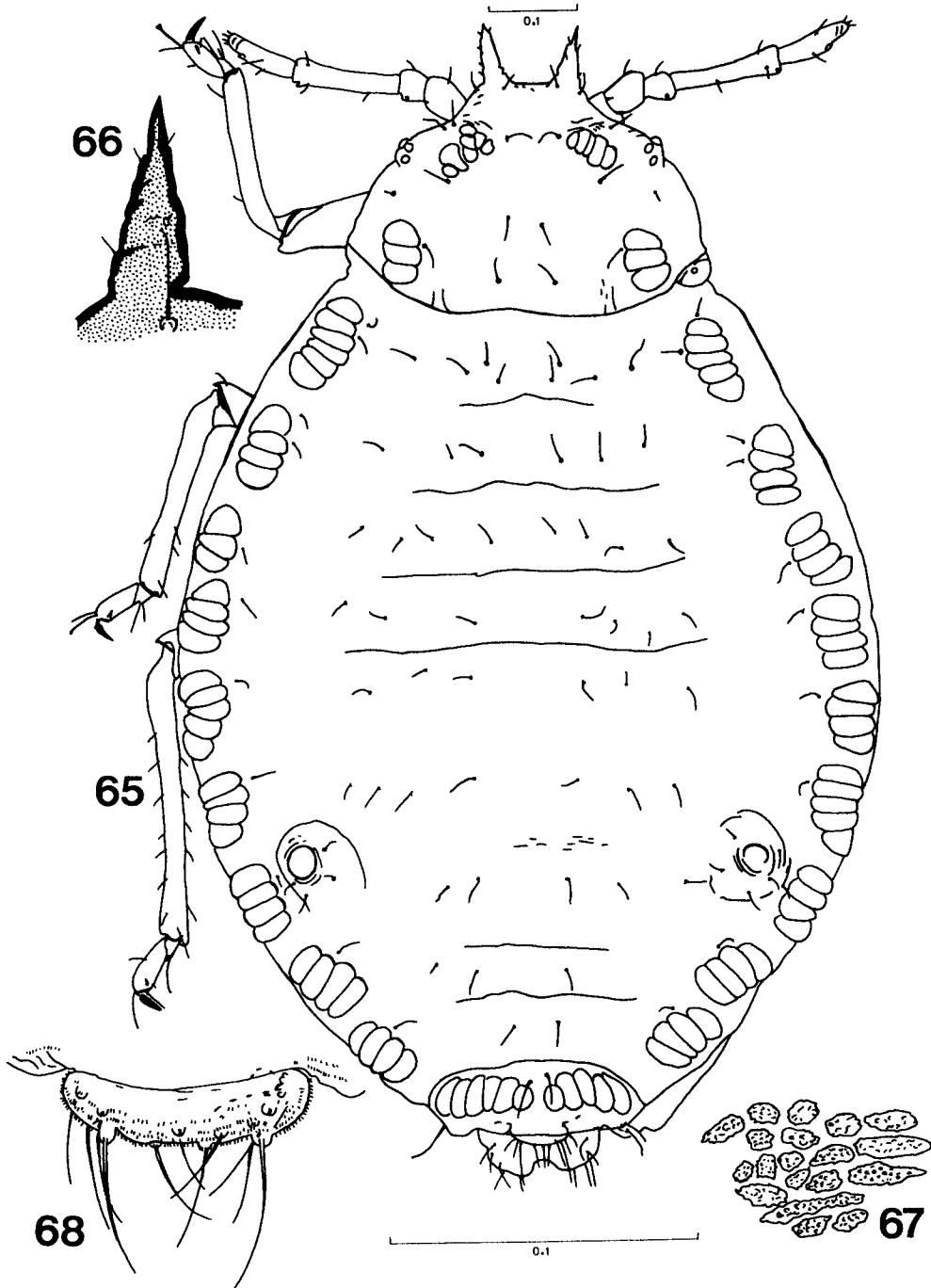

Figs. 65-68. *Astegopteryx nipae* (Van der Goot), apterous viviparous ♀. Fig. 65, body, dorsal side. Fig. 66, horn. Fig. 67, medial wax glands of abdominal segment III. Fig. 68, cauda. Scale line below to figs. 66 and 67-68.

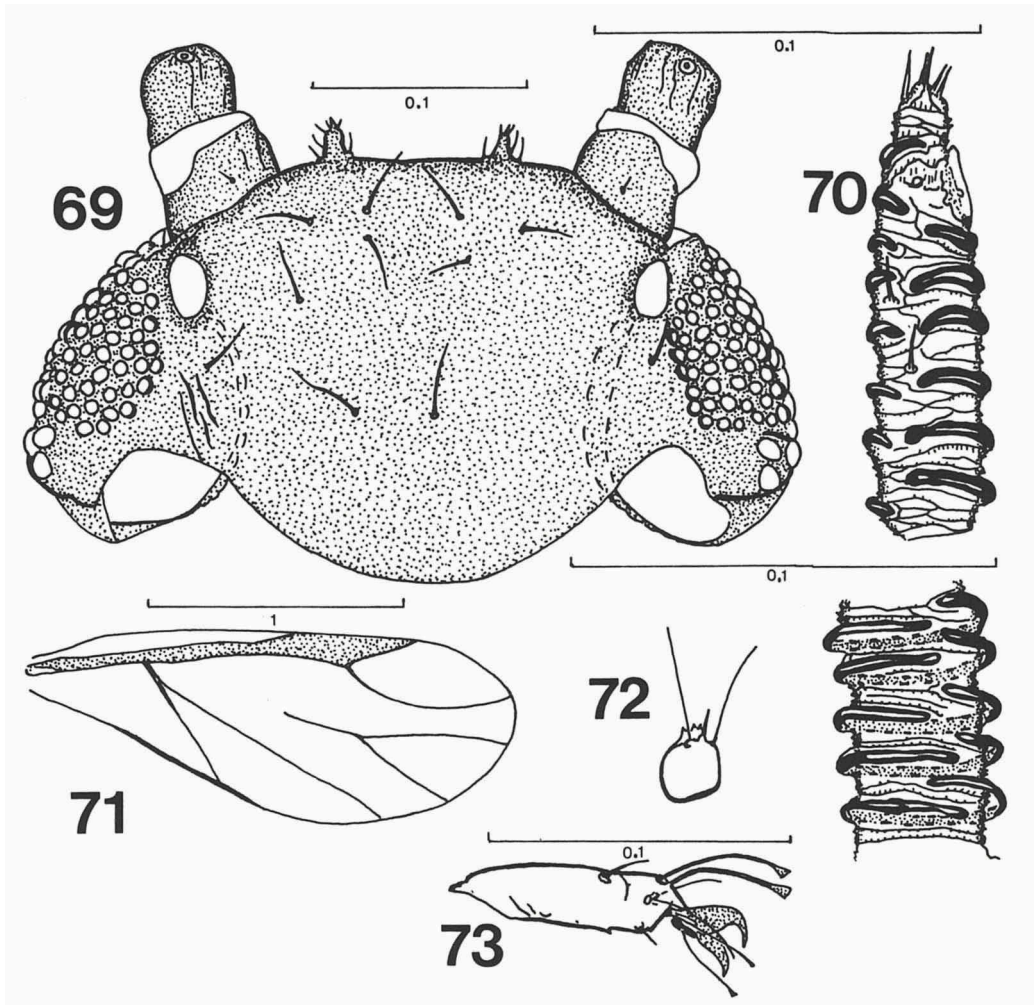

Figs. 69-73. *Astegopteryx nipae* (Van der Goot), alate viviparous ♀. Fig. 69, dorsal side of the head. Fig. 70, dorsal sides of antennal segments V (above), and III (below). Fig. 71, fore wing. Fig. 72, first tarsal segment of the foreleg. Fig. 73, second tarsal segment of the hind leg. Scale line 0.1 in the middle to antennal segment III, the 0.1 line below to figs. 72-73.

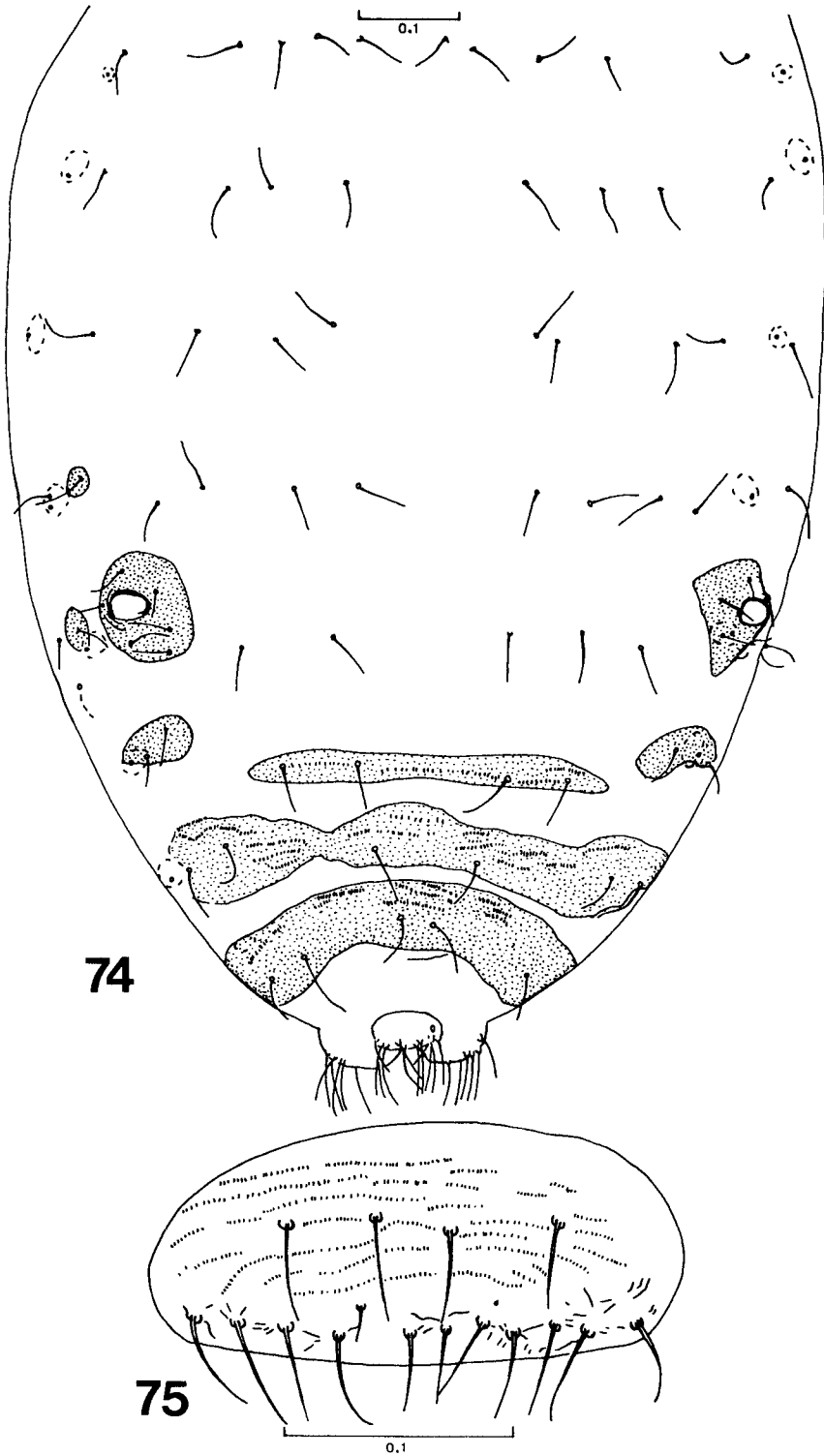

Figs. 74-75. *Astegopteryx nipae* (Van der Goot), alate viviparous ♀. Fig. 74, dorsal sides of abdominal segments I-VIII. Fig. 75, subgenital plate.

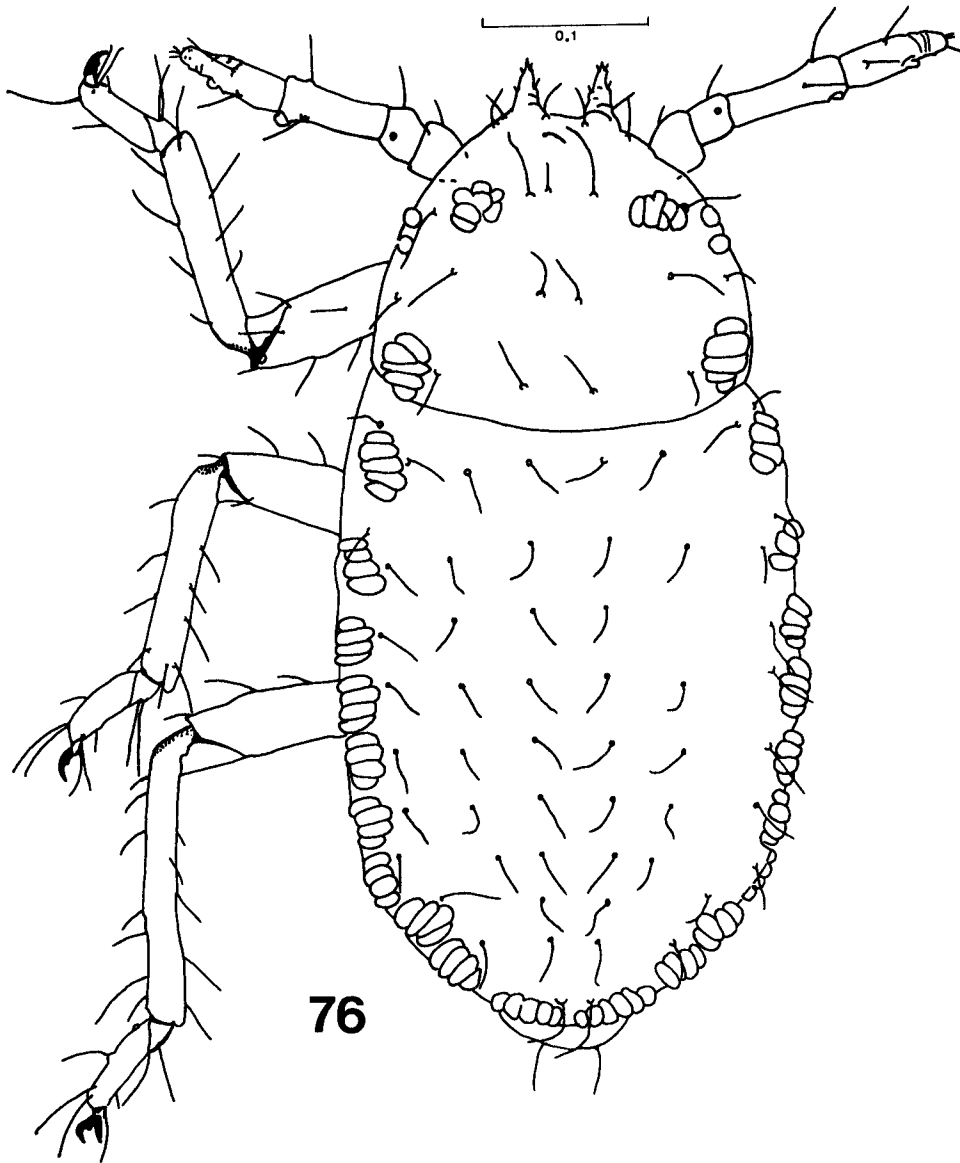
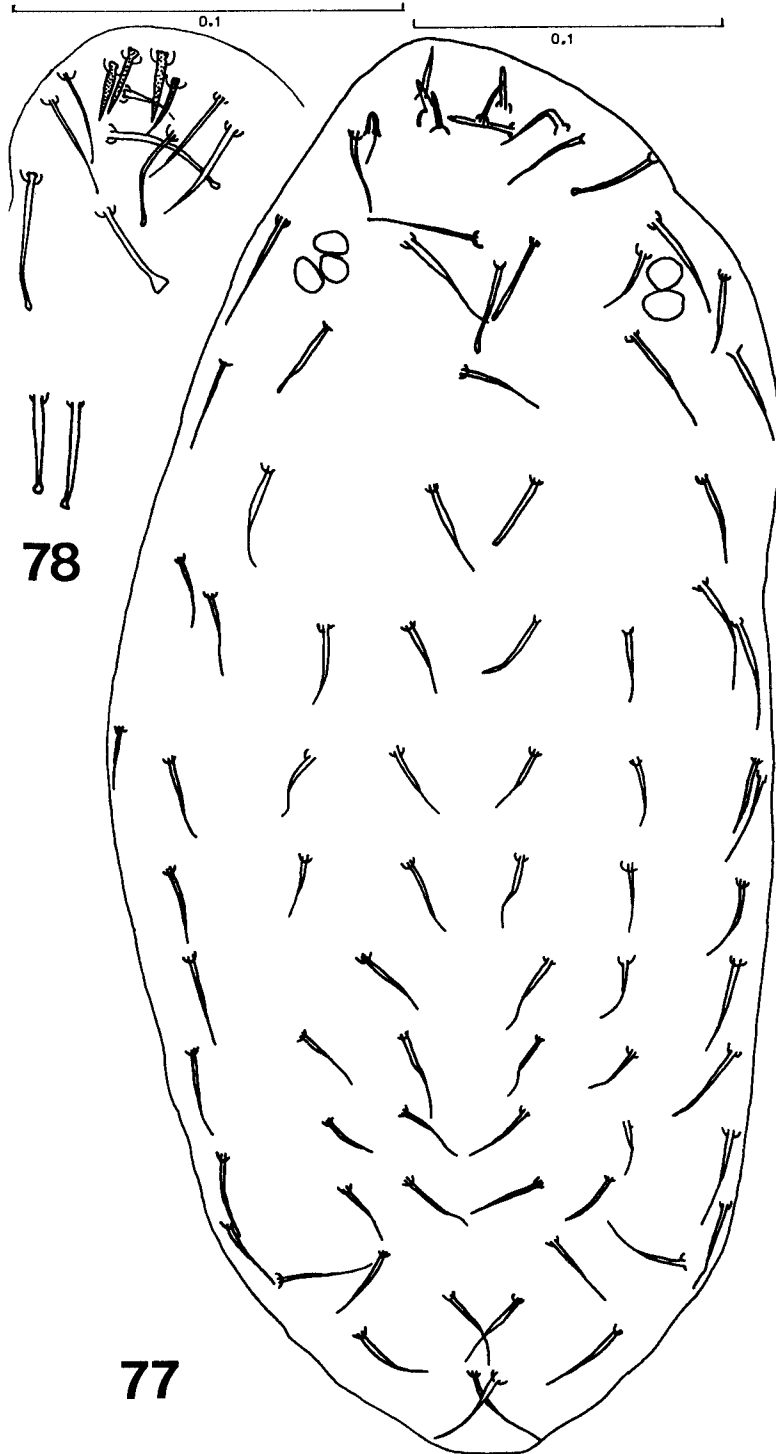

Fig. 76. *Astegopteryx nipae* (Van der Goot), first stage larva of apterous viviparous ♀.



Figs. 77-78. *Astegopteryx nipae* (Van der Goot), embryo inside alate viviparous ♀. Fig. 77, dorsal side of the body. Fig. 78, part of the head and two separate hairs. Scale line right on top to fig. 77, and to the two separate hairs of fig. 78.

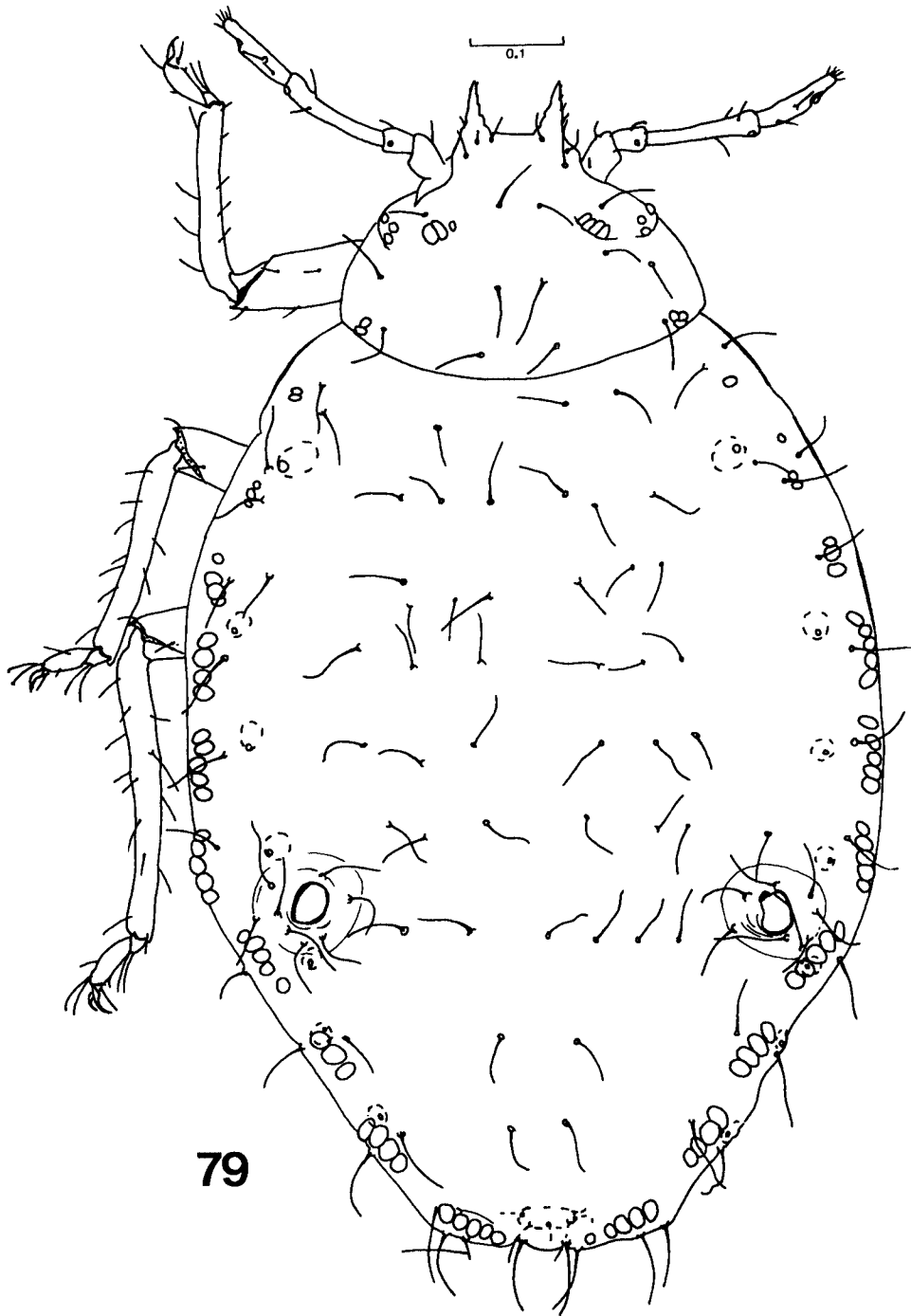
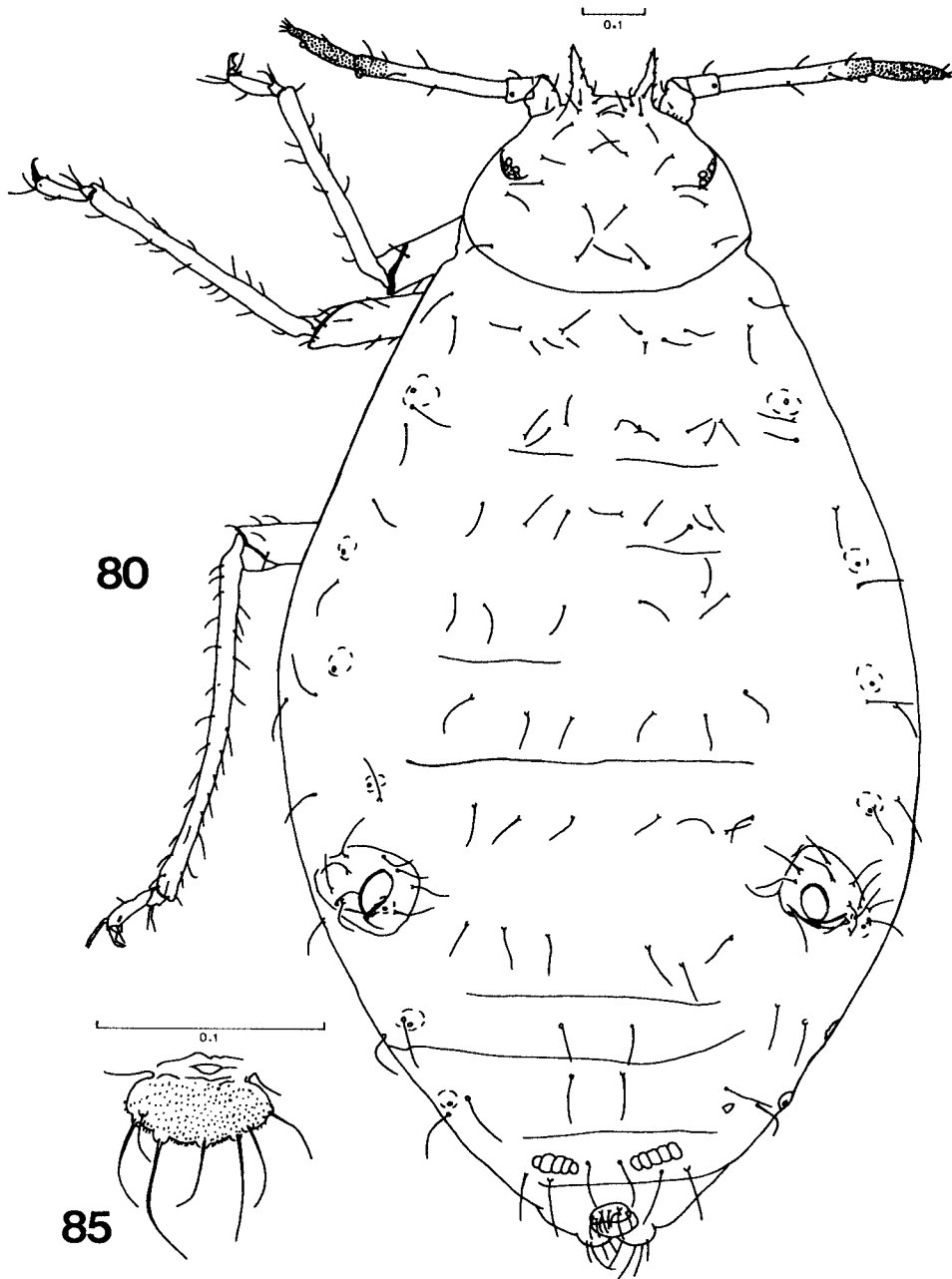
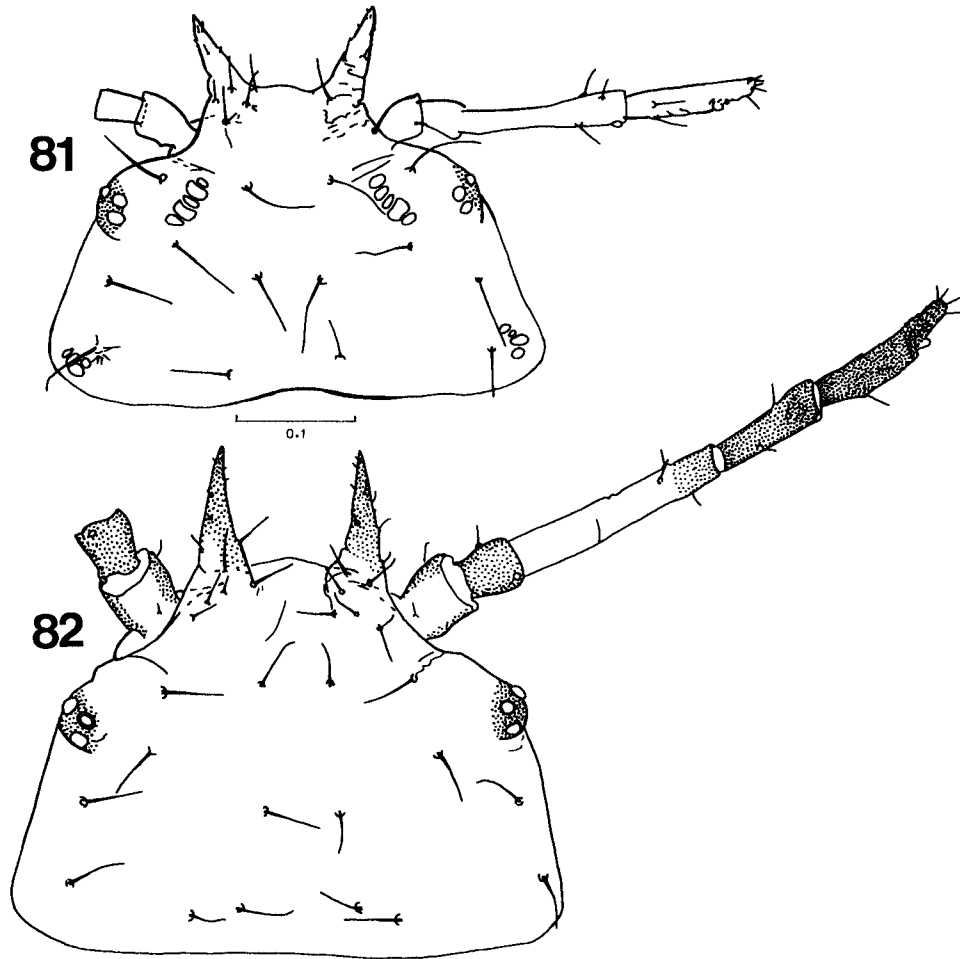

Fig. 79. *Astegopteryx pallida* (Van der Goot), apterous viviparous ♀, dorsal side of the body.



Figs. 80, 85. *Astegopteryx pallida* (Van der Goot), apterous viviparous ♀. Fig. 80, dorsal side of the body. Fig. 85, cauda.



Figs. 81-82. *Astegopteryx pallida* (Van der Goot), apterous viviparous ♀♀, dorsal sides of the heads.



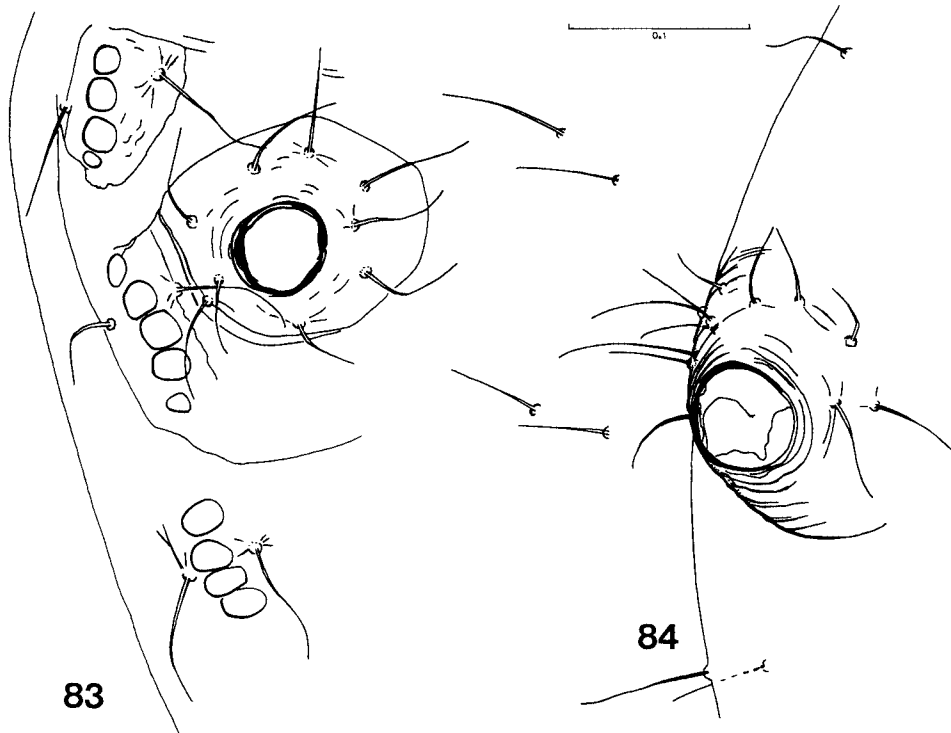

Figs. 83-84. *Astegopteryx pallida* (Van der Goot), apterous viviparous ♀♀, marginal parts of abdominal segments IV-VI.

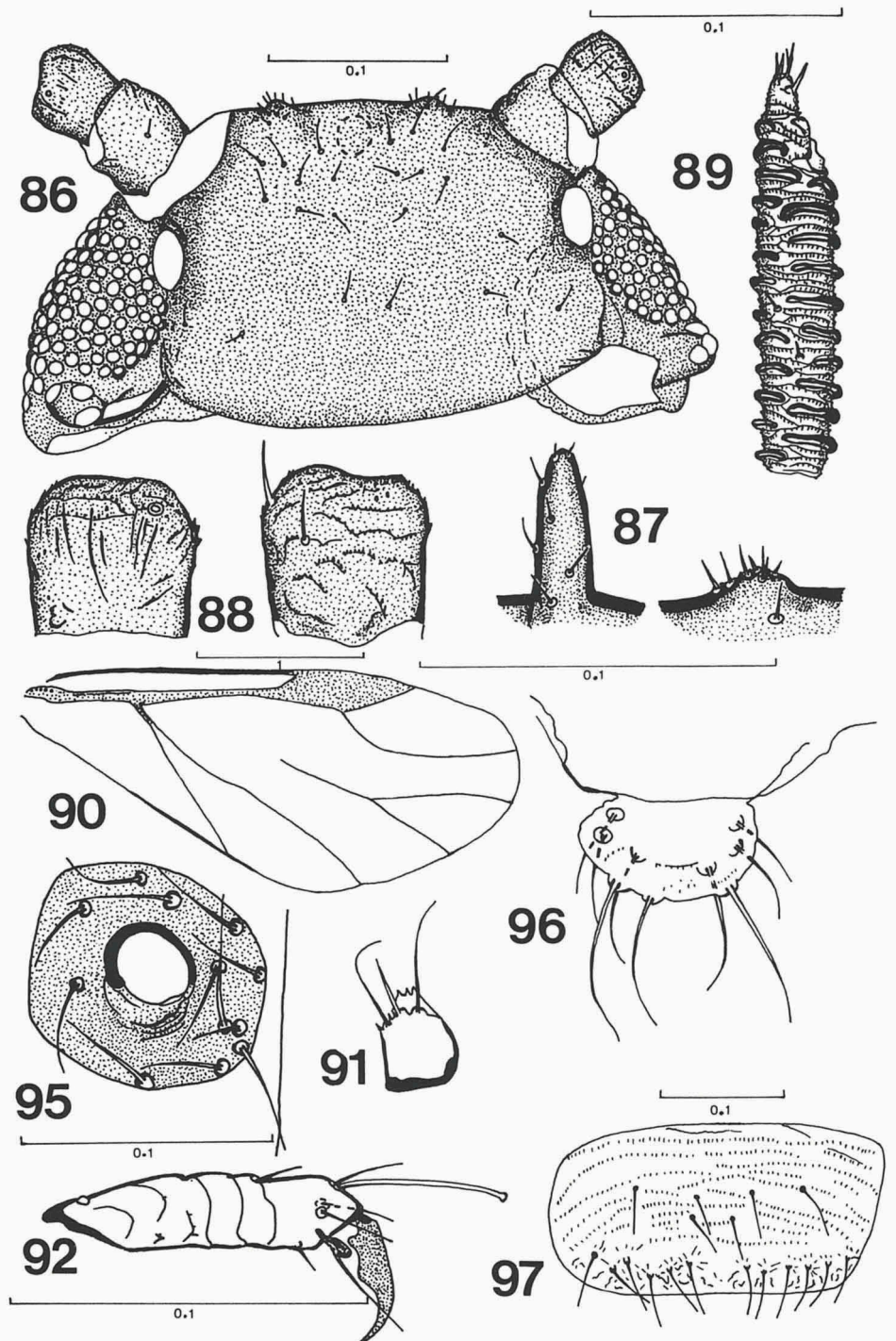

Figs. 86-92, 95-97. *Astegopteryx pallida* (Van der Goot), alate viviparous ♀. Fig. 86, dorsal side of the head. Fig. 87, horns. Fig. 88, antennal segment II. Fig. 89, antennal segment V, dorsal side. Fig. 90, fore wing. Fig. 91, first tarsal segment of the foreleg. Fig. 92, second tarsal segment of the hind leg. Fig. 95, siphunculus. Fig. 96, cauda. Fig. 97, subgenital plate. Scale lines 0.1 close to figs. 87 and 92 apply also to figs. 88, 91 and 96.

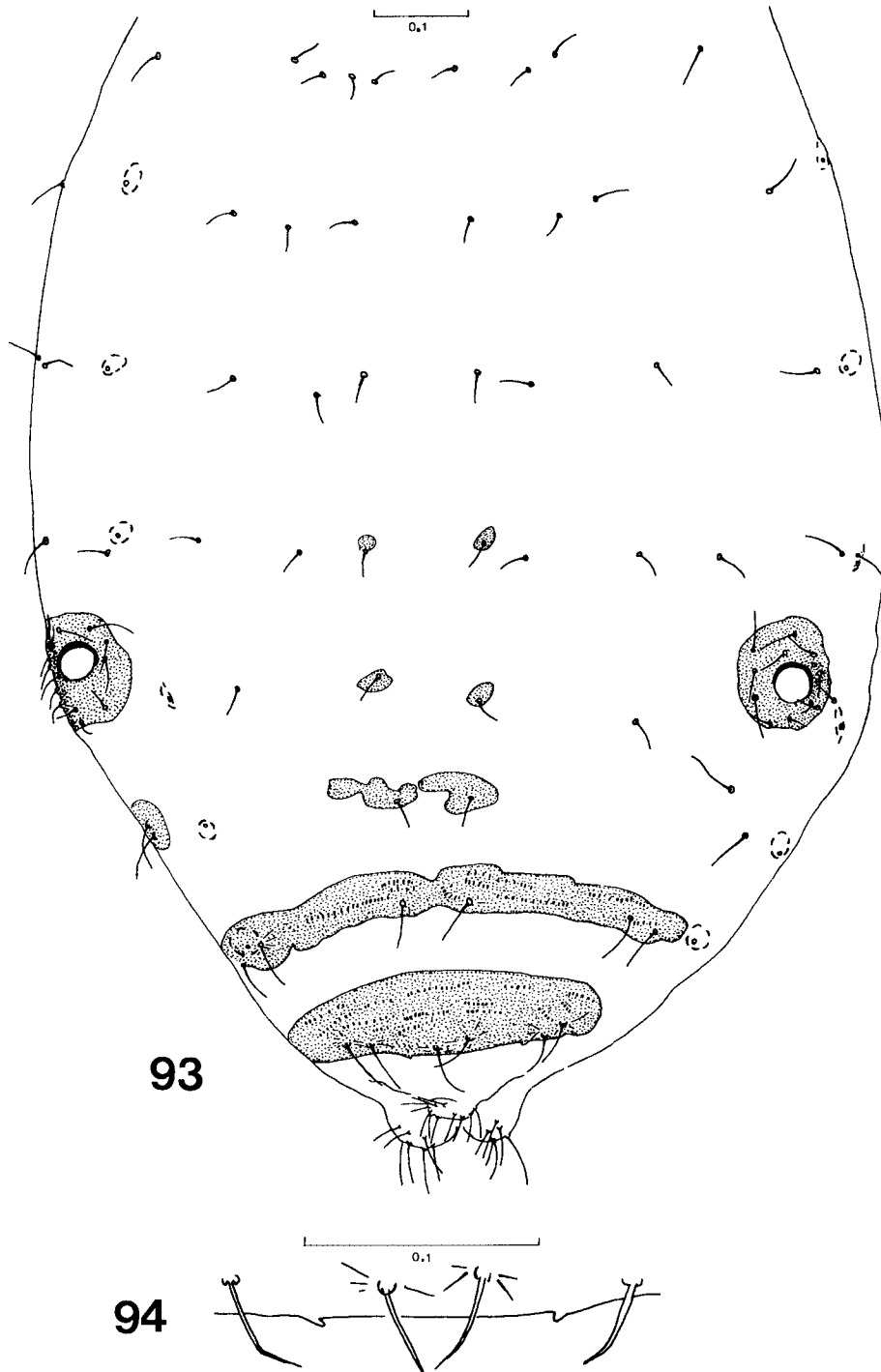

Figs. 93-94. *Astegopteryx pallida* (Van der Goot), alate viviparous ♀. Fig. 93, dorsal side of abdominal segments I-VIII. Fig. 94, middle part of abdominal segment VIII.

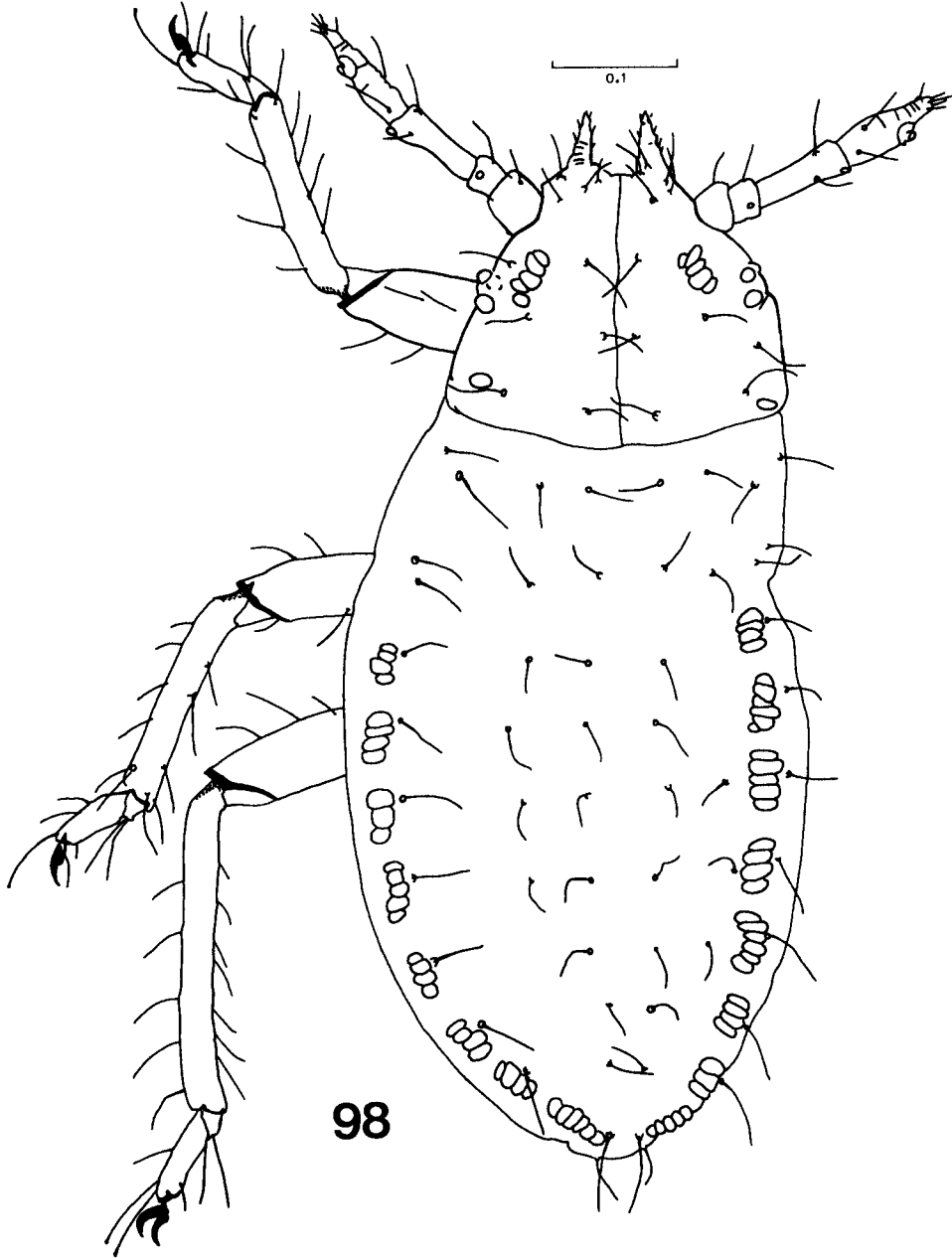

Fig. 98. *Astegopteryx pallida* (Van der Goot), first stage larva, normal.

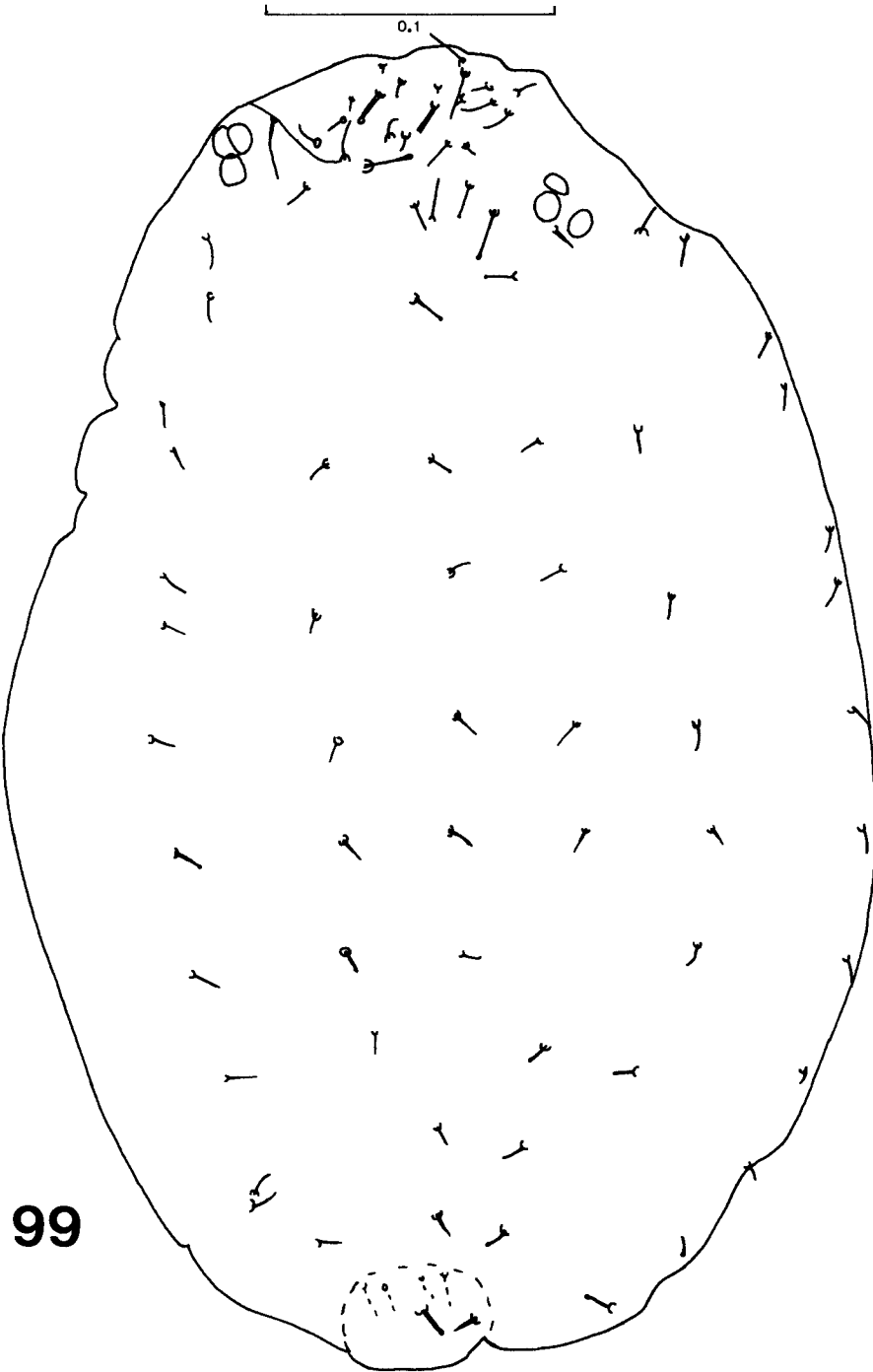
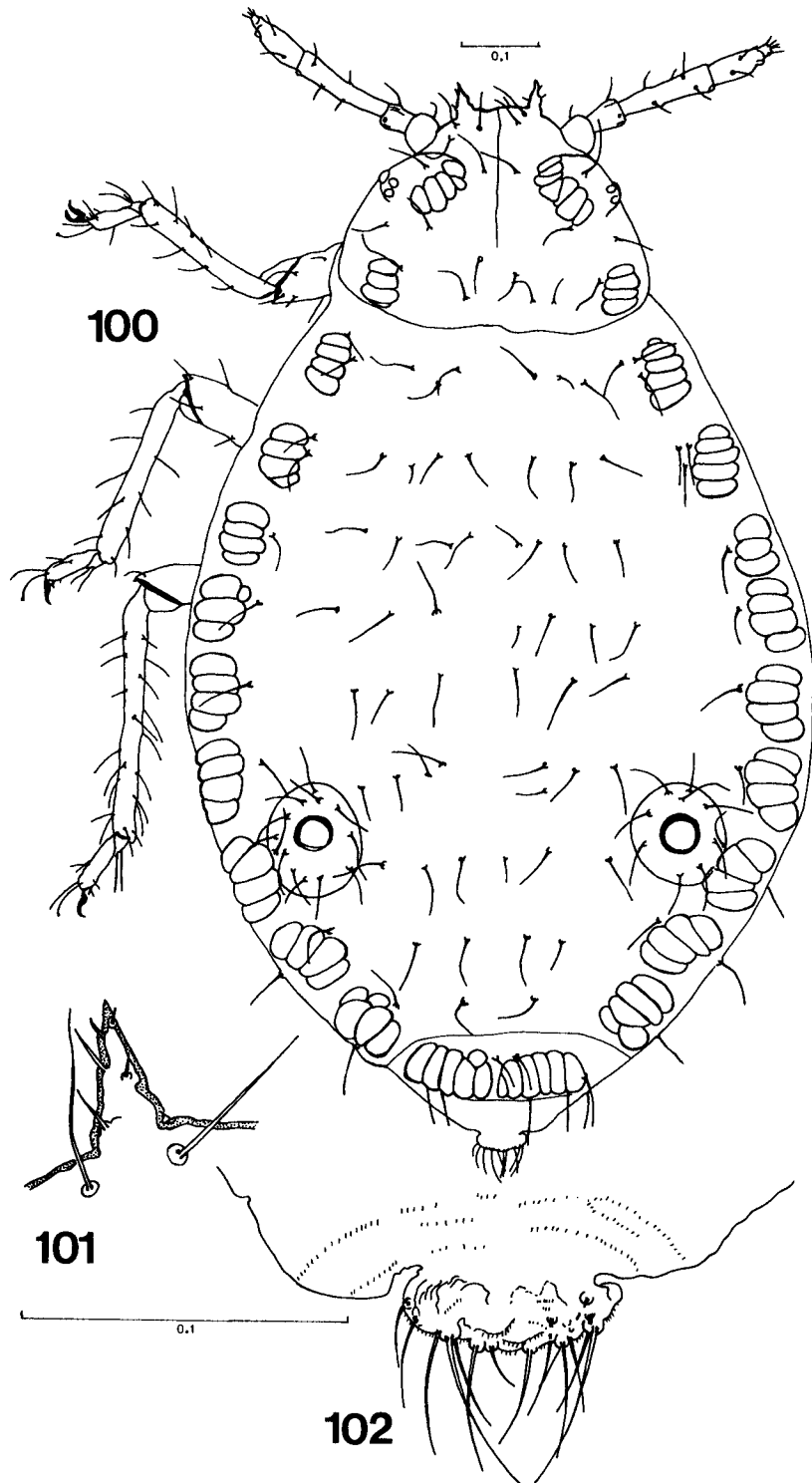
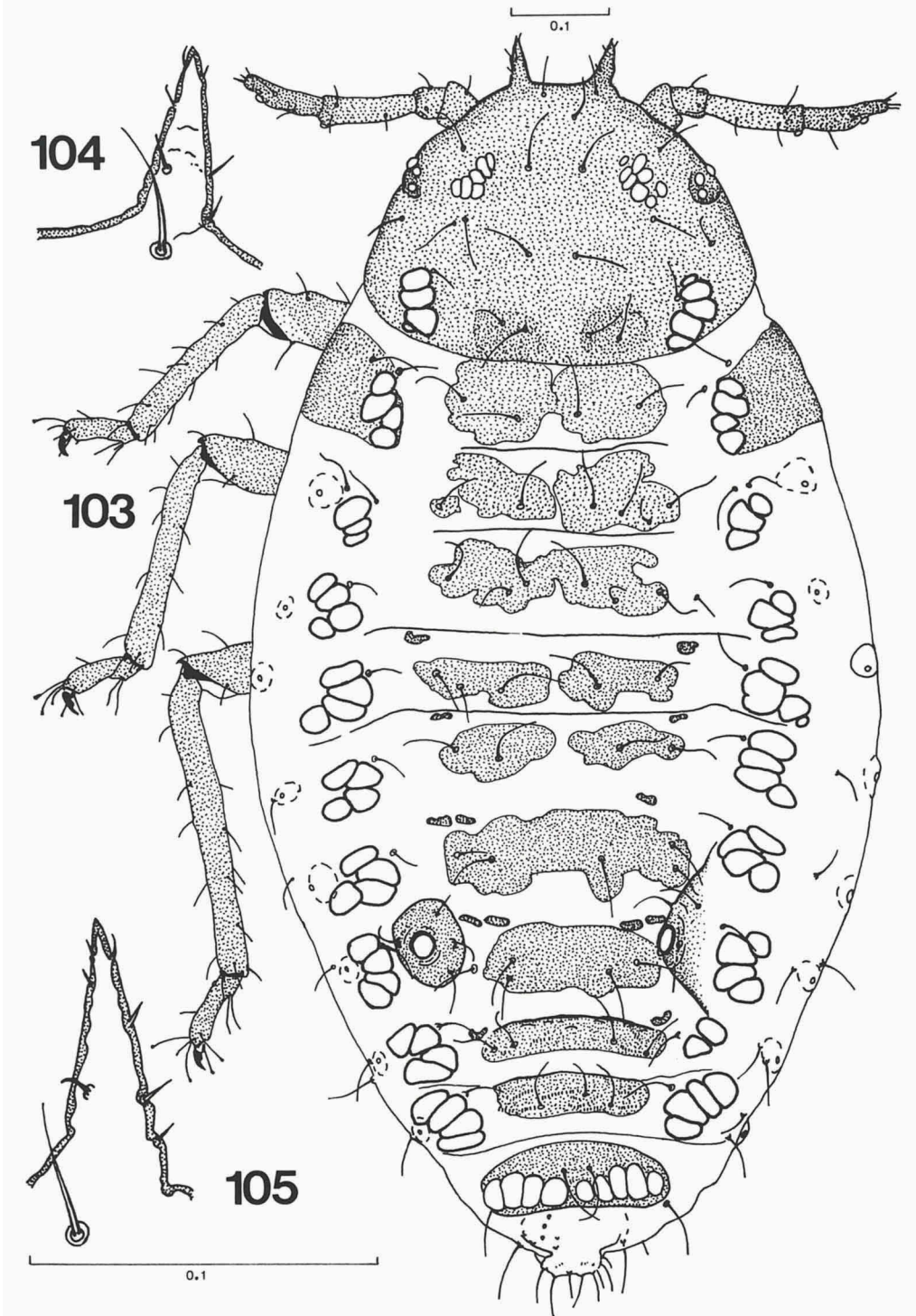

Fig. 99. *Astegopteryx pallida* (Van der Goot), embryo inside alate viviparous ♀, dorsal side.



Figs. 100-102. *Astegopteryx pandani* (Takahashi), apterous viviparous ♀. Fig. 100, dorsal side of the body. Fig. 101, horn. Fig. 102, cauda.



Figs. 103-105. *Astegopteryx rappardi* Hille Ris Lambers, apterous viviparous ♀. Fig. 103, dorsal side of the body. Figs. 104-105, horns.

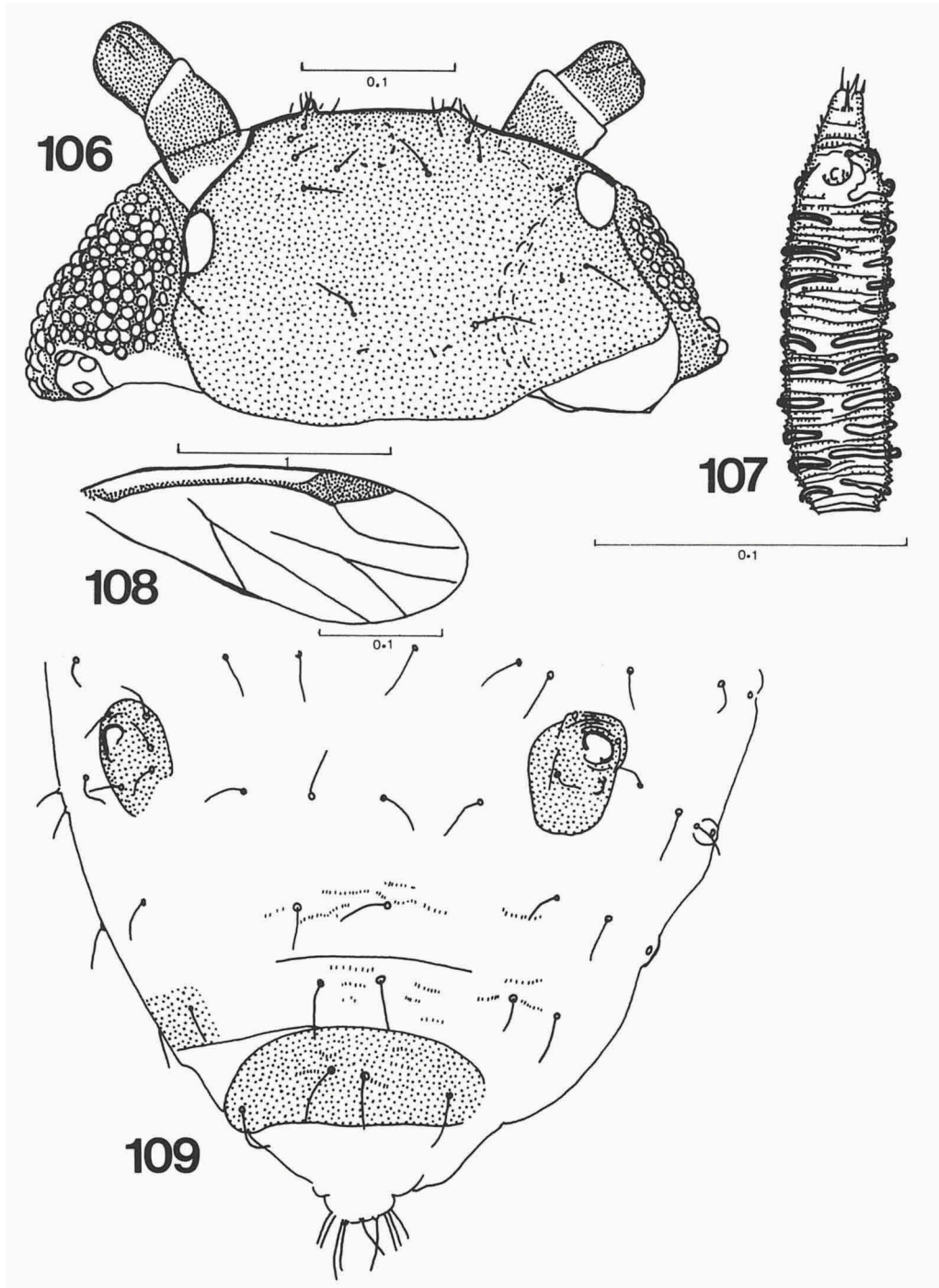

Figs. 106-109. *Astegopteryx rappardi* Hille Ris Lambers, alate viviparous ♀. Fig. 106, dorsal side of the head. Fig. 107, dorsal side of antennal segment V. Fig. 108, fore wing. Fig. 109, abdominal segments IV-VIII, dorsal sides.



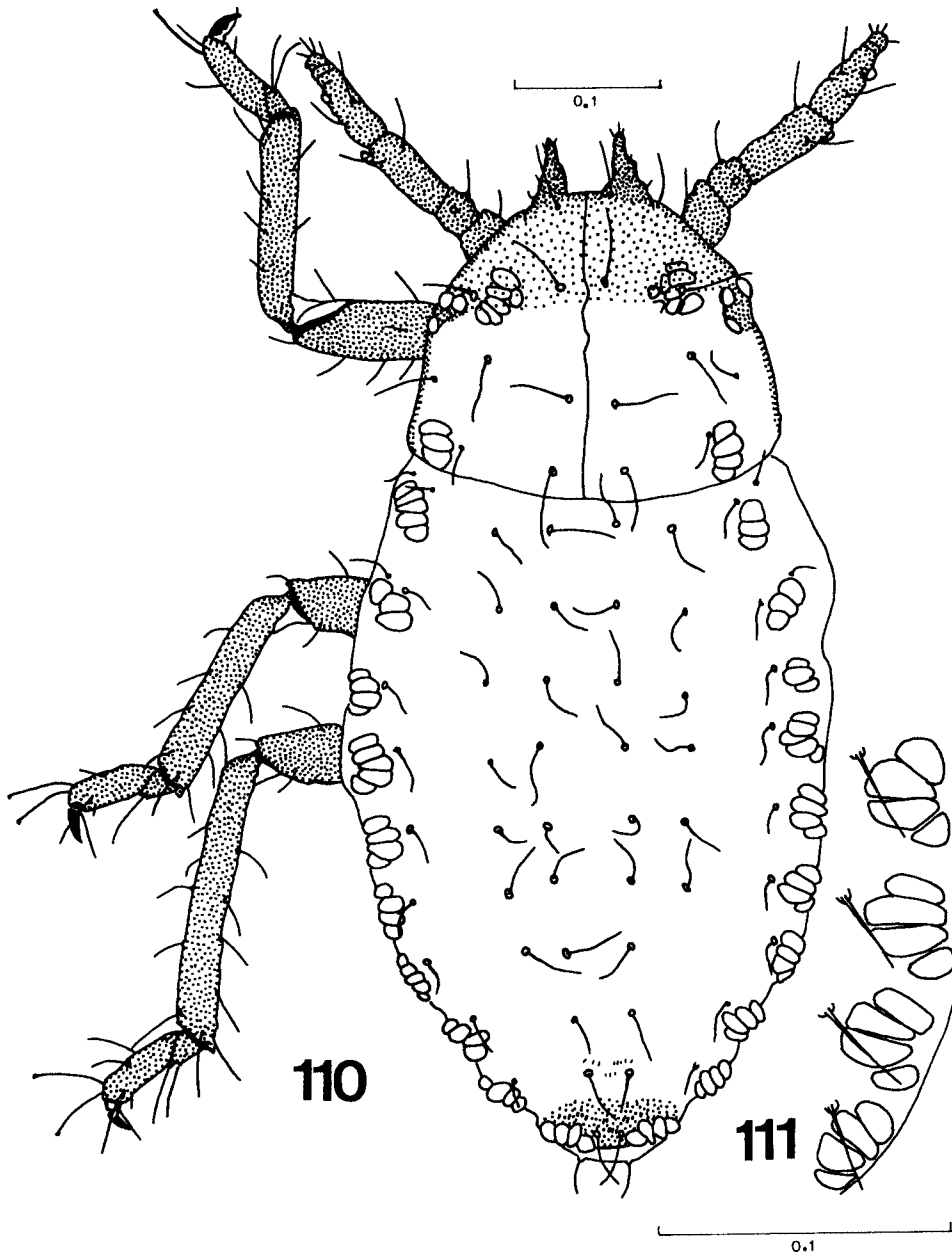

Figs. 110-111. *Astegopteryx rappardi* Hille Ris Lambers, first stage larva of apterous viviparous ♀, dorsal side. Fig. 111, marginal sides of abdominal segments II-V.

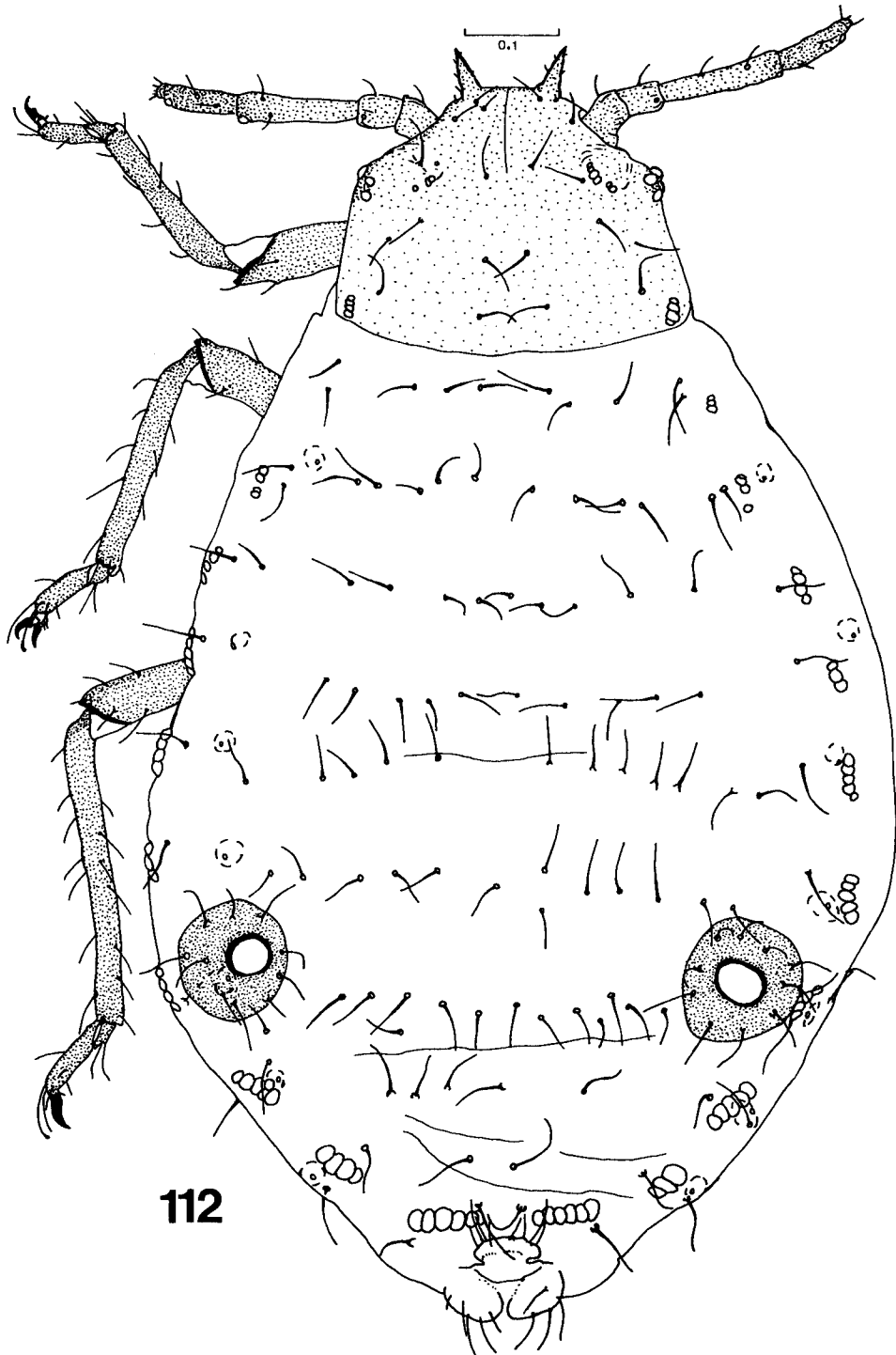

Fig. 112. *Astegopteryx rhapsidis* (Van der Goot), apterous viviparous ♀, dorsal side.

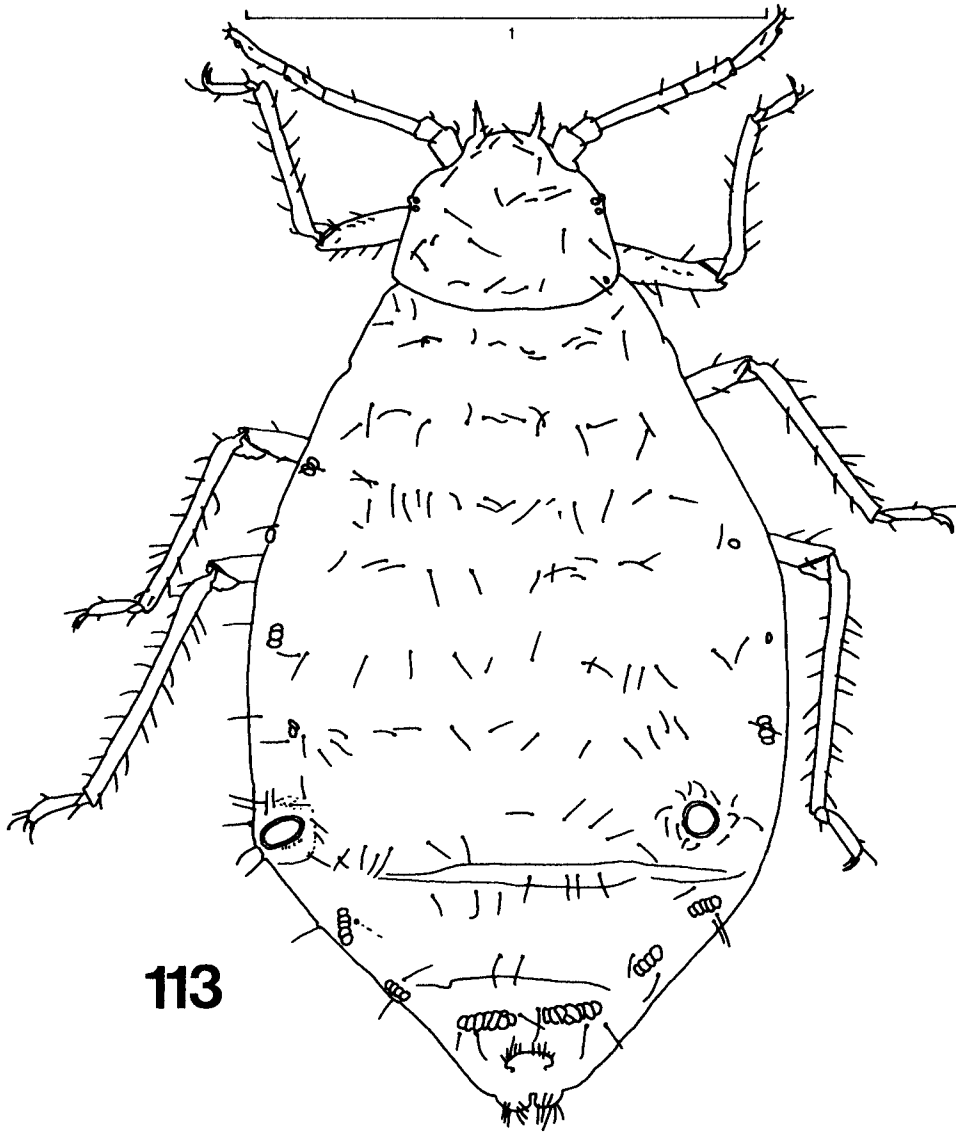
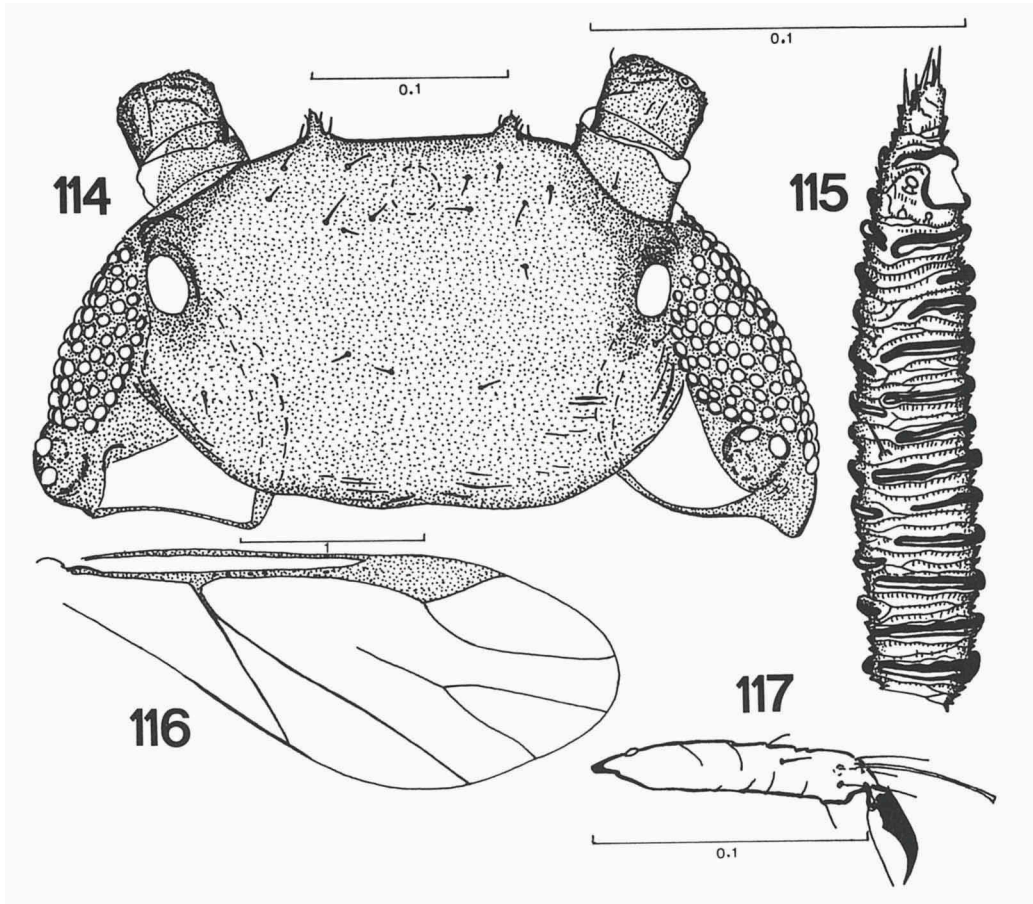
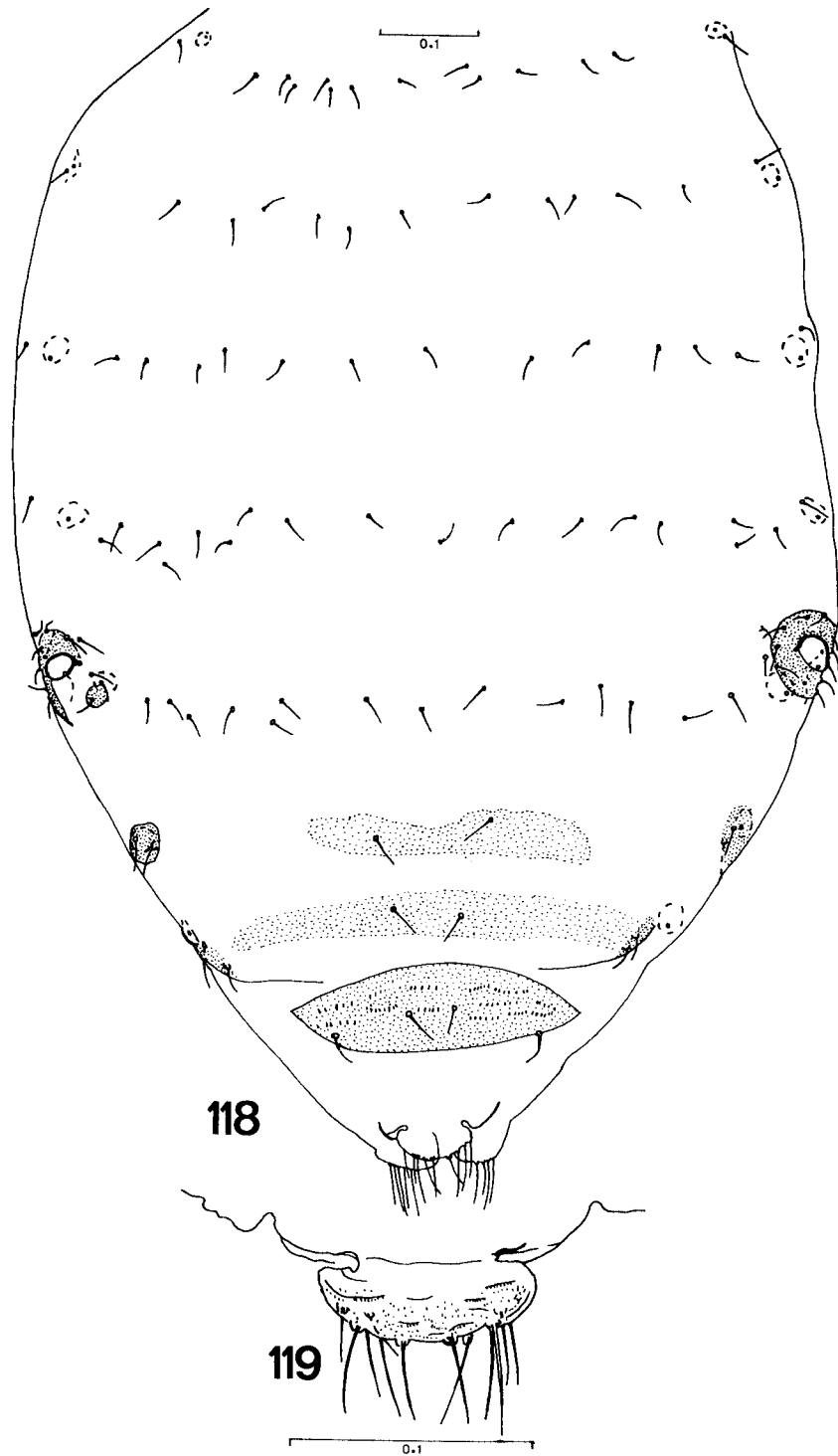

Fig. 113. *Astegopteryx rhapsidis* (Van der Goot), apterous viviparous ♀, dorsal side.



Figs. 114-117. *Astegopteryx rhapsidis* (Van der Goot), alate viviparous ♀. Fig. 114, dorsal side of the head. Fig. 115, dorsal side of antennal segment V. Fig. 116, fore wing. Fig. 117, second tarsal segment of the hind leg.



Figs. 118-119. *Astegopteryx rhapsidis* (Van der Goot), alate viviparous ♀. Fig. 118, dorsal sides of abdominal segments I-VIII. Fig. 119, cauda.



Fig. 120. *Astegopteryx rhapsidis* (Van der Goot), first stage larva, normal.

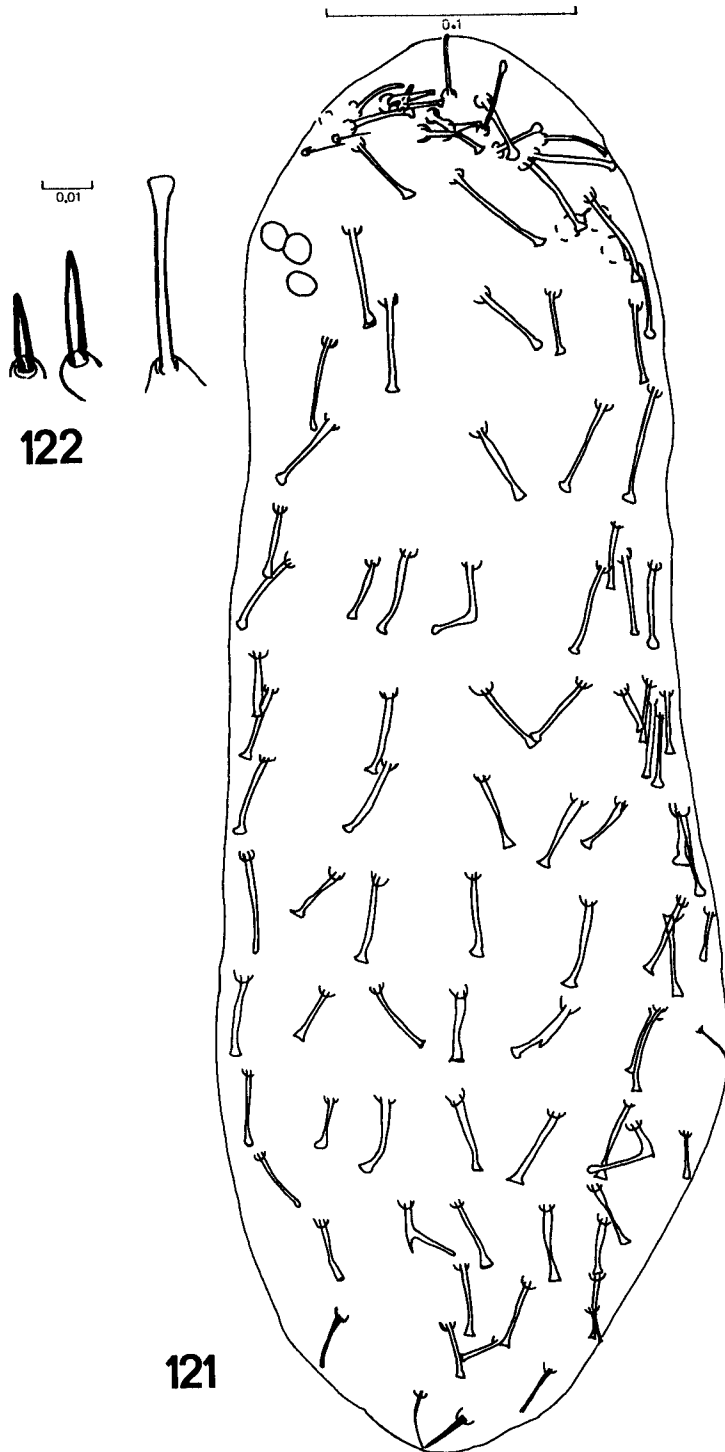

Figs. 121-122. *Astegopteryx rhapsidis* (Van der Goot), embryo inside alate viviparous ♀, dorsal side. Fig. 122, two spines ventrally on the head (left), and one dorsal hair (right).

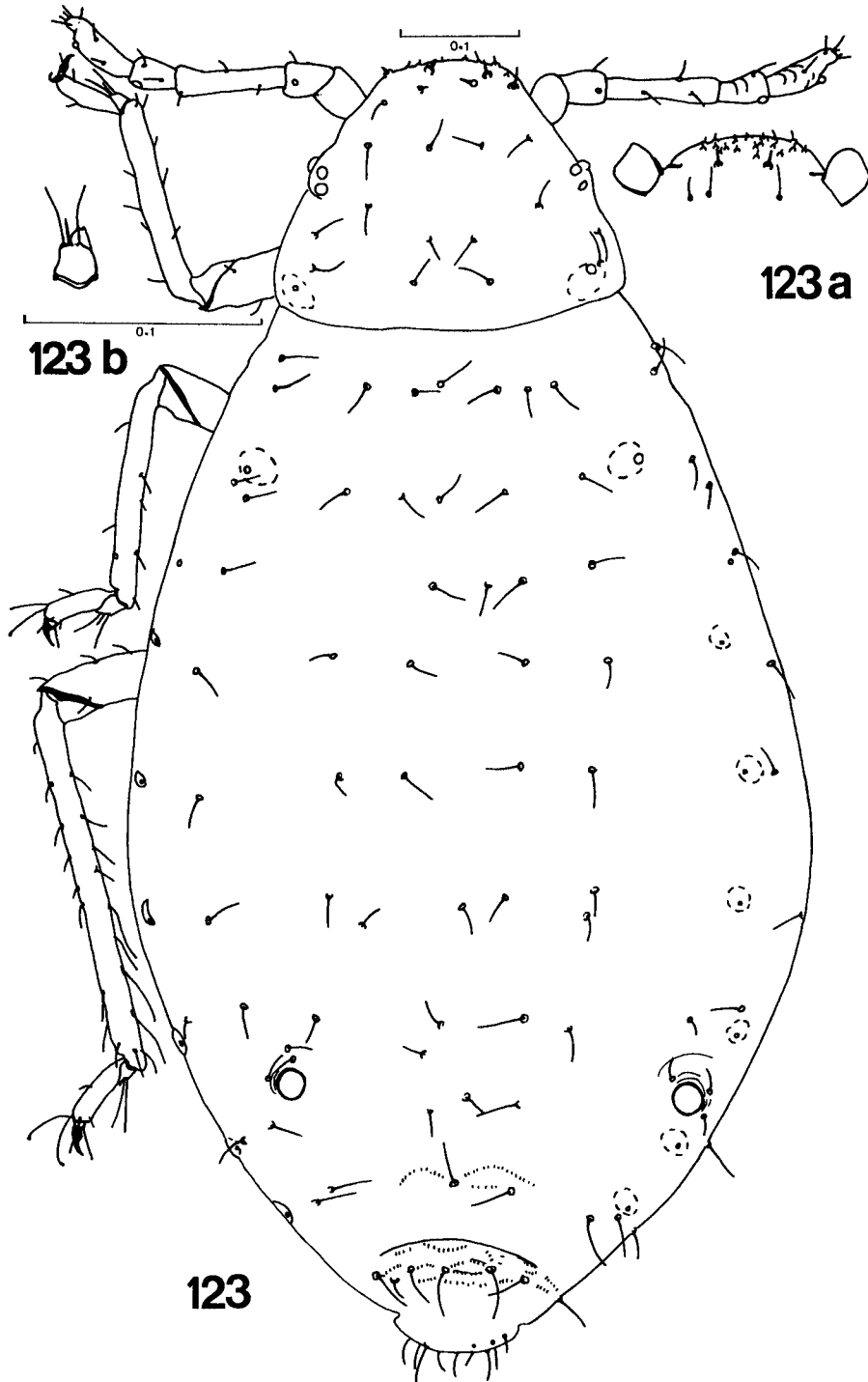

Figs. 123-123b. *Astegopteryx setigera* spec. nov., apterous viviparous ♀ from *Styrax* gall, dorsal side. Fig. 123a, ventral side of the frons. Fig. 123b, first tarsal segment of the foreleg.



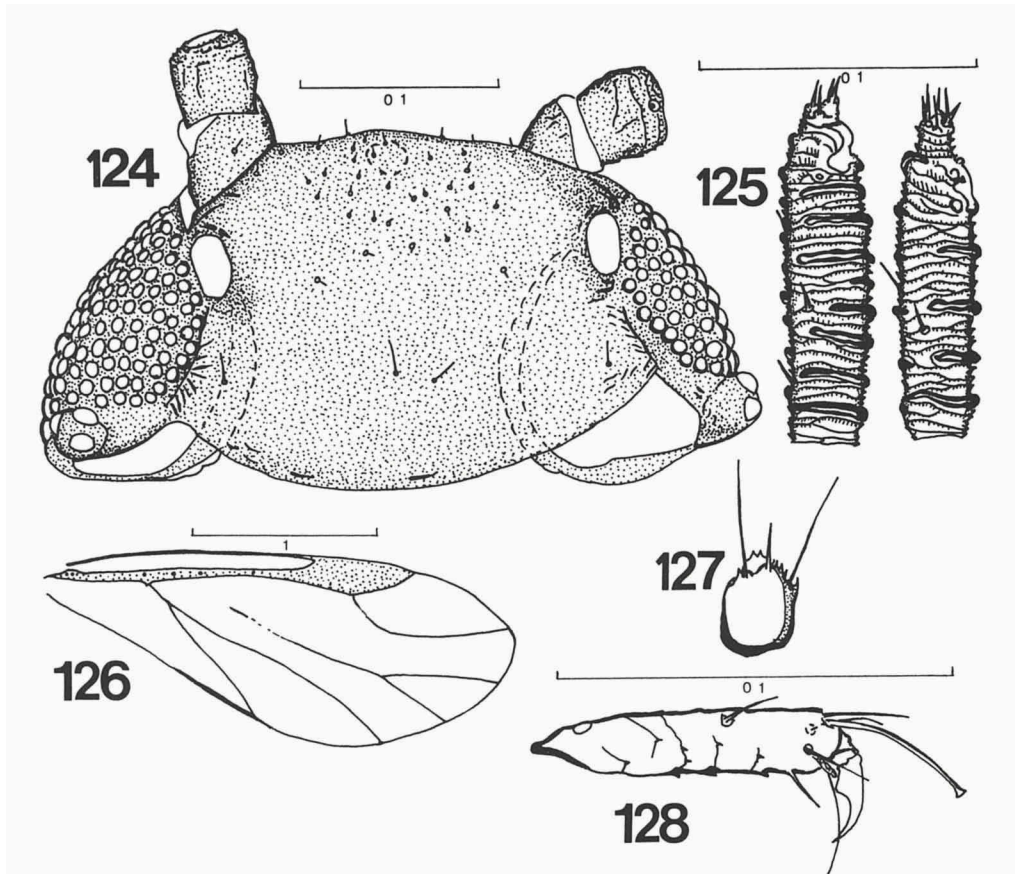

Figs. 124-128. *Astegopteryx setigera* spec. nov., alate viviparous ♀ from *Styrax* gall. Fig. 124, dorsal side of the head. Fig. 125, dorsal sides of antennal segments V. Fig. 126, fore wing. Fig. 127, first tarsal segment of the foreleg. Fig. 128, second tarsal segment of the hind leg.

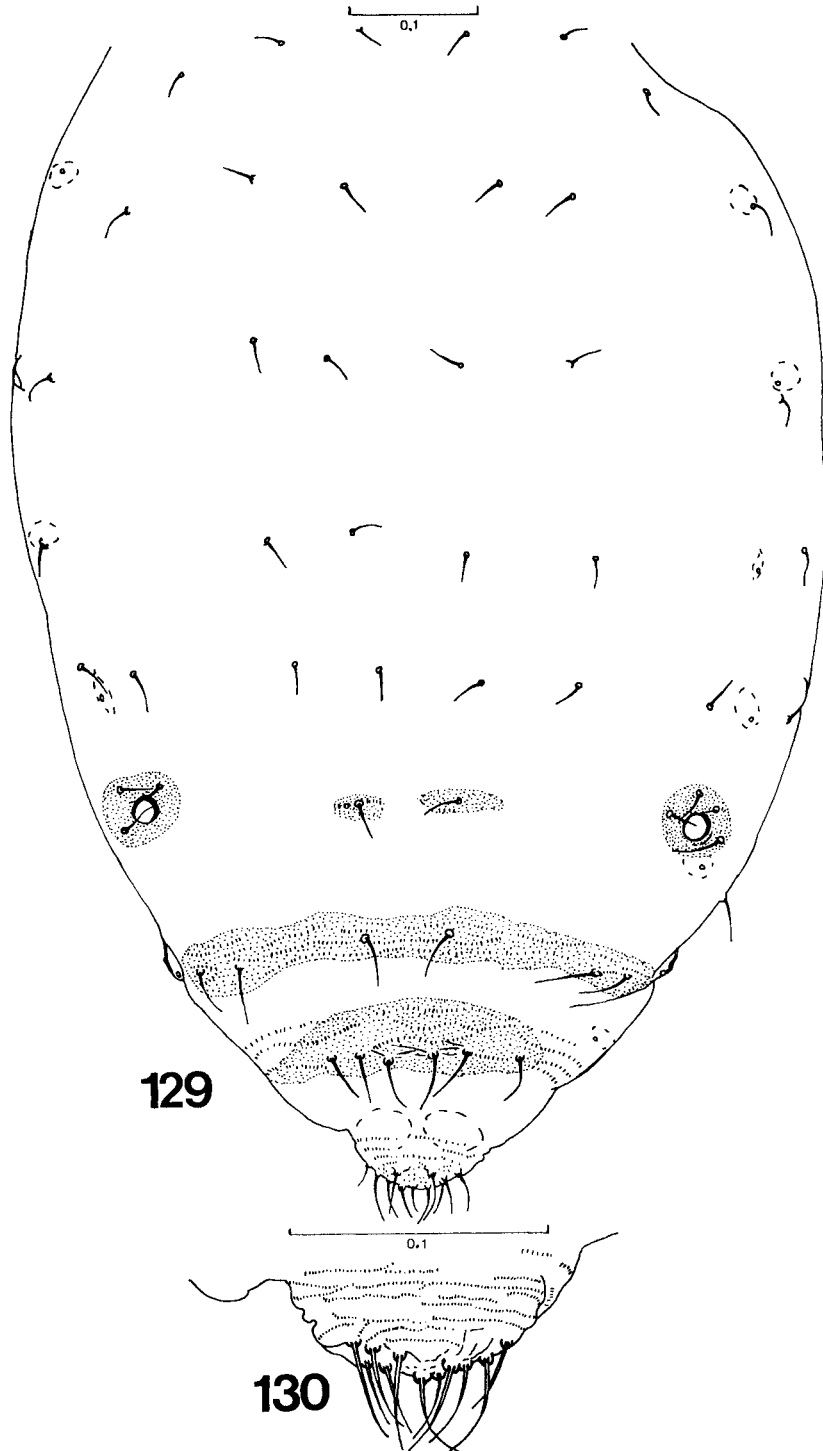

Figs. 129-130. *Astegopteryx setigera* spec. nov., alate viviparous ♀ from *Styrax* gall. Fig. 129, dorsal sides of abdominal segments I-VIII. Fig. 130, cauda.

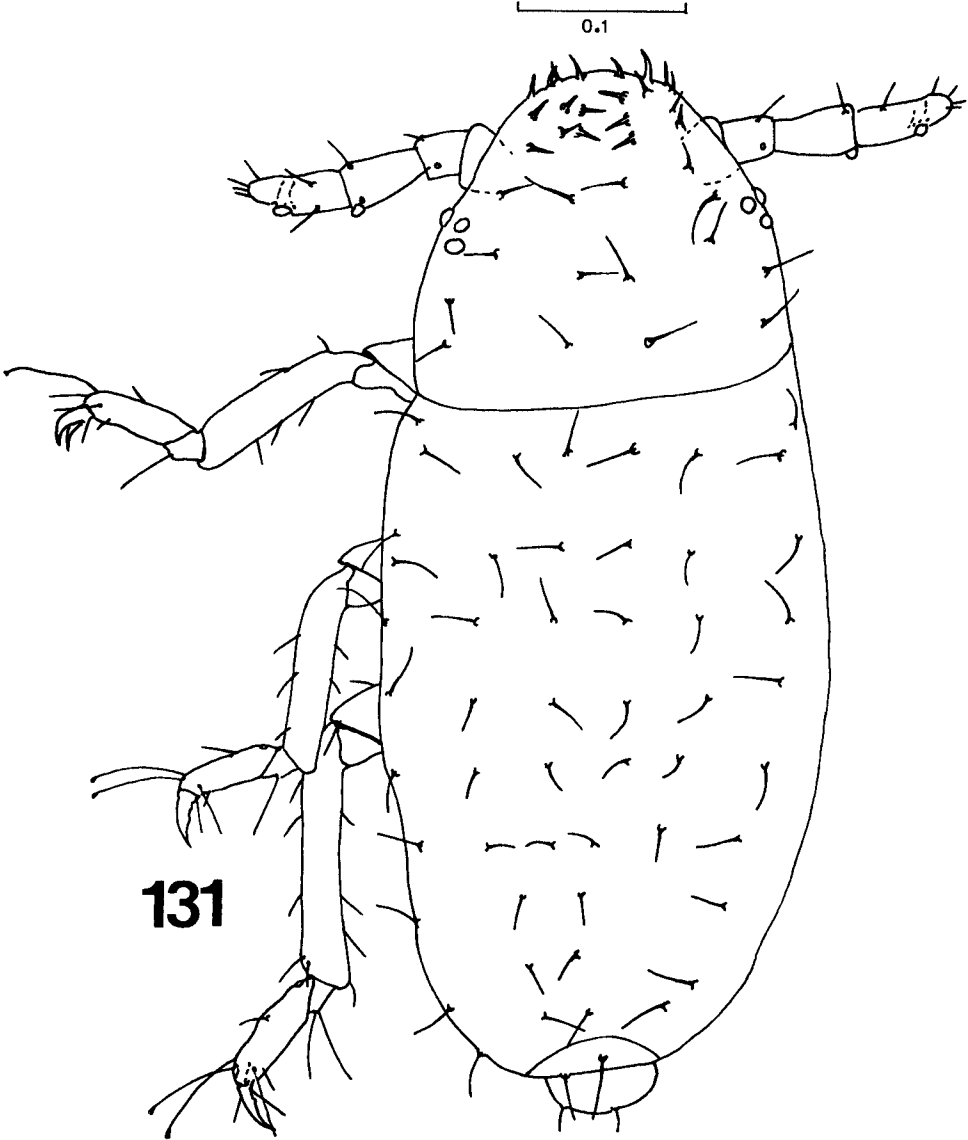
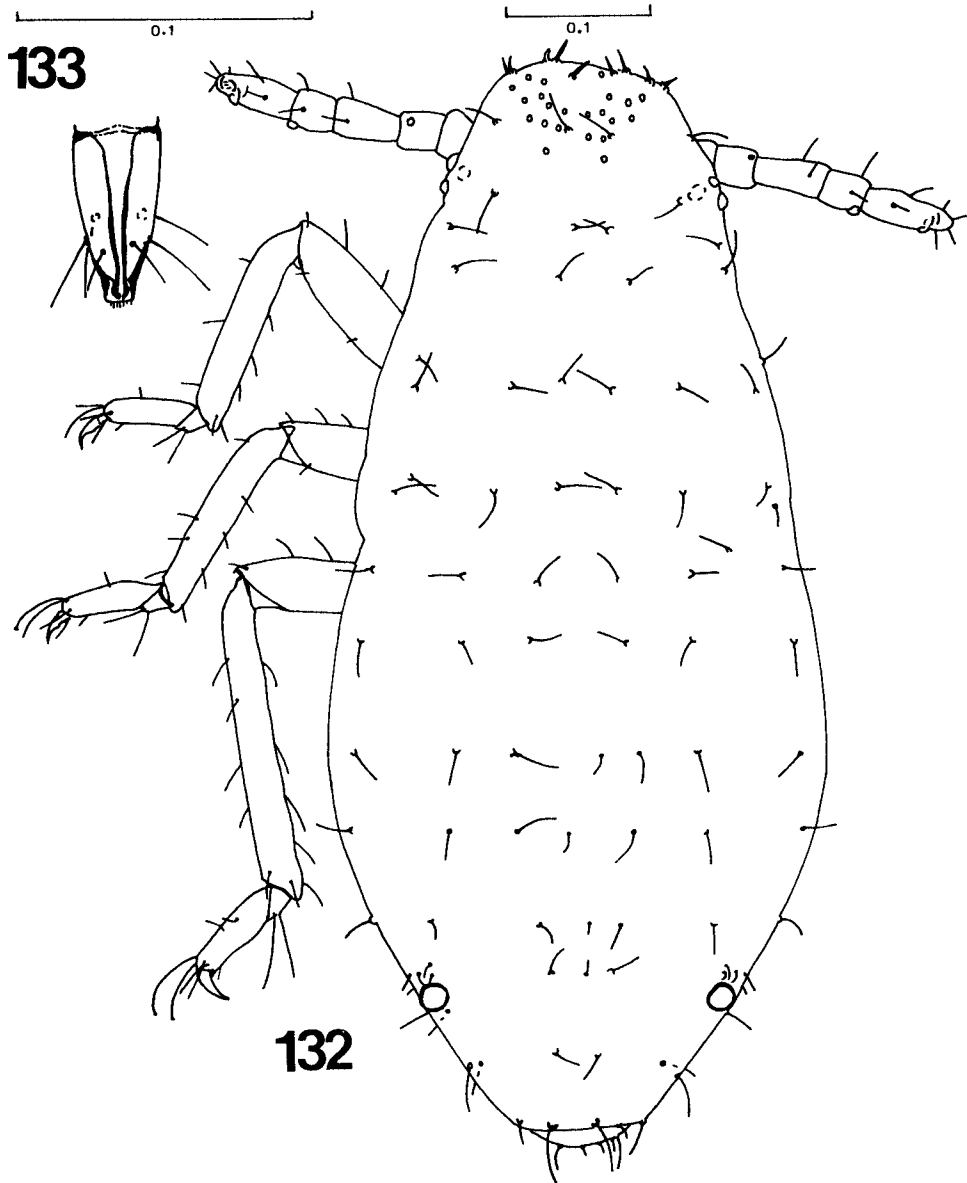
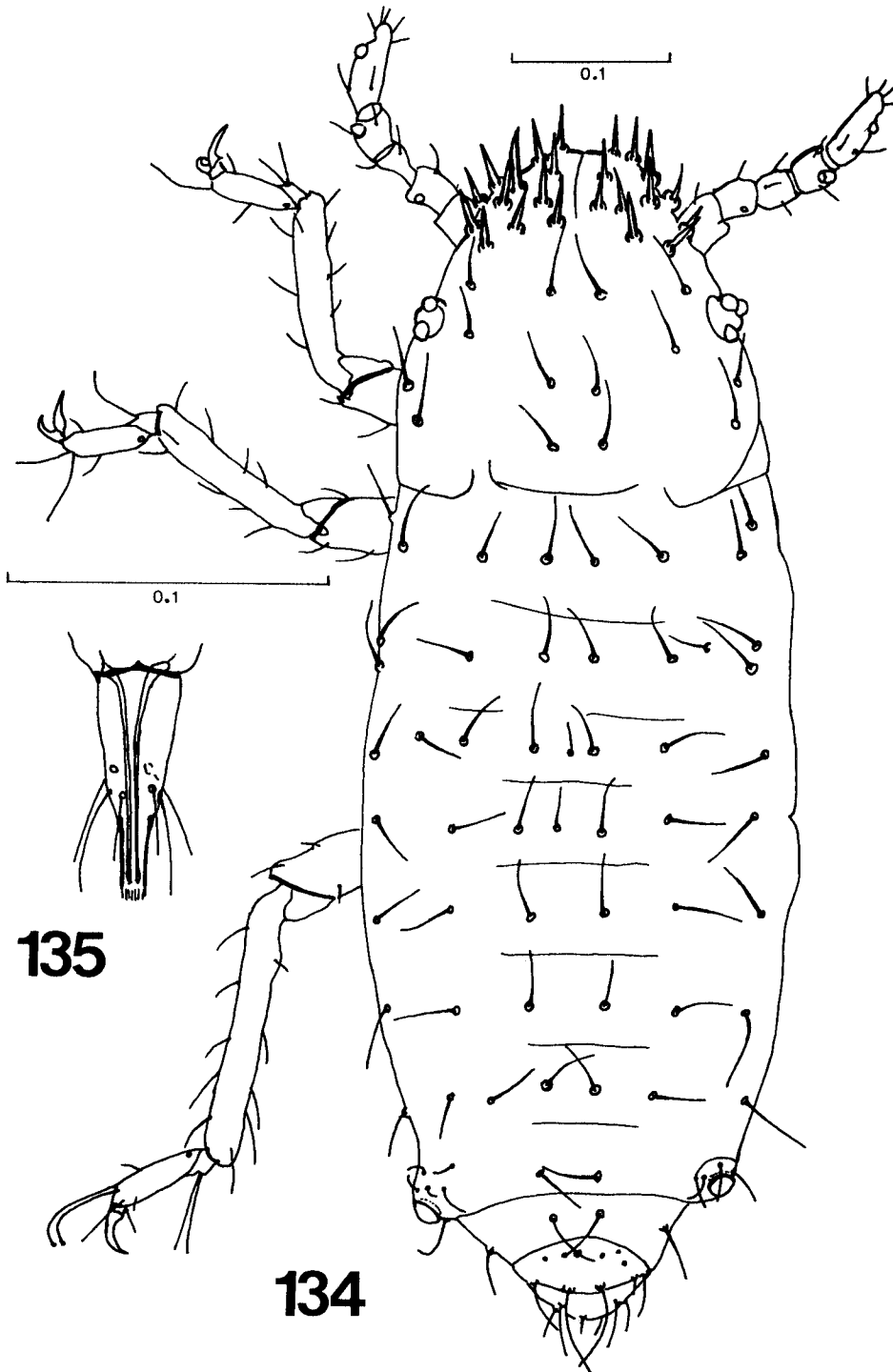

Fig. 131. *Astegopteryx setigera* spec. nov., first stage larva, normal.



Figs. 132-133. *Astegopteryx setigera* spec. nov., second stage normal larva. Fig. 132, dorsal side of the body. Fig. 133, ultimate rostral segment.



Figs. 134-135. *Astegopteryx setigera* spec. nov., second stage larva, soldier. Fig. 134, dorsal side of the body. Fig. 135, ultimate rostral segment.

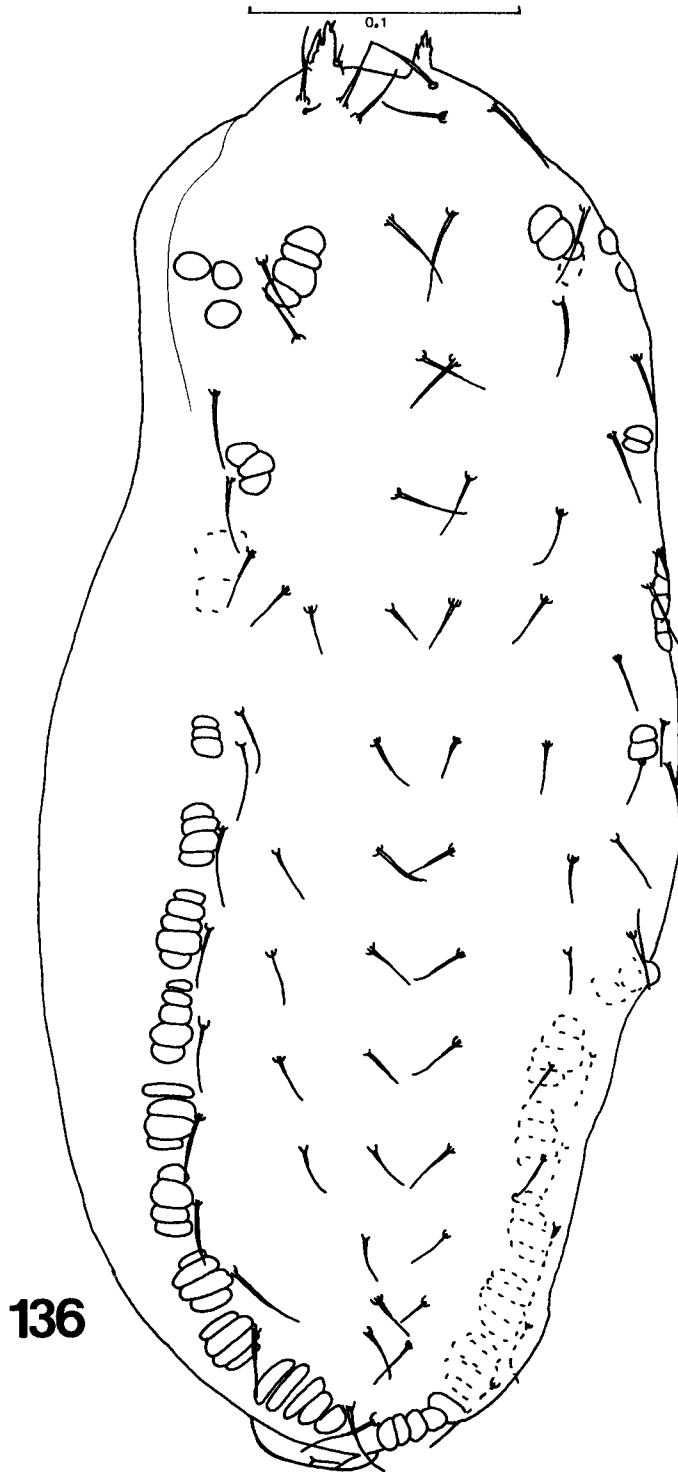

Fig. 136. *Astegopteryx setigera* spec. nov., embryo inside alate viviparous ♀ from *Styrax* gall.

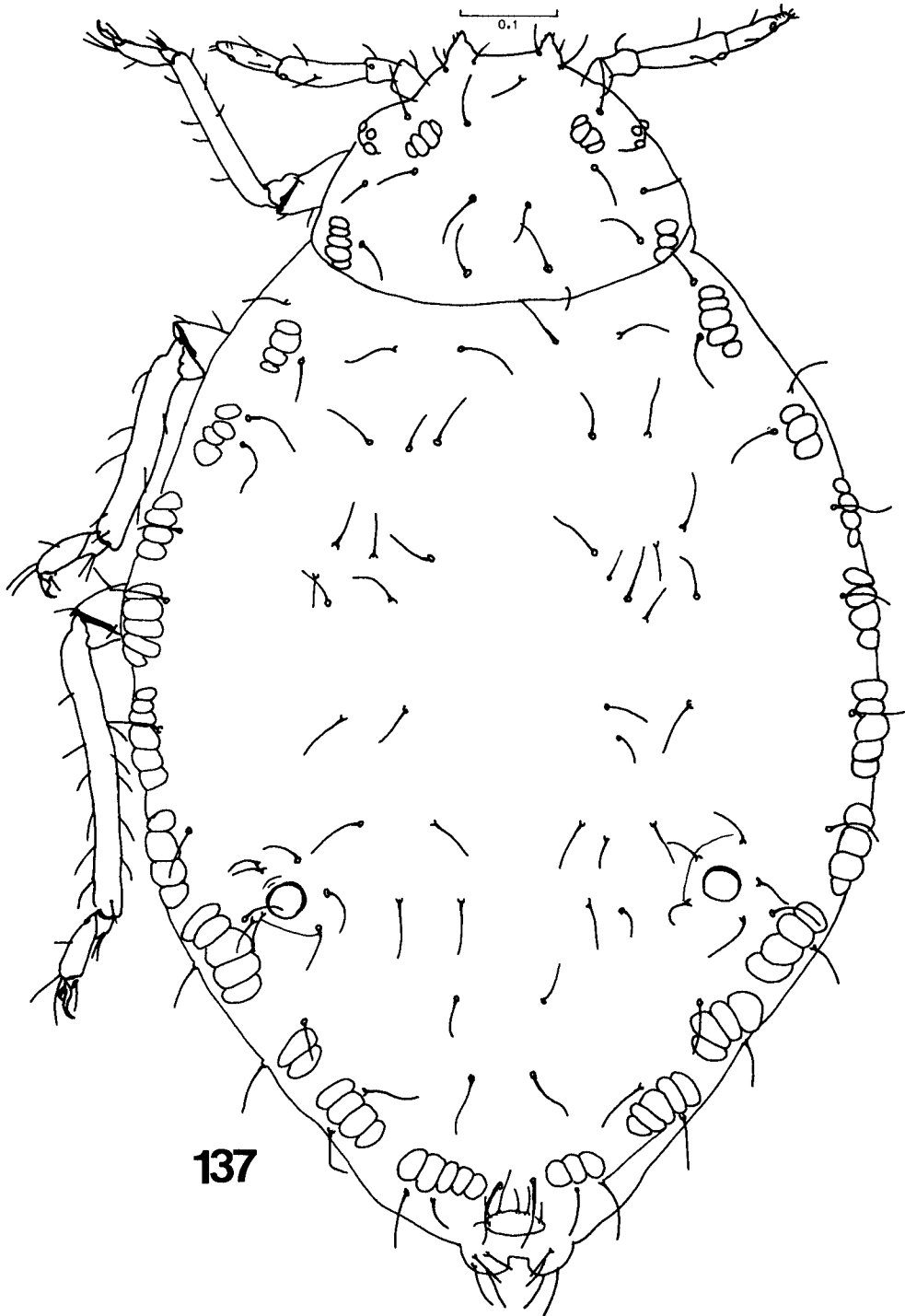

Fig. 137. *Astegopteryx singaporensis* (Van der Goot), dorsal side of apterous viviparous ♀.

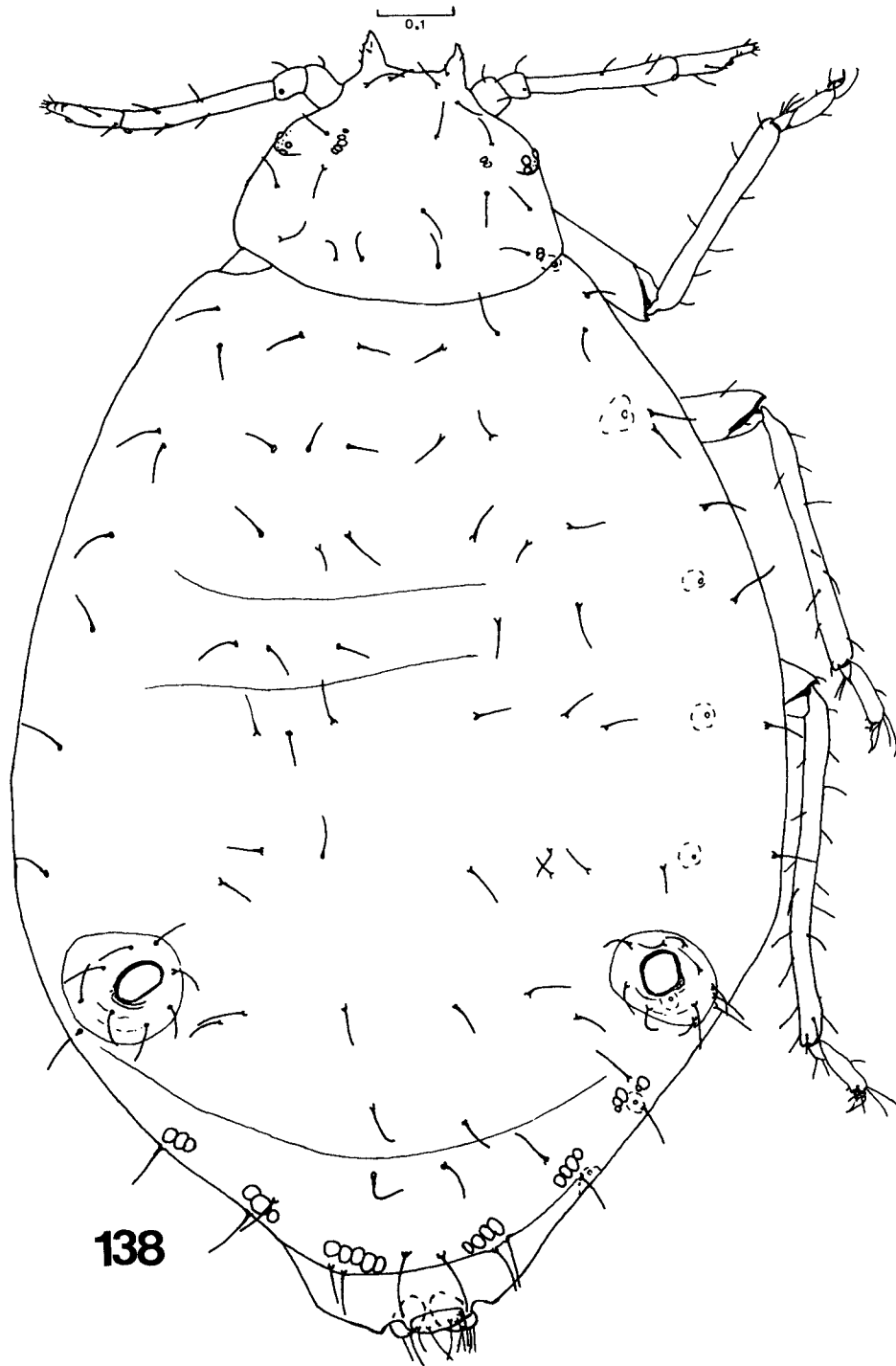
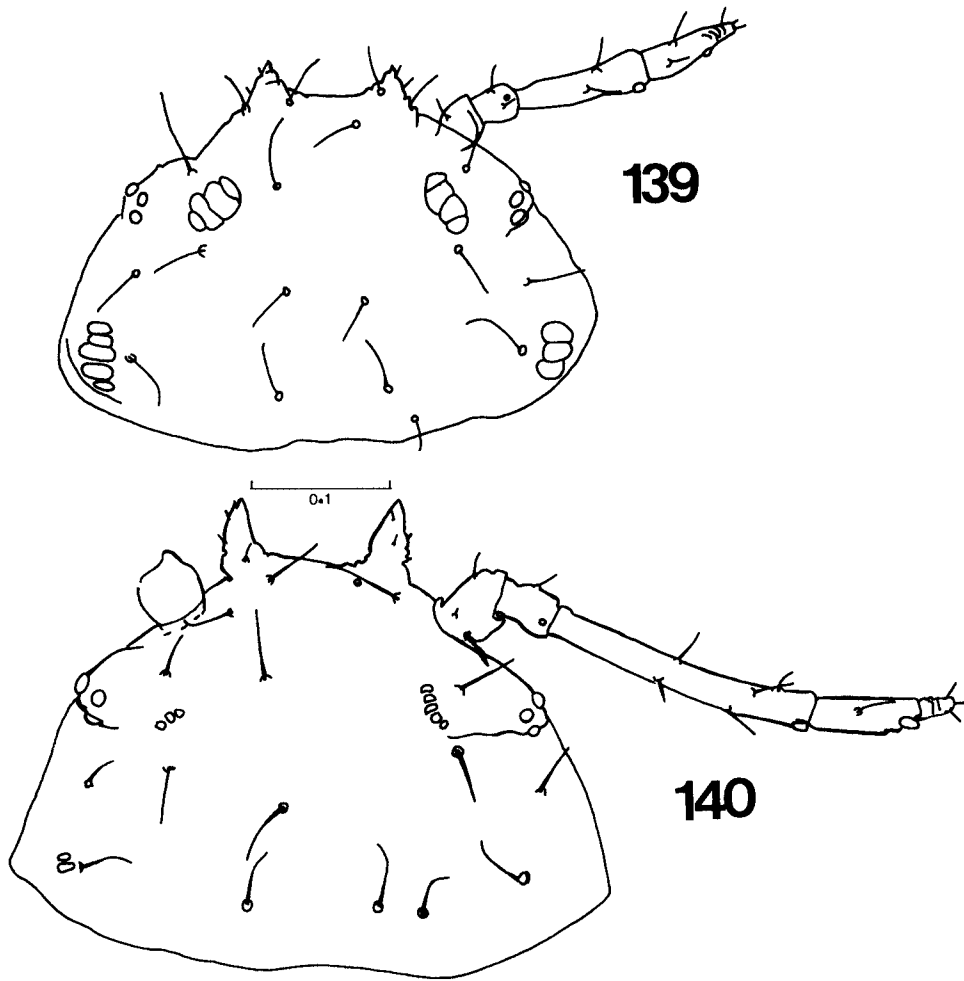

Fig. 138. *Astegopteryx singaporensis* (Van der Goot), apterous viviparous ♀, dorsal side of apterous viviparous ♀.





Figs. 139-140. *Astegopteryx singaporensis* (Van der Goot), apterous viviparous ♀, dorsal sides of two heads.

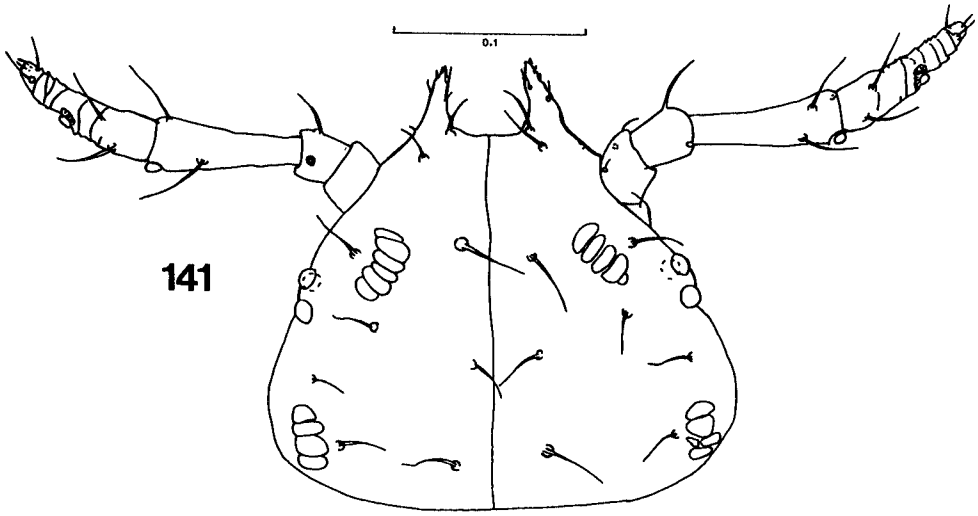
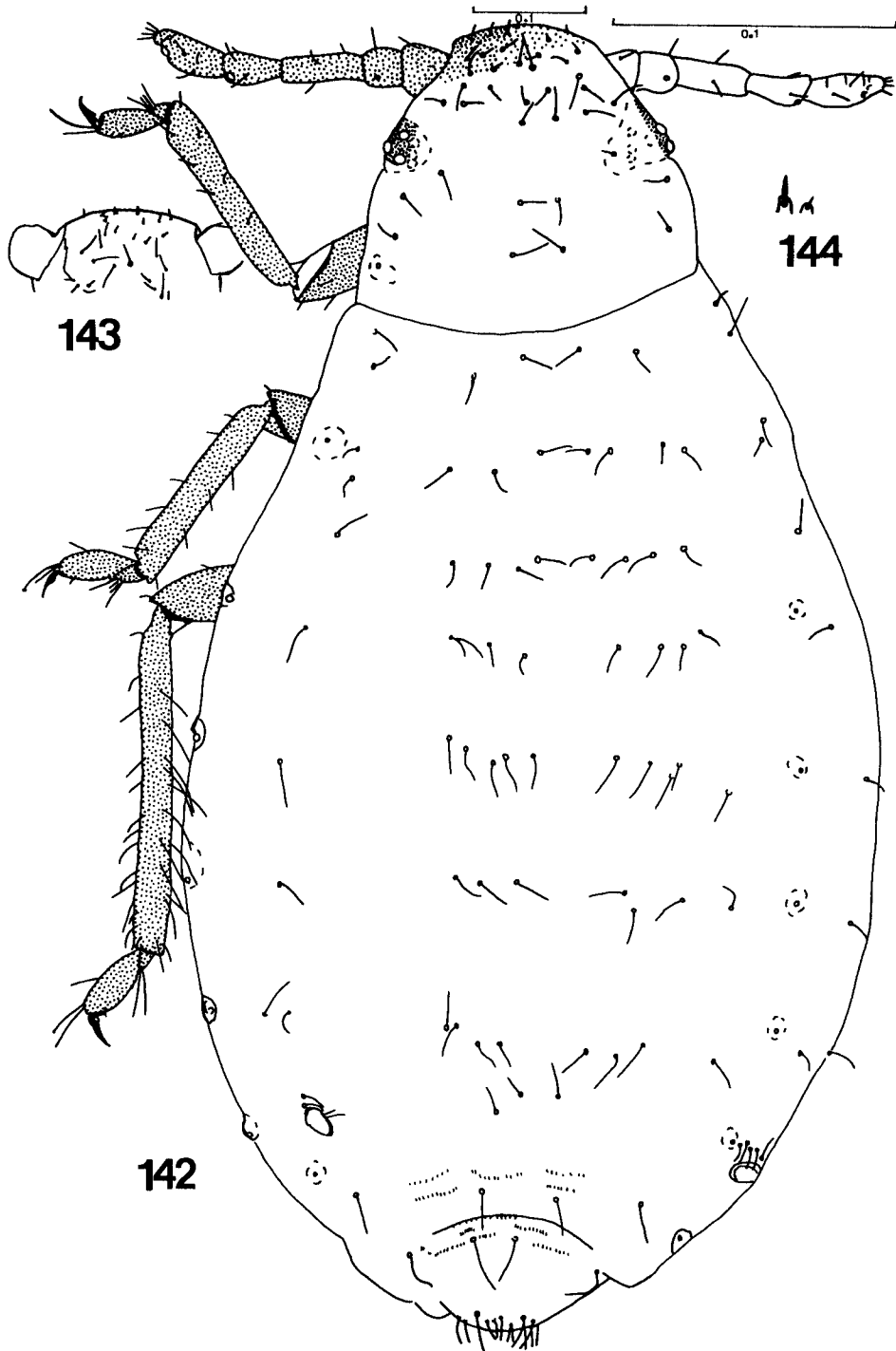
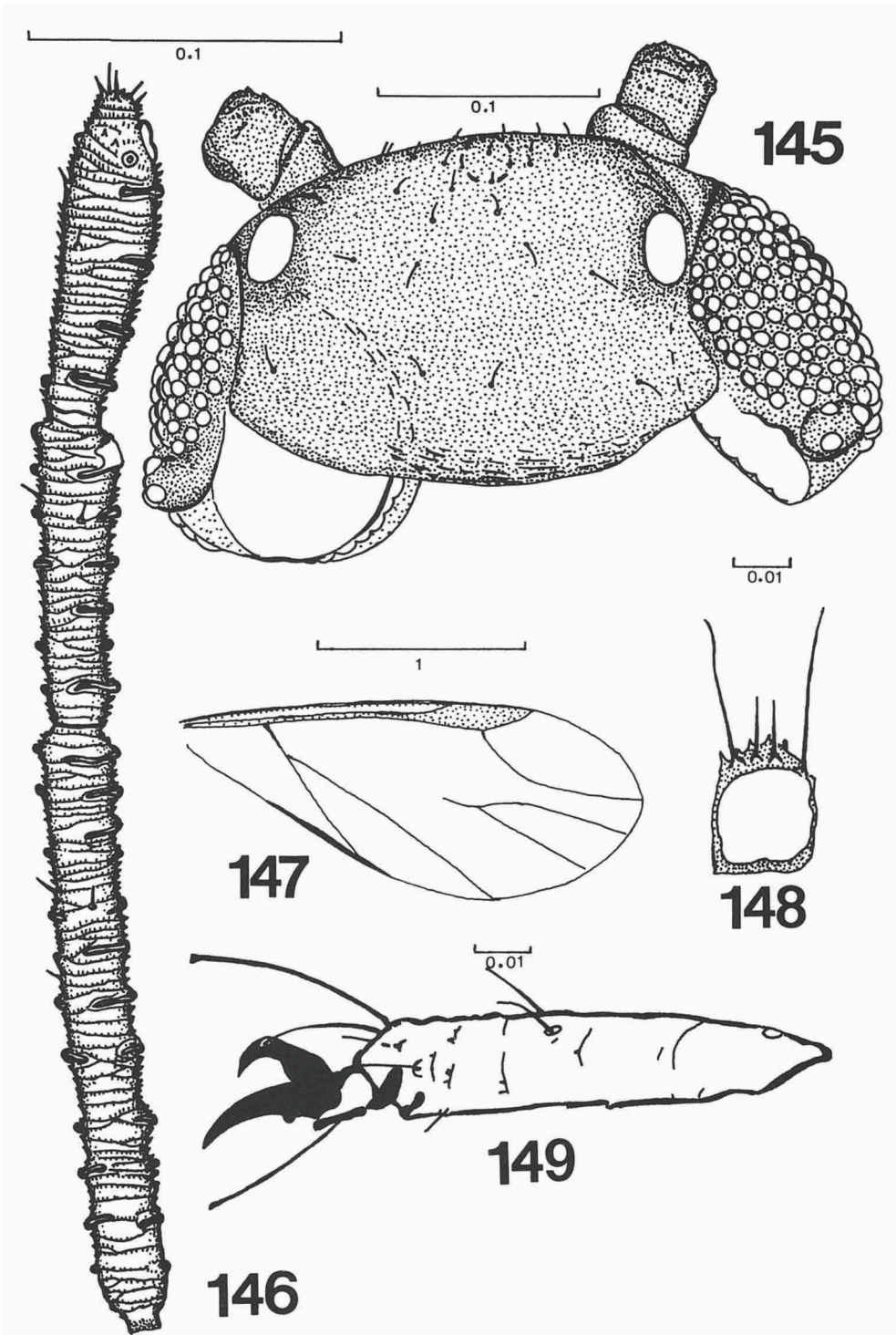

Fig. 141. *Astegopteryx singaporensis* (Van der Goot), dorsal side of the head.



Figs. 142-144. *Astegopteryx styracophila* Karsch, apterous viviparous ♀. Fig. 142, dorsal side of the body. Fig. 143, ventral side of the frons. Fig. 144, dagger hairs ventrally on the head of two specimens. Fig. 143, same scale line as the body.



Figs. 145-149. *Astegopteryx styracophila* Karsch, alate viviparous ♀. Fig. 145, dorsal side of the head. Fig. 146, dorsal side of antennal segments III-V. Fig. 147, fore wing. Fig. 148, first tarsal segment of the foreleg. Fig. 149, second tarsal segment of the hind leg.

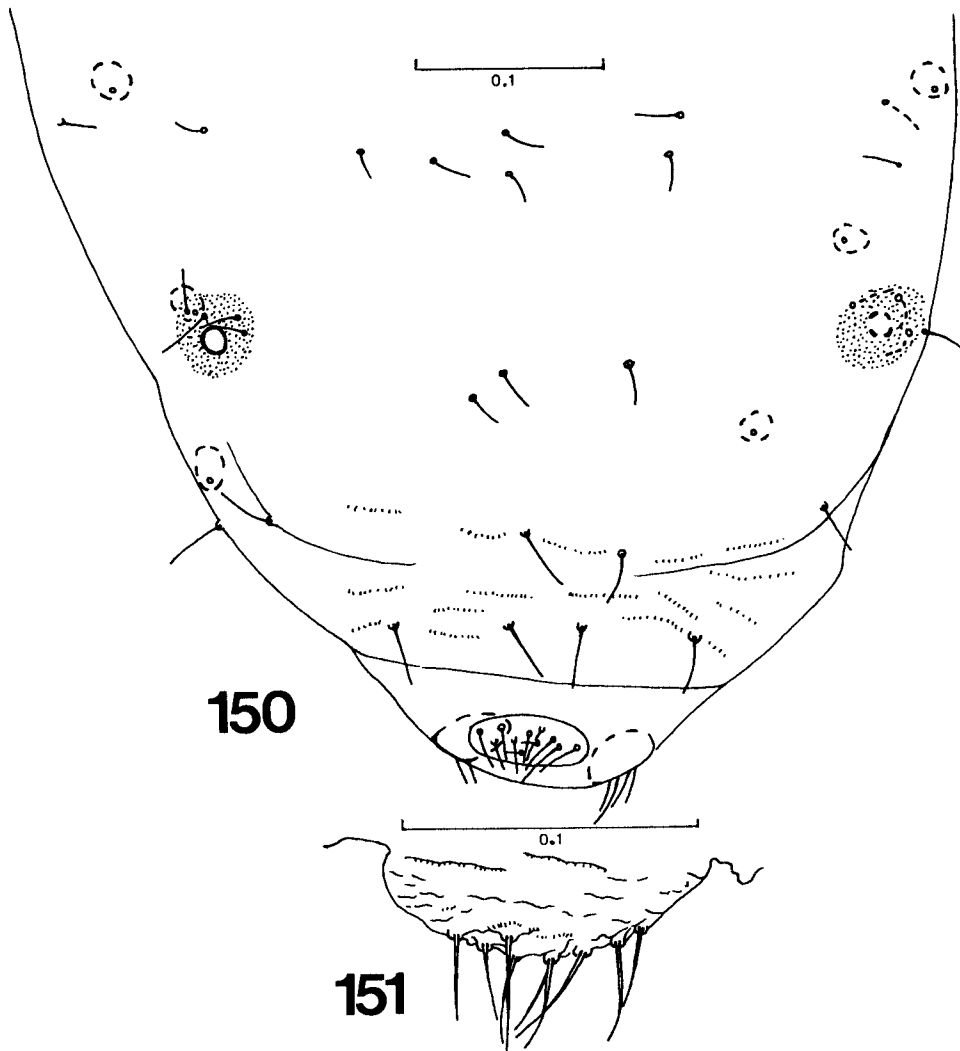

Figs. 150-151. *Astegopteryx styracophila* Karsch, alate viviparous ♀. Fig. 150, dorsal sides of abdominal segments V-VIII. Fig. 151, cauda.

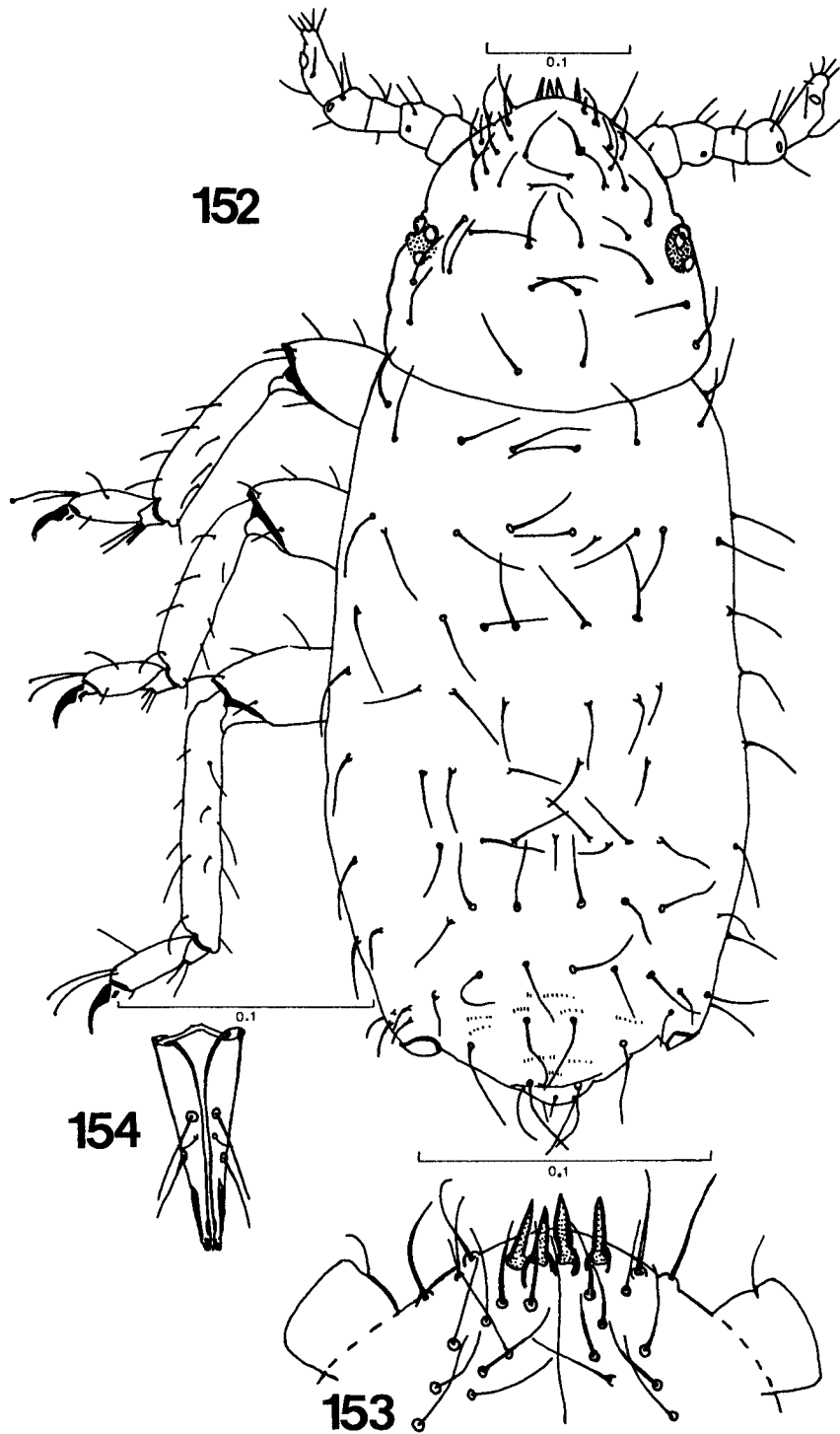

Figs. 152-154. *Astegopteryx styracophila* Karsch, second stage larva, soldier. Fig. 152 dorsal side of the body. Fig. 153, ventral side of the frons. Fig. 154, ultimate rostral segment.

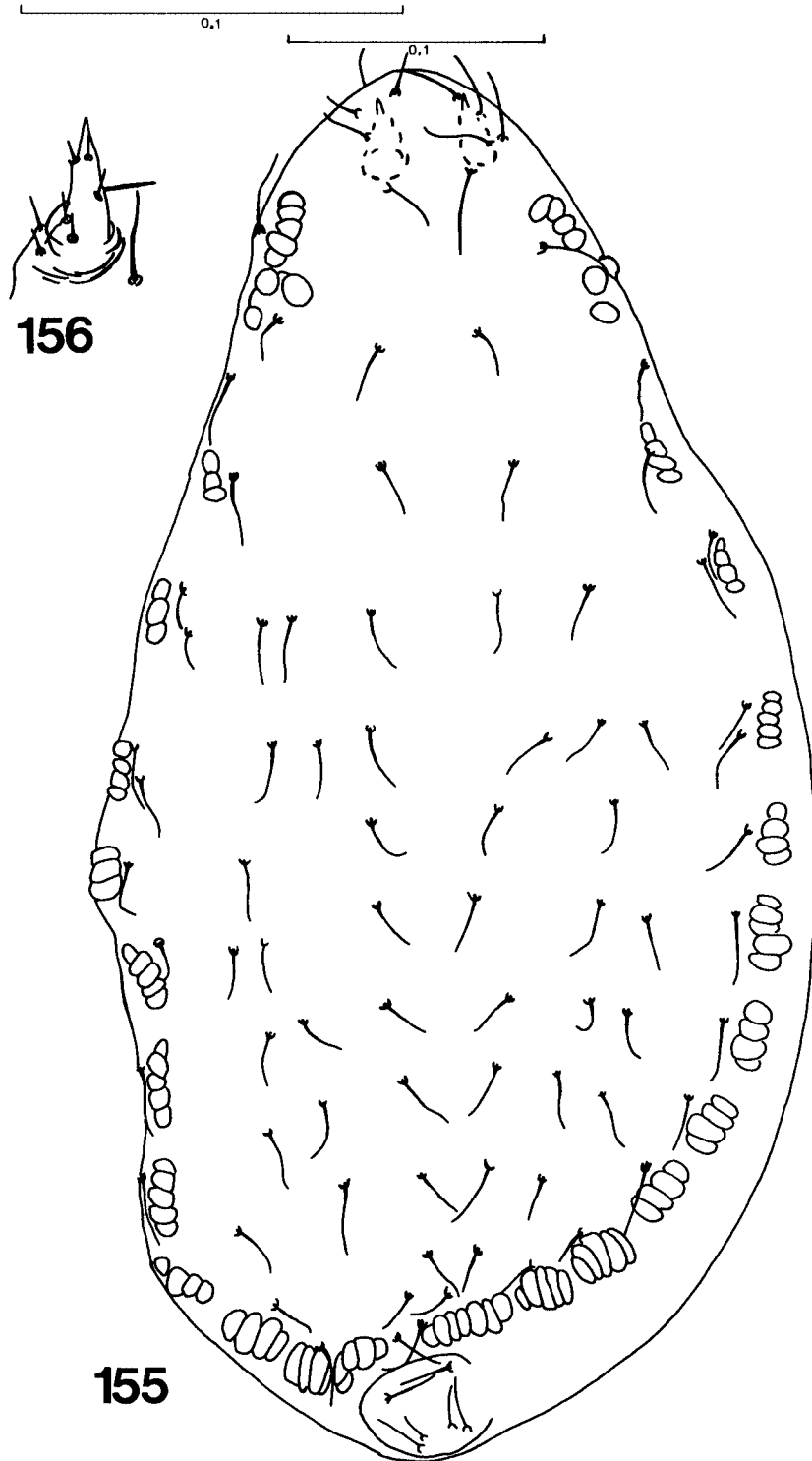

Figs. 155-156. *Astegopteryx styracophila* Karsch, embryo inside alate viviparous ♀. Fig. 155, dorsal side of the body. Fig. 156, horn on the ventral side of the frons.

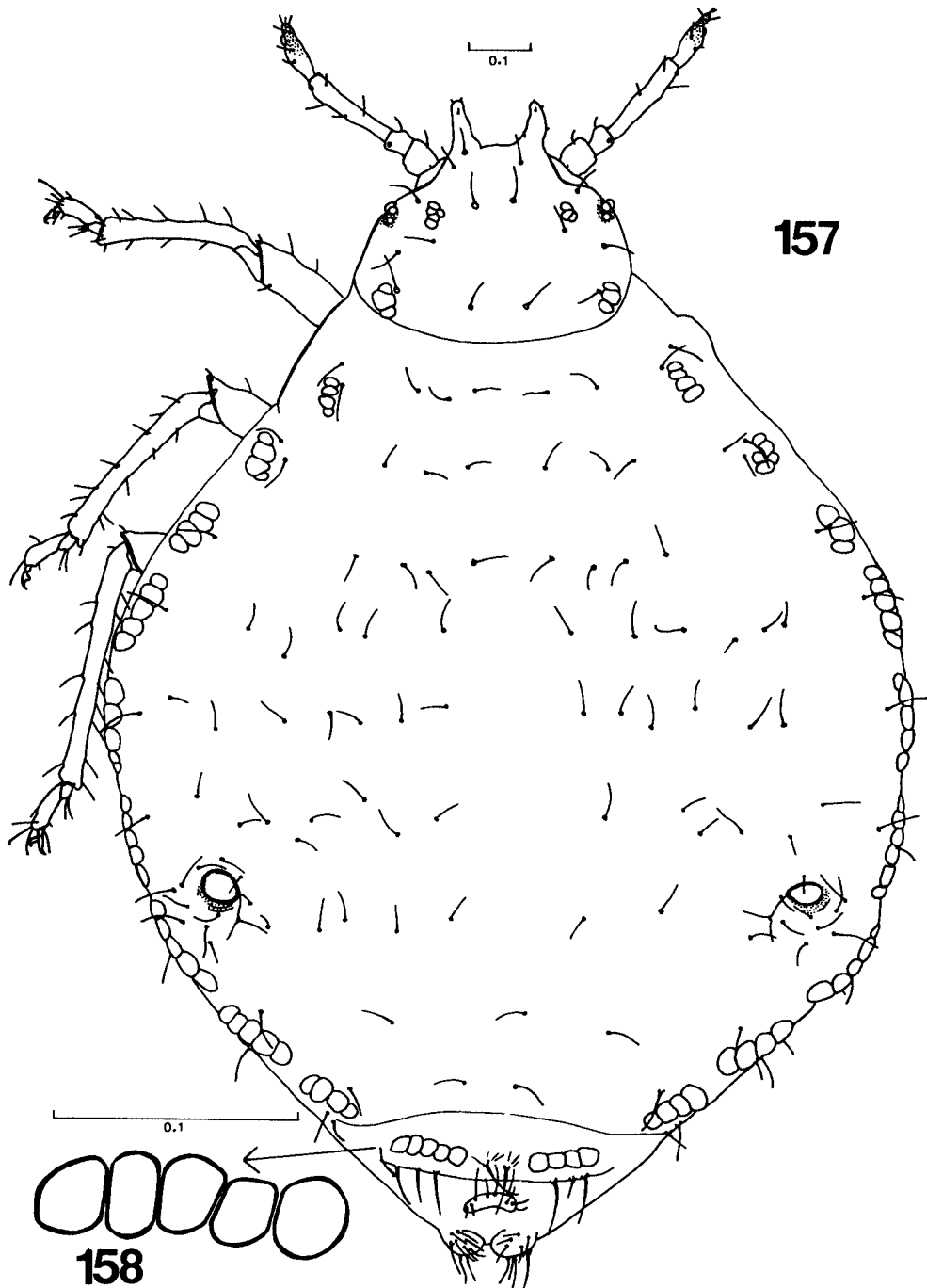

Figs. 157-158. *Astegopteryx unimaculata* nomen novum. Fig. 157, dorsal side of the body of apterous viviparous ♀. Fig. 158, wax glands on abdominal segment VIII.



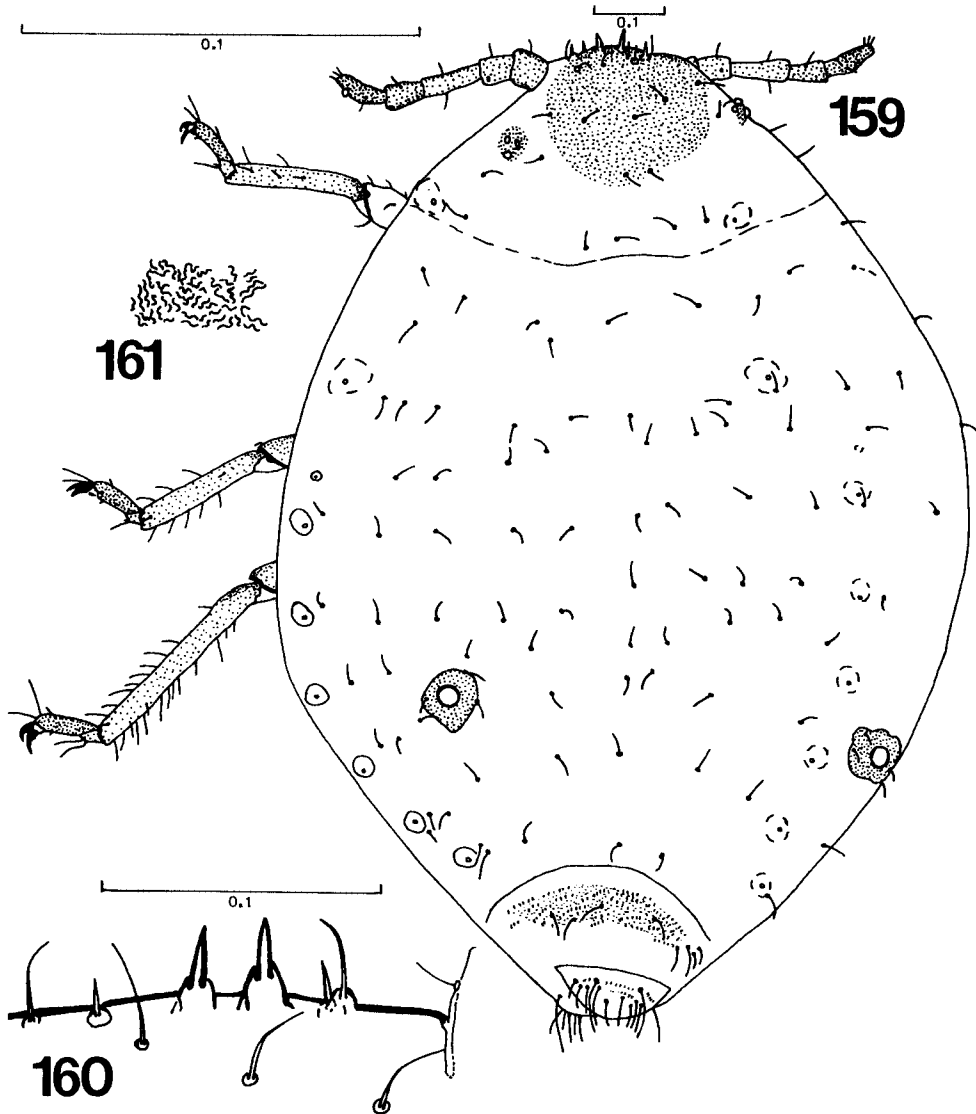

Figs. 159-161. *Cerataphis fransseni* (Hille Ris Lambers), apterous viviparous ♀ from *Styrax* gall. Fig. 159, dorsal side of the body. Fig. 160, frontal part of the head. Fig. 161, s-shaped wax glands.

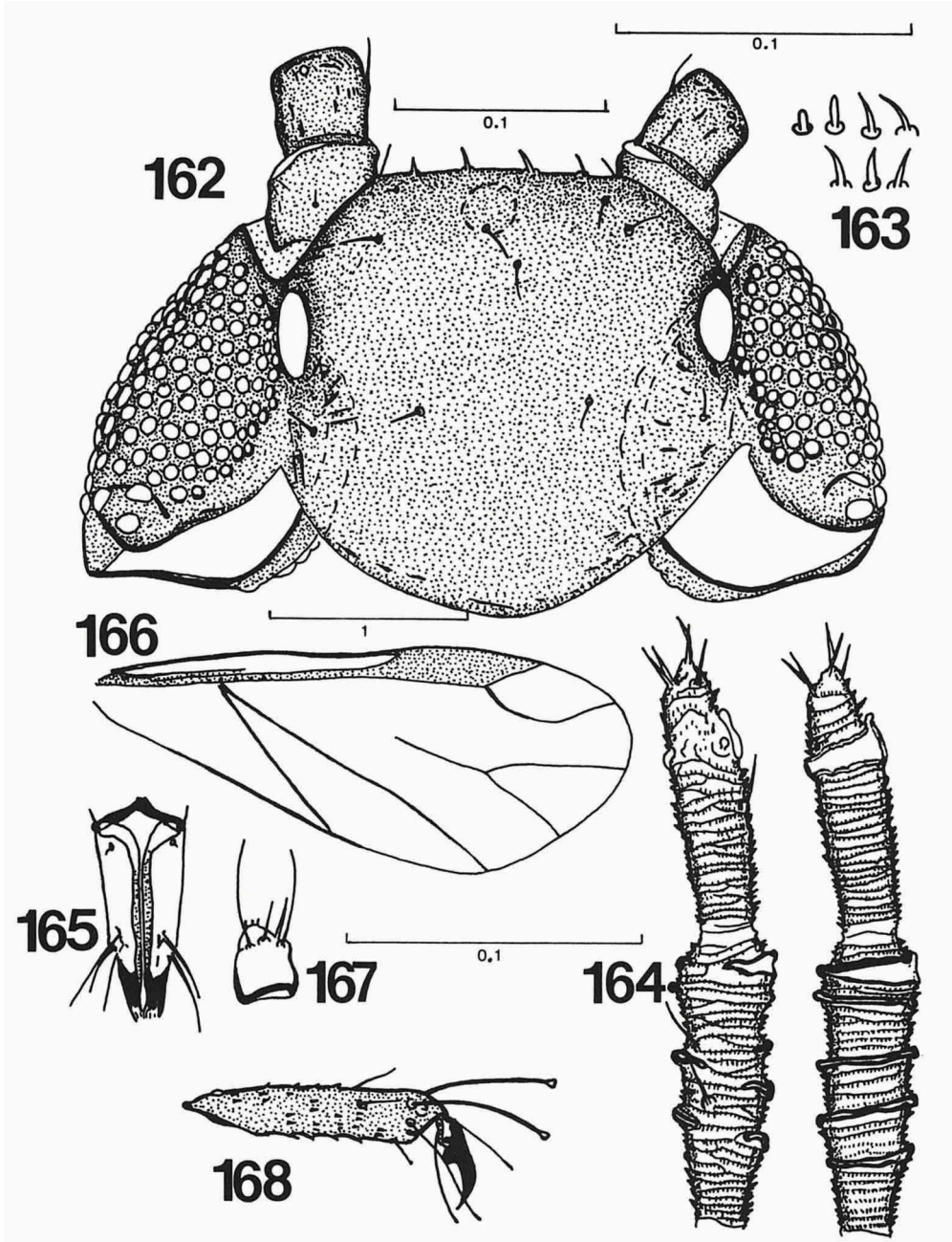

Figs. 162-168. *Cerataphis fransseni* (Hille Ris Lambers), alate viviparous ♀. Fig. 162, dorsal side of the head. Fig. 163, small dagger hairs on the frons of the head of some specimens. Fig. 164, dorsal (left) and ventral (right) side of antennal segments IV and V. Fig. 165, ultimate rostral segment. Fig. 166, fore wing. Fig. 167, first tarsal segment of the foreleg. Fig. 168, second tarsal segment of the hind leg.

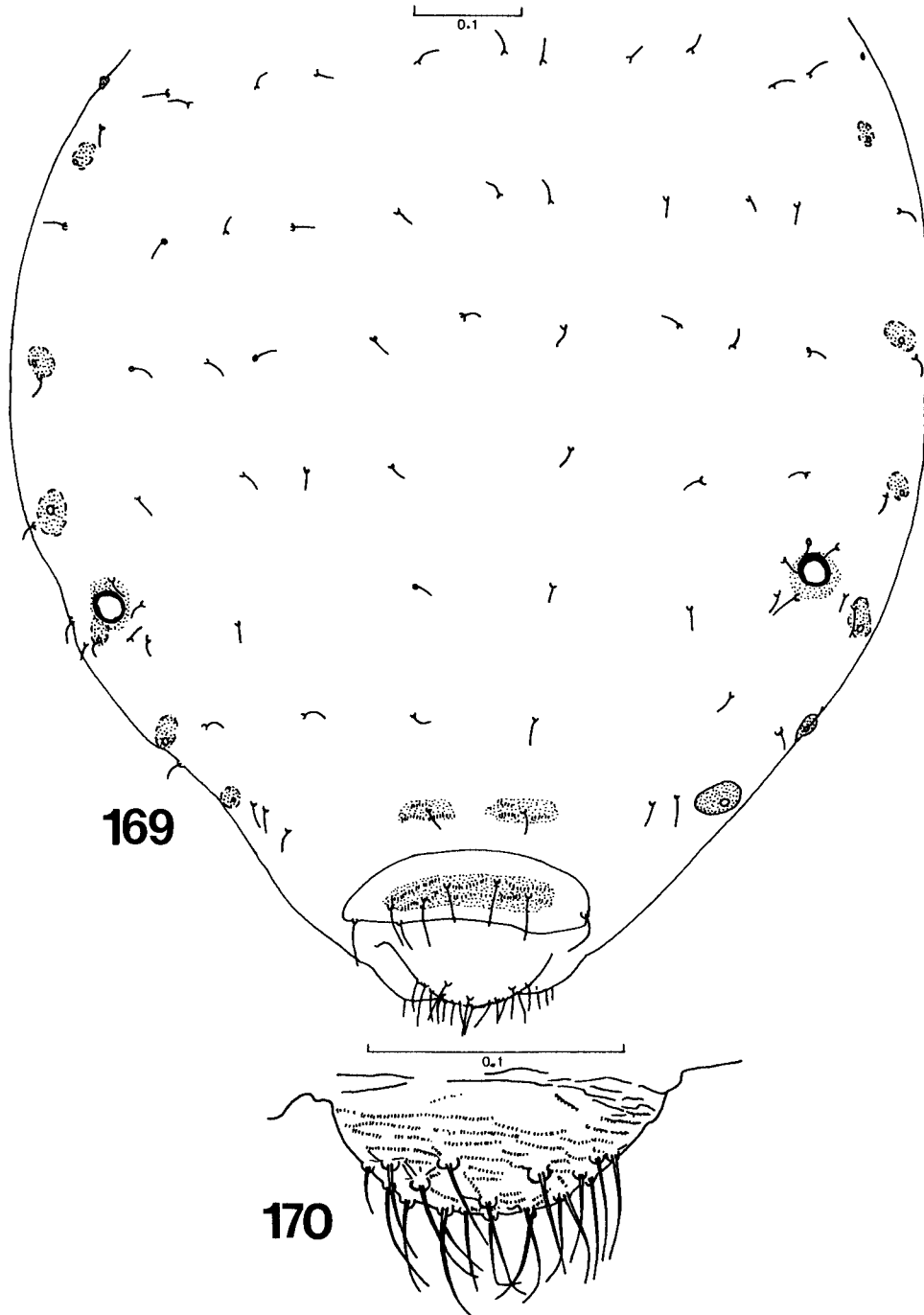

Figs. 169-170. *Cerataphis fransseni* (Hille Ris Lambers), alate viviparous ♀. Fig. 169, dorsal sides of abdominal segments I-VIII. Fig. 170, cauda.

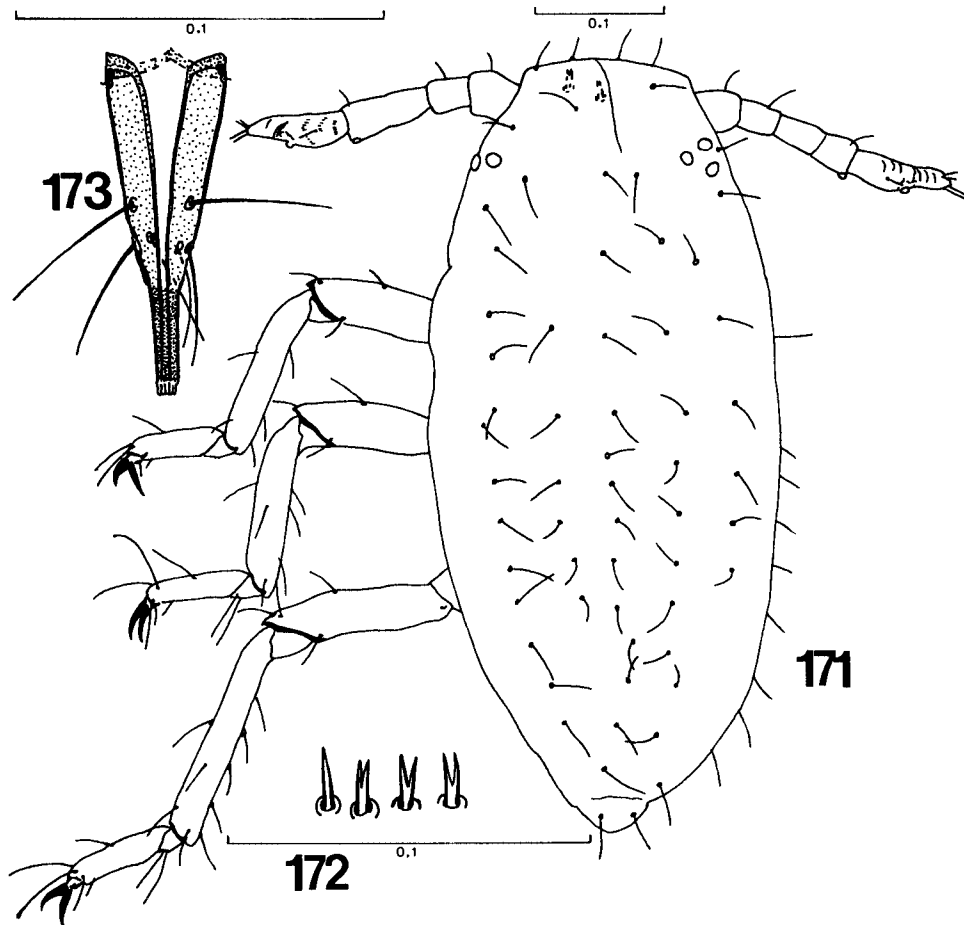

Figs. 171-173. *Cerataphis fransseni* (Hille Ris Lambers), first stage larva, normal apterous viviparous ♀ from *Styrax* gall. Fig. 171, dorsal side of the body. Fig. 172, dagger hairs ventrally on the head. Fig. 173, ultimate rostral segment.

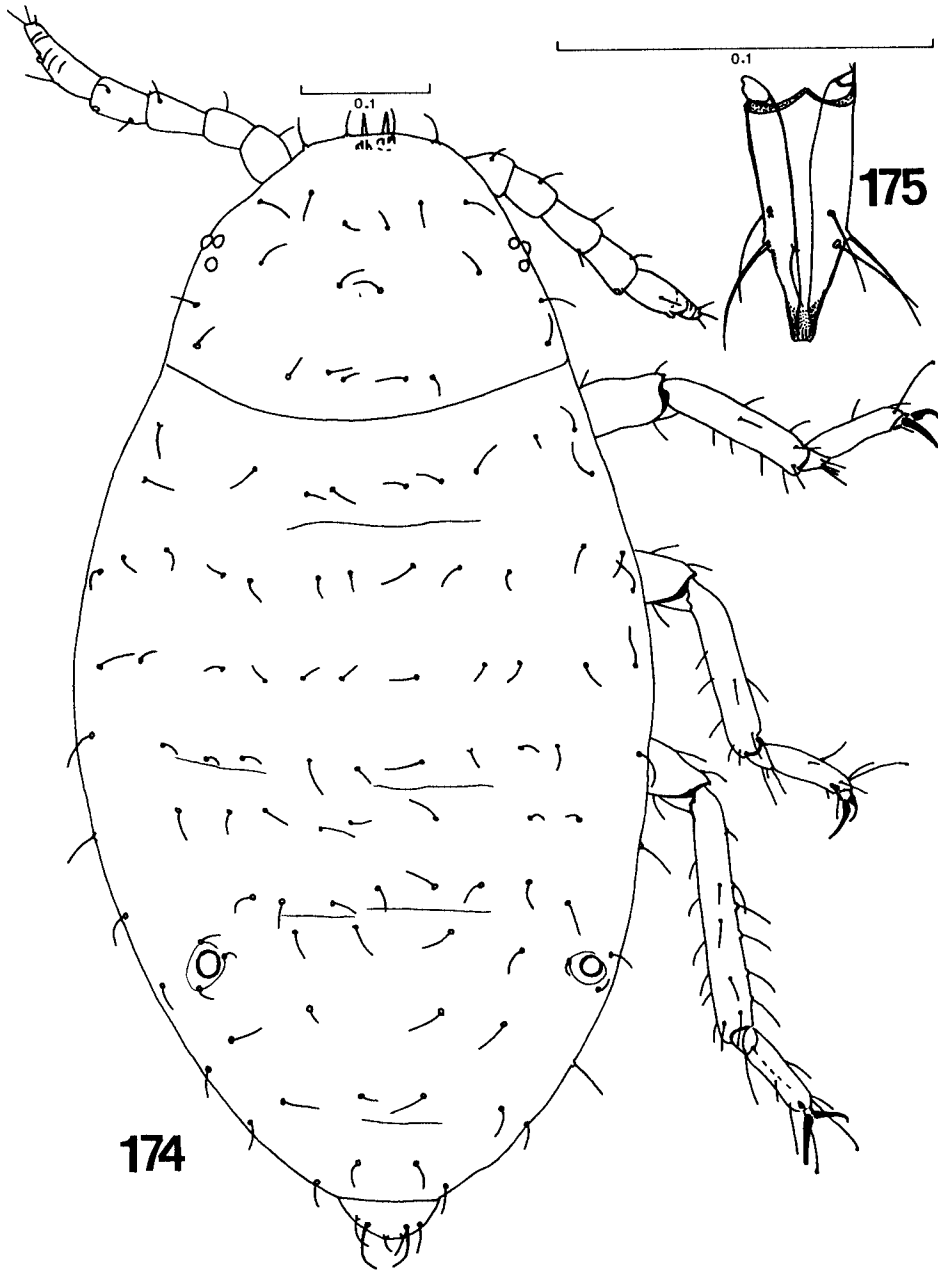

Figs. 174-175. *Cerataphis fransseni* (Hille Ris Lambers), second stage normal larva from *Styrax* gall. Fig. 174, dorsal side of the body. Fig. 175, ultimate rostral segment.

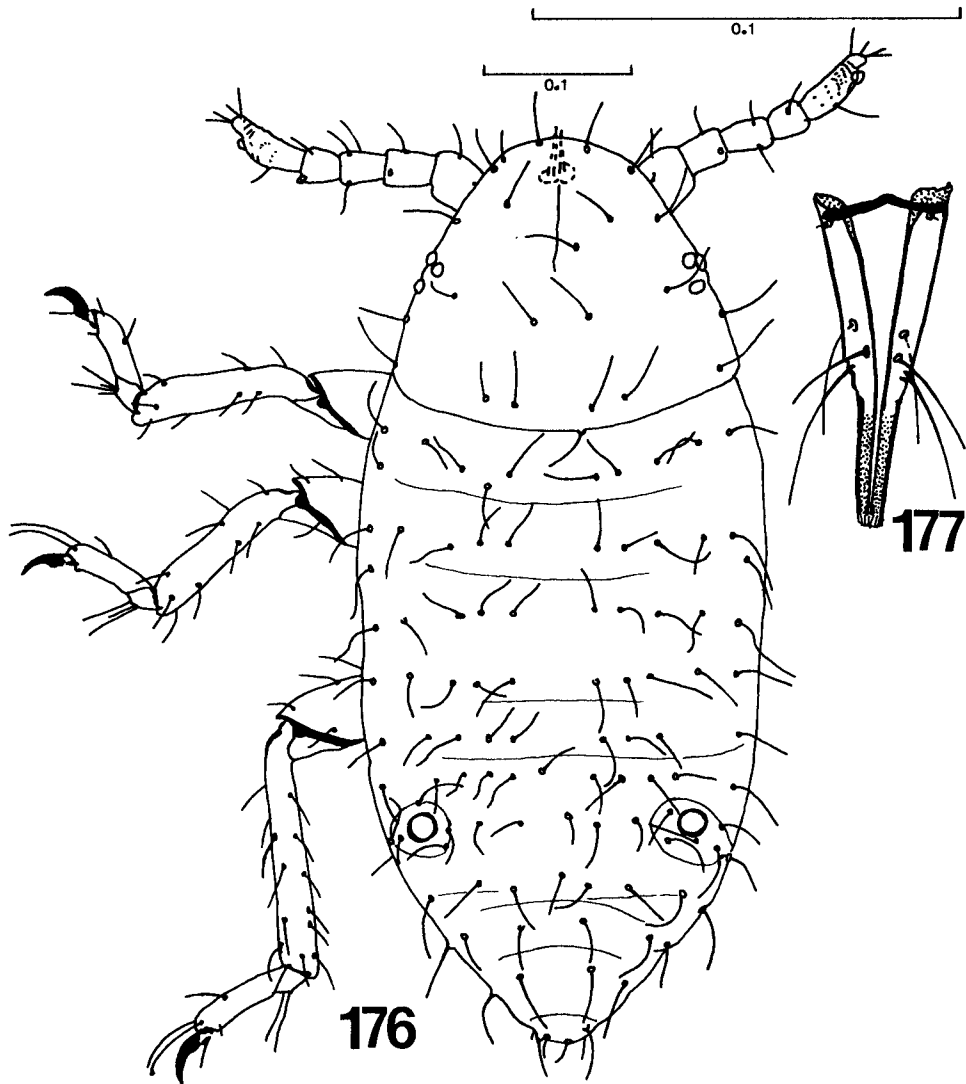

Figs. 176-177. *Cerataphis fransseni* (Hille Ris Lambers), second stage larva, soldier, from *Styrax* gall. Fig. 176, dorsal side of the body. Fig. 177, ultimate rostral segment.

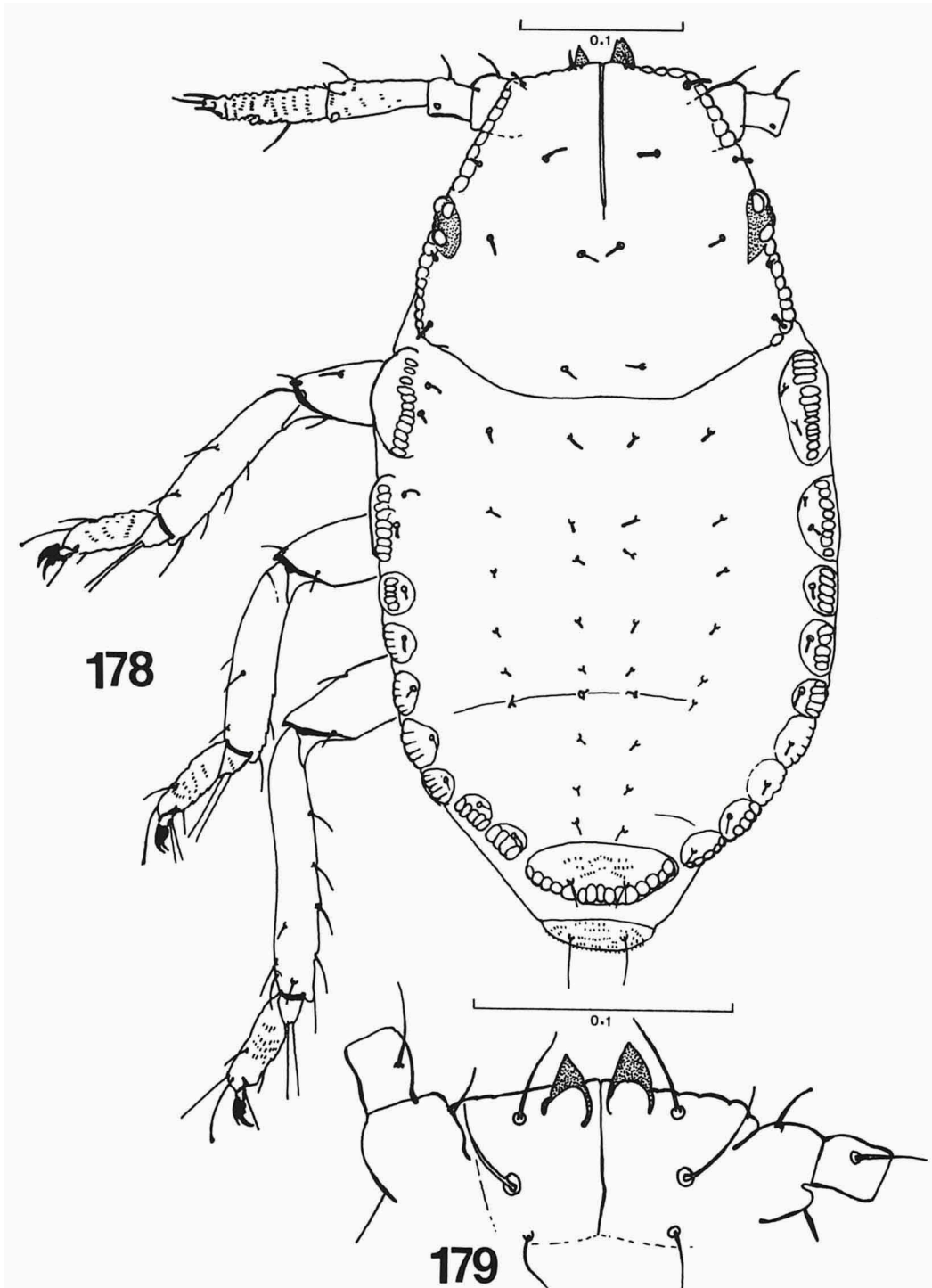

Figs. 178-179. *Cerataphis fransseni* (Hille Ris Lambers), first stage larva, the first day after birth from alate from *Styrax* gall. Fig. 178, dorsal side of the body. Fig. 179, ventral side of the frons of the head.

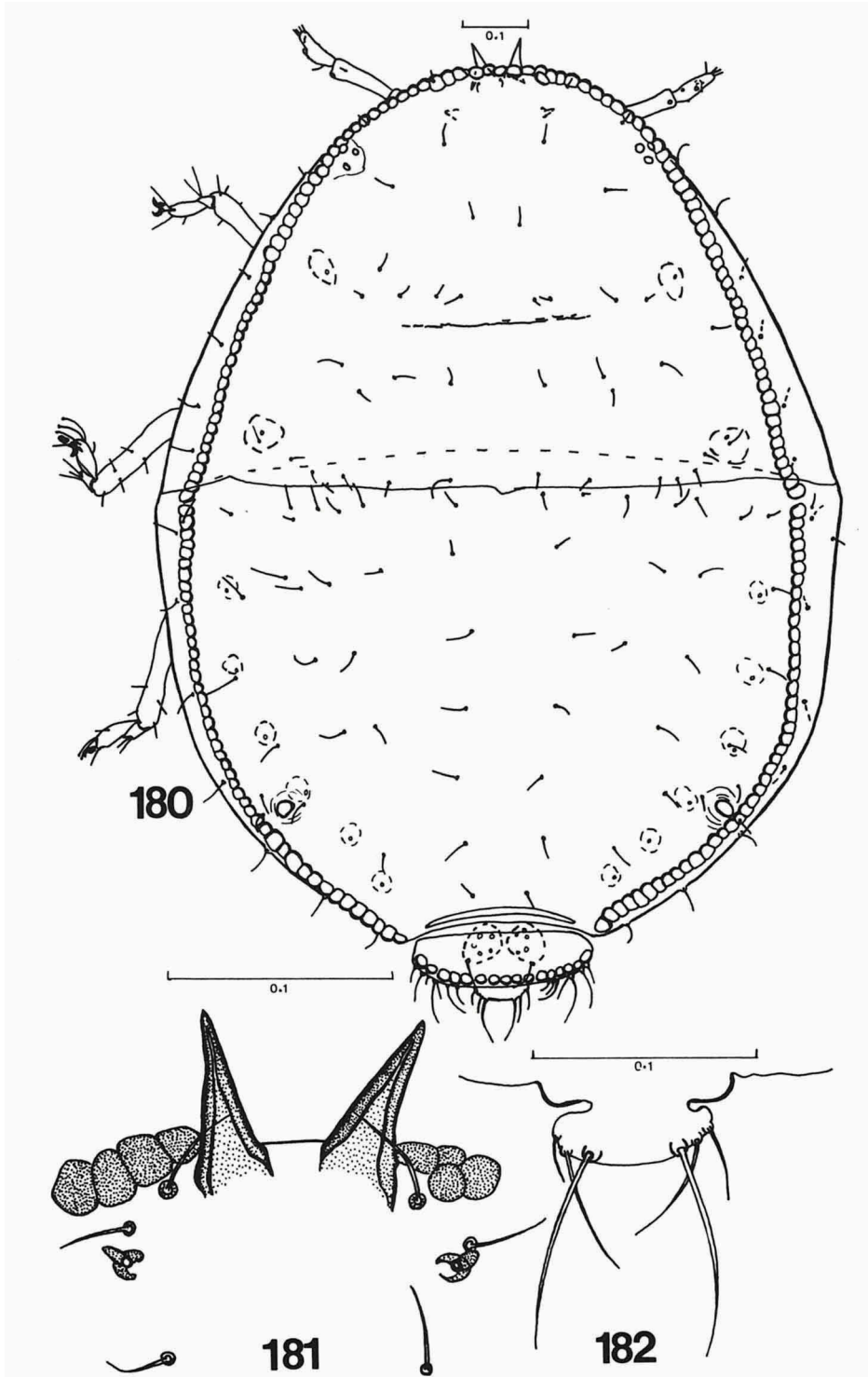

Figs. 180-182. *Cerataphis freycinetiae* Van der Goot, apterous viviparous ♀. Fig. 180, dorsal side of the body. Fig. 181, anterior ventral part of the head. Fig. 182, cauda.



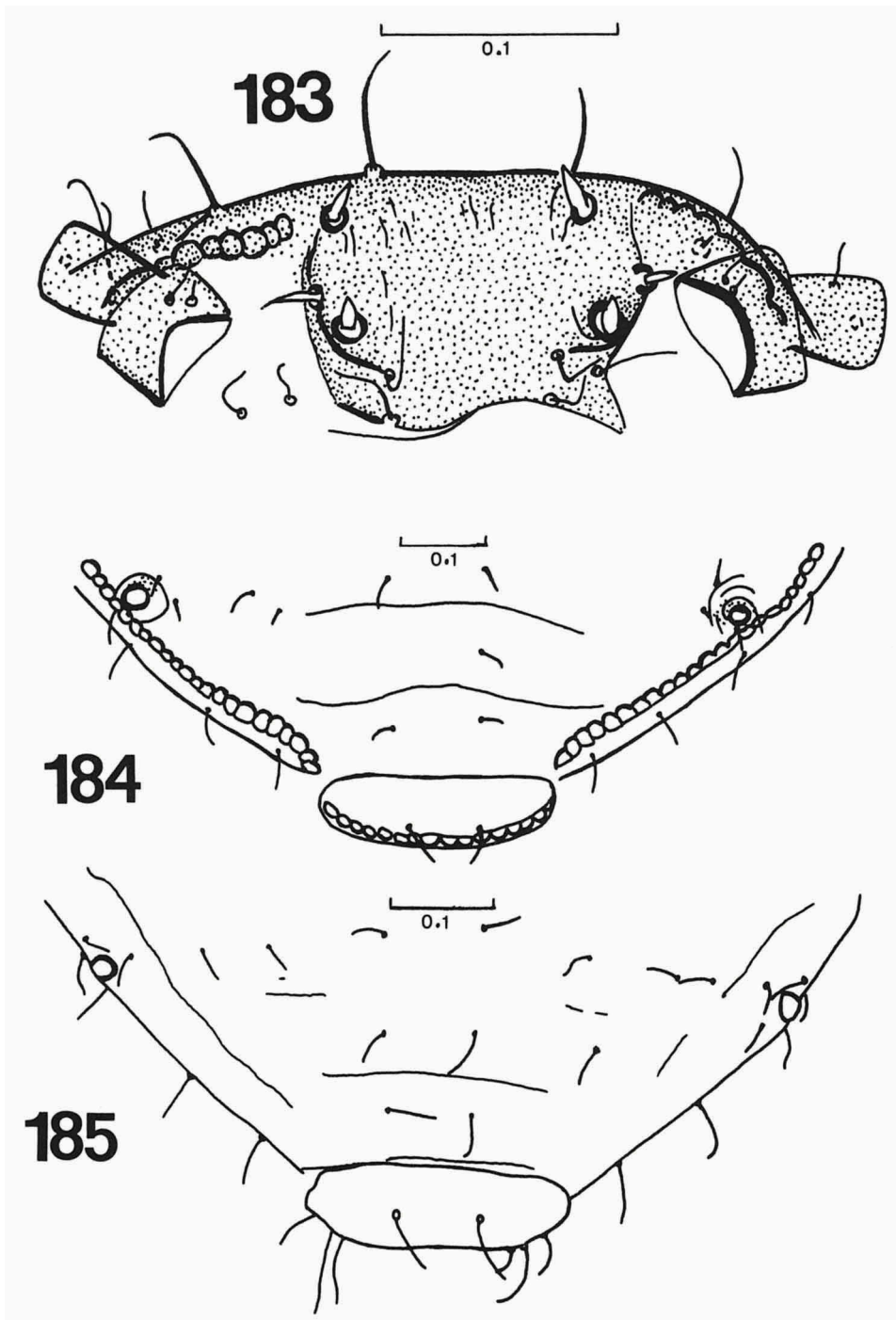

Figs. 183-185. *Cerataphis freycinetiae* Van der Goot, apterous viviparous ♀. Fig. 183, ventral side of the head of 'Geschwister der Geflügelten'. Fig. 184, distal part of the abdomen of a normal aptera, with wax glands located ventrally. Fig. 185, distal part of the abdomen of 'Geschwister der Geflügelten'.

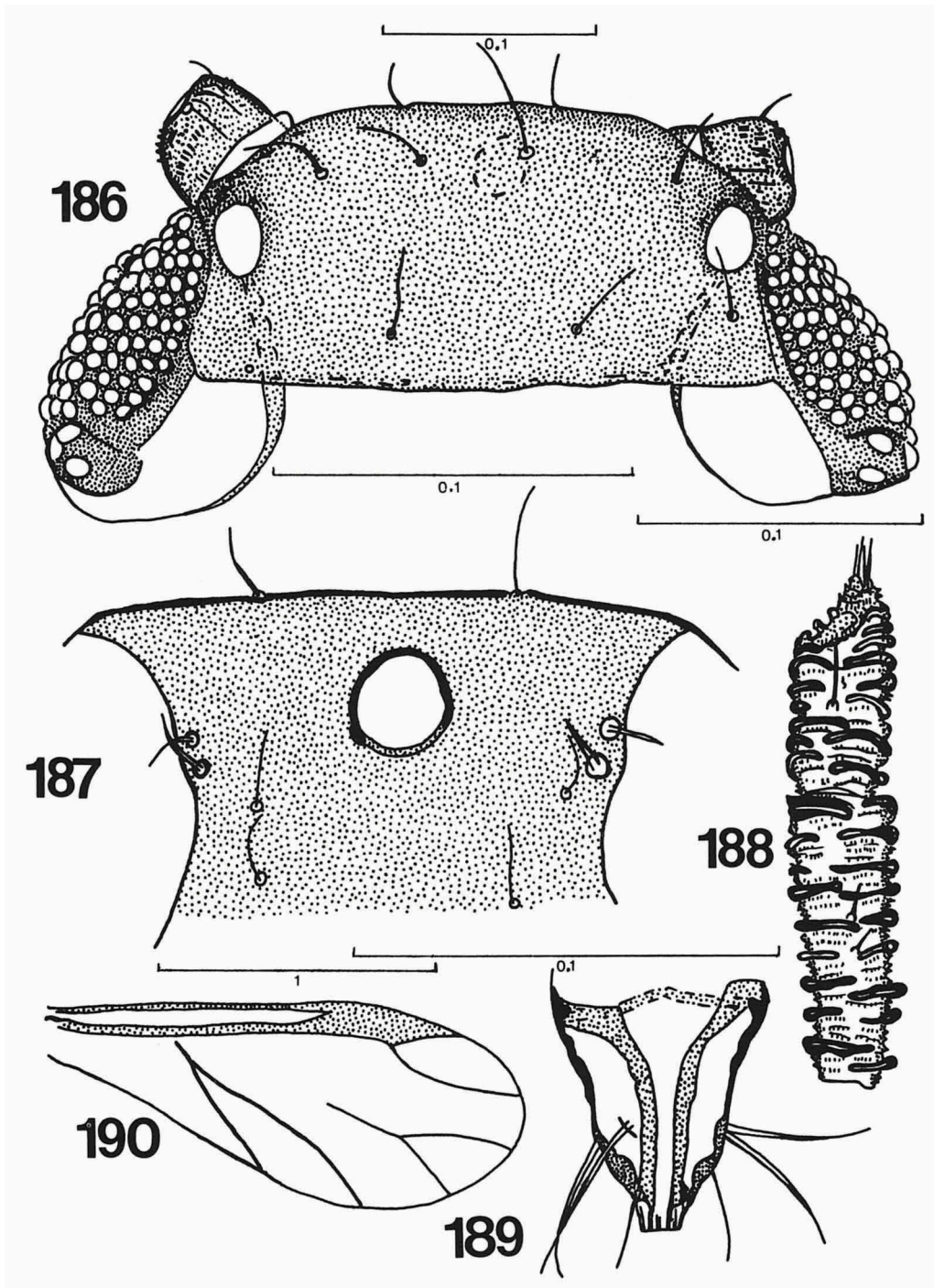

Figs. 186-190. *Cerataphis freycinetiae* Van der Goot, alate viviparous ♀. Fig. 186, dorsal side of the head. Fig. 187, ventral side of part of the head. Fig. 188, dorsal side of antennal segment V. Fig. 189, ultimate rostral segment. Fig. 190, fore wing.

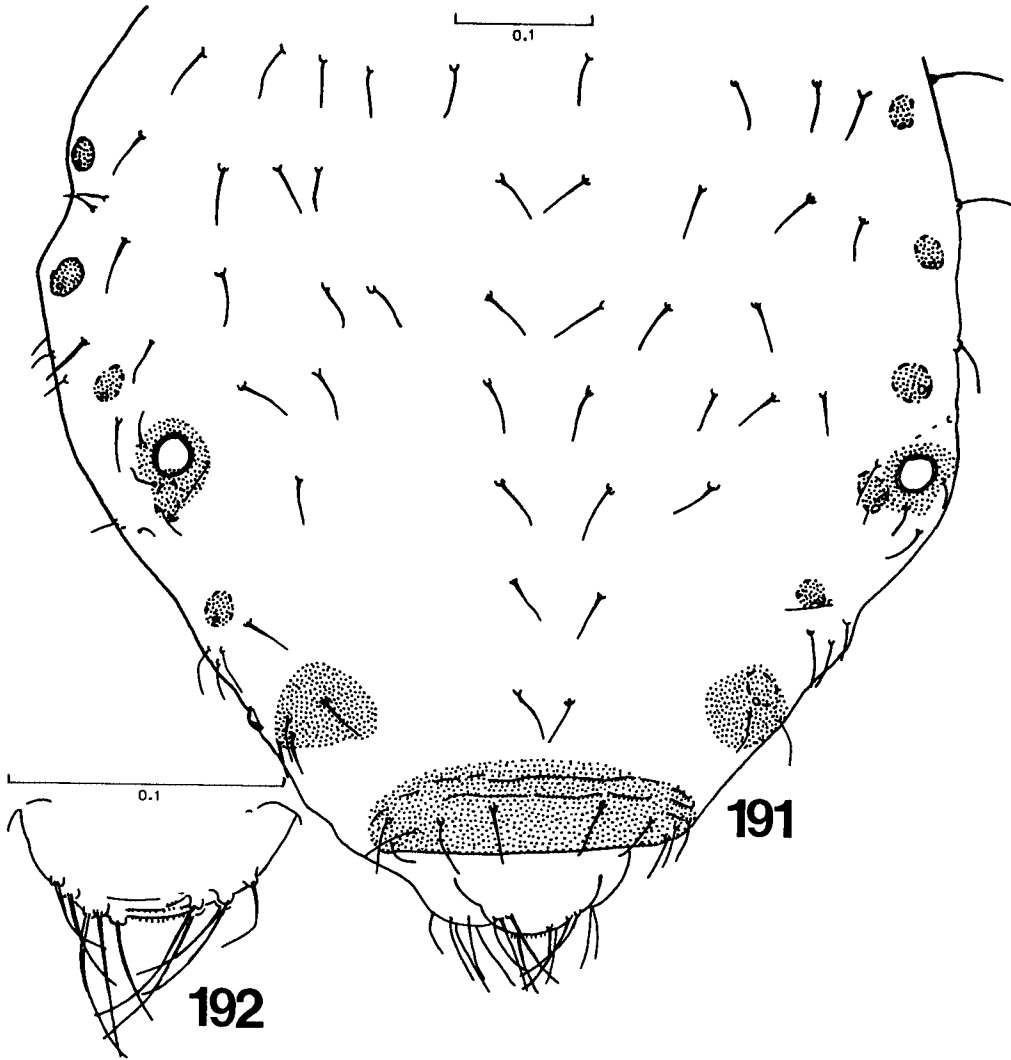

Figs. 191-192. *Cerataphis freycinetiae* Van der Goot, alate viviparous ♀. Fig. 191, dorsal sides of abdominal segments I-VIII. Fig. 192, cauda.

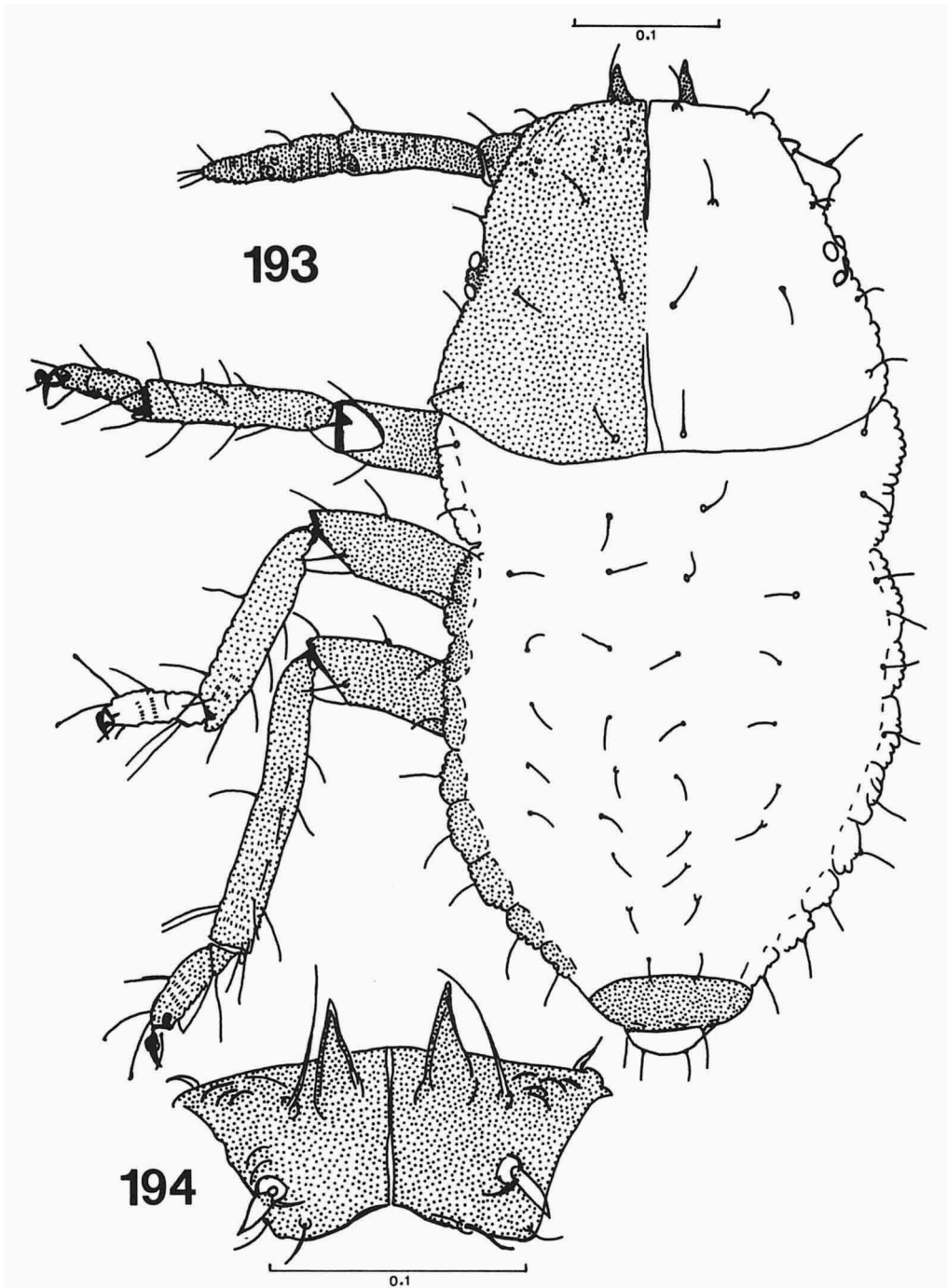

Figs. 193-194. *Cerataphis freycinetiae* Van der Goot, first stage larva, normal. Fig. 193, dorsal side of the body. Fig. 194, ventral side of part of the head.

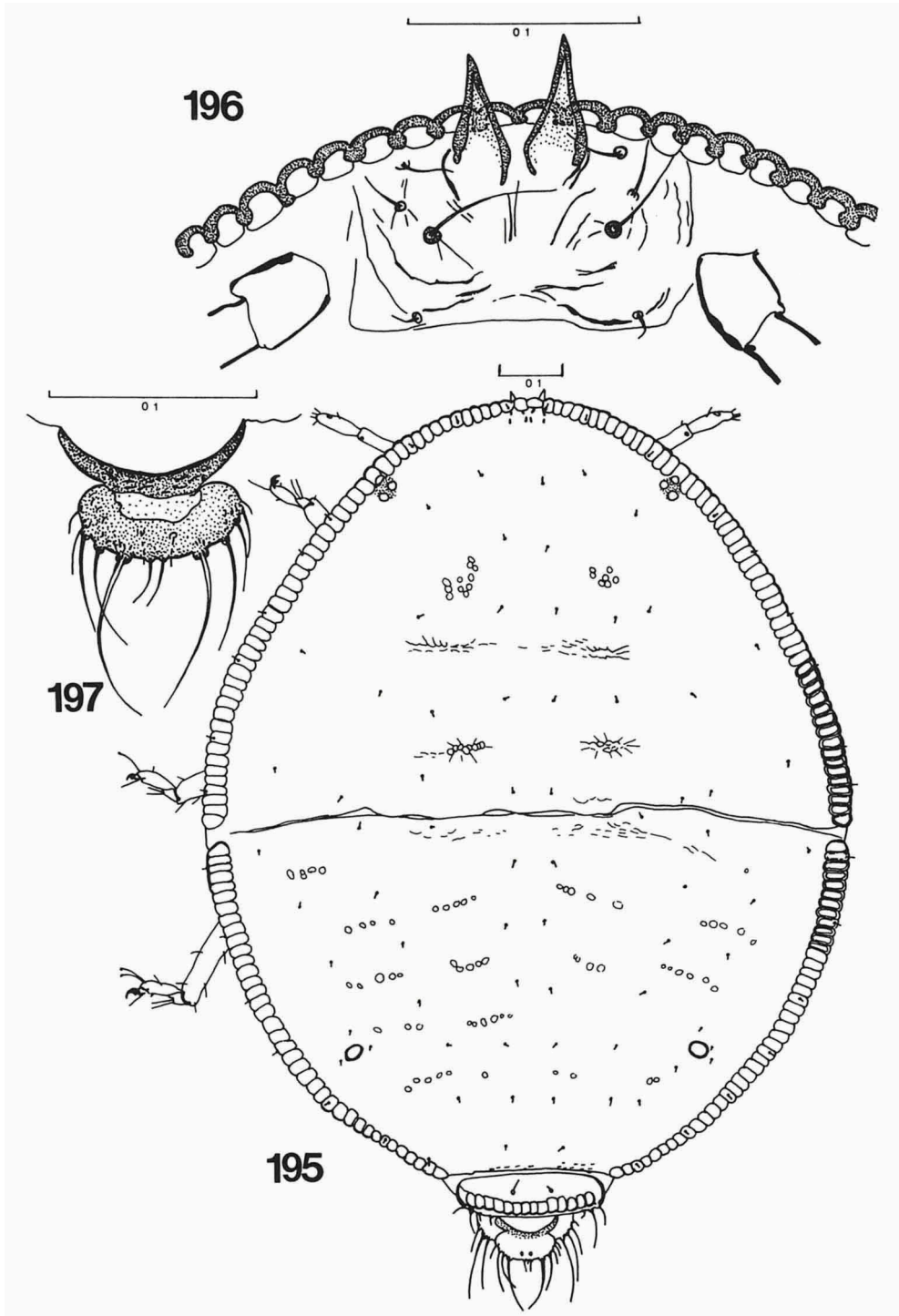

Figs. 195-197. *Cerataphis lataniae* (Boisduval), apterous viviparous ♀. Fig. 195, dorsal side of the body. Fig. 196, ventral anterior part of the head. Fig. 197, cauda.

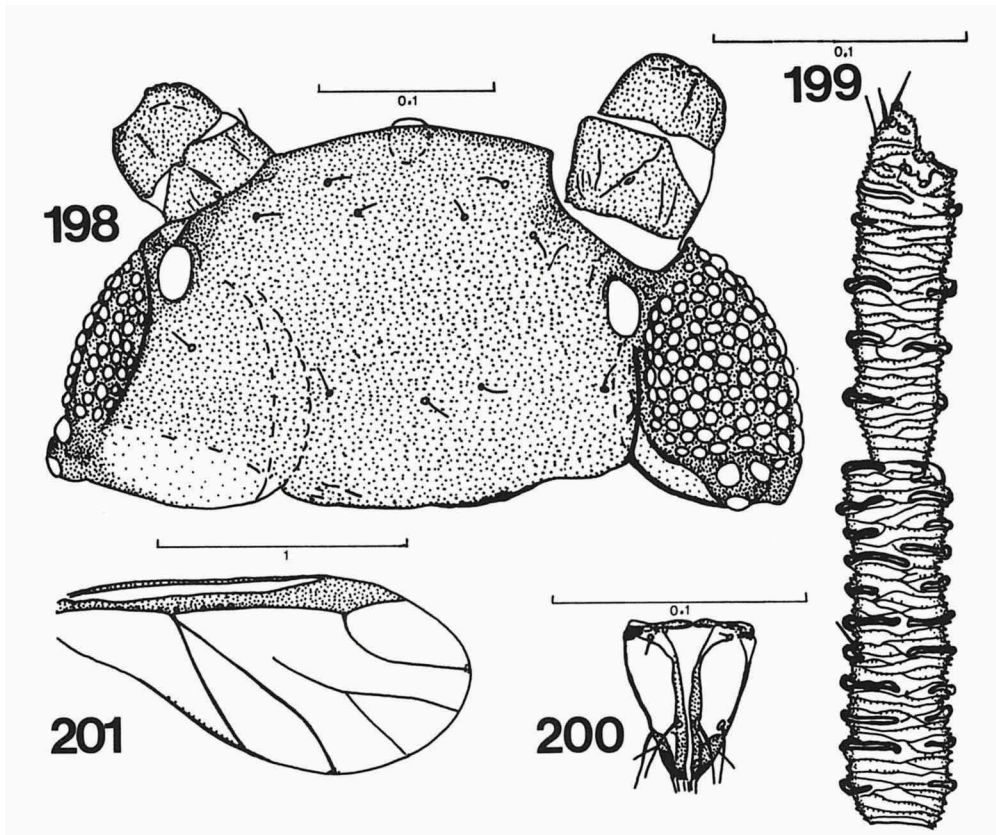

Figs. 198-201. *Cerataphis lataniae* (Boisduval), alate viviparous ♀. Fig. 198, dorsal side of the head. Fig. 199, dorsal sides of antennal segments IV and V. Fig. 200, ultimate rostral segment. Fig. 201, fore wing.

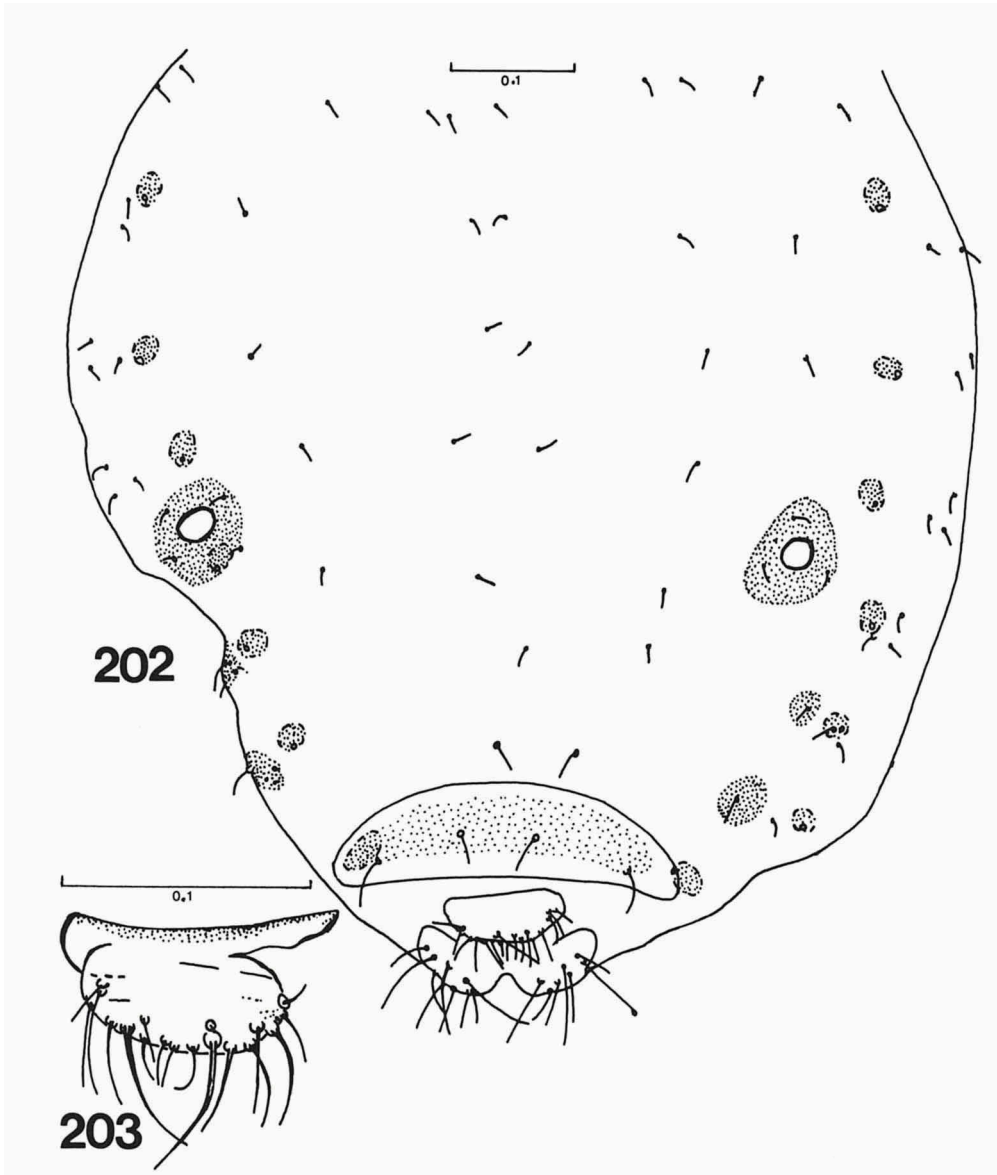

Figs. 202-203. *Cerataphis lataniae* (Boisduval), alate viviparous ♀. Fig. 202, dorsal sides of abdominal segments I-VIII. Fig. 203, cauda.

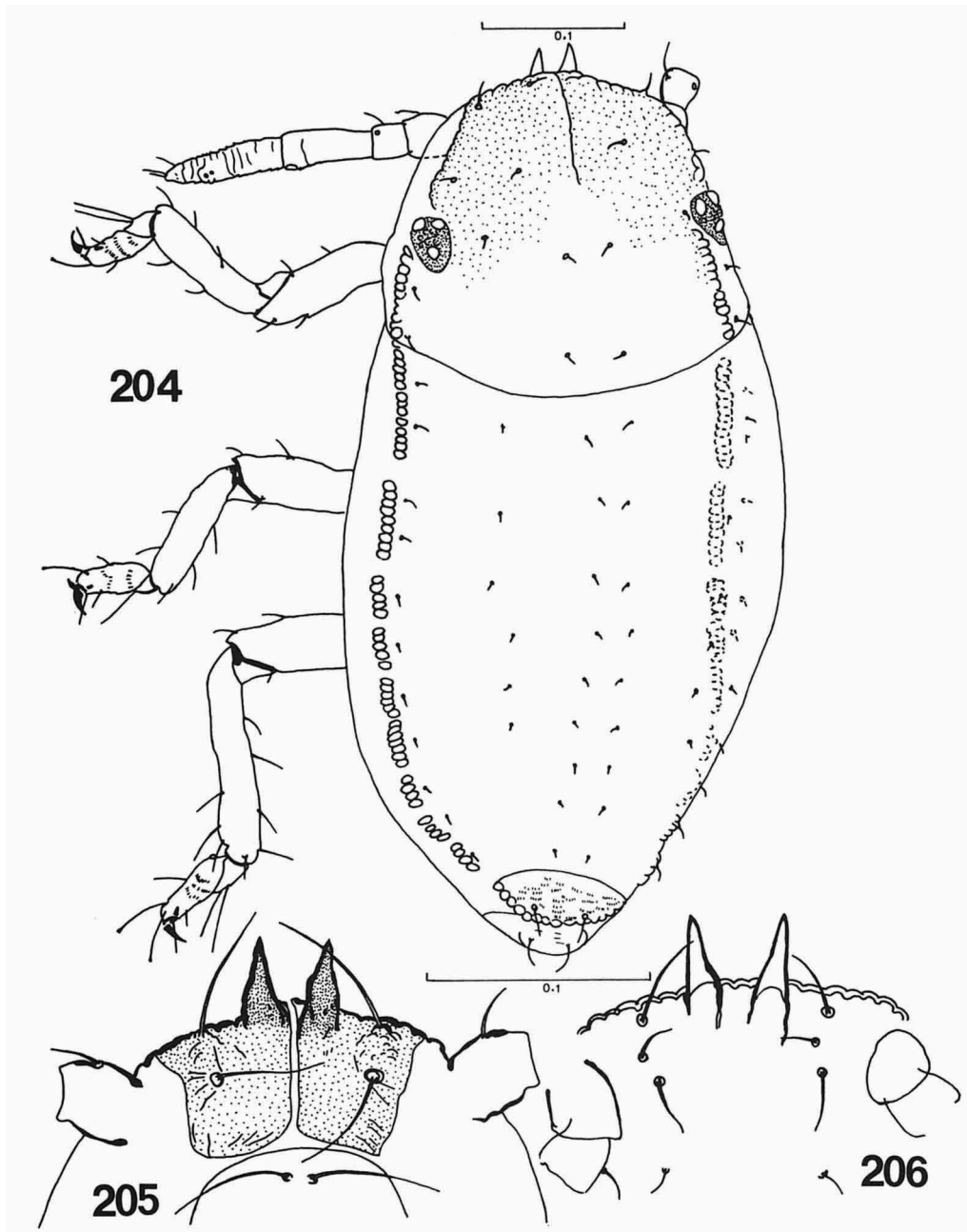

Figs. 204-206. *Cerataphis lataniae* (Boisduval), first stage larva, normal. Fig. 204, dorsal side of the head. Fig. 205, ventral side of the head. Fig. 206, second stage larva, ventral side of the head.



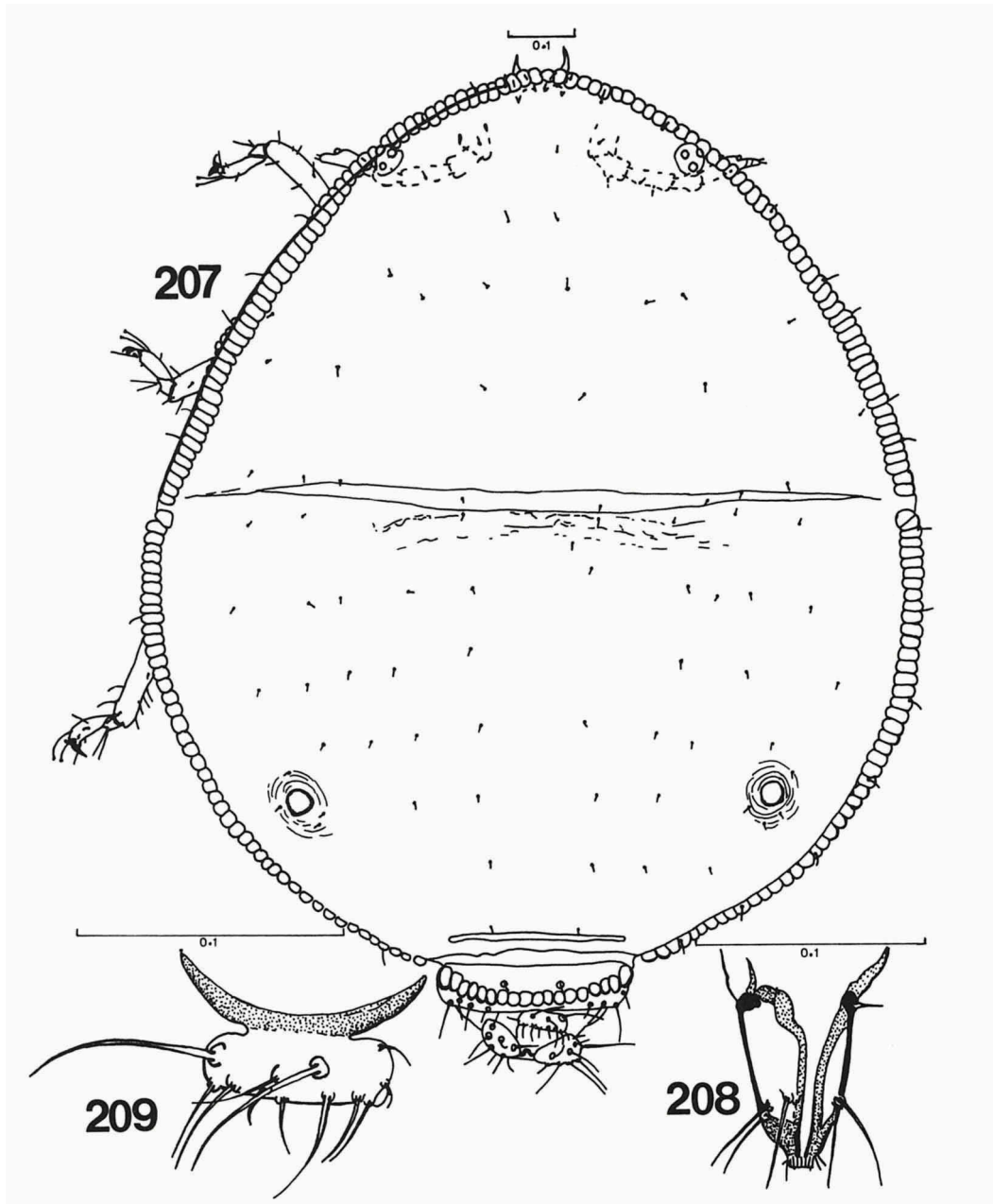

Figs. 207-209. *Cerataphis orchidearum* (Westwood), apterous viviparous ♀. Fig. 207, dorsal side of the body. Fig. 208, ultimate rostral segment. Fig. 209, cauda.

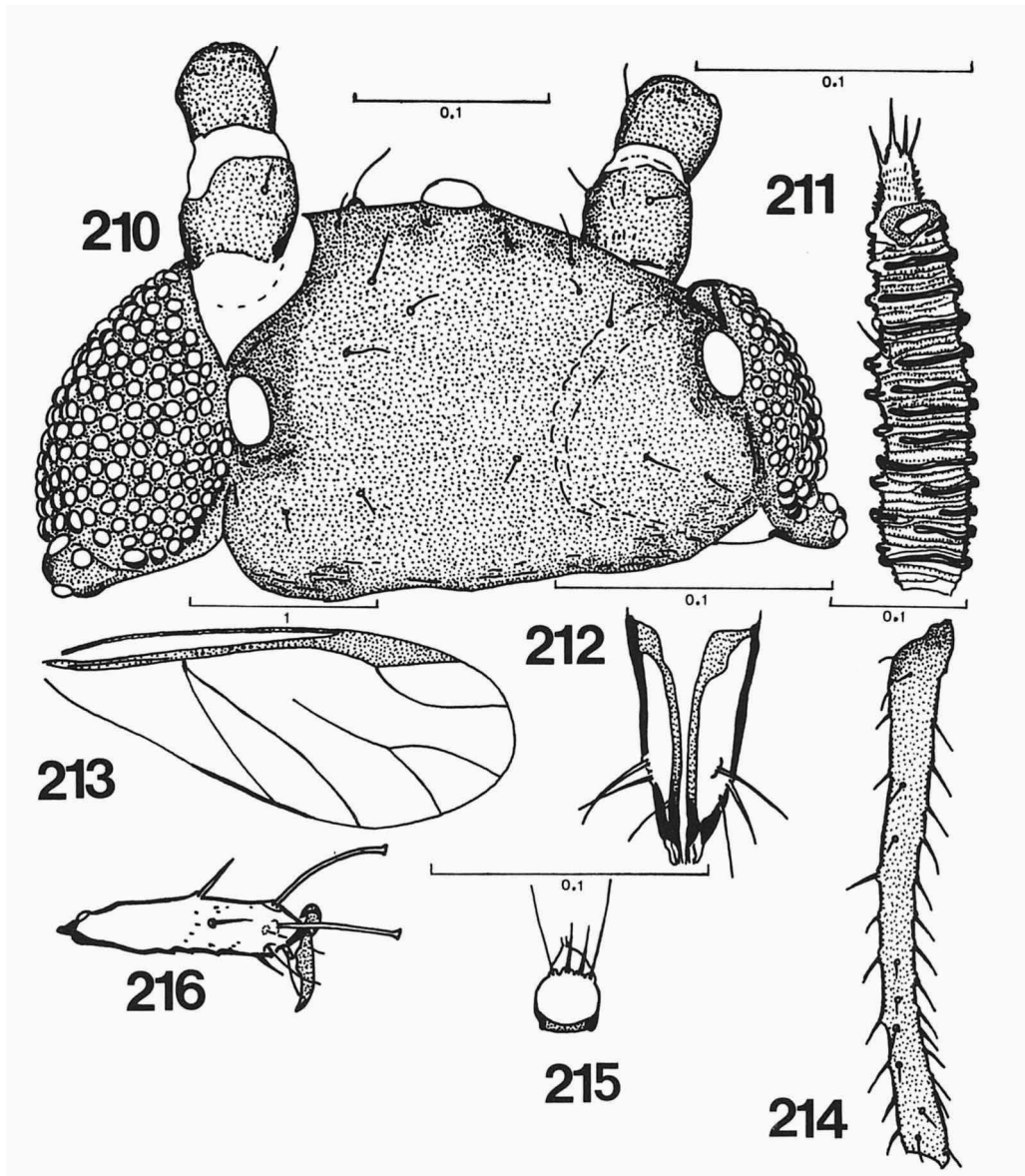

Figs. 210-216. *Cerataphis orchidearum* (Westwood), alate viviparous ♀. Fig. 210, dorsal side of the head. Fig. 211, dorsal side of antennal segment V. Fig. 212, ultimate rostral segment. Fig. 213, fore wing. Fig. 214, tibia of the foreleg. Fig. 215, first tarsal segment of the foreleg. Fig. 216, second tarsal segment of the hind leg.

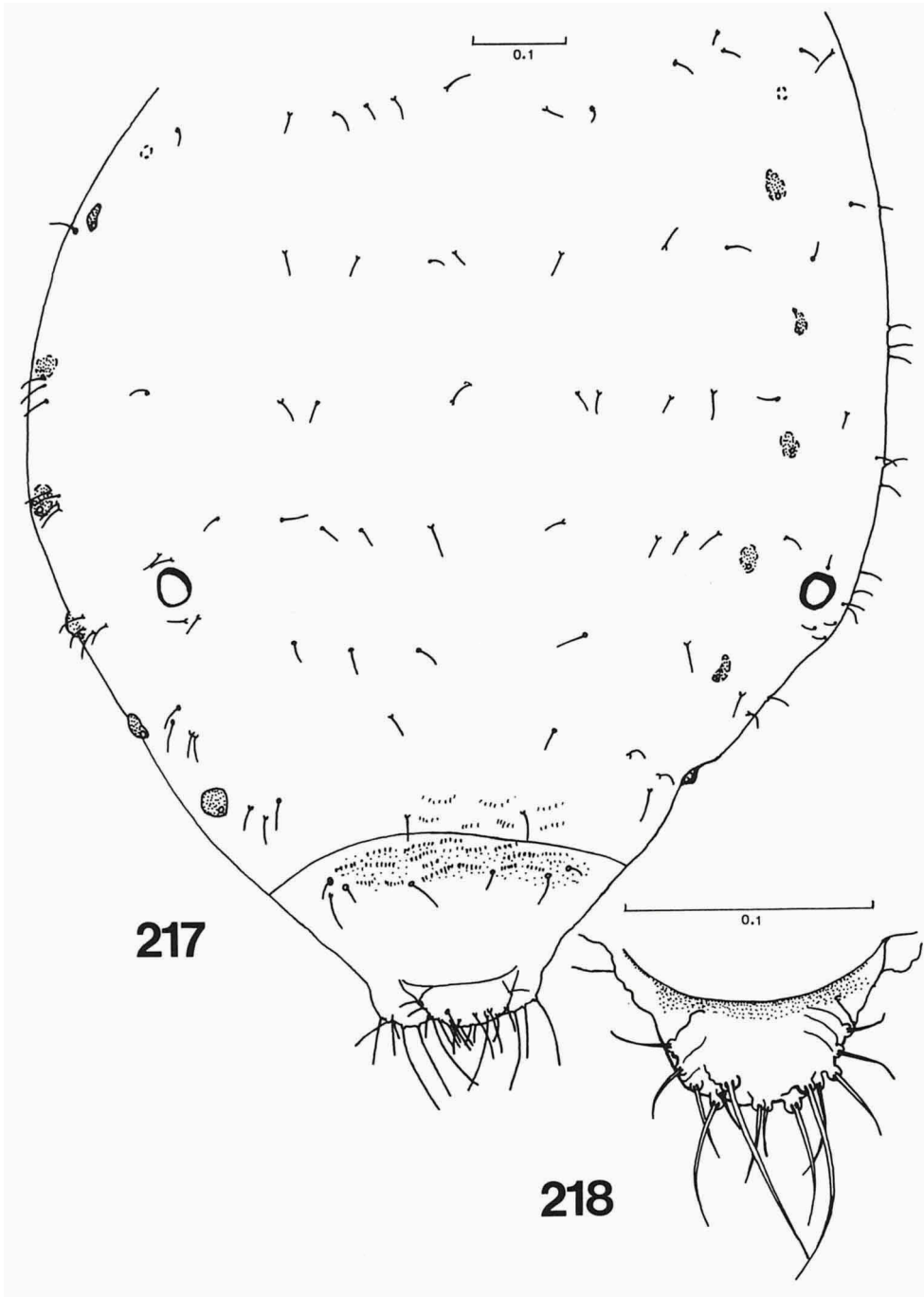

Figs. 217-218. *Cerataphis orchidearum* (Westwood), alate viviparous ♀. Fig. 217, dorsal sides of abdominal segments I-VIII. Fig. 218, cauda.

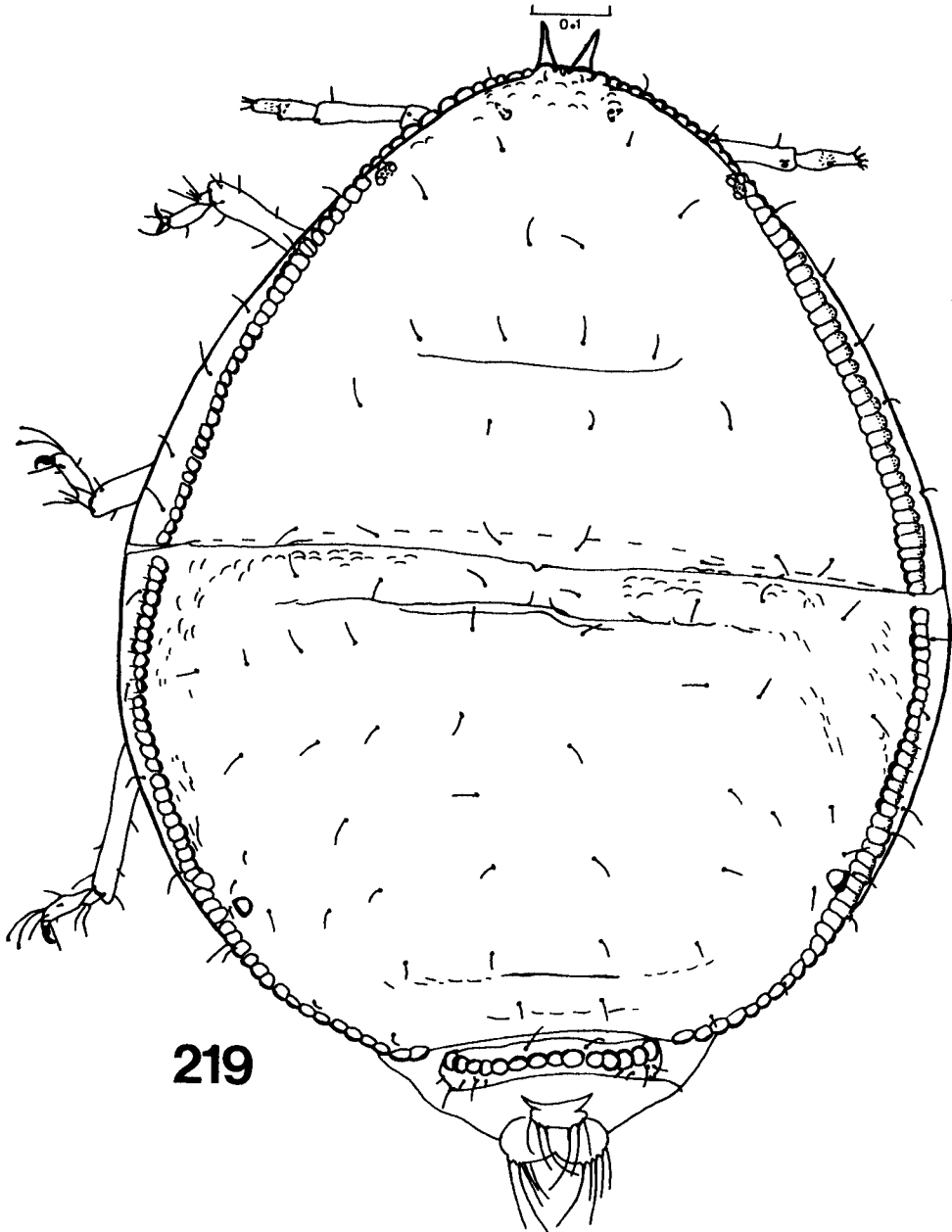
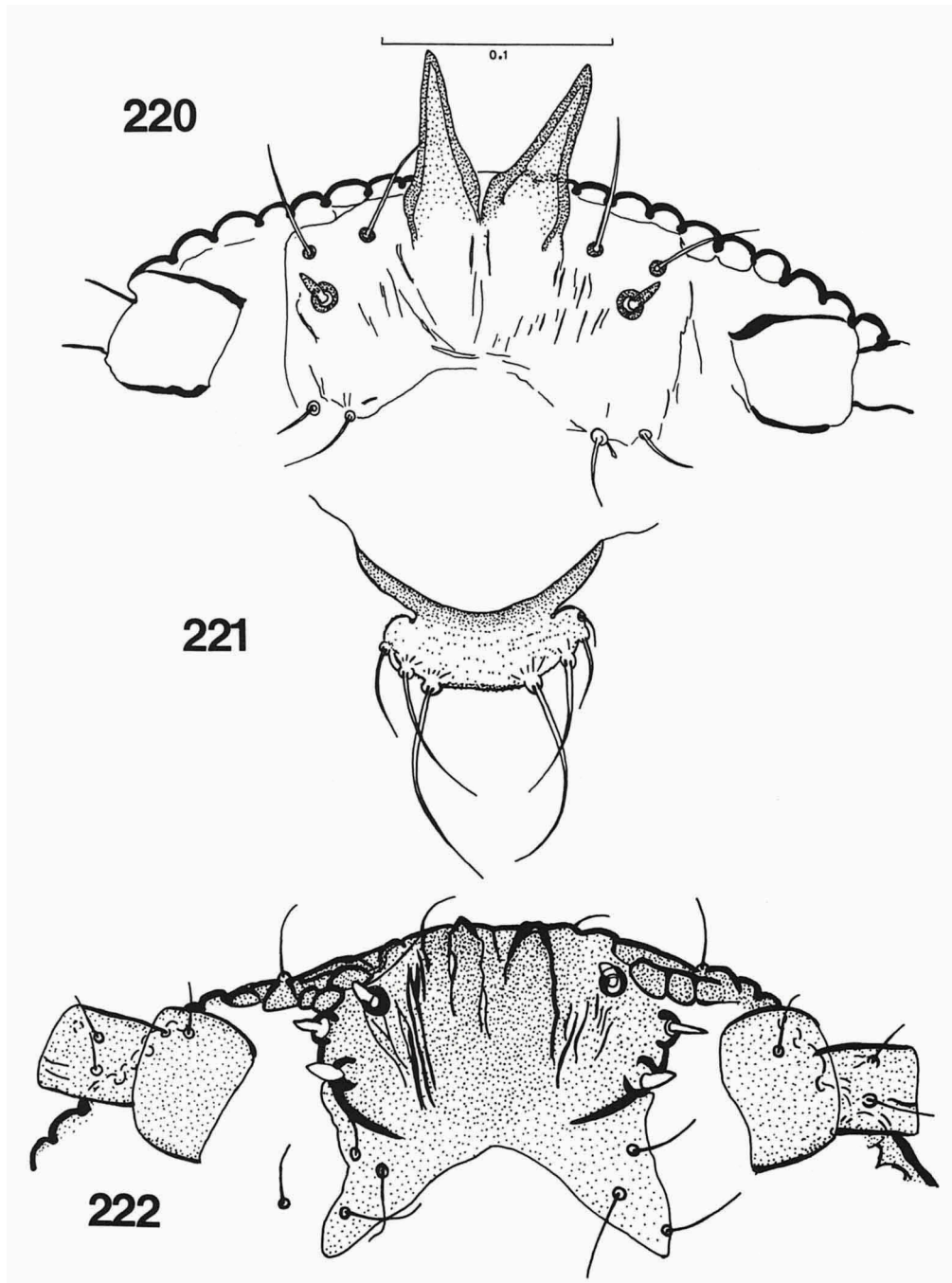
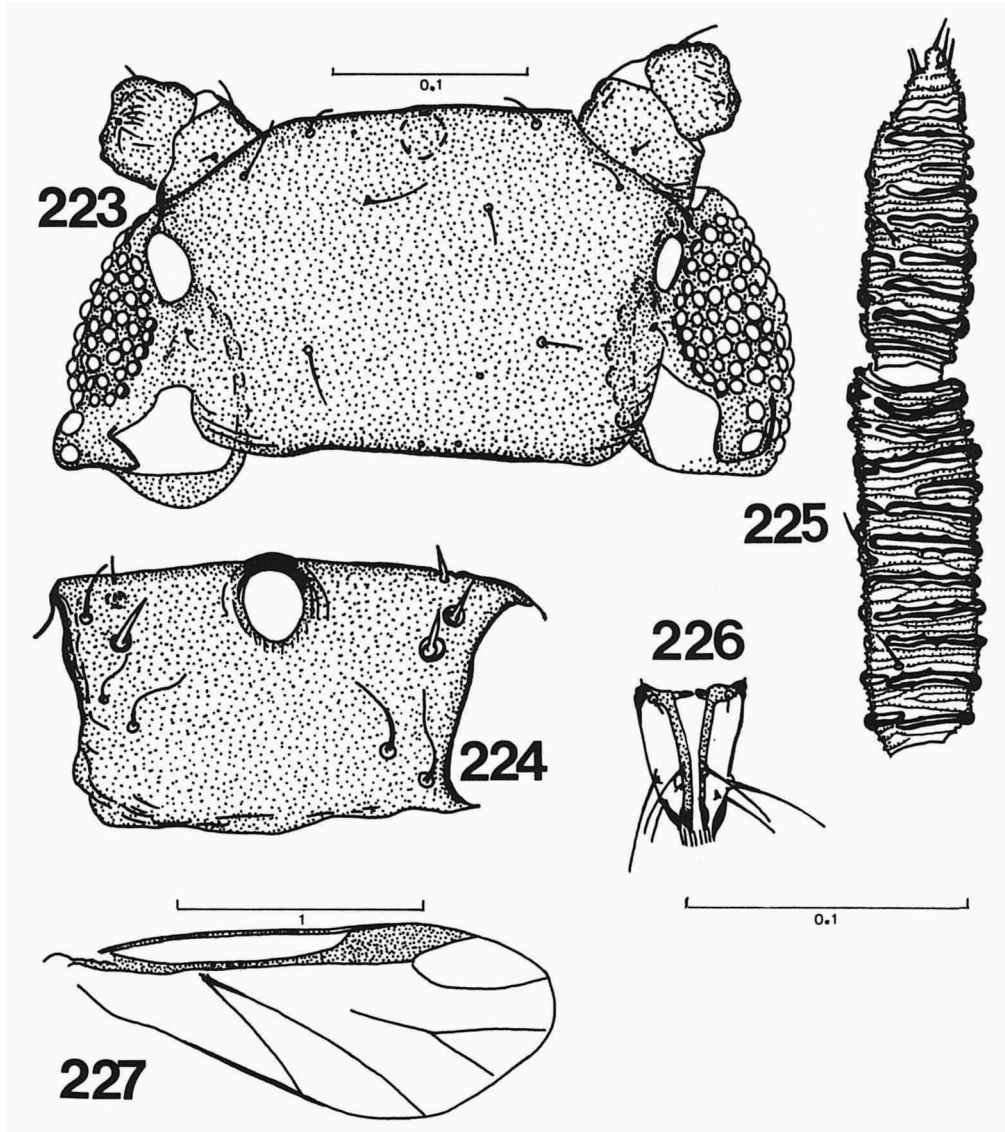

Fig. 219. *Cerataphis palmae* (Ghesquière), apterous viviparous ♀, dorsal side of the body.



Figs. 220-222. *Cerataphis palmae* (Ghesquière), apterous viviparous ♀. Fig. 220, ventral side of the head. Fig. 221, cauda. Fig. 222, 'Geschwister der Geflügelten', ventral side of the head.



Figs. 223-227. *Cerataphis palmae* (Ghesquière), alate viviparous ♀. Fig. 223, dorsal side of the head. Fig. 224, ventral side of part of the head. Fig. 225, dorsal sides of antennal segments IV-V. Fig. 226, ultimate rostral segment. Fig. 227, fore wing. Scale line 0.1 below to figs. 224-226.

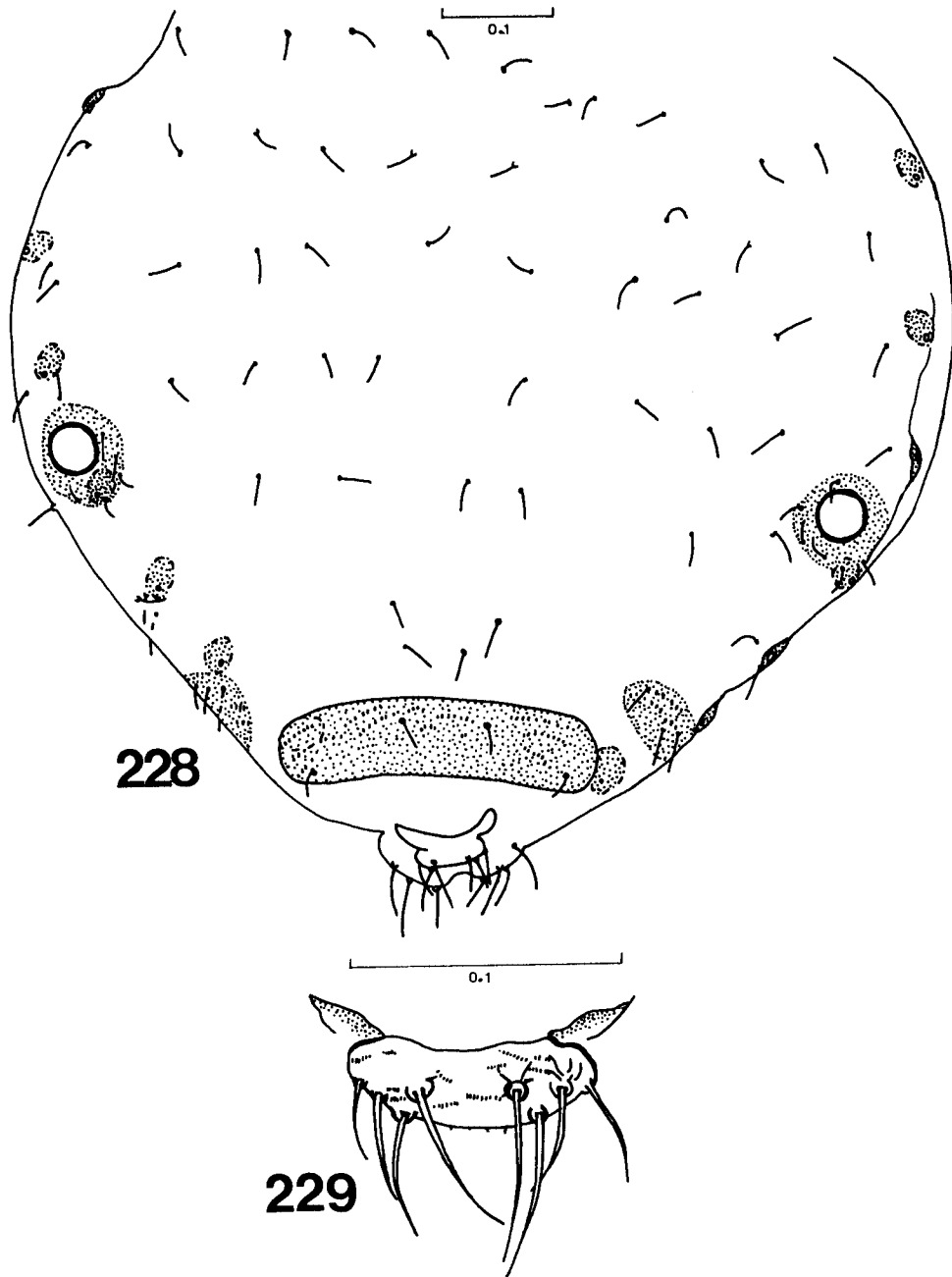

Figs. 228-229. *Cerataphis palmae* (Ghesquière), alate viviparous ♀. Fig. 228, dorsal sides of abdominal segments I-VIII. Fig. 229, cauda.

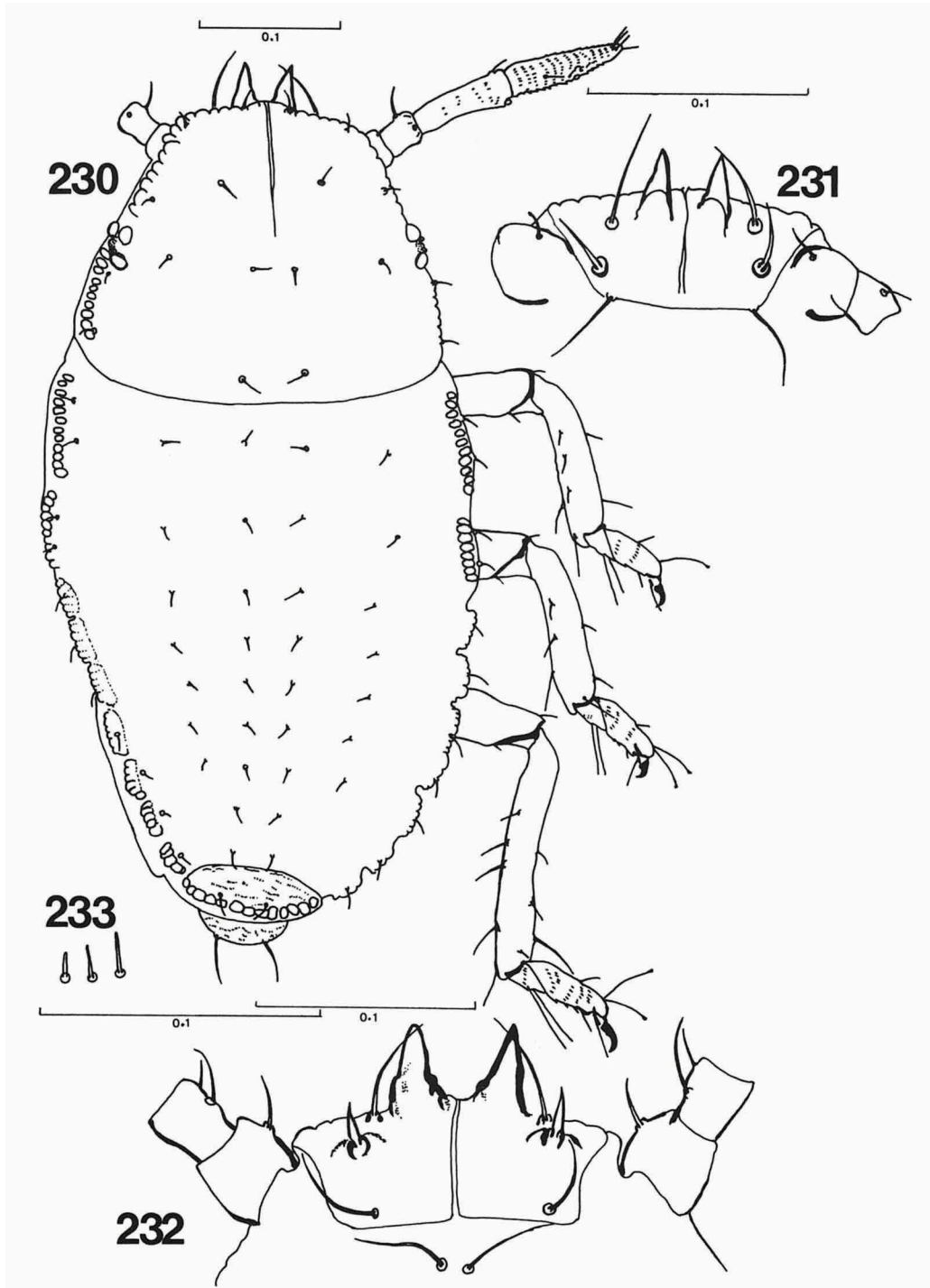

Figs. 230-233. *Cerataphis palmae* (Ghesquière), first stage larva. Fig. 230, dorsal side of the body, of a specimen with short hairs, and with sometimes non-acute tips. Figs. 231, 232, ventral sides of two heads. Figs. 233, three blunt hairs dorsally on the body.



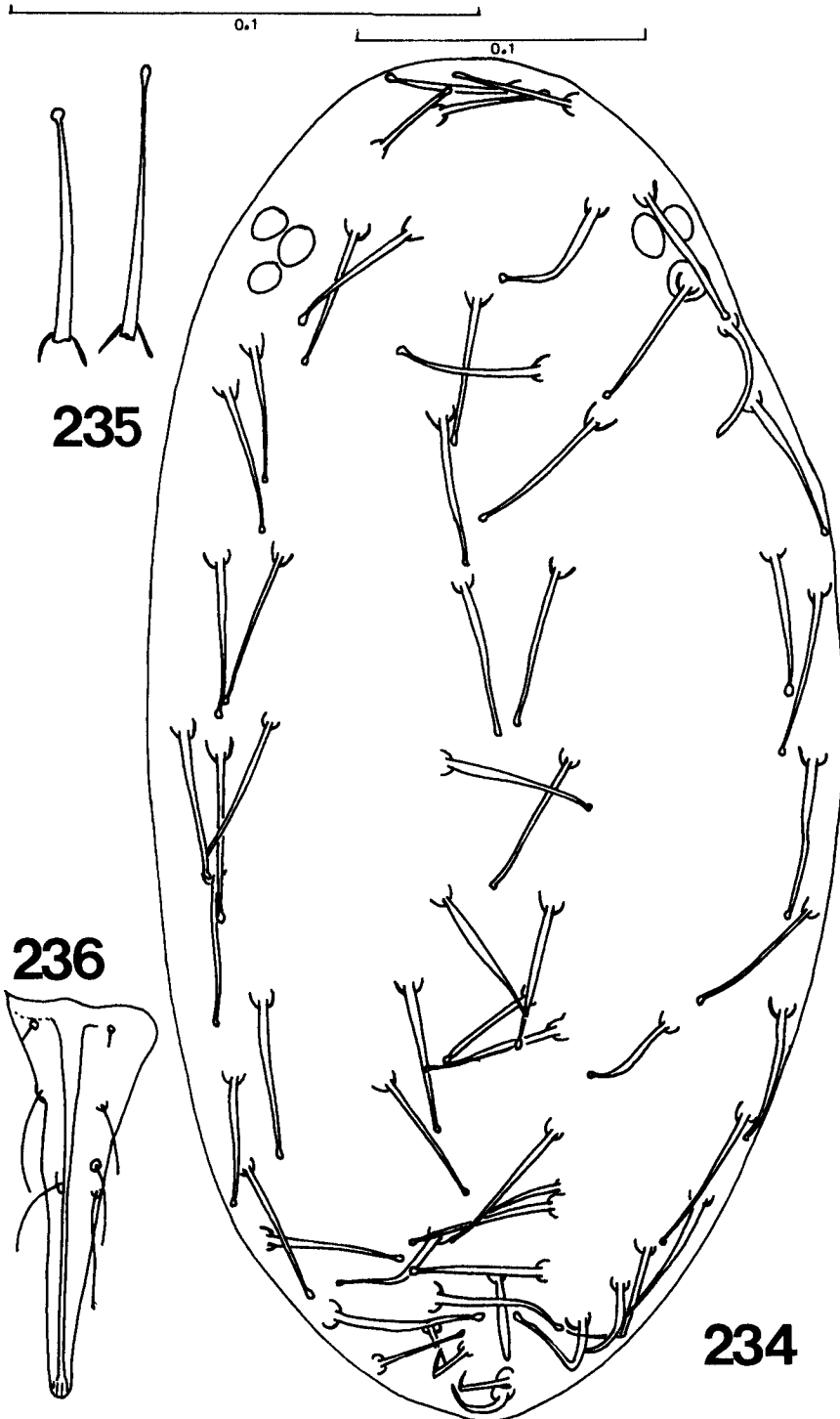

Figs. 234-236. *Cerataphis palmae* (Ghesquière), embryo inside alate viviparous ♀. Fig. 234, dorsal side of the body. Fig. 235, hair dorsally of the head (left), and of the abdomen (right). Fig. 236, ultimate rostral segment. Longest 0.1 scale line to figs. 235-236.

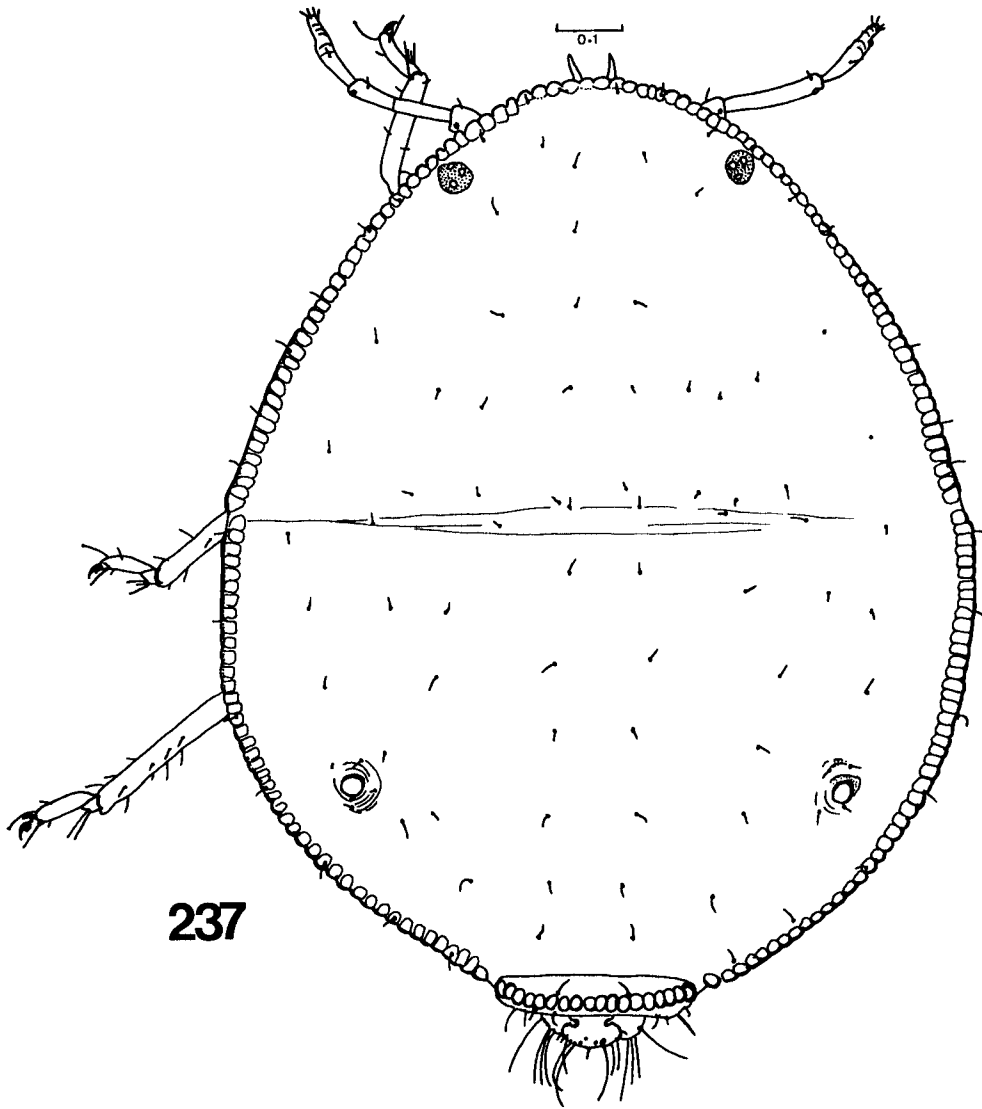

Figs. 237. *Cerataphis pothophila* spec. nov., apterous viviparous ♀, dorsal side of the body.

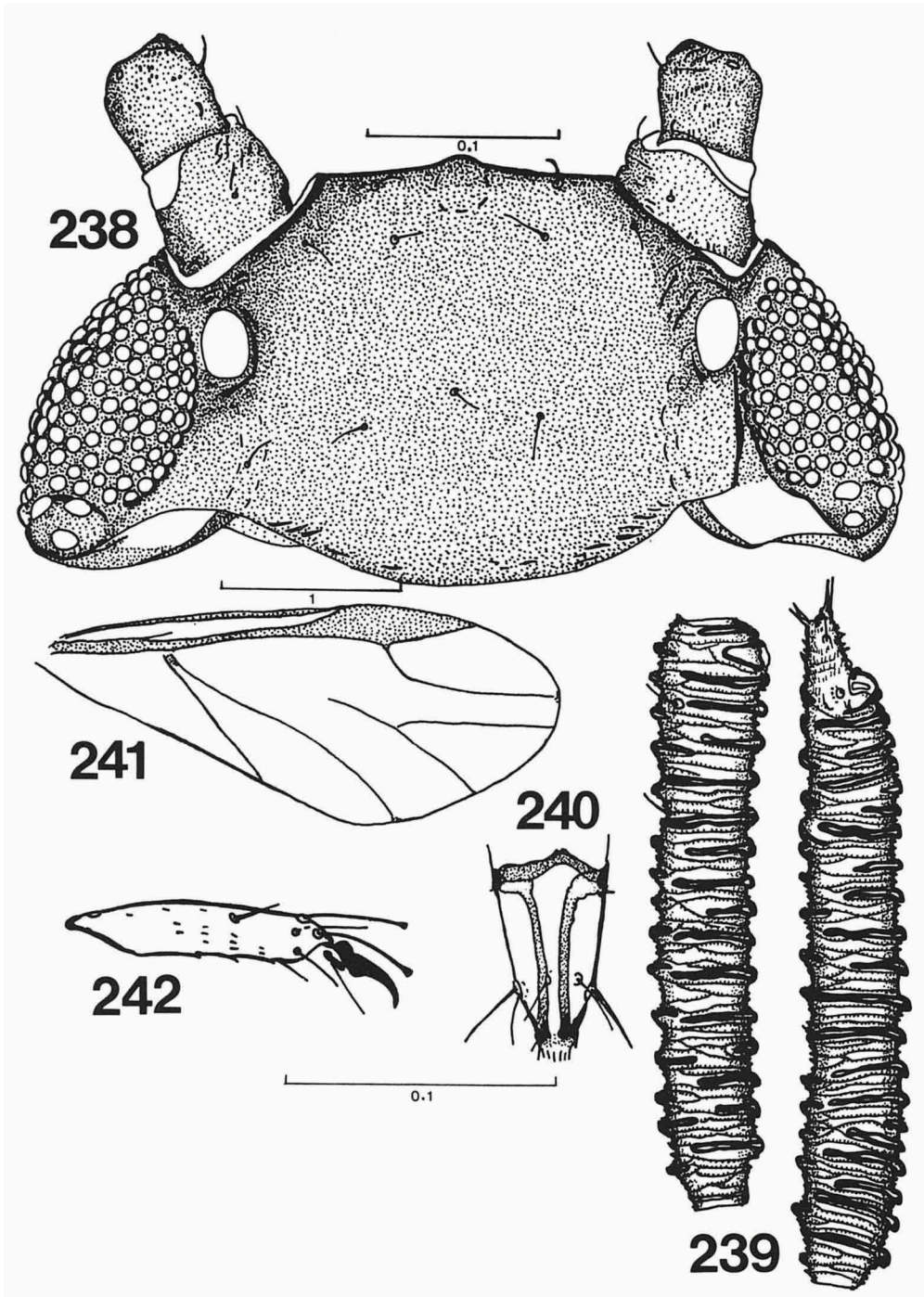

Figs. 238-242. *Cerataphis pothophila* spec. nov., alate viviparous ♀. Fig. 238, dorsal side of the head. Fig. 239, dorsal sides of antennal segments IV and V. Fig. 240, ultimate rostral segment. Fig. 241, fore wing. Fig. 242, second tarsal segment of the hind leg.

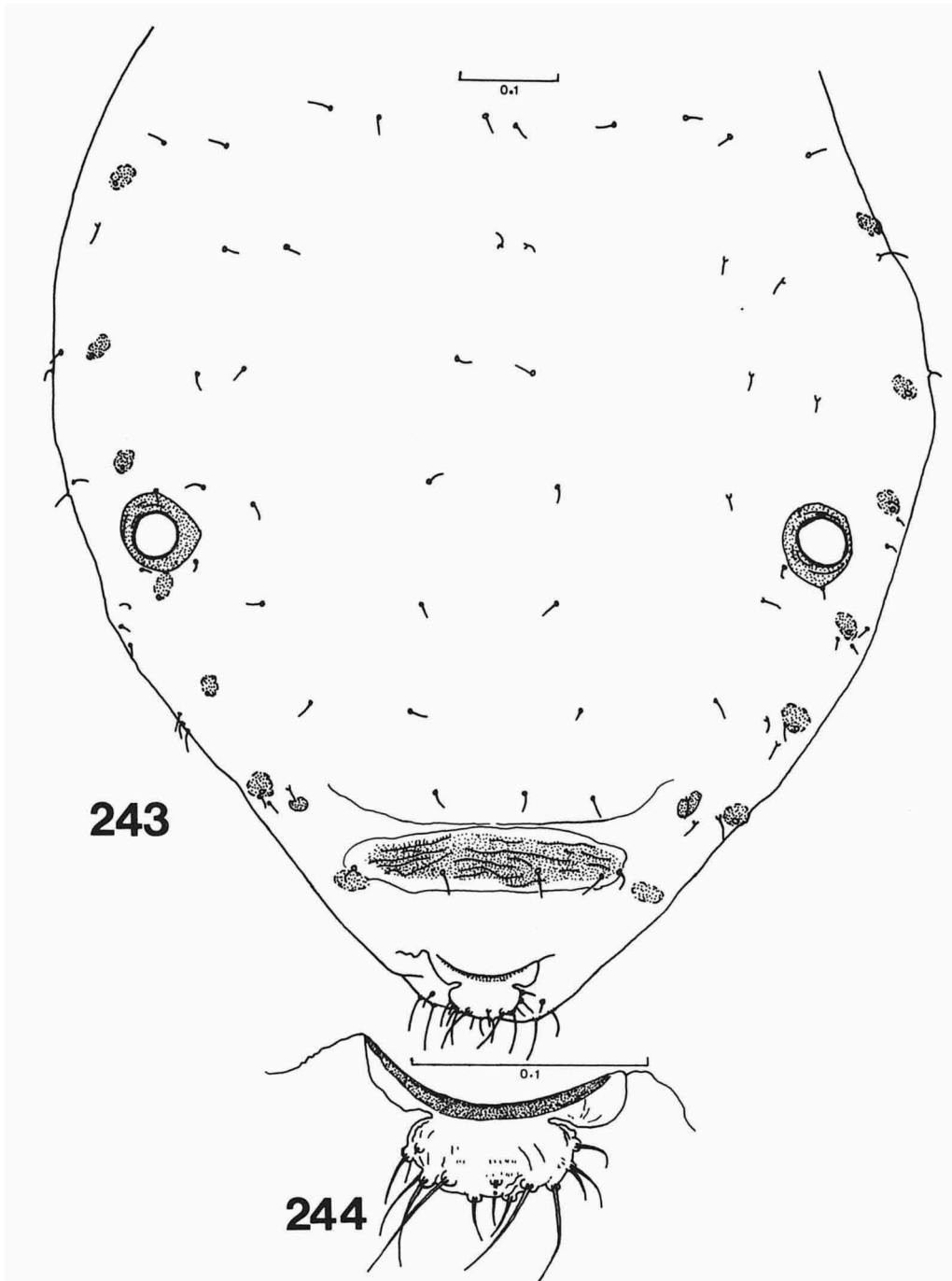

Figs. 243-244. *Cerataphis pothophila* spec. nov., alate viviparous ♀. Fig. 243, dorsal sides of abdominal segments I-VIII. Fig. 244, cauda.

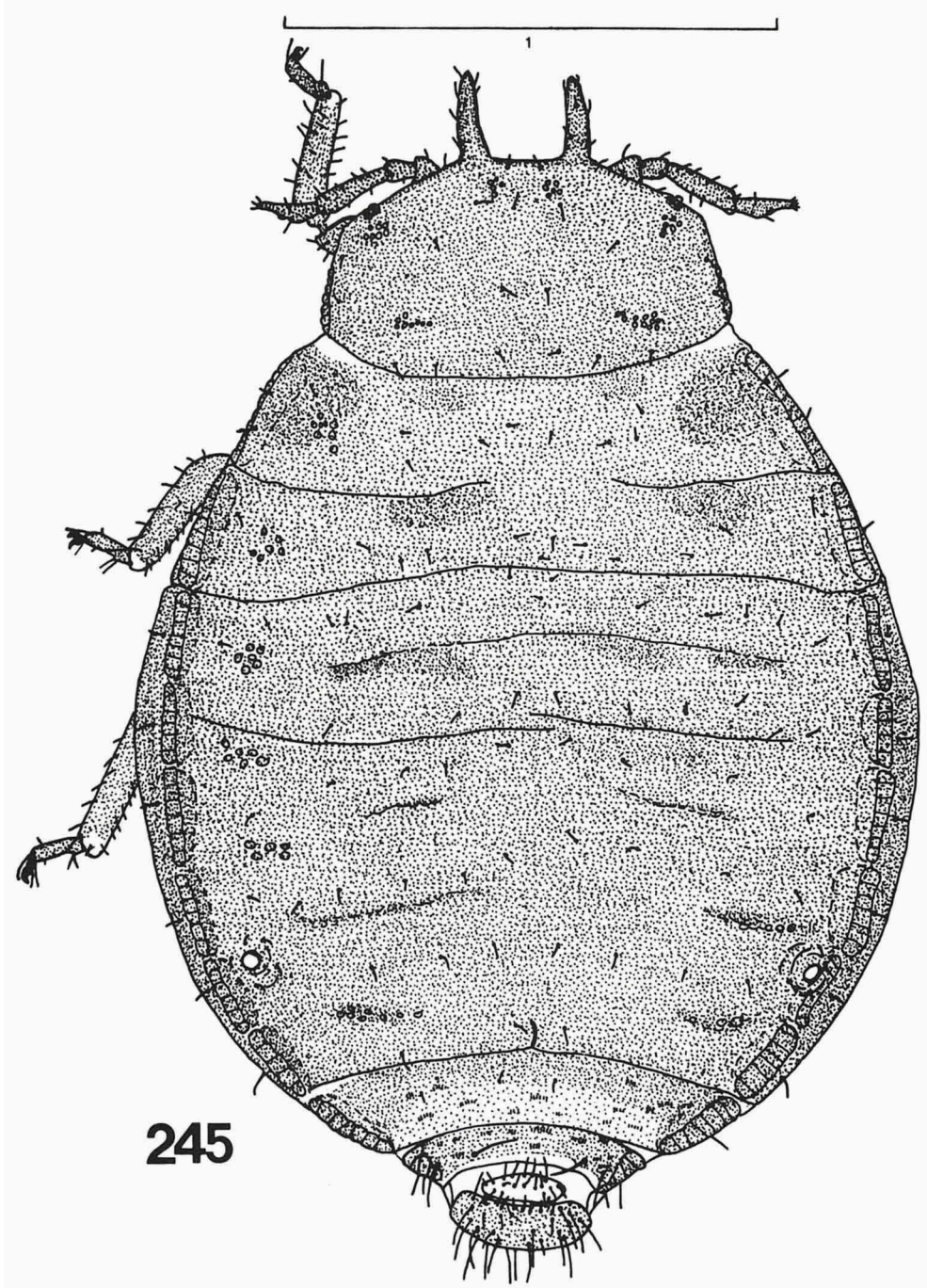
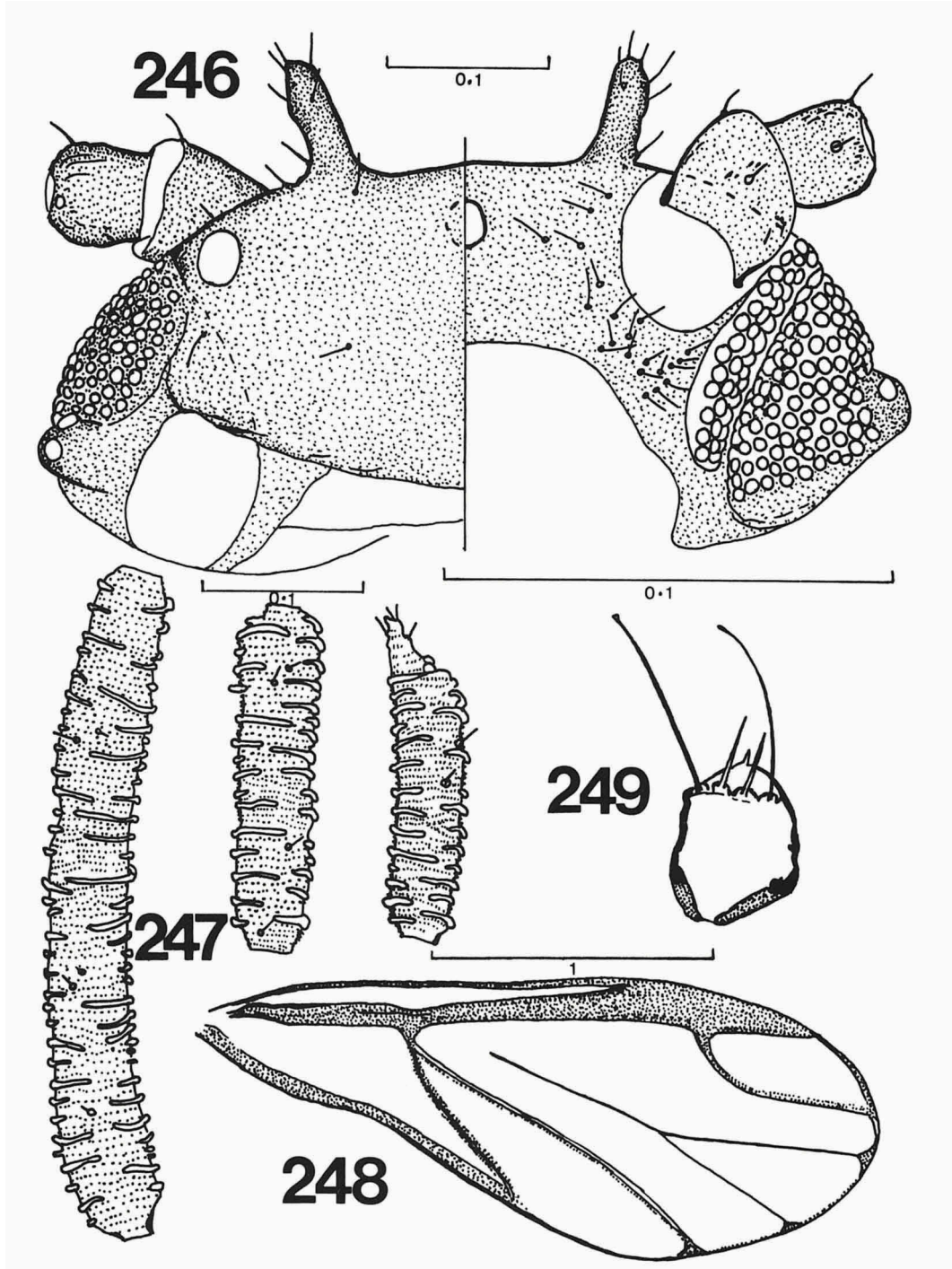

Fig. 245. *Ceratoglyphina bambusae* Van der Goot, apterous viviparous ♀, dorsal side of the body.



Figs. 246-249. *Ceratoglyphina bambusae* Van der Goot, alate viviparous ♀. Fig. 246, dorsal (left) and ventral (right) side of the head. Fig. 247, dorsal sides of antennal segments III-V. Fig. 248, fore wing. Fig. 249, first tarsal segment of the foreleg.

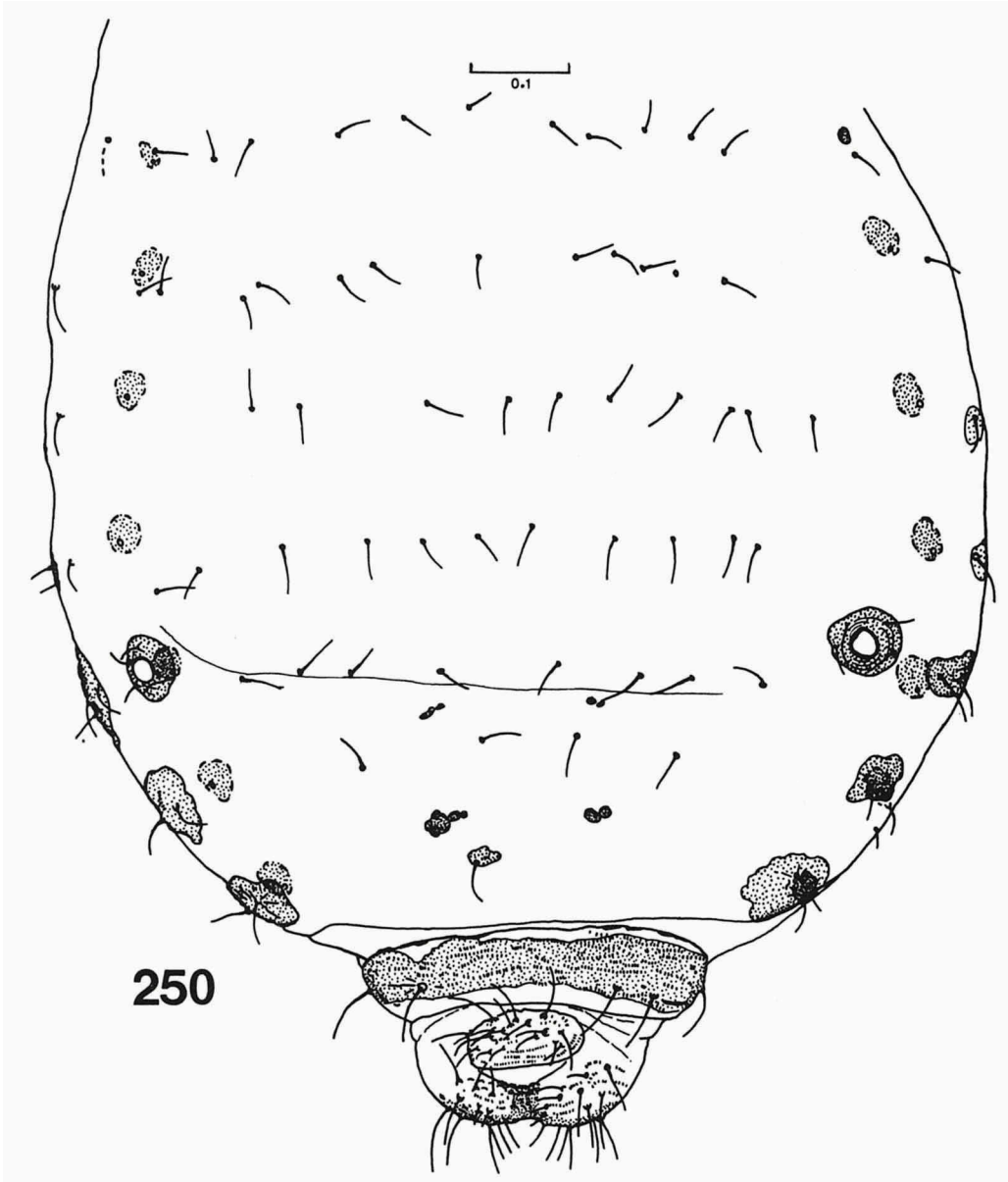

Fig. 250. *Ceratoglyphina bambusae* Van der Goot, alate viviparous ♀, dorsal sides of abdominal segments I-VIII.

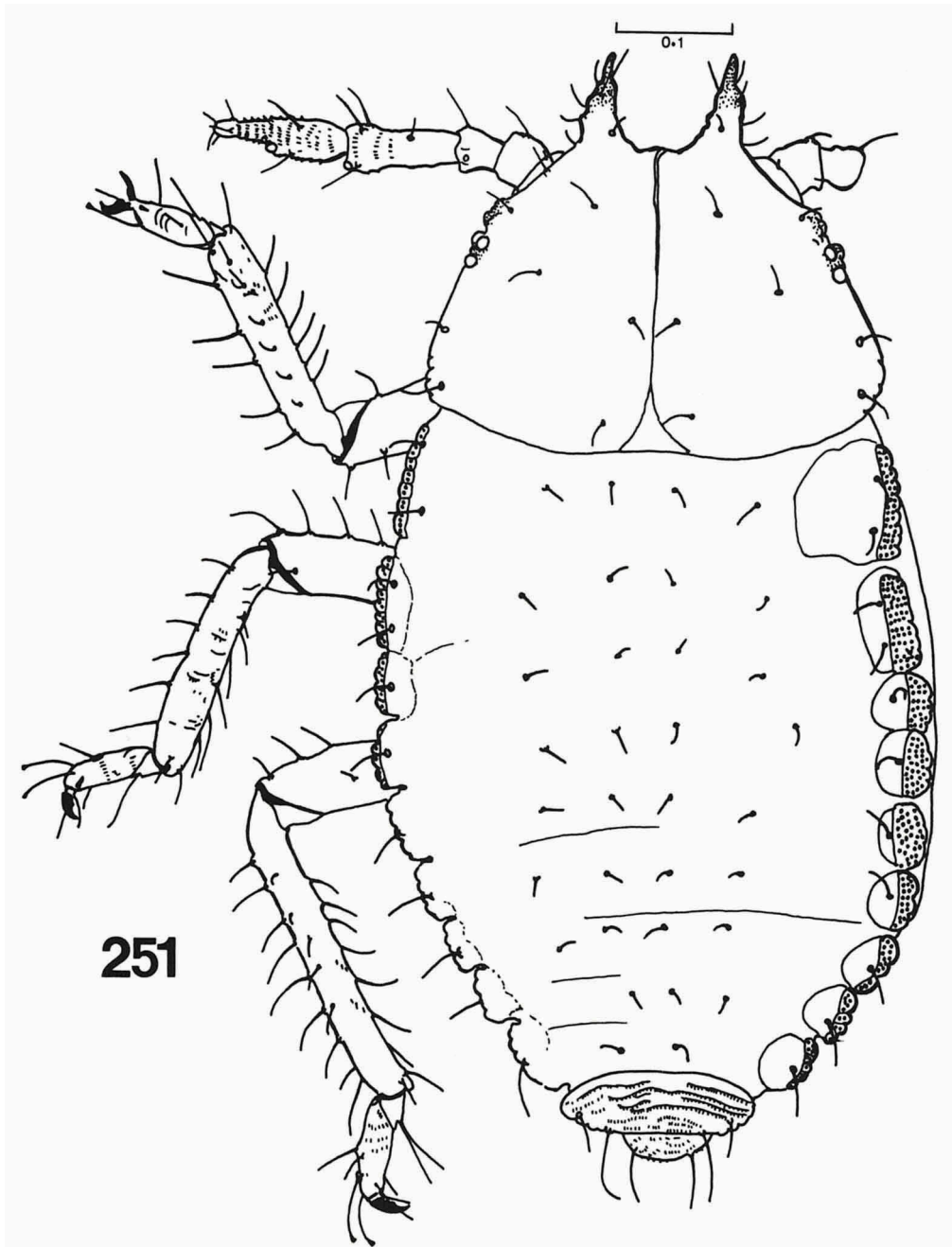

Fig. 251. *Ceratoglyphina bambusae* Van der Goot, first stage larva, normal, dorsal side of the body.



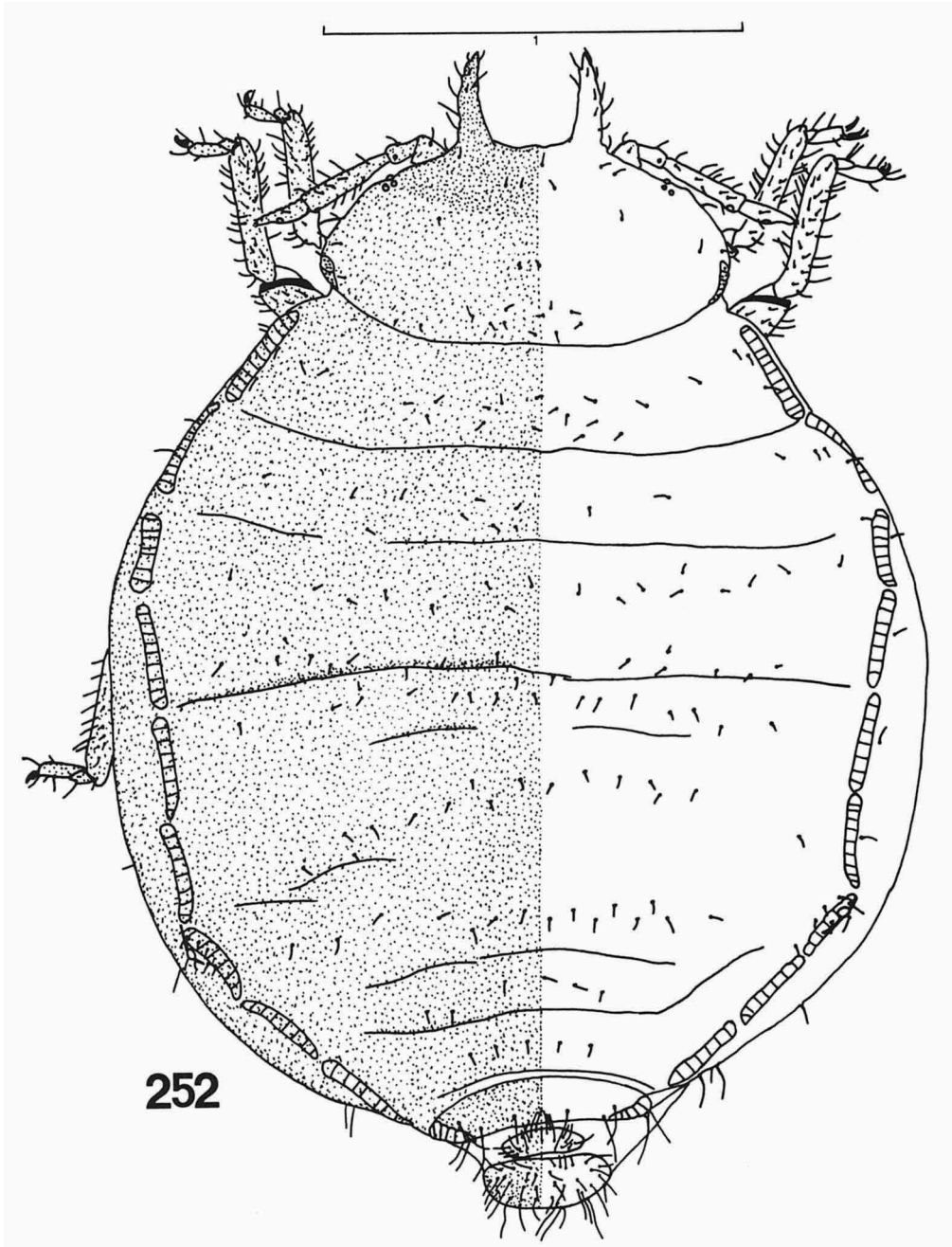
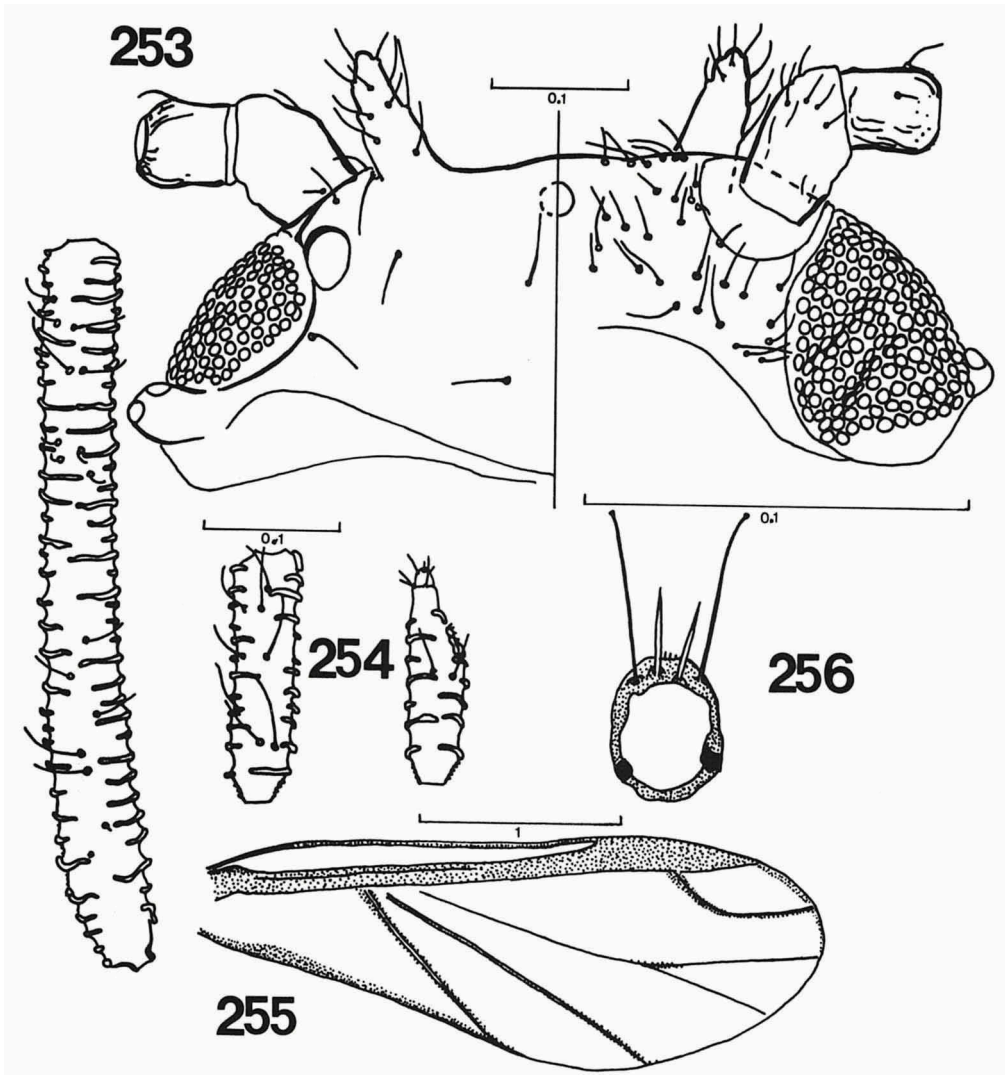

Fig. 252. *Ceratoplyphina bengalensis* L.K. Ghosh, apterous viviparous ♀, dorsal side of the body.



Figs. 253-256. *Ceratoglyphina bengalensis* L.K. Ghosh, alate viviparous ♀. Fig. 253, dorsal (left) and ventral (right) side of the head. Fig. 254, dorsal sides of antennal segments III-V. Fig. 255, fore wing. Fig. 256, first tarsal segment of the foreleg.



Fig. 257. *Ceratoglyphina bengalensis* L.K. Ghosh, alate viviparous ♀, dorsal sides of abdominal segments I-VIII.

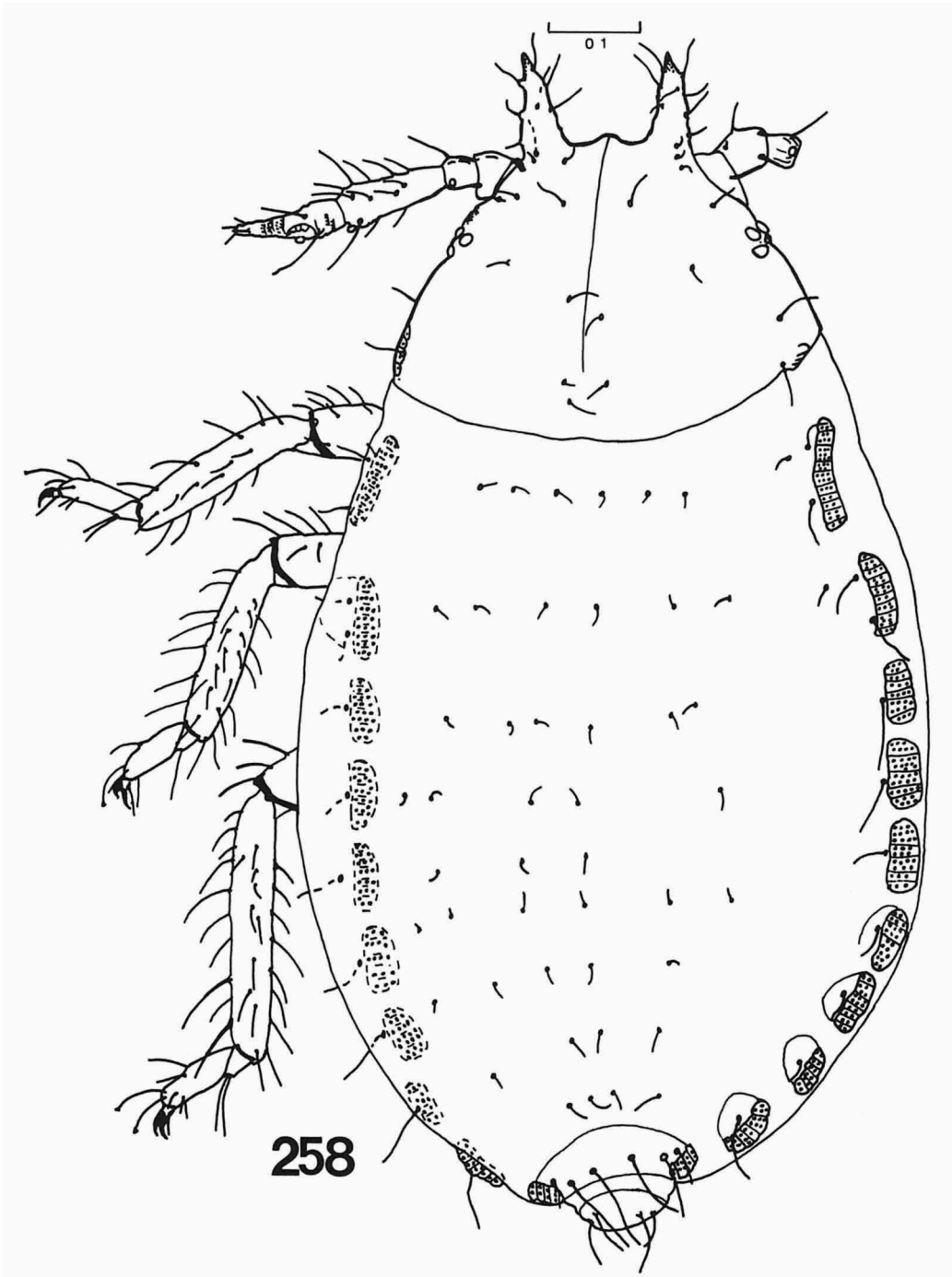

Fig. 258. *Ceratoglyphina bengalensis* L.K. Ghosh, first stage larva, normal, dorsal side.

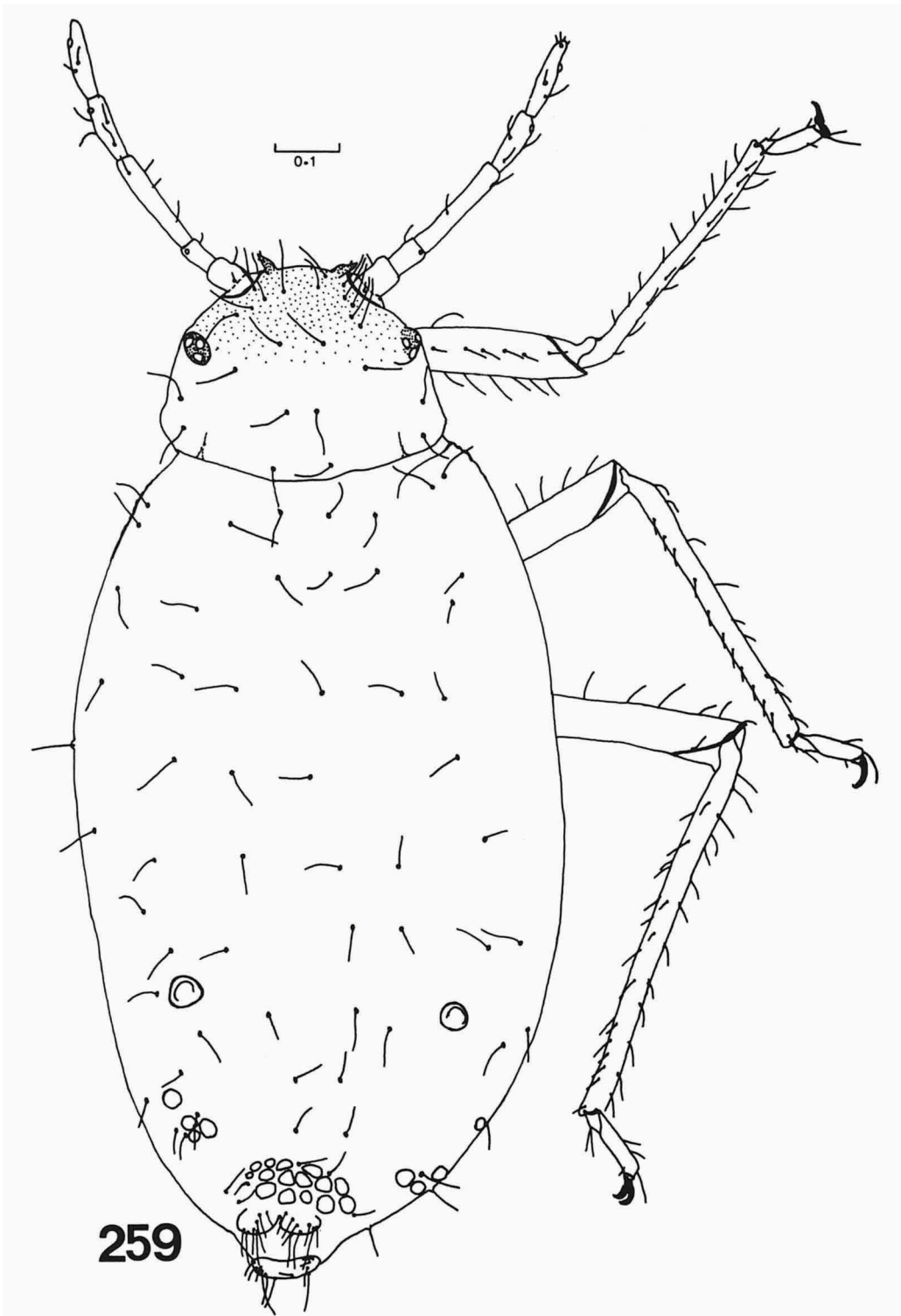
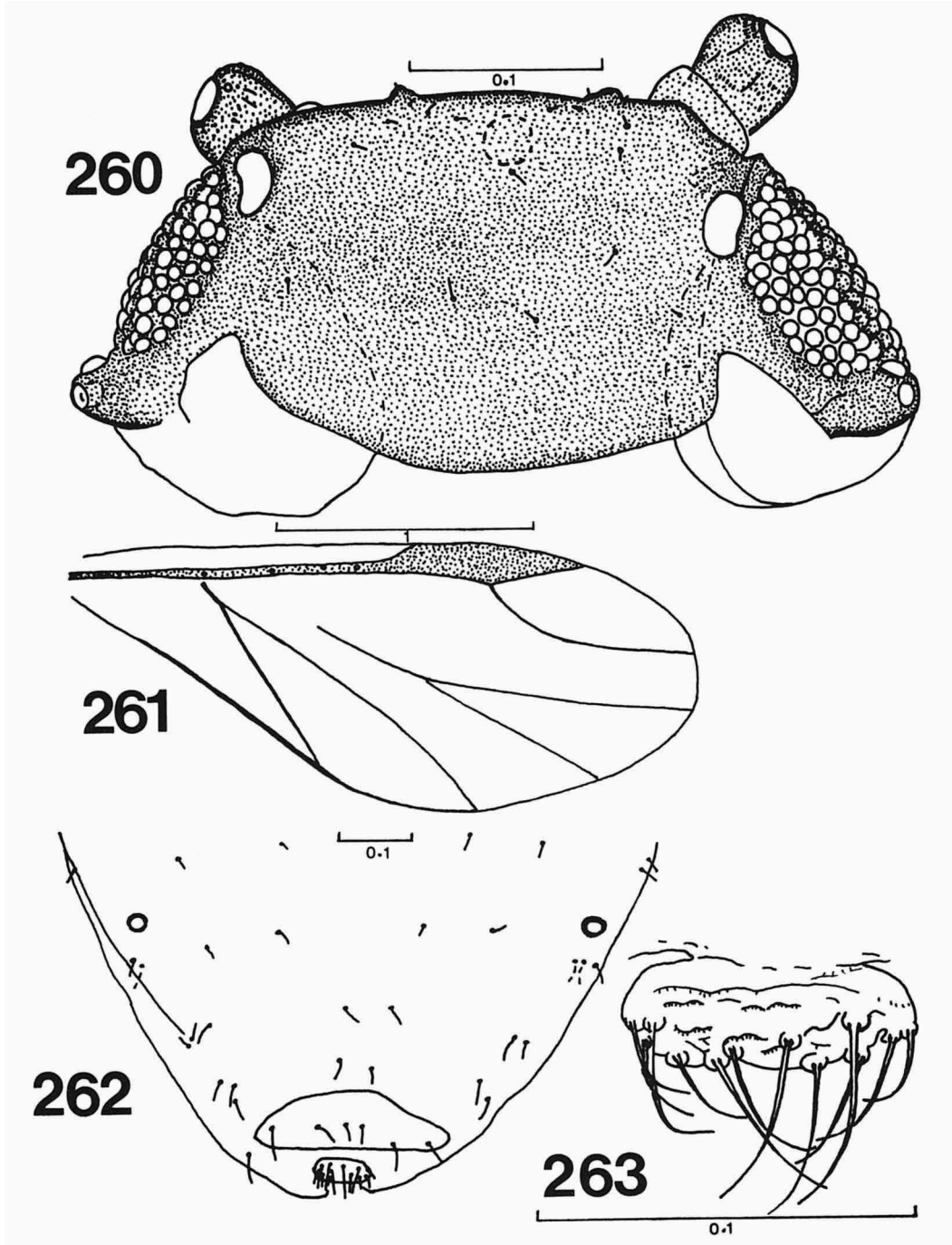

Fig. 259. *Ceratovacuna floccifera* spec. nov., apterous viviparous ♀, dorsal side.



Figs. 260-263. *Ceratovacuna floccifera* spec. nov., alate viviparous ♀. Fig. 260, dorsal side of the head. Fig. 261, fore wing. Fig. 262, dorsal sides of abdominal segments IV-VIII. Fig. 263, cauda.

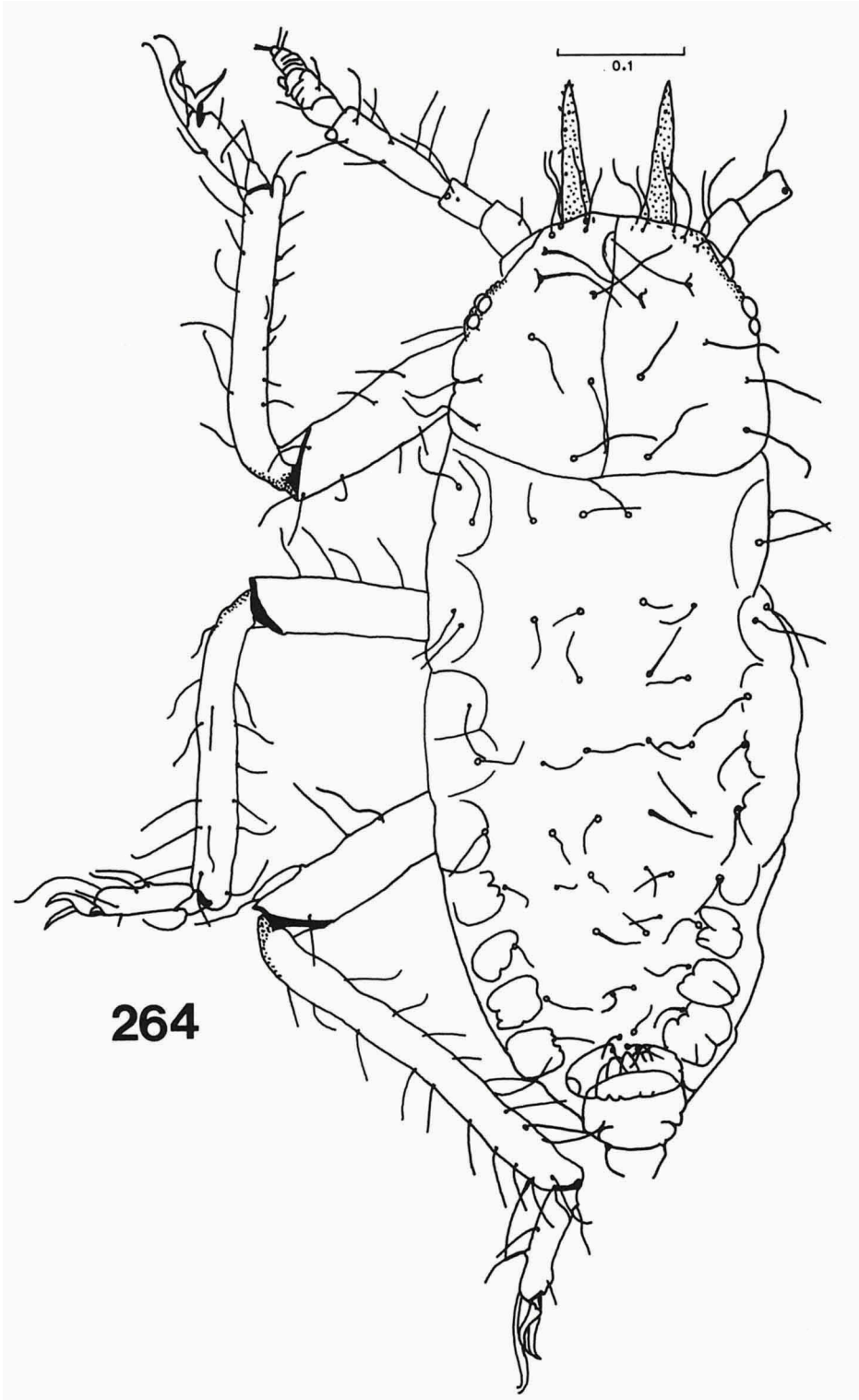

Fig. 264. *Ceratovacuna floccifera* spec. nov., first stage larva, normal, dorsal side.

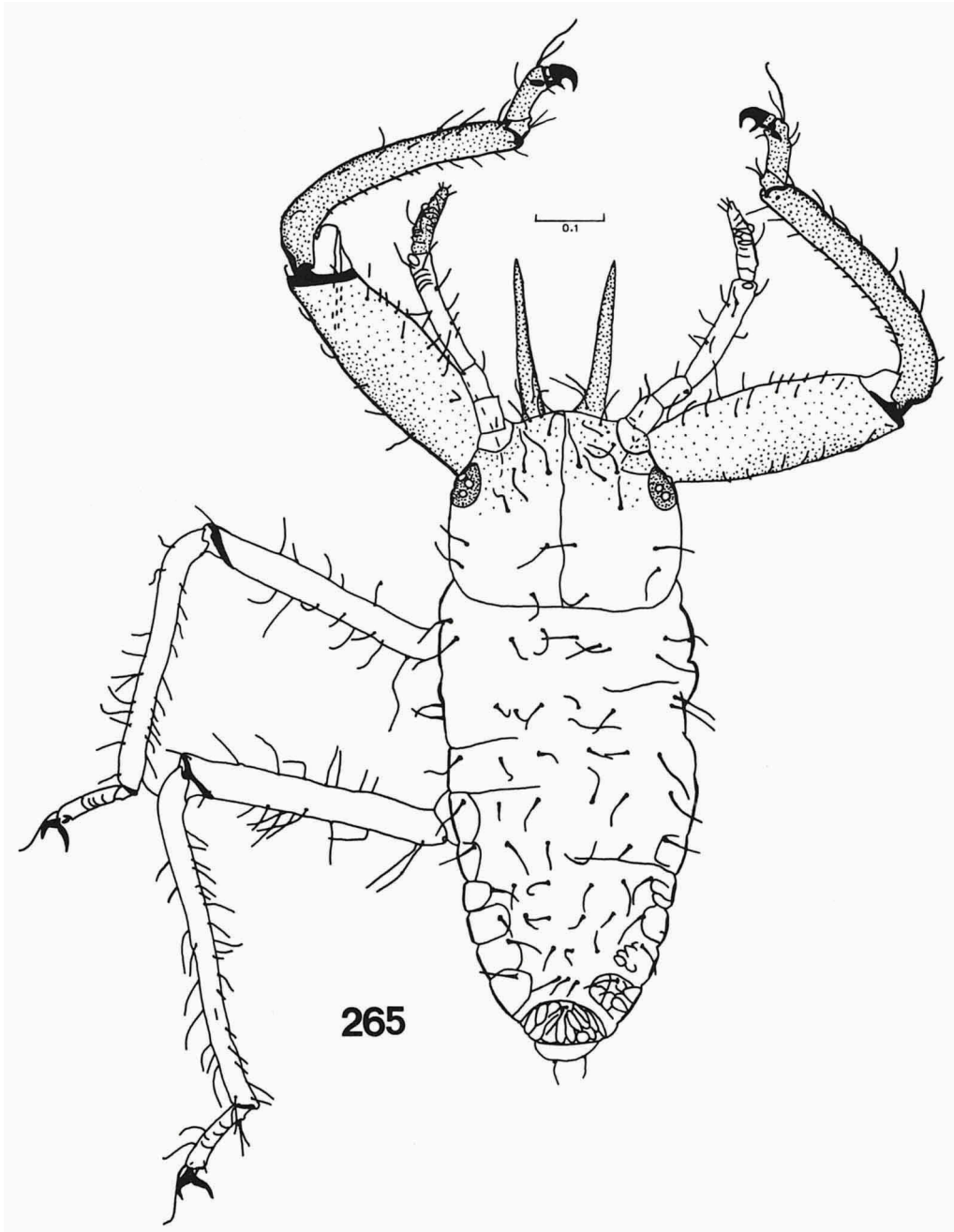
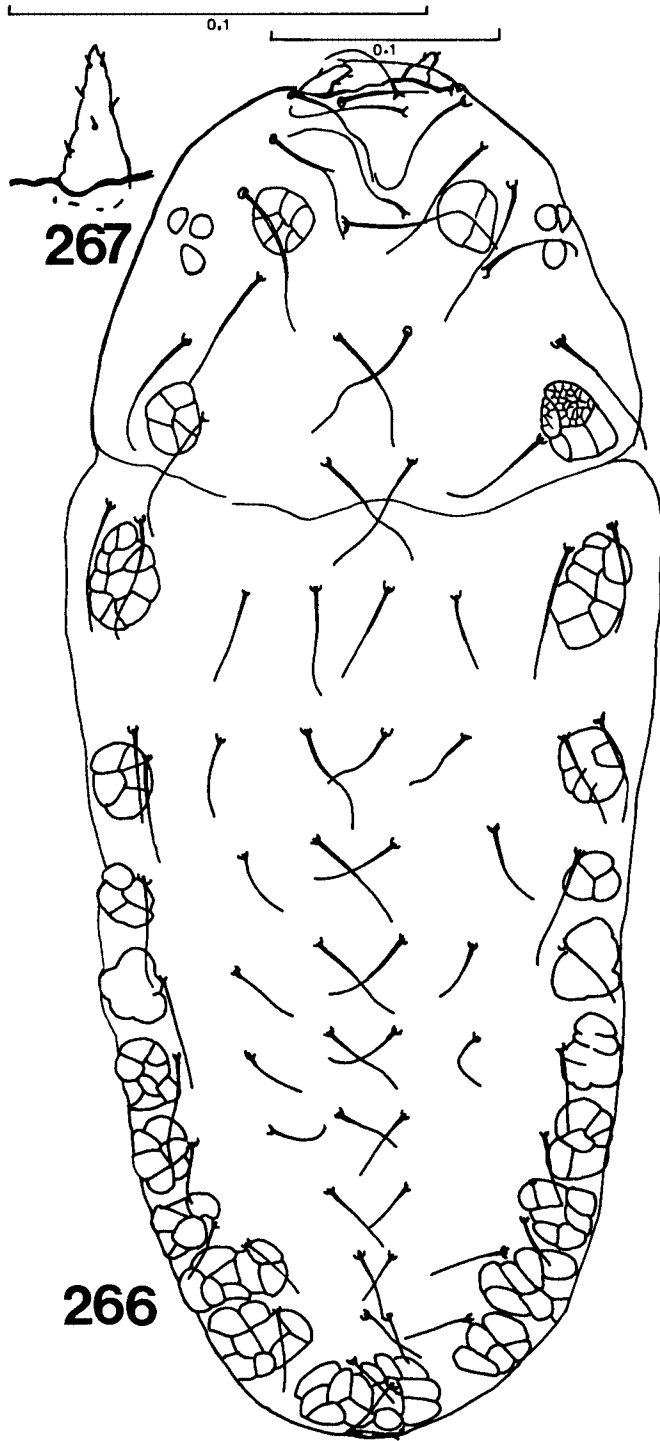

Fig. 265. *Ceratovacuna floccifera* spec. nov., first stage larva, soldier, dorsal side.





Figs. 266-267. *Ceratovacuna floccifera* spec. nov., embryo inside alate viviparous ♀. Fig. 266, dorsal side of the body. Fig. 267, horn.



Fig. 268. *Ceratovacuna graminum* (Van der Goot), apterous viviparous ♀, dorsal side of the body. Specimen from Vietnam.

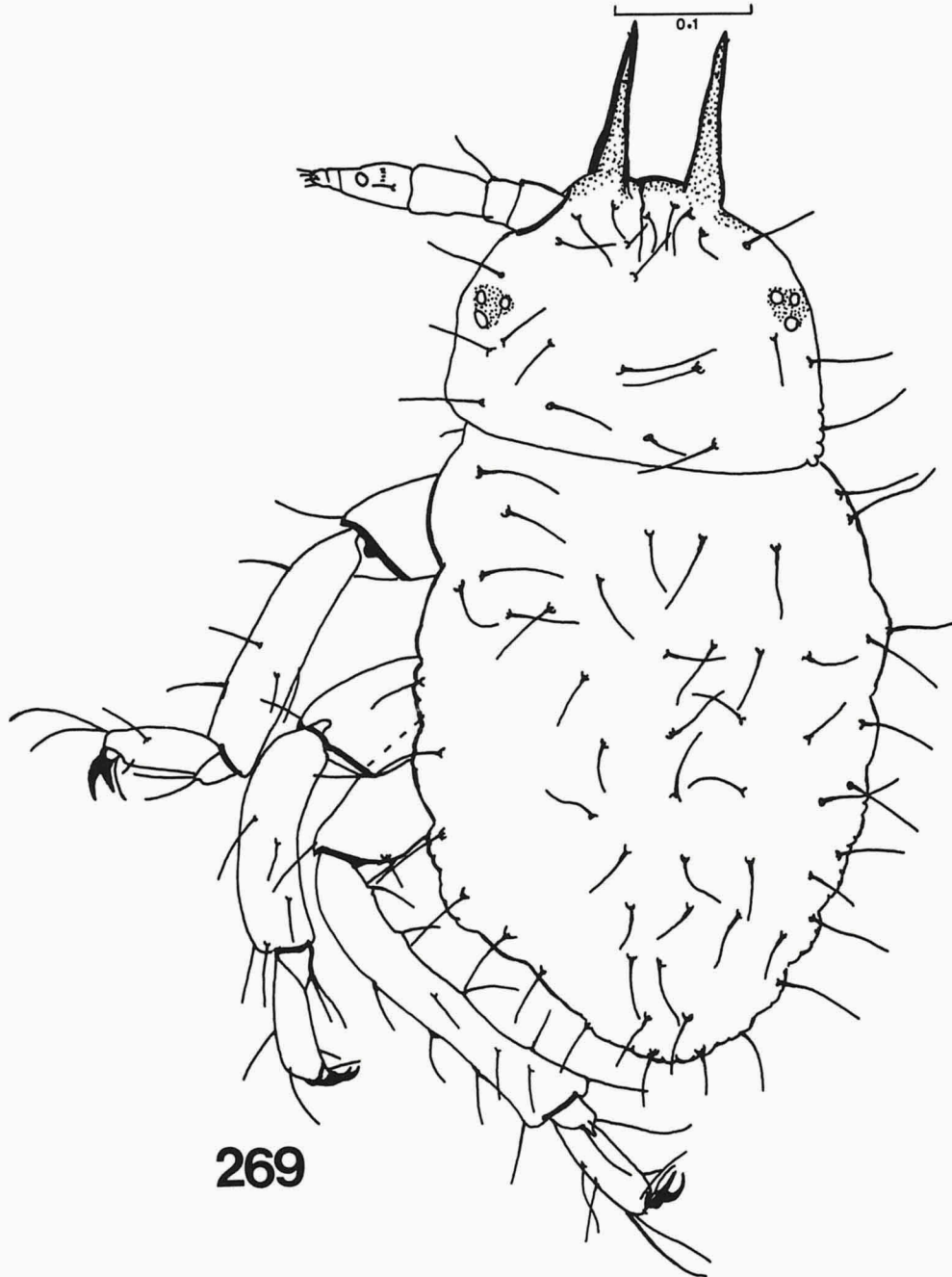

Fig. 269. *Ceratovacuna graminum* (Van der Goot), first stage larva of apterous viviparous ♀, dorsal side. Specimen from Vietnam, leg R. Bielowski, 2.vi.1966.

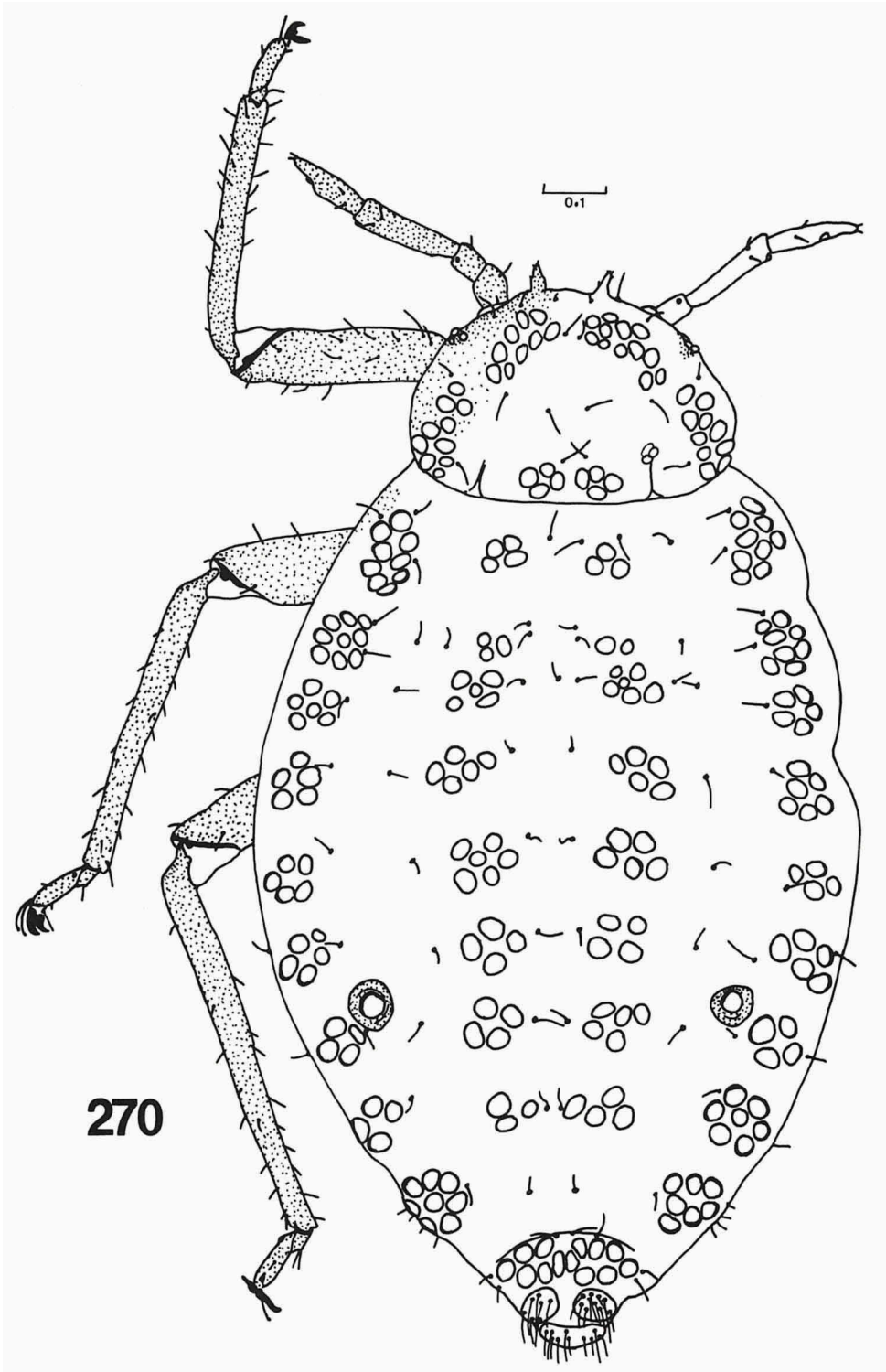

Fig. 270. *Ceratovacuna keduensis* spec. nov., apterous viviparous ♀, dorsal side of the body.

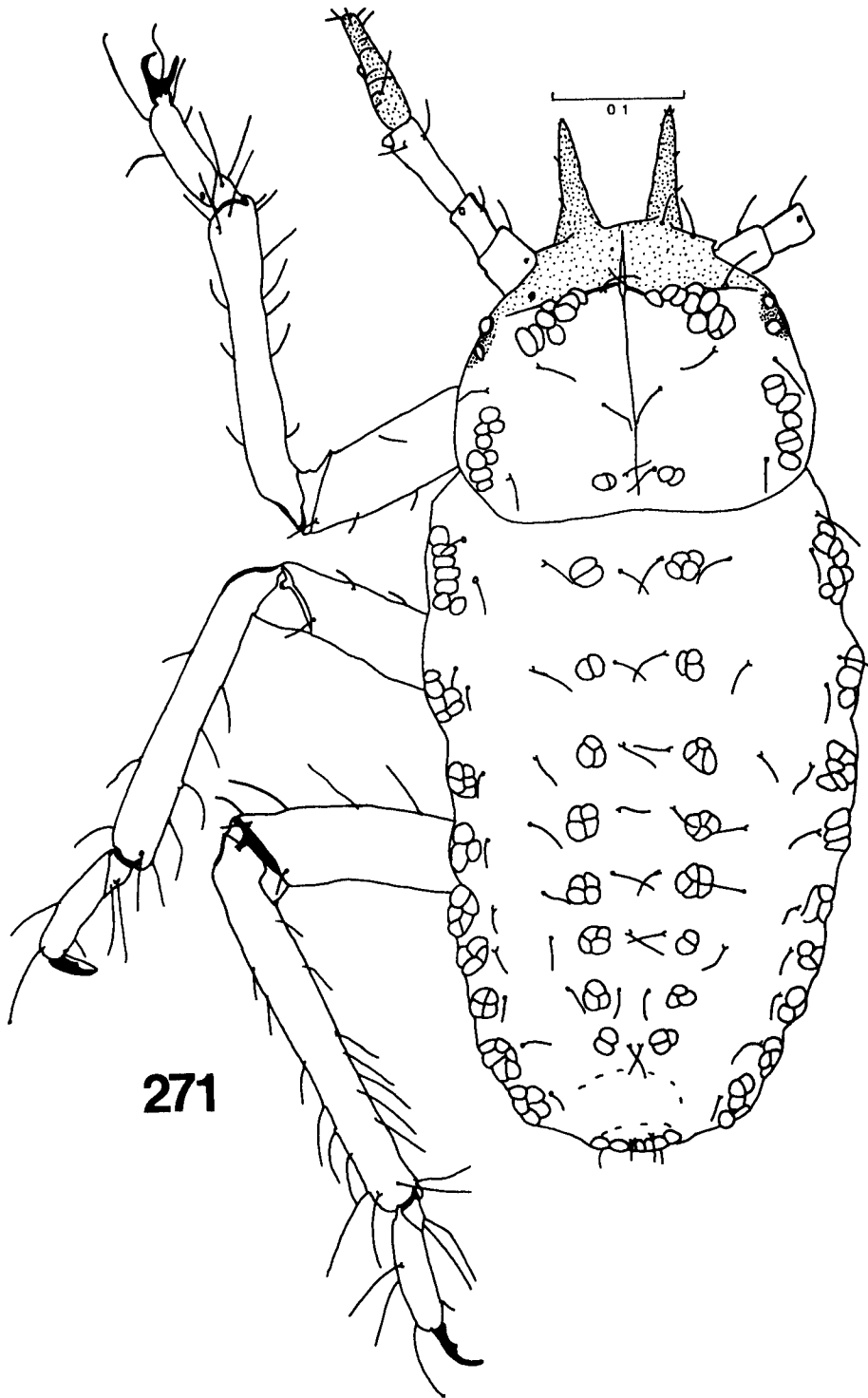

Fig. 271. *Ceratovacuna keduensis* spec. nov., first stage larva, normal, dorsal side.

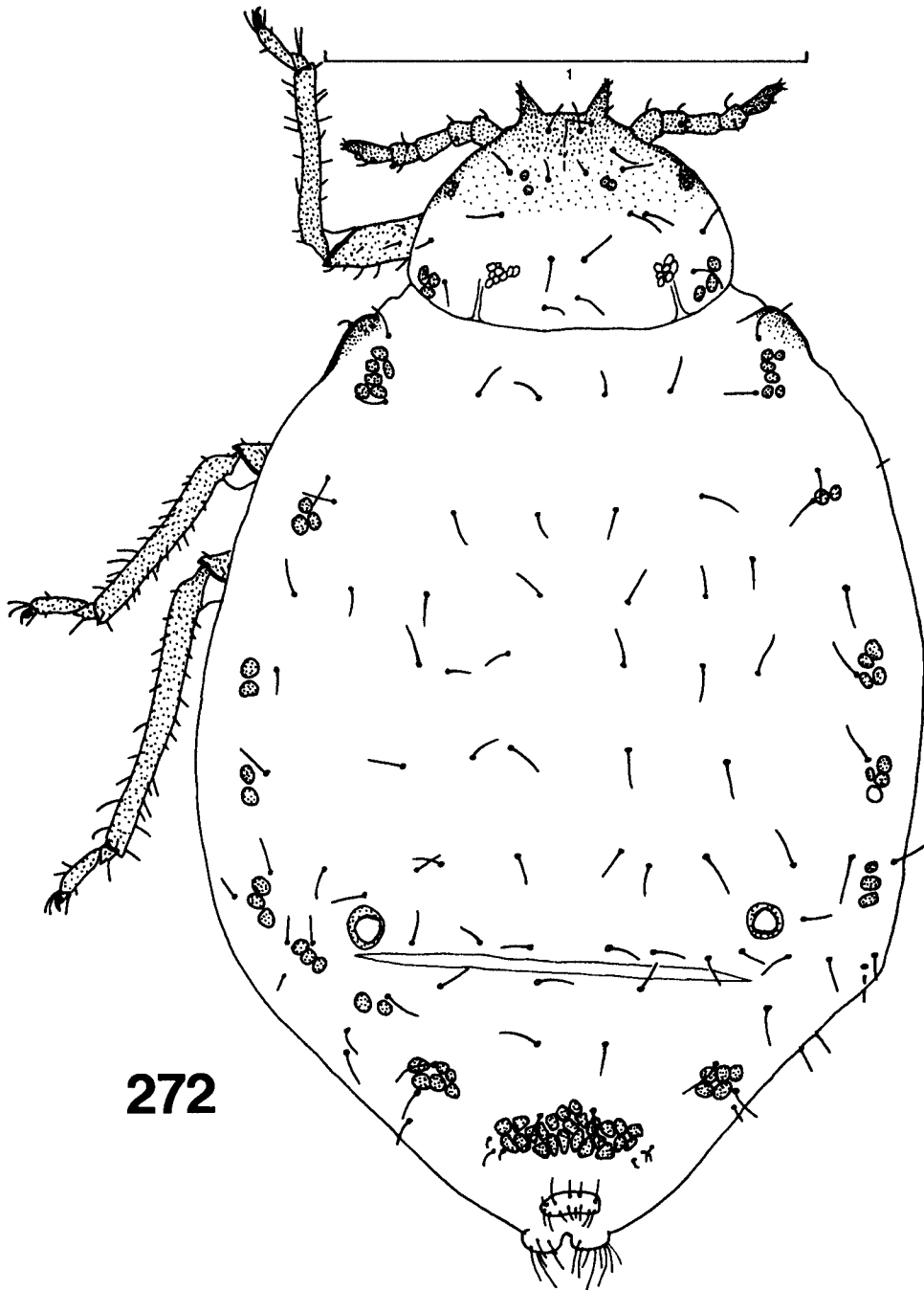
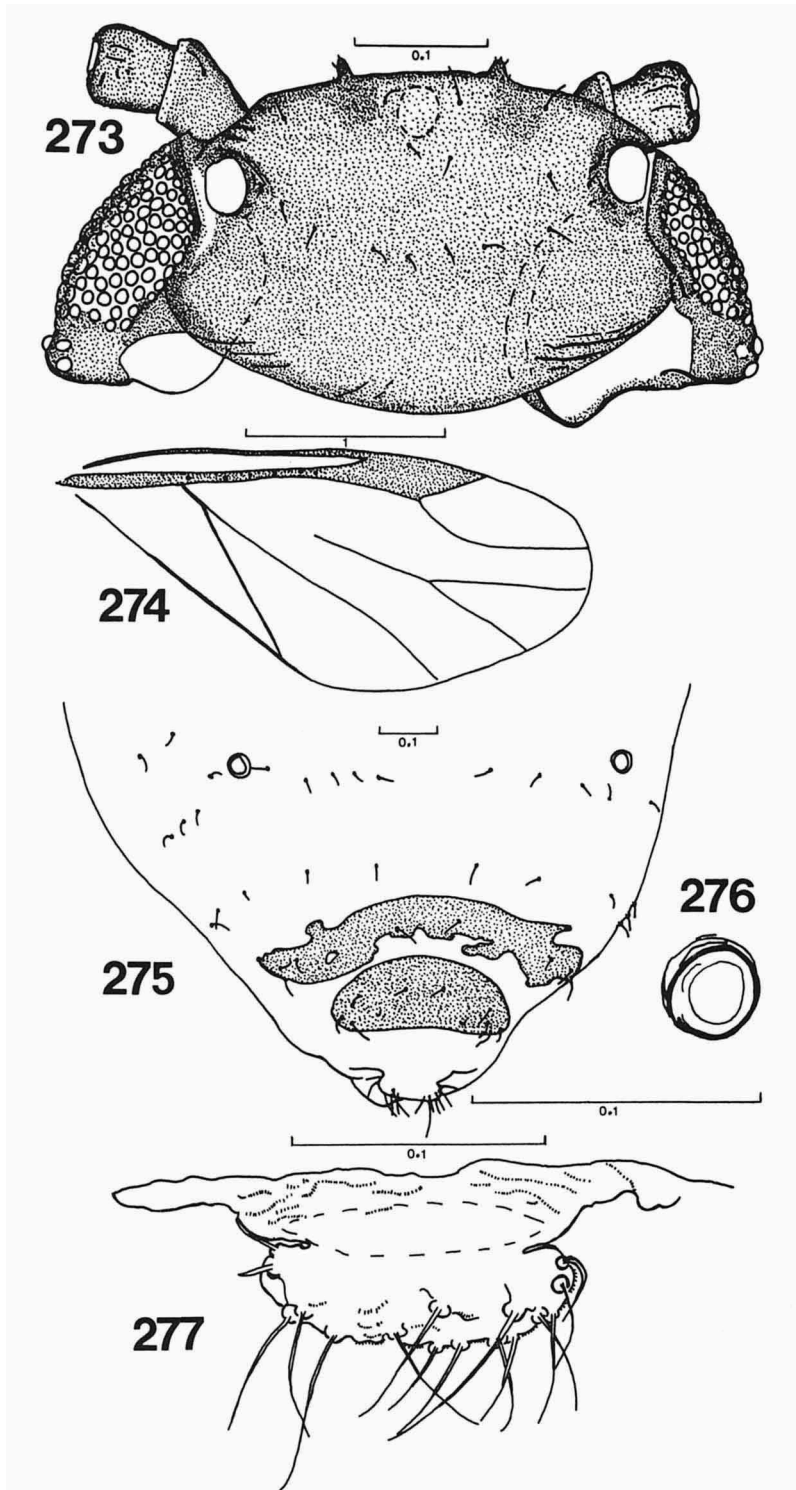

Fig. 272. *Ceratovacuna lanigera* Zehntner, apterous viviparous ♀, dorsal side.



Figs. 273-277. *Ceratovacuna lanigera* Zehntner, alate viviparous ♀. Fig. 273, dorsal side of the head. Fig. 274, fore wing. Fig. 275, dorsal sides of abdominal segments V-VIII. Fig. 276, siphunculus. Fig. 277, cauda.

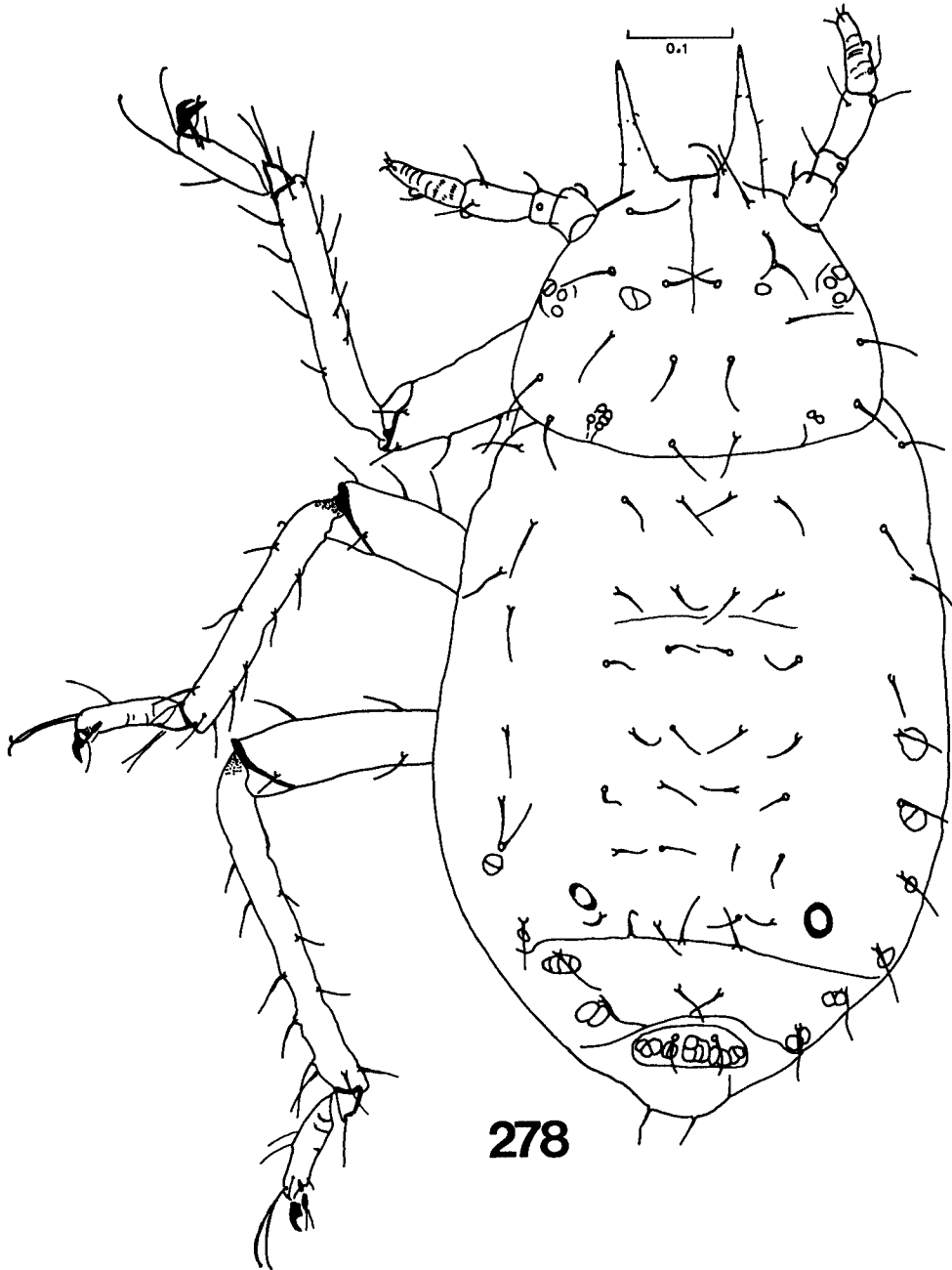

Fig. 278. *Ceratovacuna lanigera* Zehntner, first stage larva of apterous viviparous ♀, dorsal side of the body.



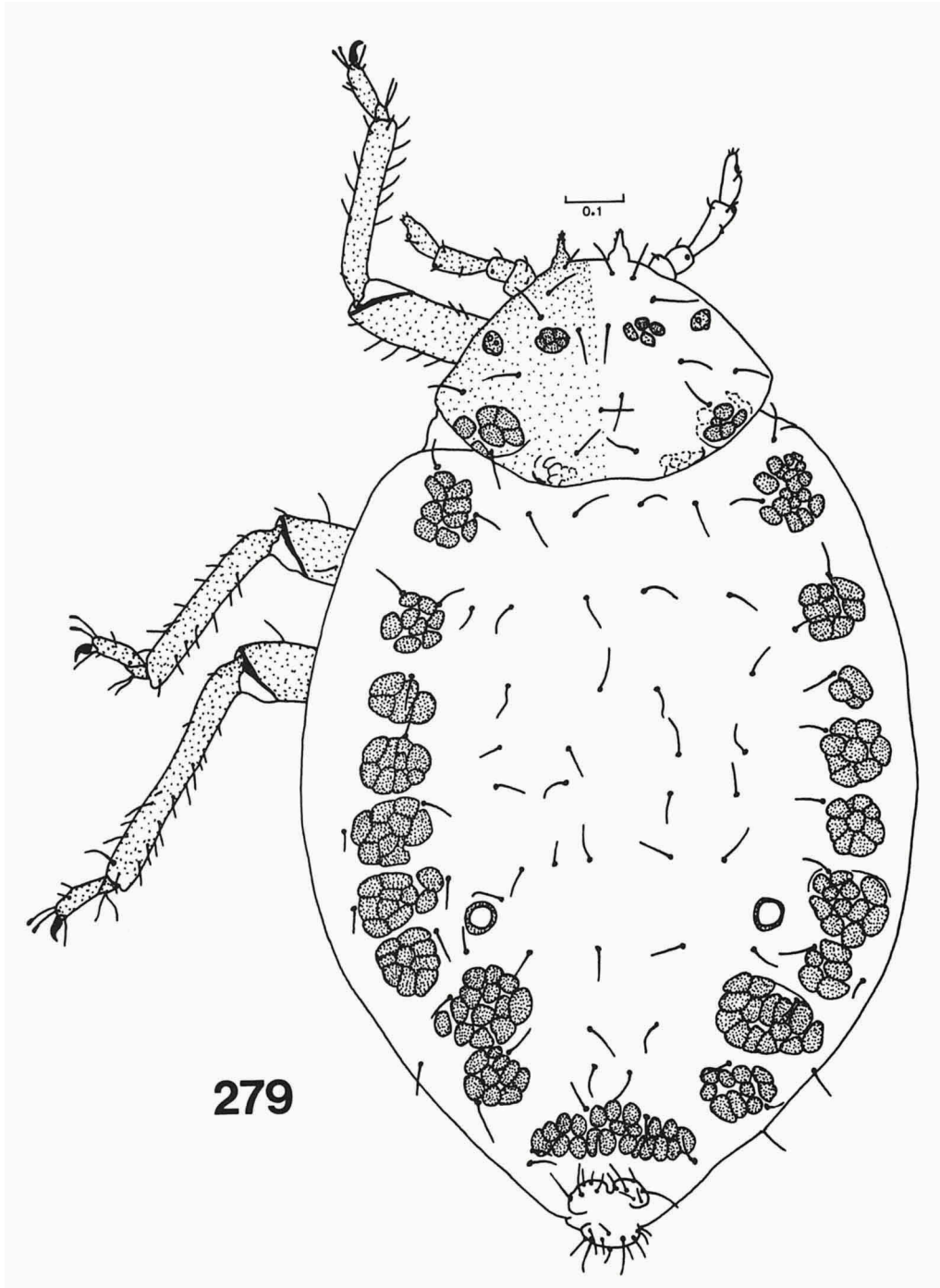
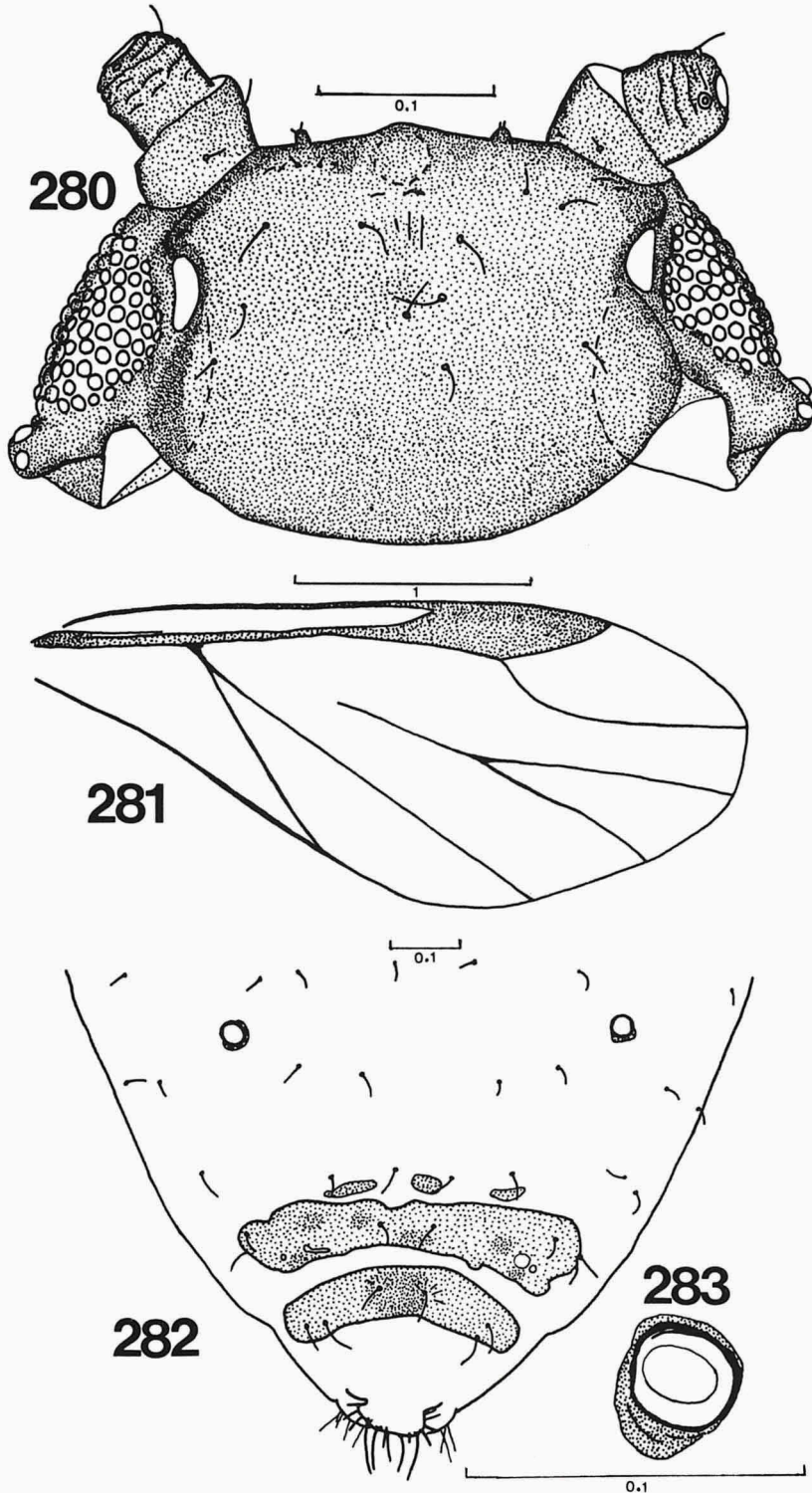

Fig. 279. *Ceratovacuna panici* (Van der Goot), apterous viviparous ♀, dorsal side of the body.



Figs. 280-283. *Ceratovacuna panici* (Van der Goot), alate viviparous ♀. Fig. 280, dorsal side of the head. Fig. 281, fore wing. Fig. 282, dorsal sides of abdominal segments IV-VIII. Fig. 283, siphunculus.

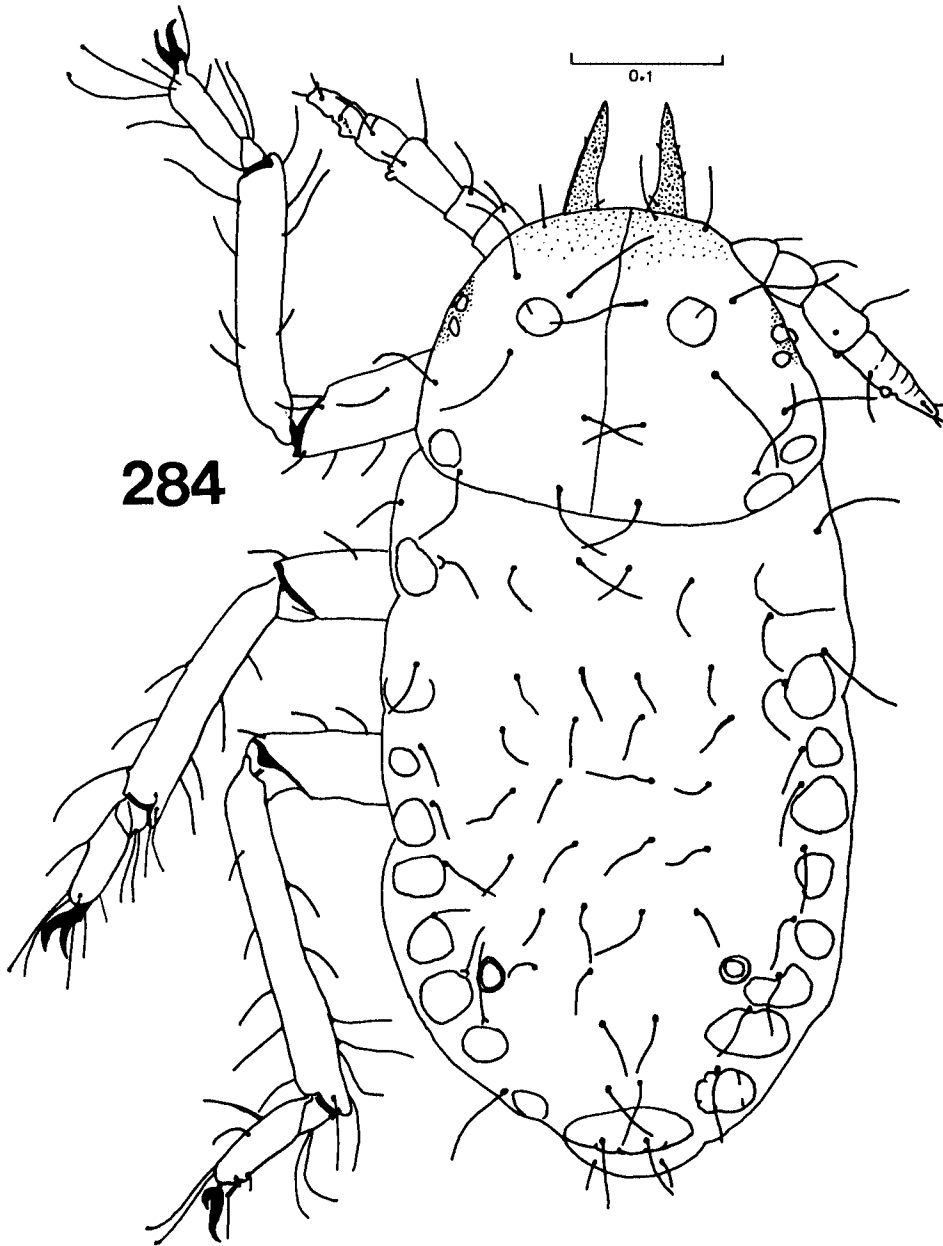
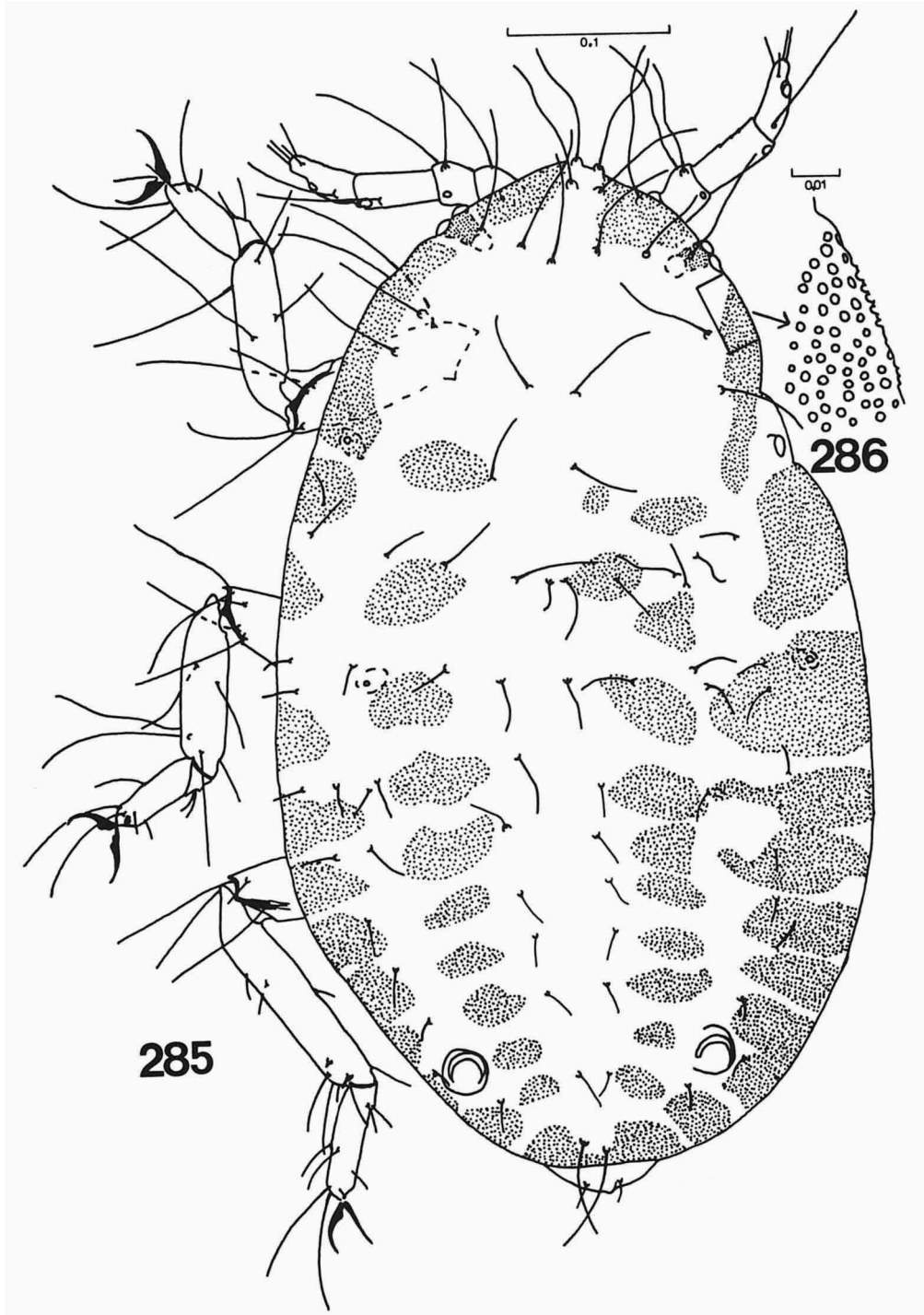
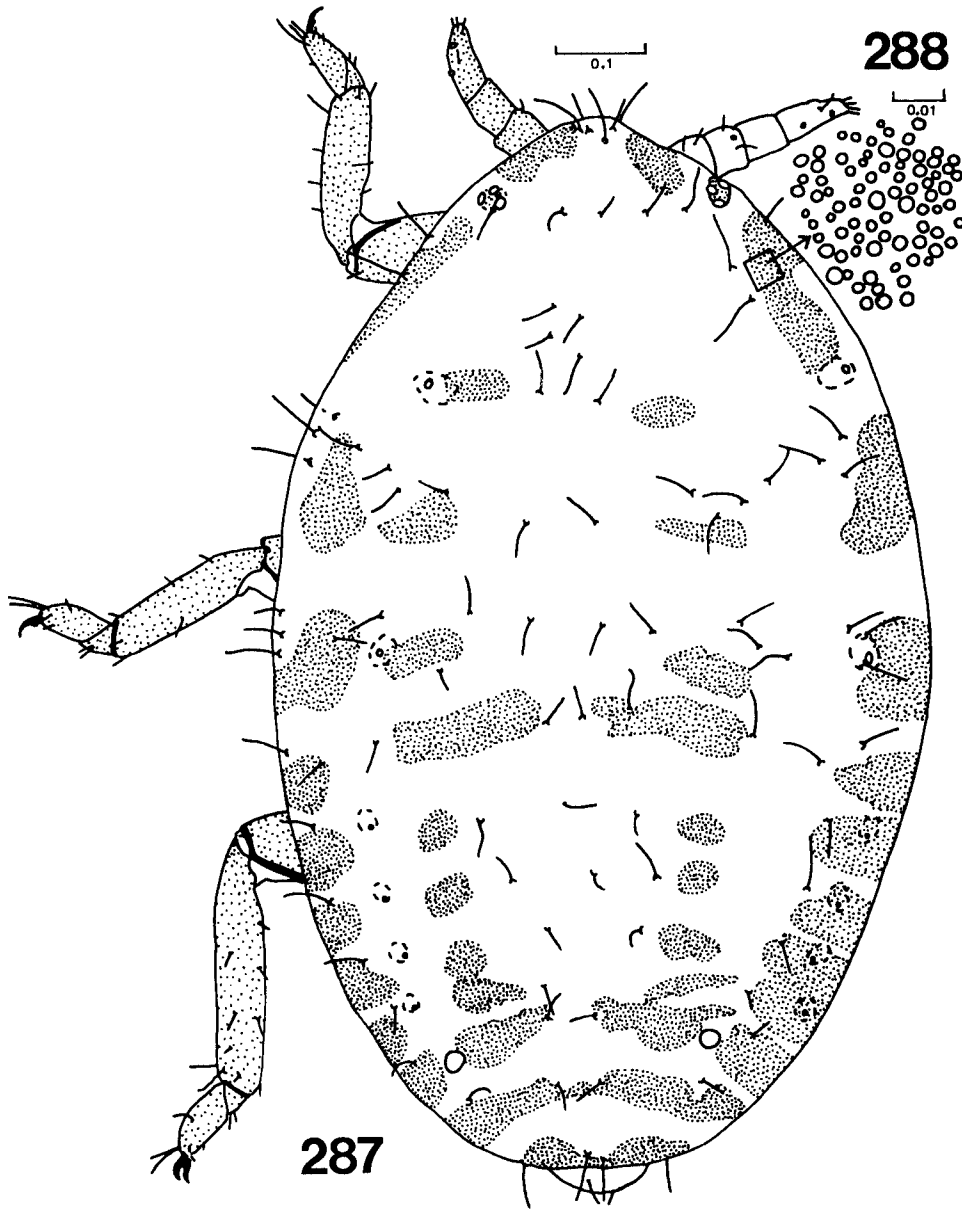

Fig. 284. *Ceratovacuna panici* (Van der Goot), first stage larva, normal.



Figs. 285-286. *Distylaphis foliorum* (Van der Goot), first stage larva from leaf of *Distylium stellare*. Fig. 285, dorsal side of the body. Fig. 286, wax glands.



Figs. 287-288. *Distylaphis foliorum* (Van der Goot), last stage larva of apterous viviparous ♀ from leaf of *Distylium stellare*. Fig. 287, dorsal side of the body. Fig. 288, wax glands.

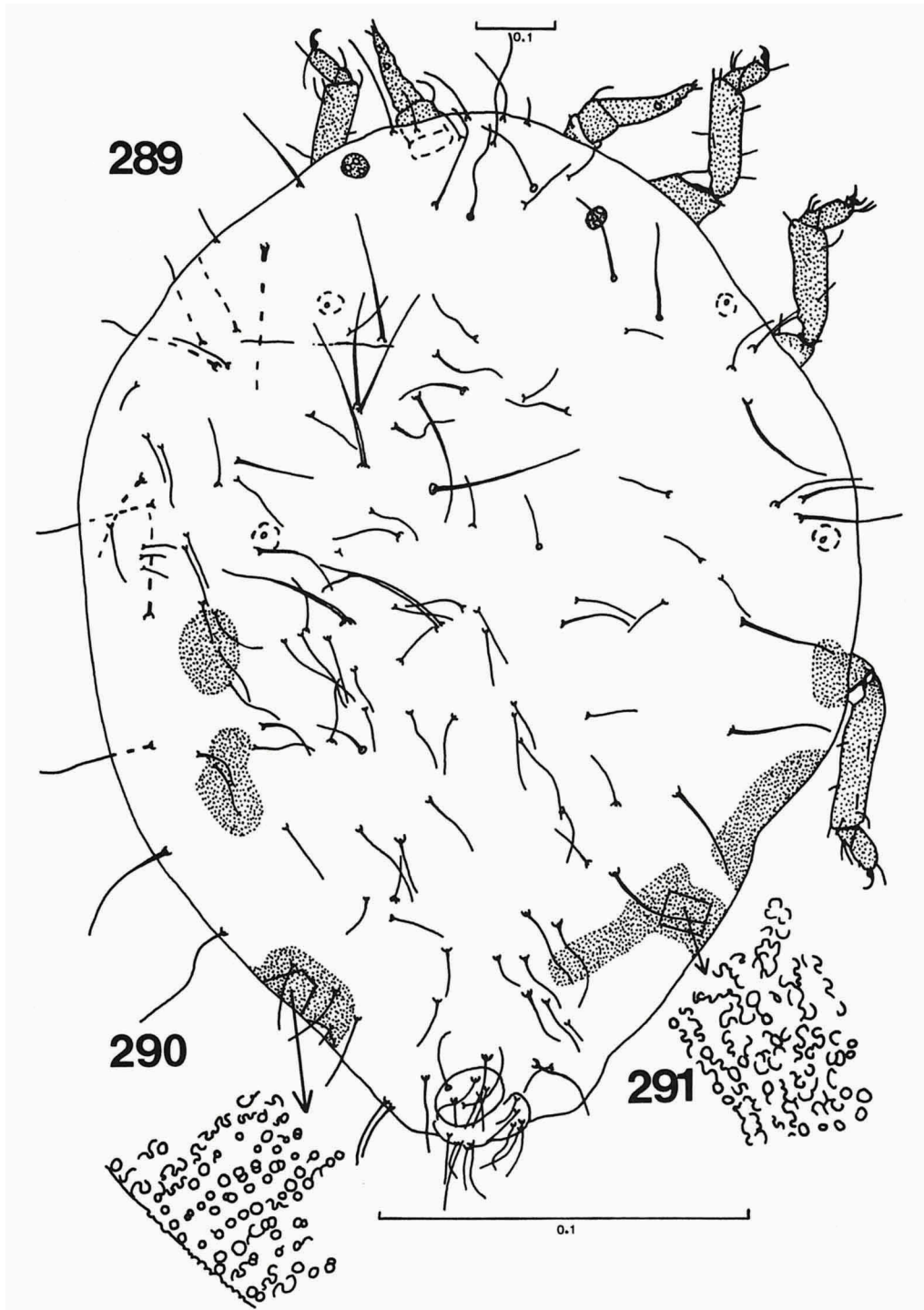

Figs. 289-291. *Distylaphis foliorum* (Van der Goot), apterous viviparous ♀ from gall No. 3 from *Distylium stellare*. Fig. 289, dorsal side of the body. Figs. 290-291, wax glands ventrally and dorsally on the margin of the abdomen.

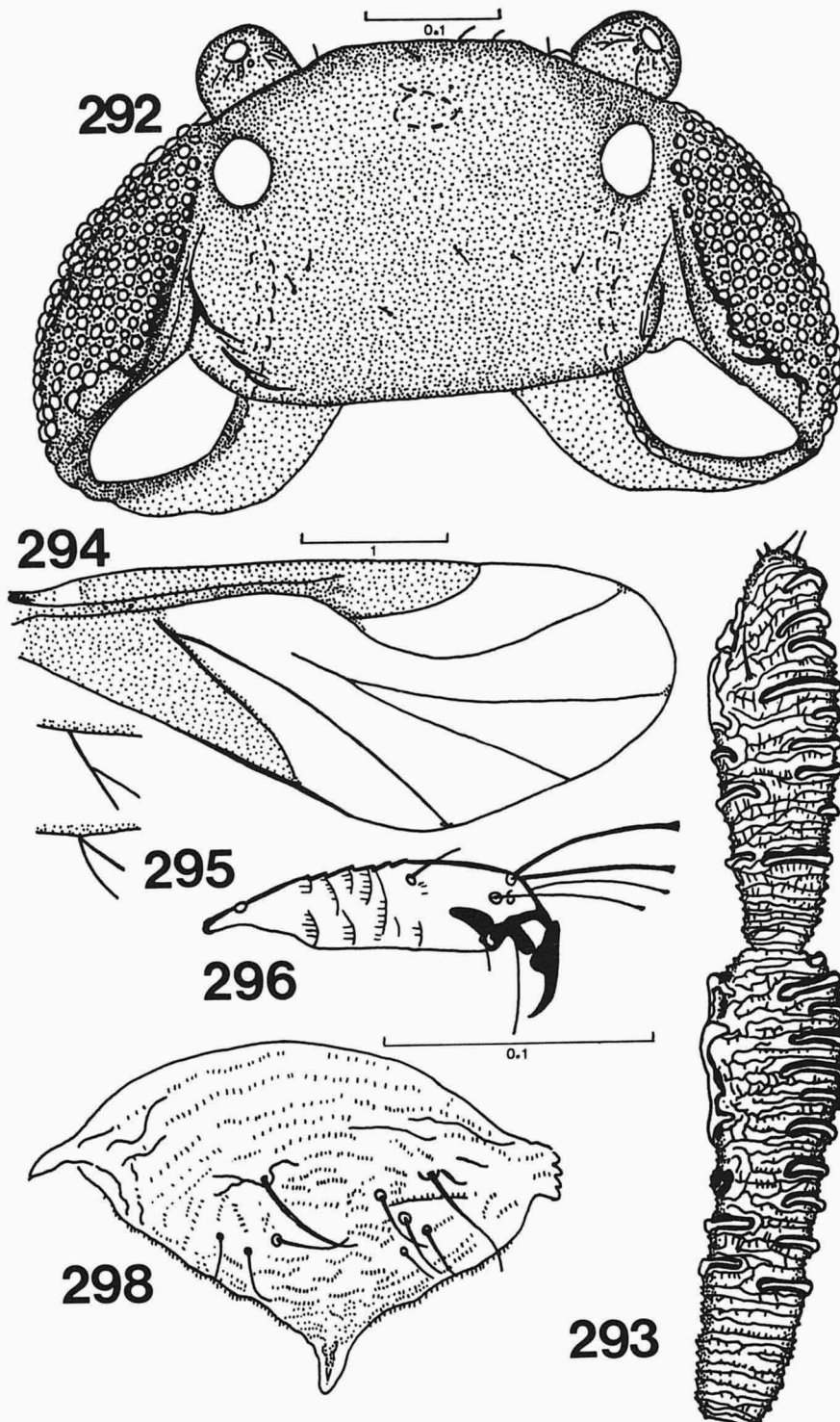

Figs. 292-296, 298. *Distylaphis foliorum* (Van der Goot), alate viviparous ♀ from gall. No. 3 from *Distylium stellare*. Fig. 292, dorsal side of the head. Fig. 293, dorsal sides of antennal segments IV-V. Fig. 294, fore wing. Fig. 295, the base of anal vein and cubitus of two wings. Fig. 296, second tarsal segment of the hind leg. Fig. 298, cauda.

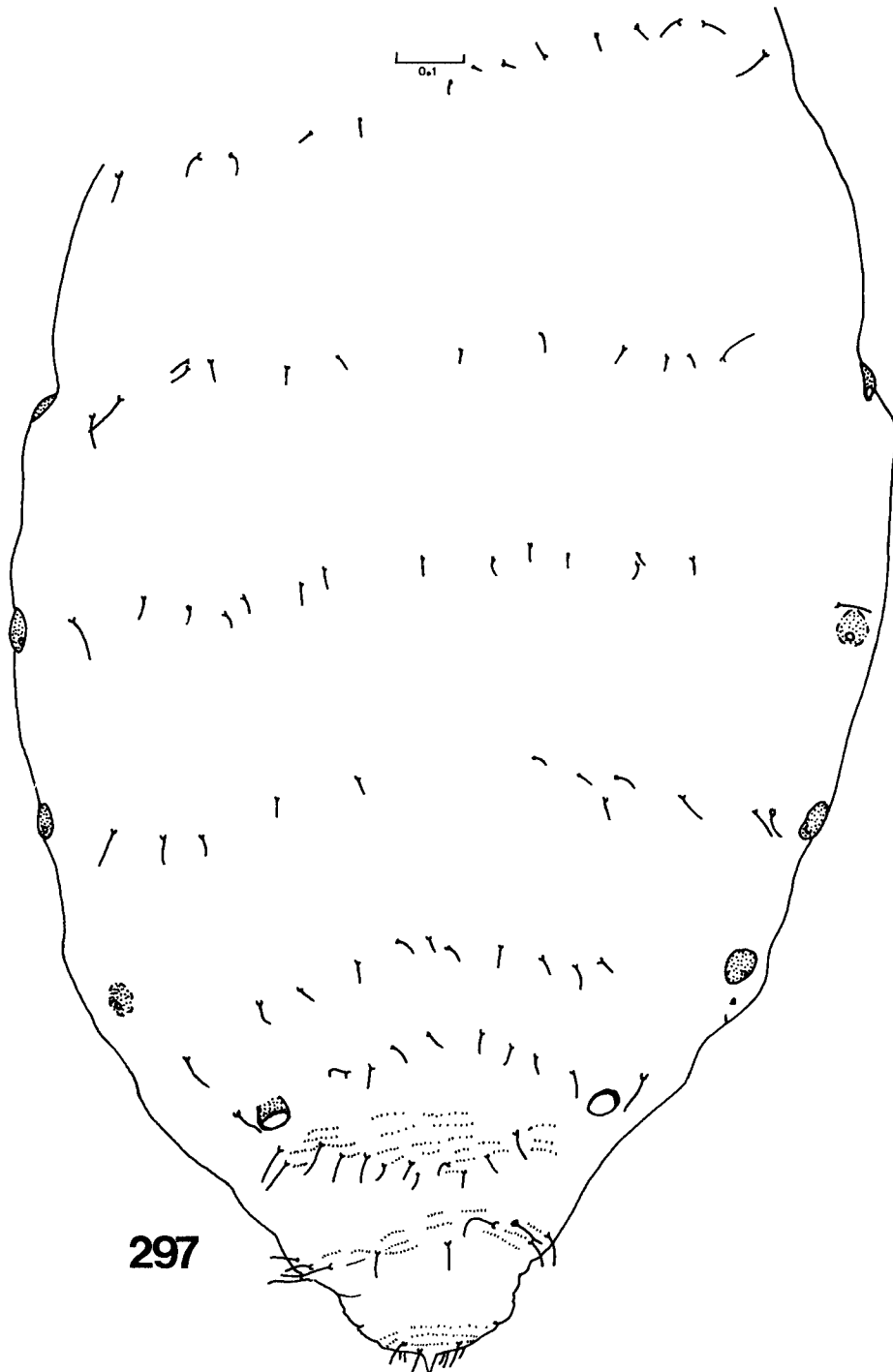

Fig. 297. *Distylaphis foliorum* (Van der Goot), alate viviparous ♀ from gall No. 3 from *Distylium stellare*, dorsal sides of abdominal segments I-VIII.



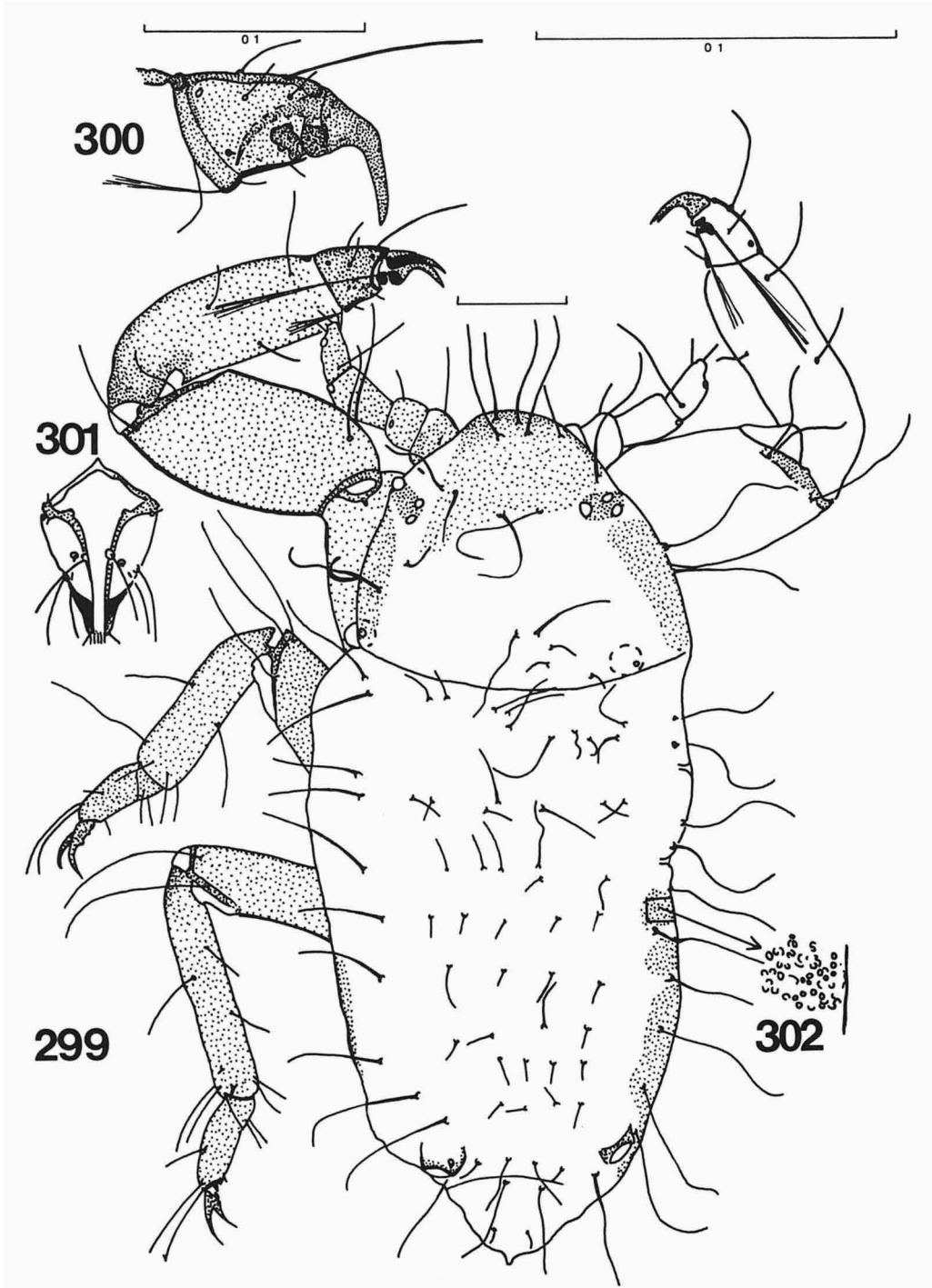
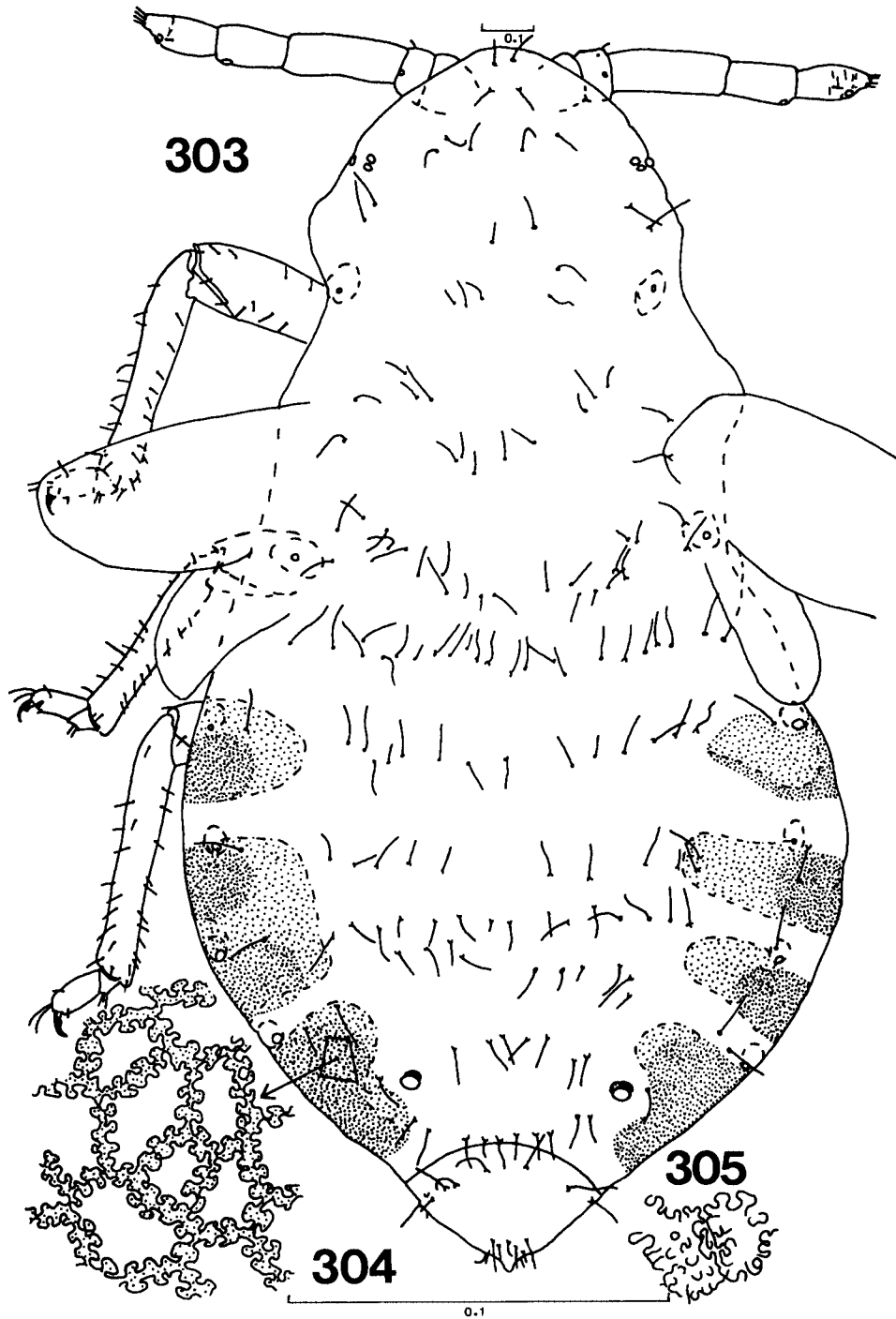
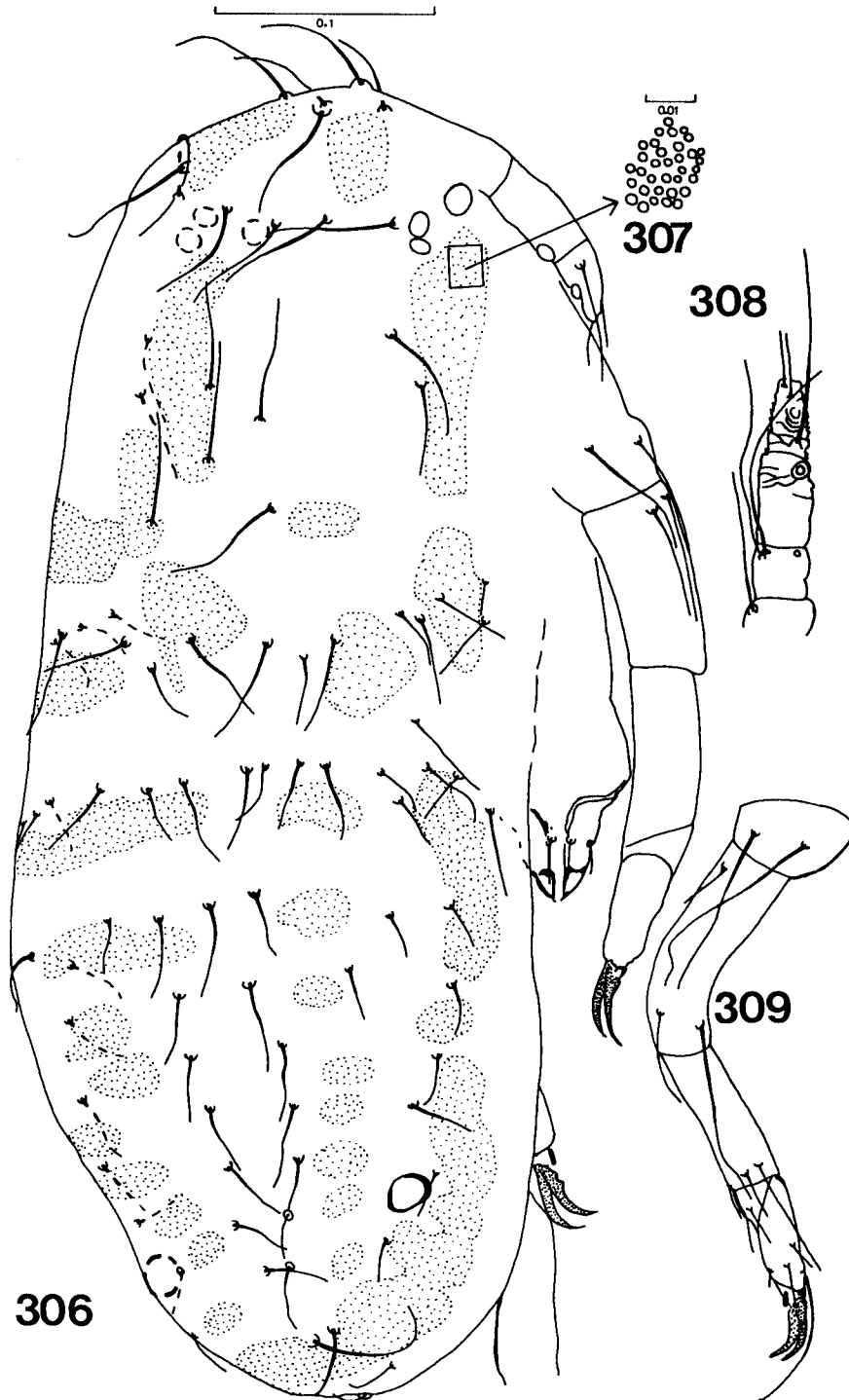

Fig. 299-302. *Distylaphis foliorum* (Van der Goot), first stage larva, soldier, from gall No. 3 from *Distylium stellare*. Fig. 299, dorsal side of the body. Fig. 300, first and second tarsal segments of the foreleg. Fig. 301, ultimate rostral segment. Fig. 302, wax glands at the margin of the abdomen.



Figs. 303-305. *Distylaphis foliorum* (Van der Goot), last stage larva of alate viviparous ♀ from gall No. 3 from *Distylium stellare*. Fig. 303, dorsal side of the body, pointed areas indicate wax glands. Fig. 304, wax glands. Fig. 305, wax glands occurring rarely in some areas.



Figs. 306-309. *Distylaphis foliorum* (Van der Goot), embryo inside alate viviparous ♀ from gall No. 3 from *Distylium stellare*. Fig. 306, dorsal side of the body, dotted areas indicate wax glands. Fig. 307, wax glands. Fig. 308, antenna. Fig. 309, foreleg.

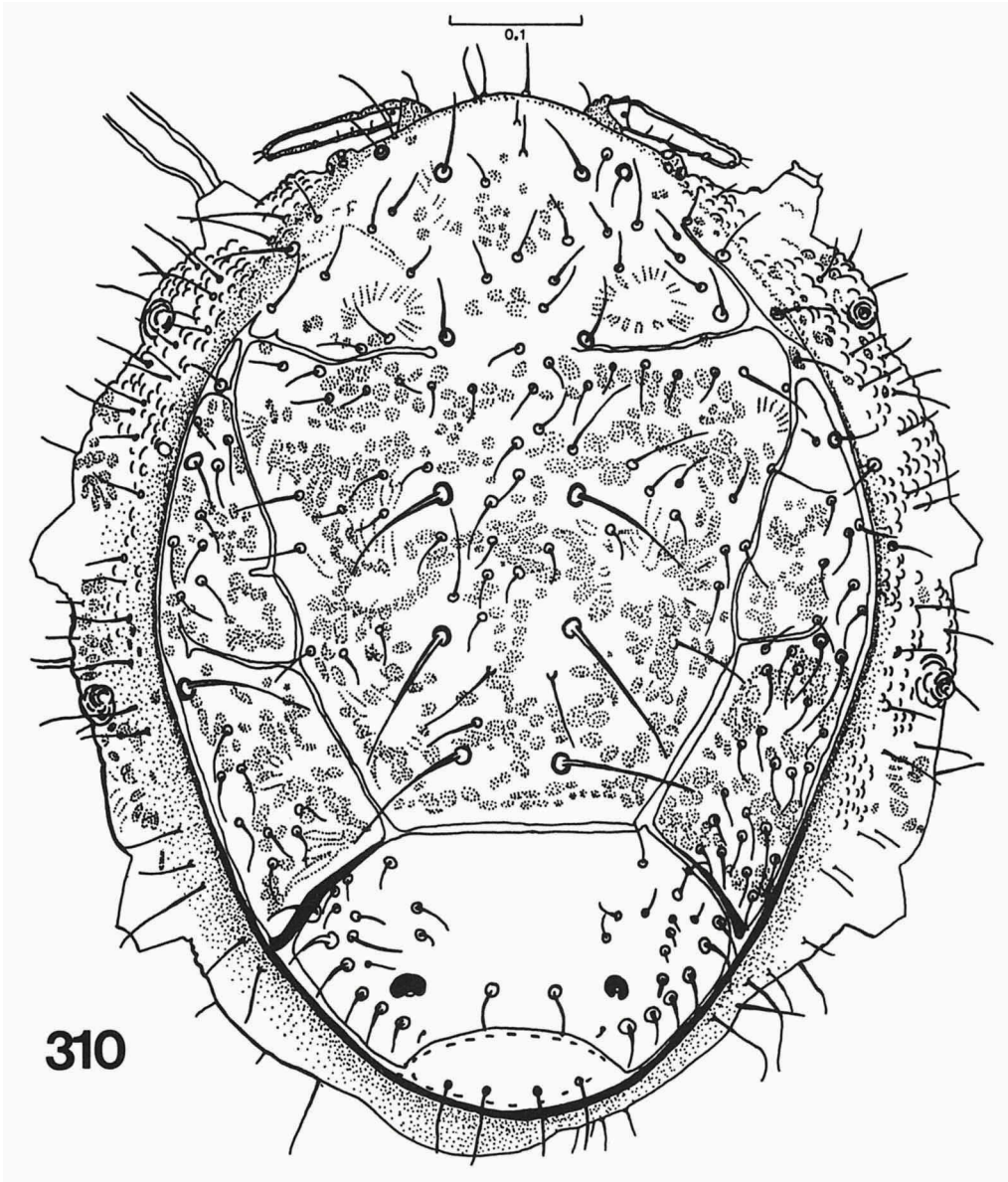

Fig. 310. *Euthoracaphis heterotricha* Ghosh and Raychaudhuri, apterous viviparous ♀, dorsal side of the body.

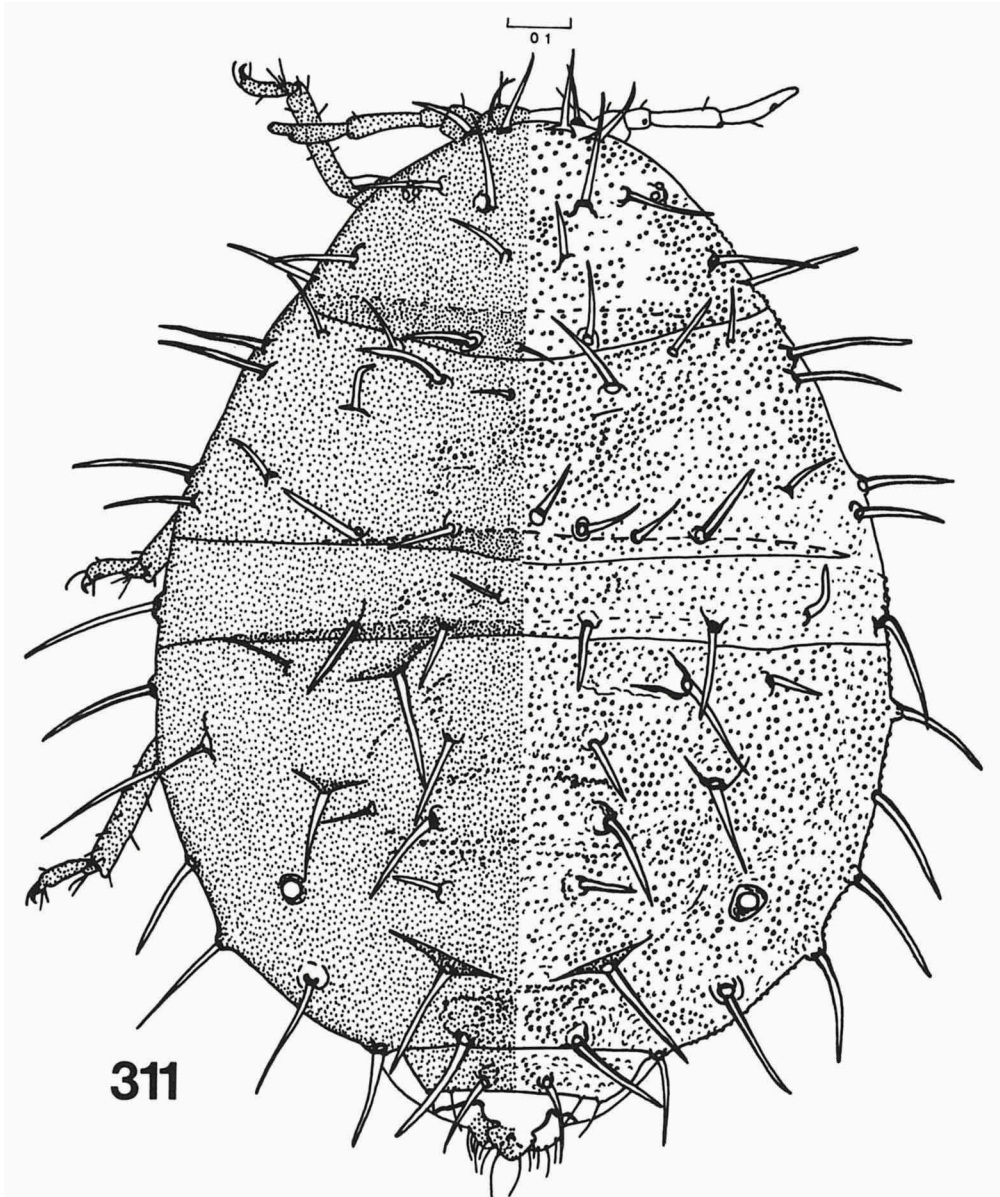
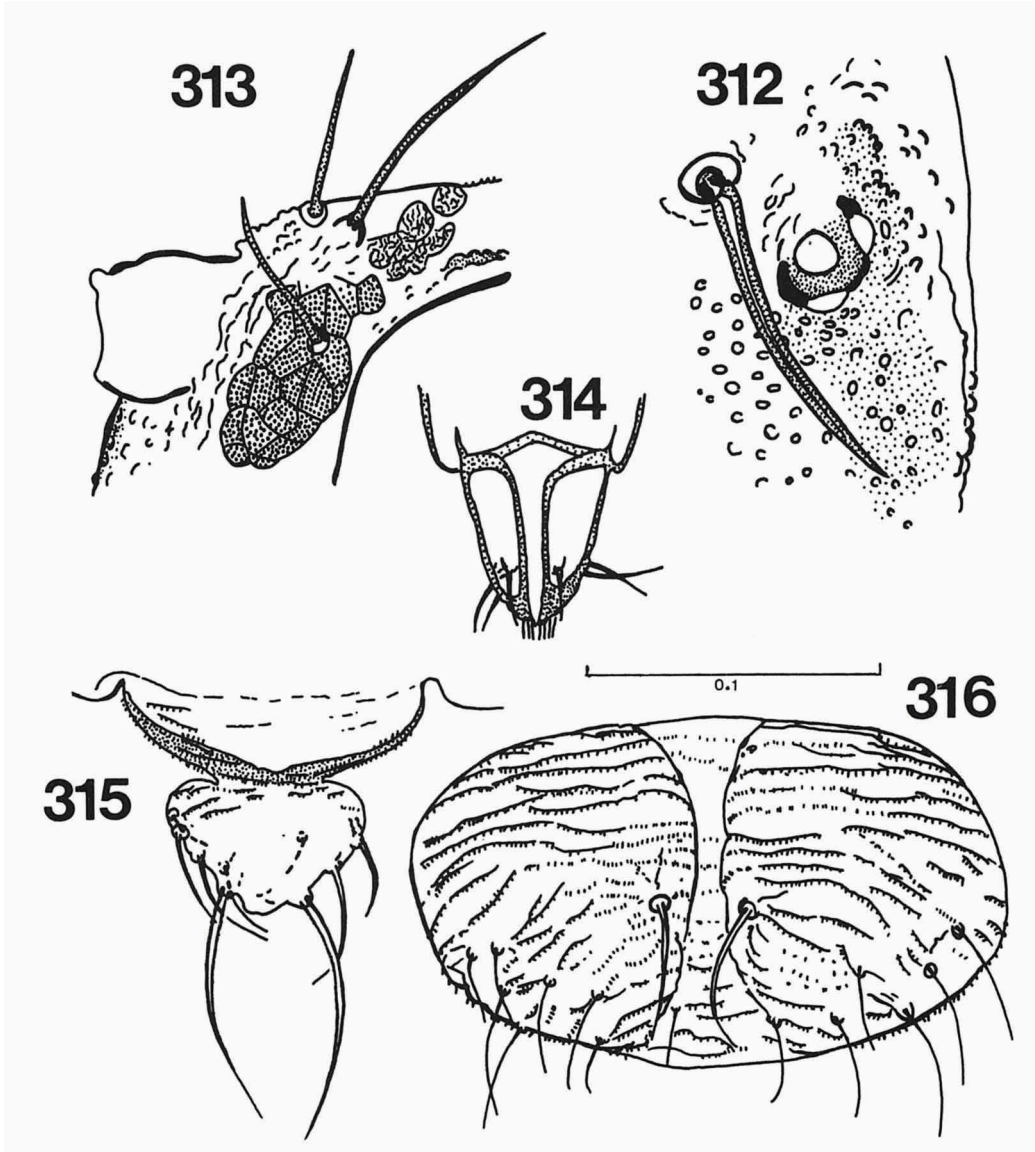

Fig. 311. *Glyphinaphis bambusae* Van der Goot, apterous viviparous ♀, dorsal side of the body.



Figs. 312-316. *Glyphinaphis bambusae* Van der Goot, apterous viviparous ♀. Fig. 312, area of the eye, dorsal side. Fig. 313, wax glands ventrally close to the base of the antenna; the two anterior hairs are located dorsally. Fig. 314, ultimate rostral segment. Fig. 315, cauda. Fig. 316, subgenital plate.

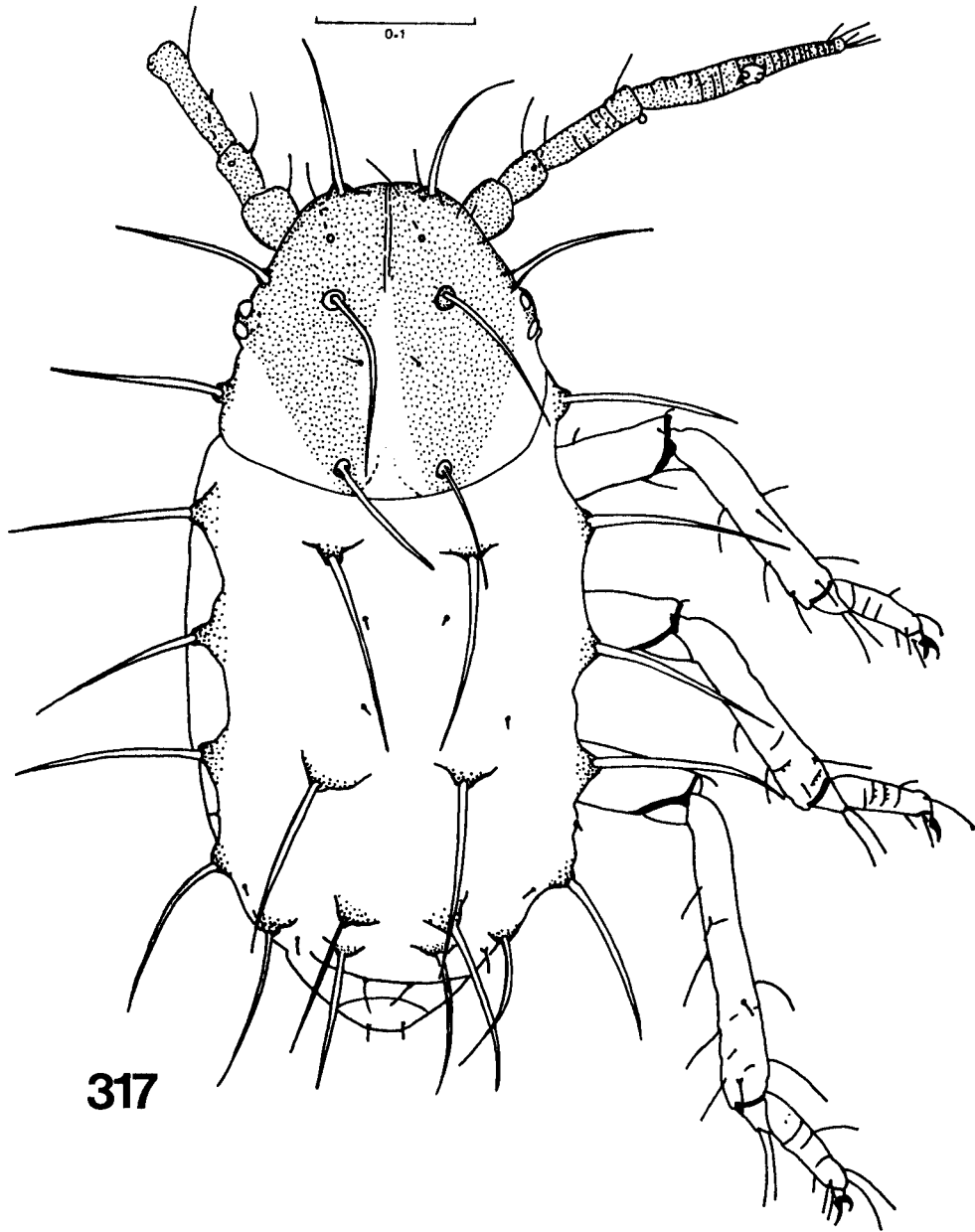
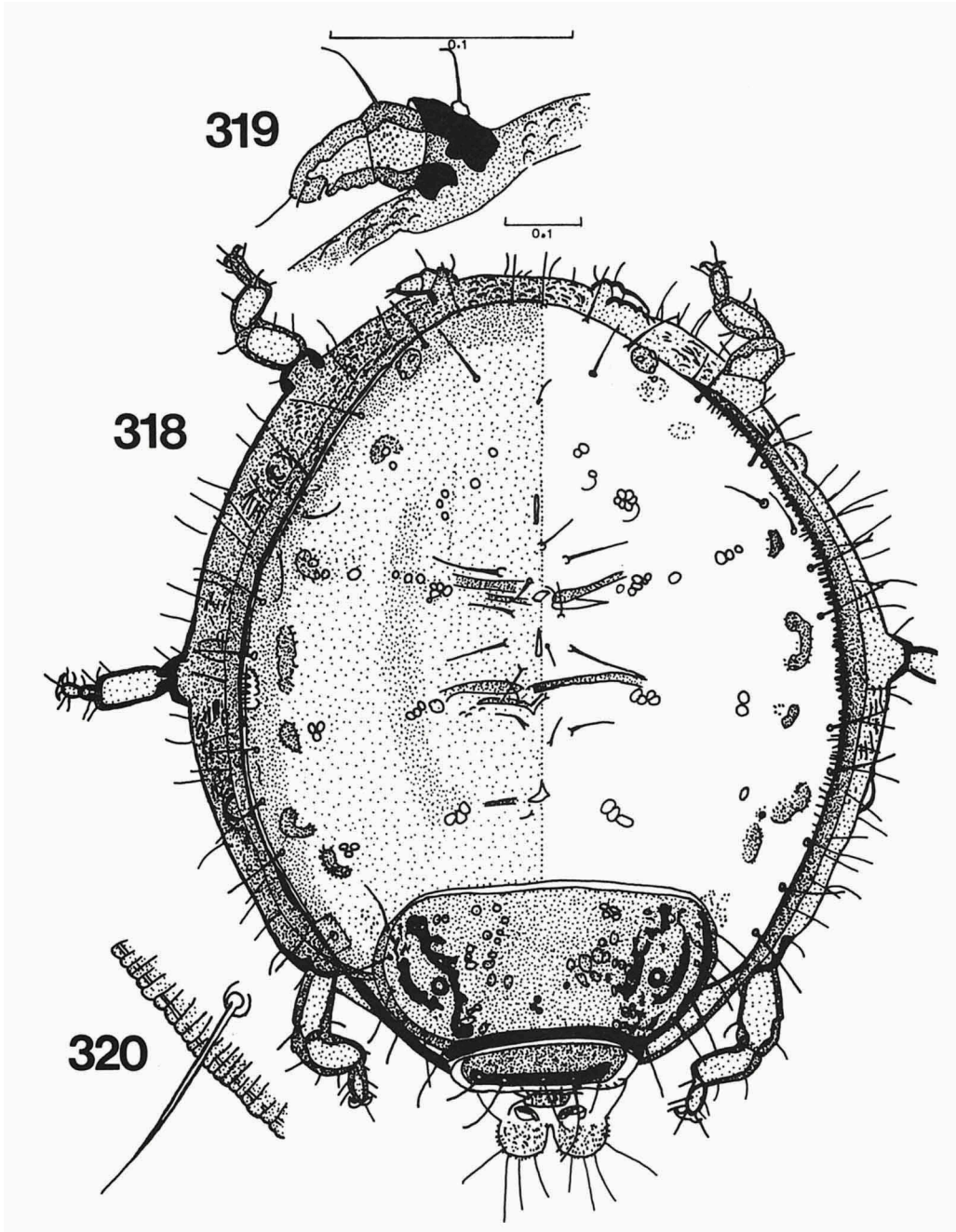
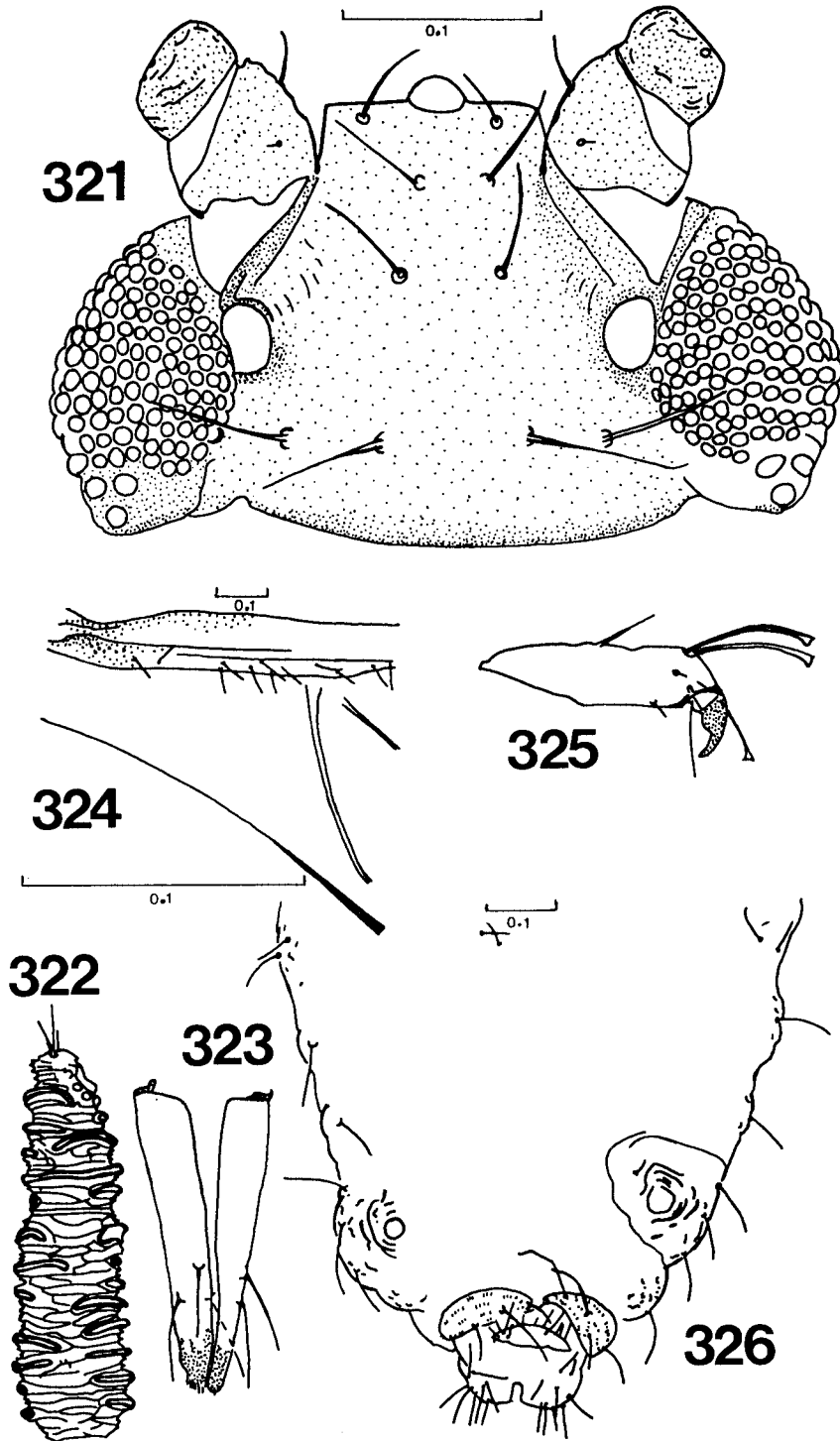

Fig. 317. *Glyphinaphis bambusae* Van der Goot, first stage larva of apterous viviparous ♀.



Figs. 318-320. *Mesothoracaphis rappardi* (Hille Ris Lambers and Takahashi), apterous viviparous ♀. Fig. 318, dorsal side of the body. Fig. 319, antenna. Fig. 320, margin of the prosoma. Scale line on top to figs. 319-320.





Figs. 321-326. *Mesothoracaphis rappardi* (Hille Ris Lambers and Takahashi), alate viviparous ♀. Fig. 321, dorsal side of the head. Fig. 322, dorsal side of antennal segment V. Fig. 323, ultimate rostral segment. Fig. 324, basal part of the fore wing. Fig. 325, second tarsal segment of the hind leg. Fig. 326, dorsal sides of abdominal segments I-VIII.

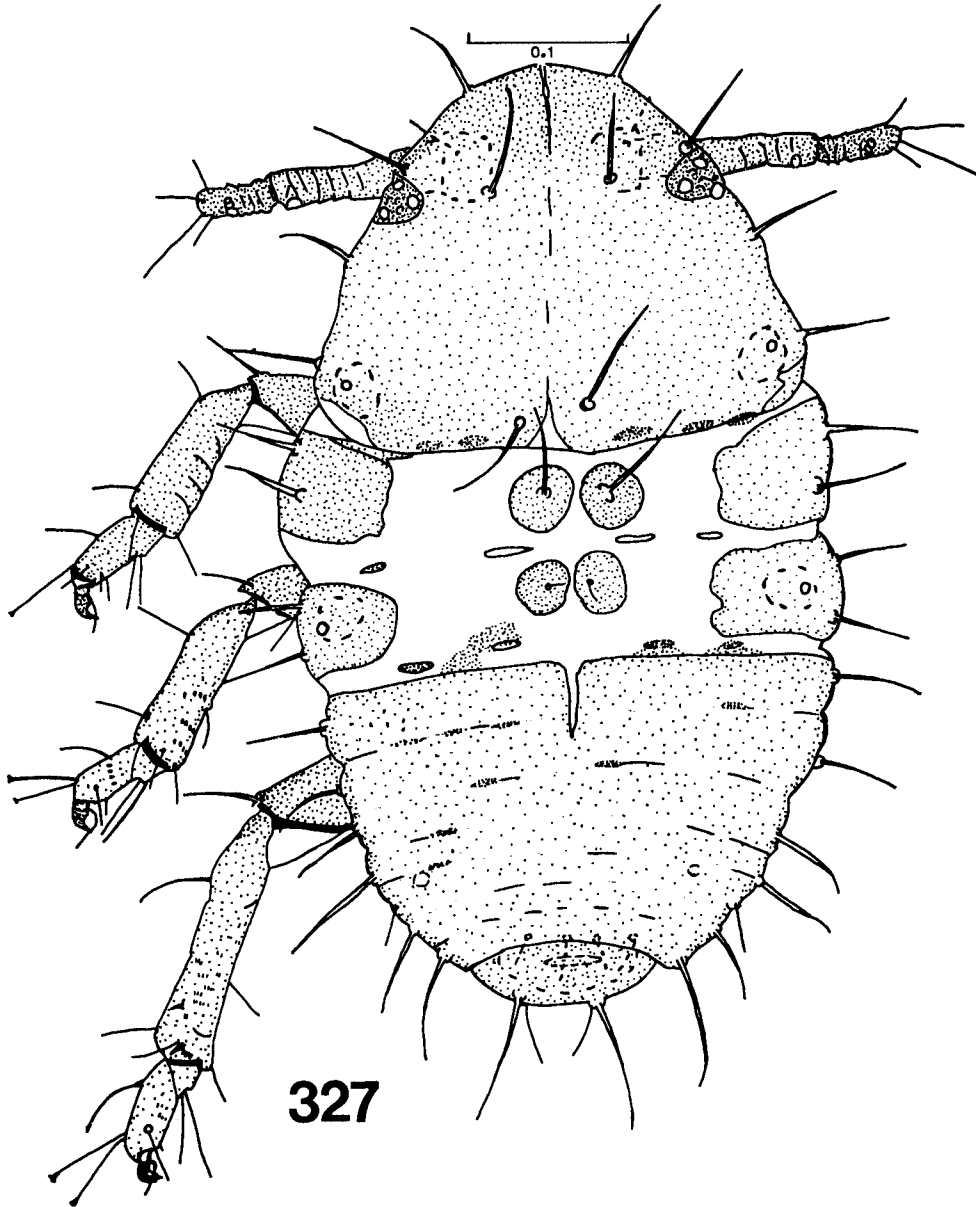
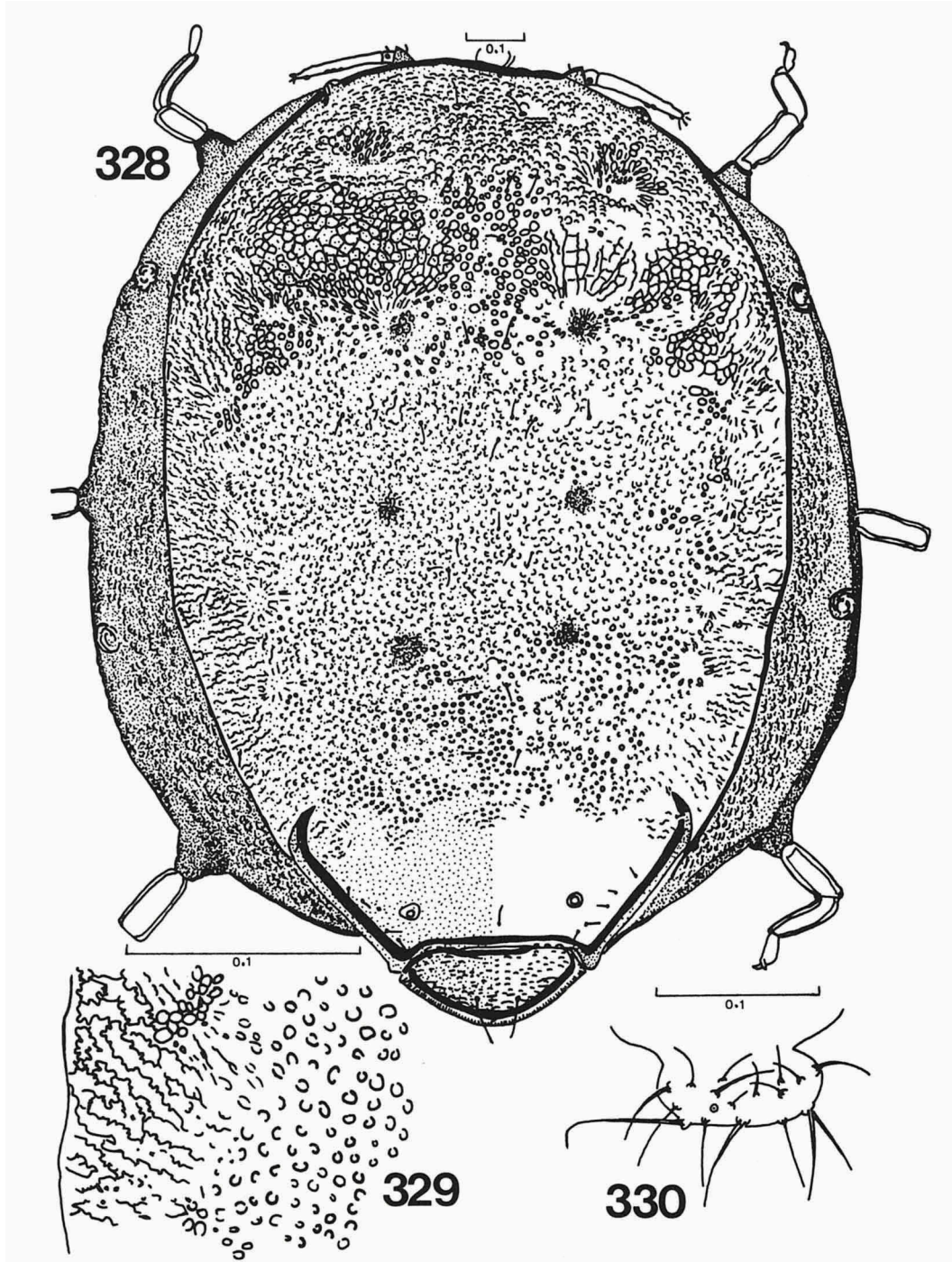
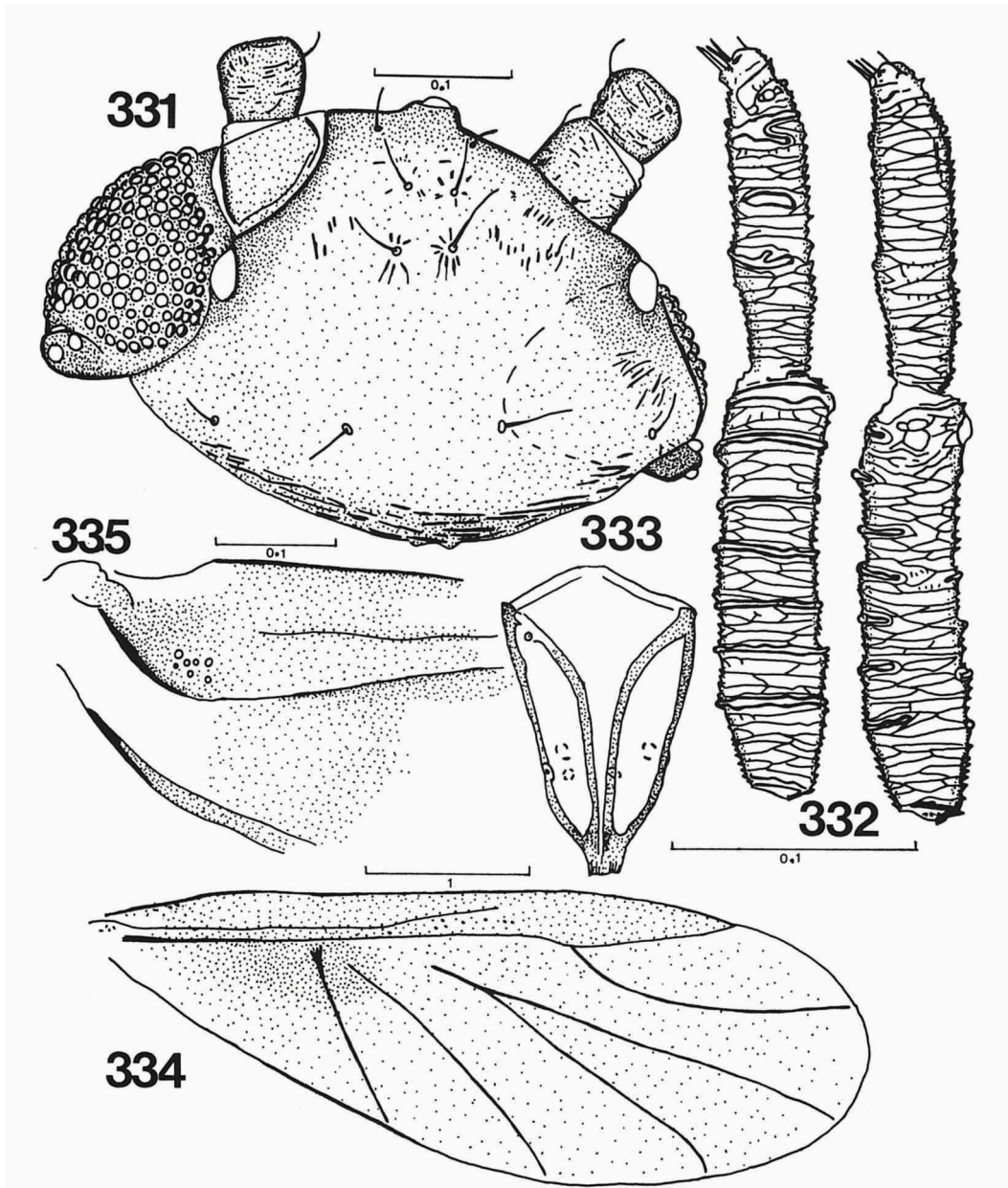

Fig. 327. *Mesothoracaphis rappardi* (Hille Ris Lambers and Takahashi), first stage larva, normal, dorsal side.



Figs. 328-330. *Metanipponaphis vandergooti* spec. nov., apterous viviparous ♀. Fig. 328, dorsal side of the body. Fig. 329, dorsal structure of the margin of the metathorax. Fig. 330, cauda.



Figs. 331-335. *Metanipponaphis vandergooti* spec. nov., alate viviparous ♀. Fig. 331, dorsal side of the head. Fig. 332, ventral (left) and dorsal (right) side of antennal segments IV-V. Fig. 333, ultimate rostral segment. Fig. 334, fore wing. Fig. 335, base of the fore wing.

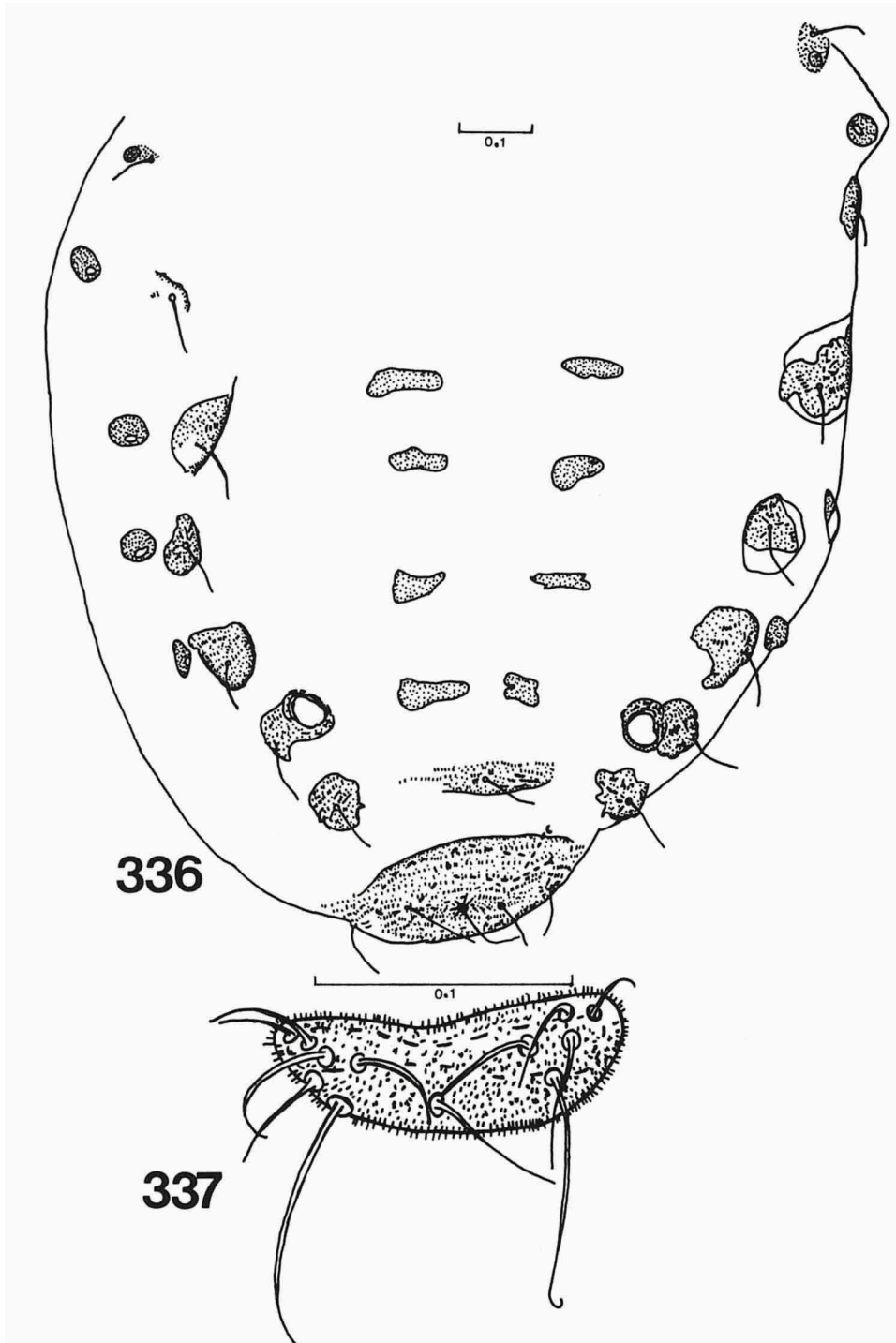

Figs. 336-337. *Metanipponaphis vanderhooti* spec. nov., alate viviparous ♀. Fig. 336, dorsal sides of abdominal segments I-VIII. Fig. 337, cauda.

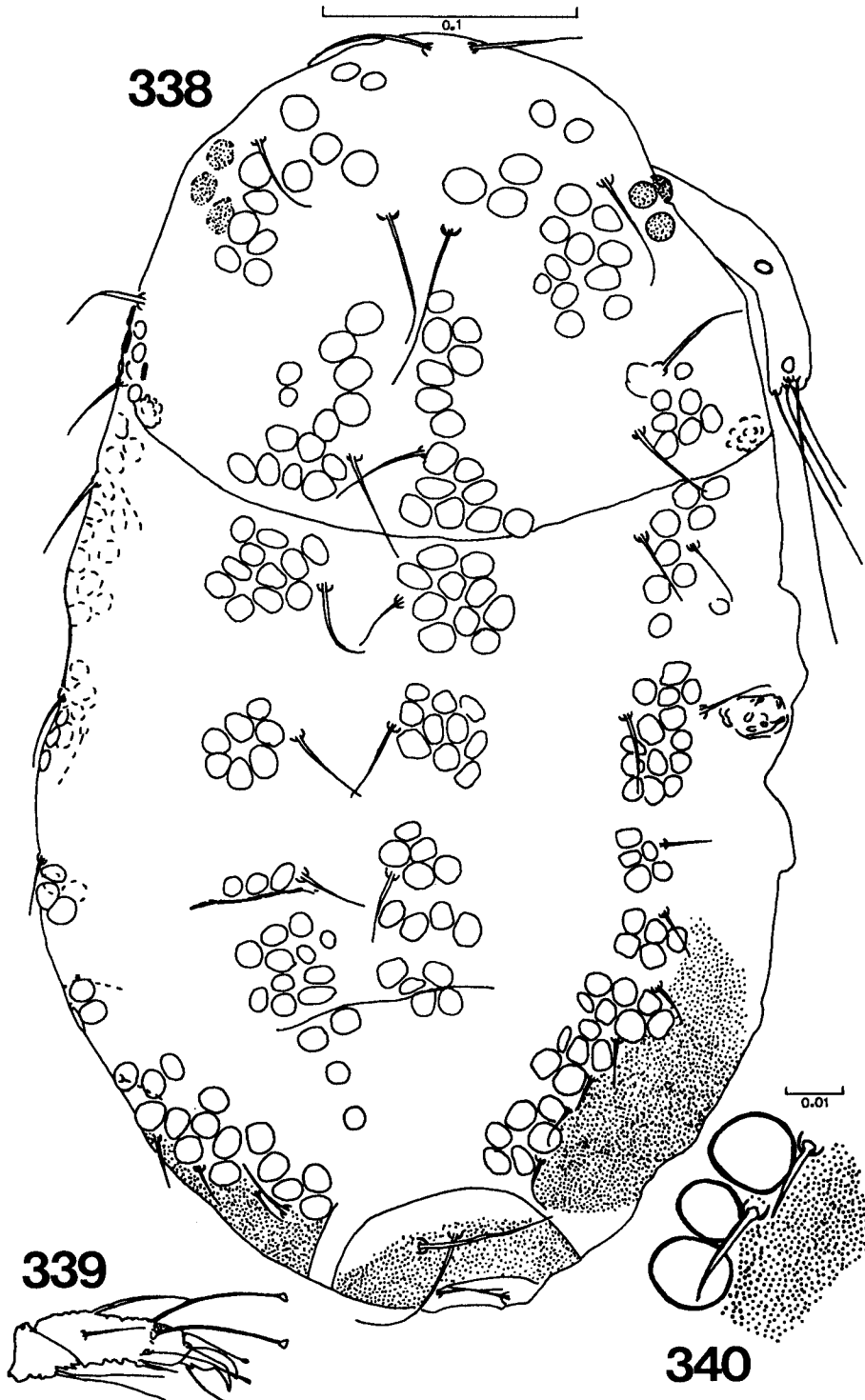

Figs. 338-340. *Metanipponaphis vandergooti* spec. nov., embryo inside apterous viviparous ♀. Fig. 338, dorsal side of the body; speckled are areas with dots. Fig. 339, second tarsal segment of the hind leg. Fig. 340, marginal area of abdominal segments VI-VII with wax glands and dots. Scale line 0.1 to figs. 338-339.



Figs. 341-342. *Metanipponaphis vandergooti* spec. nov., last stage larva of alate viviparous ♀. Fig. 341, dorsal side of the body. Fig. 342, pustules with irregular outline.

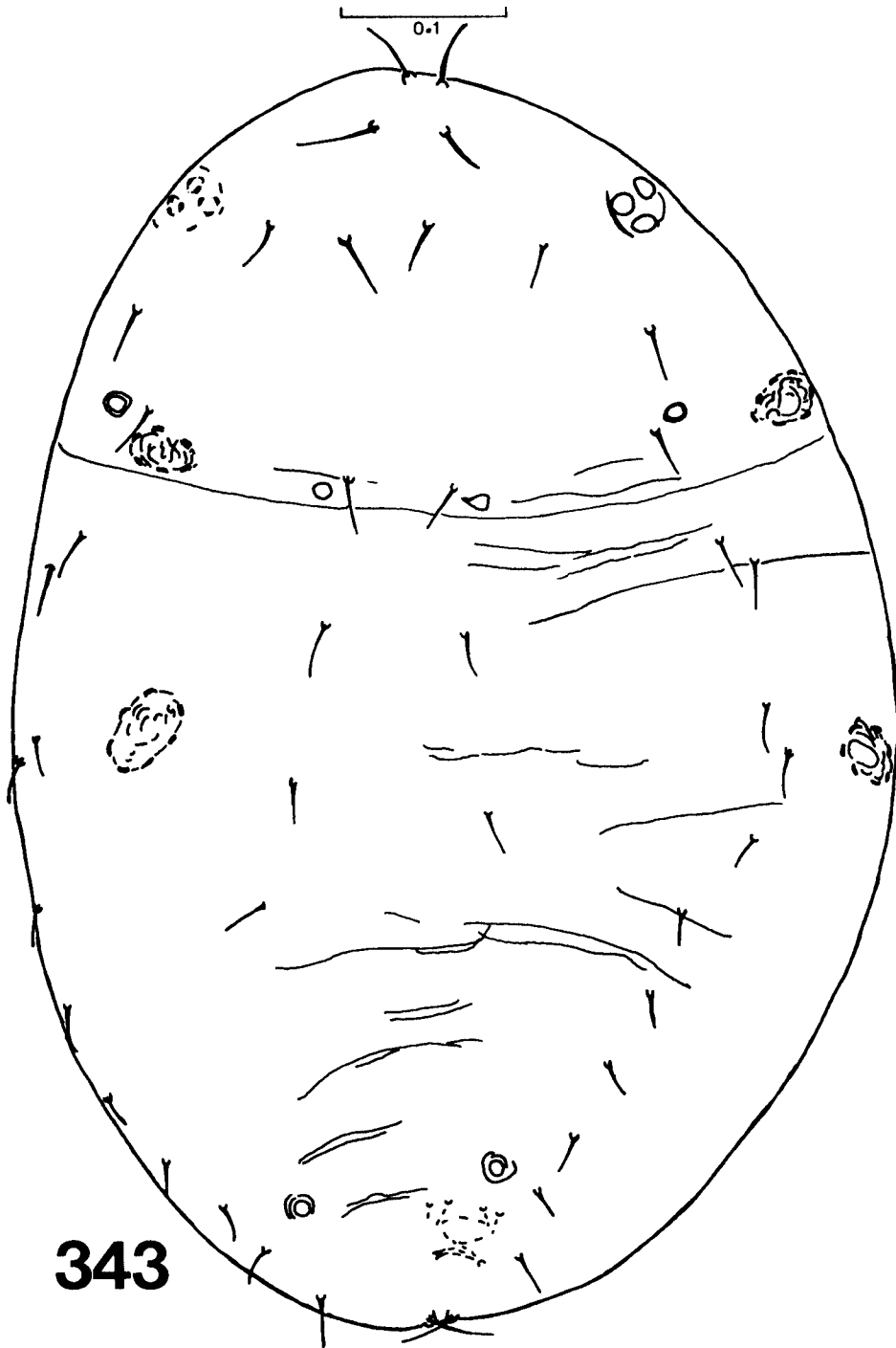

Fig. 343. *Metanipponaphis vandergooti* spec. nov., embryo inside alate viviparous ♀, dorsal side.



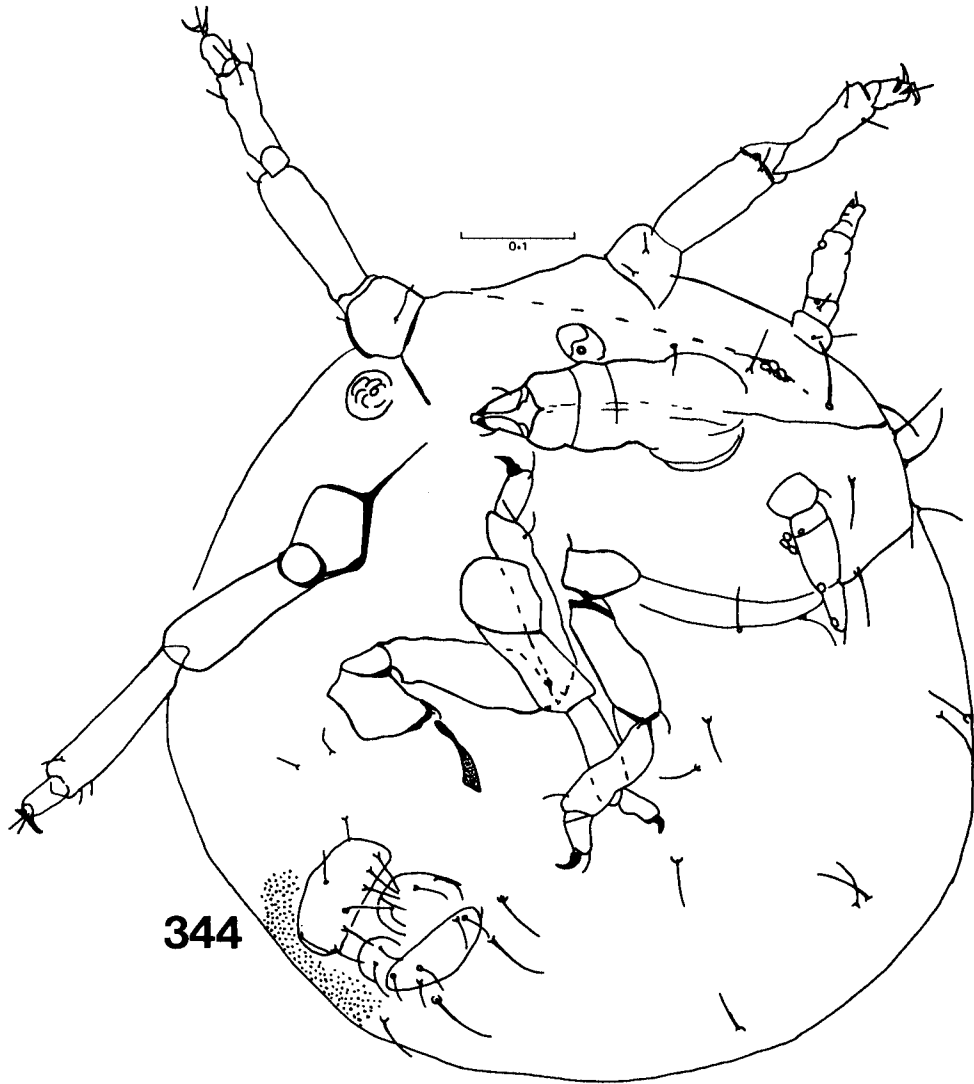
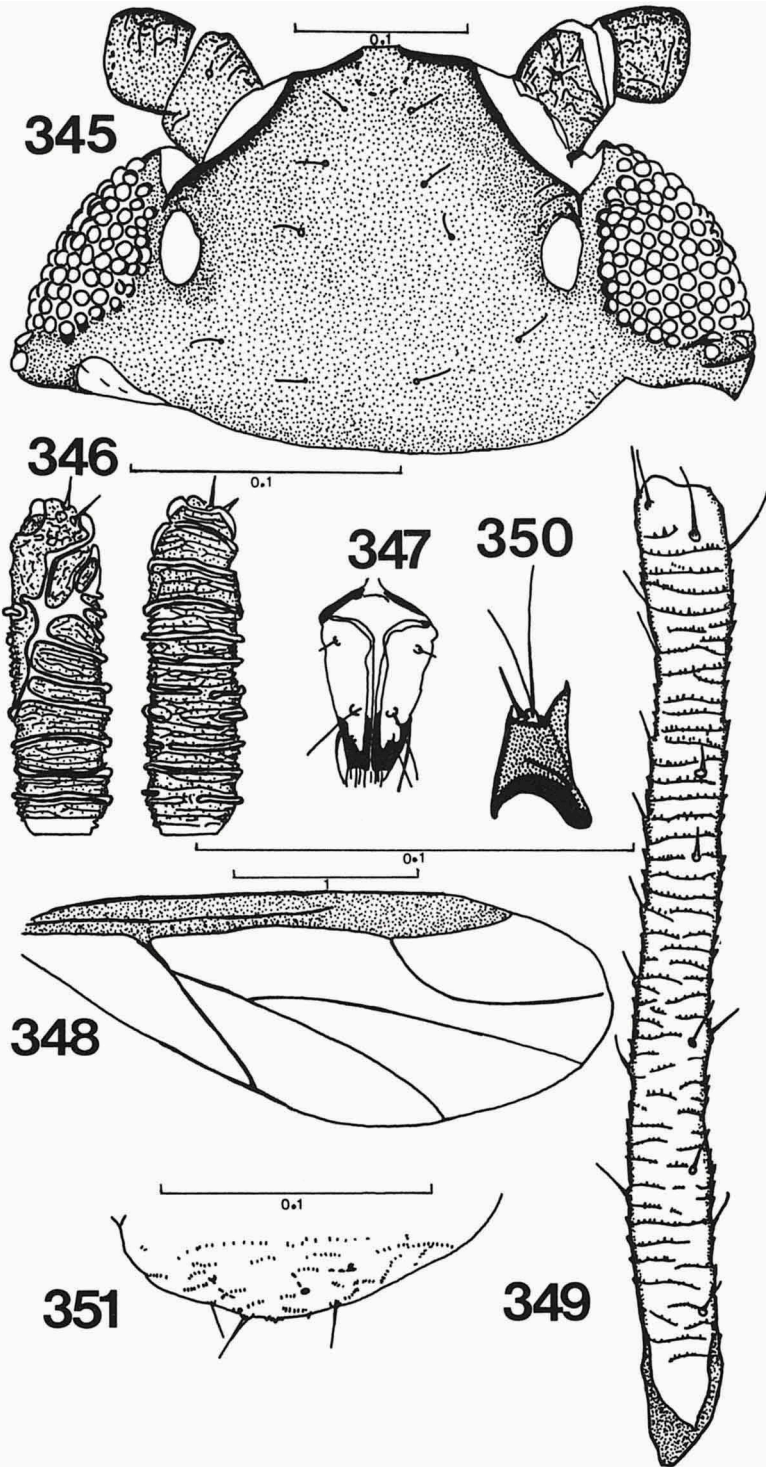
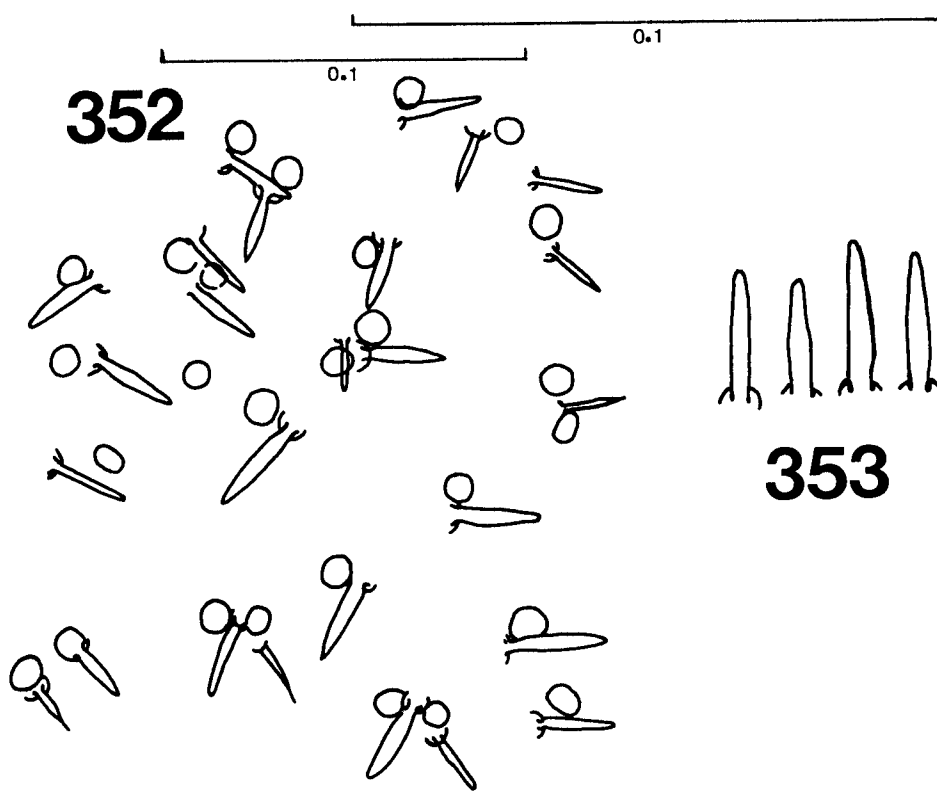

Fig. 344. *Neohormaphis calva* spec. nov., apterous viviparous ♀ from gall of *Distylium stellare*, posterior part of the abdomen with dots.



Figs. 345-351. *Neohormaphis calva* spec. nov., alate viviparous ♀ from gall of *Distylium stellare*. Fig. 345, dorsal side of the head. Fig. 346, ventral (left) and dorsal (right) side of antennal segment V. Fig. 347, ultimate rostral segment. Fig. 348, fore wing. Fig. 349, tibia of the foreleg. Fig. 350, first tarsal segment of the hind leg. Fig. 351, cauda.



Figs. 352-353. *Neohormaphis calva* spec. nov., embryo inside alate viviparous ♀ from gall of *Distylium stellare*. Fig. 352, hairs and circular organs. Fig. 353, four separate hairs.

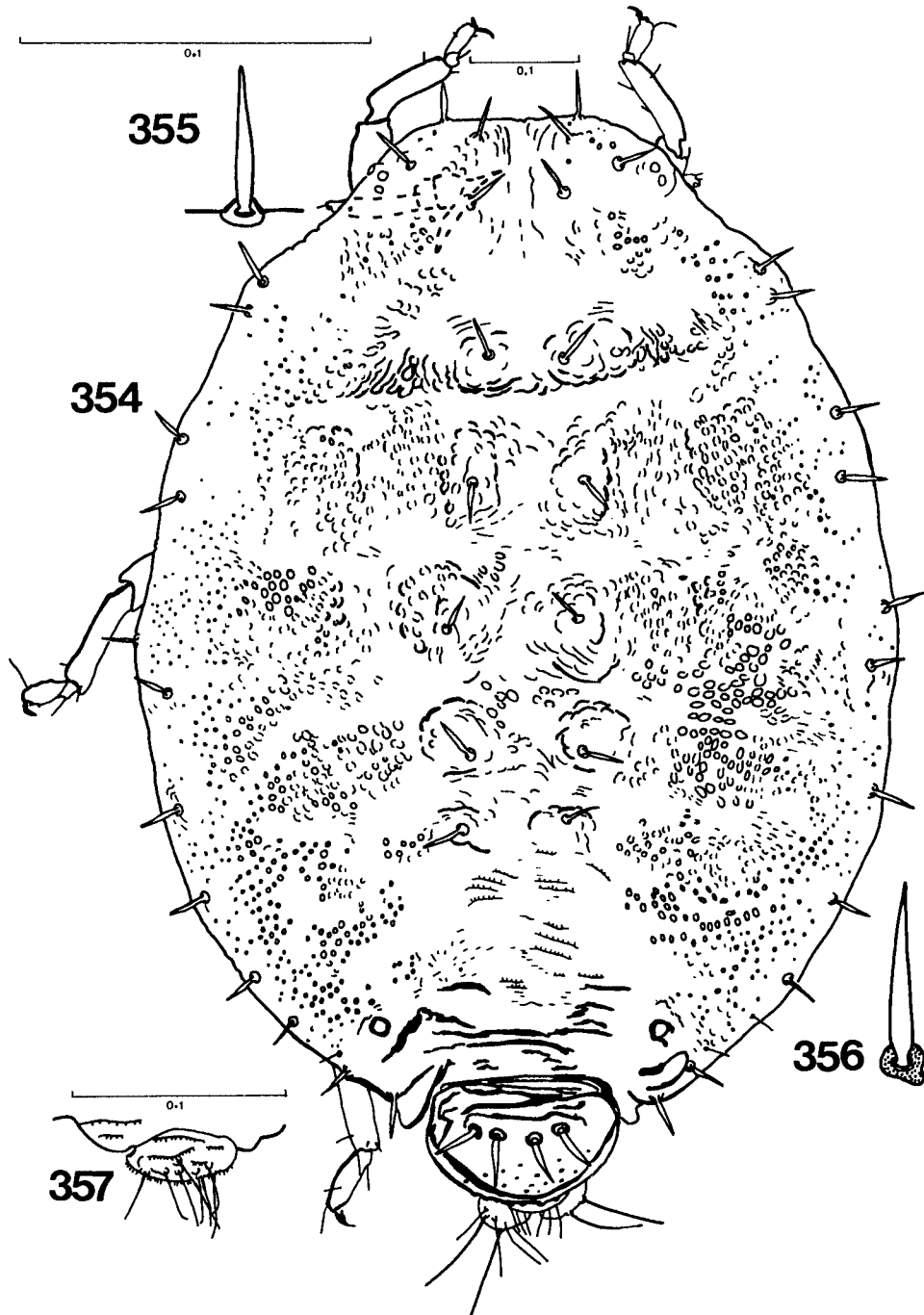

Figs. 354-357. *Neohormaphis calva* spec. nov., apterous viviparous ♀ from *Quercus*: Fig. 354, dorsal side of the body. Fig. 355, marginal hair. Fig. 356, hair of an abdominal tergite. Fig. 357, alate viviparous ♀ from *Quercus*, cauda.

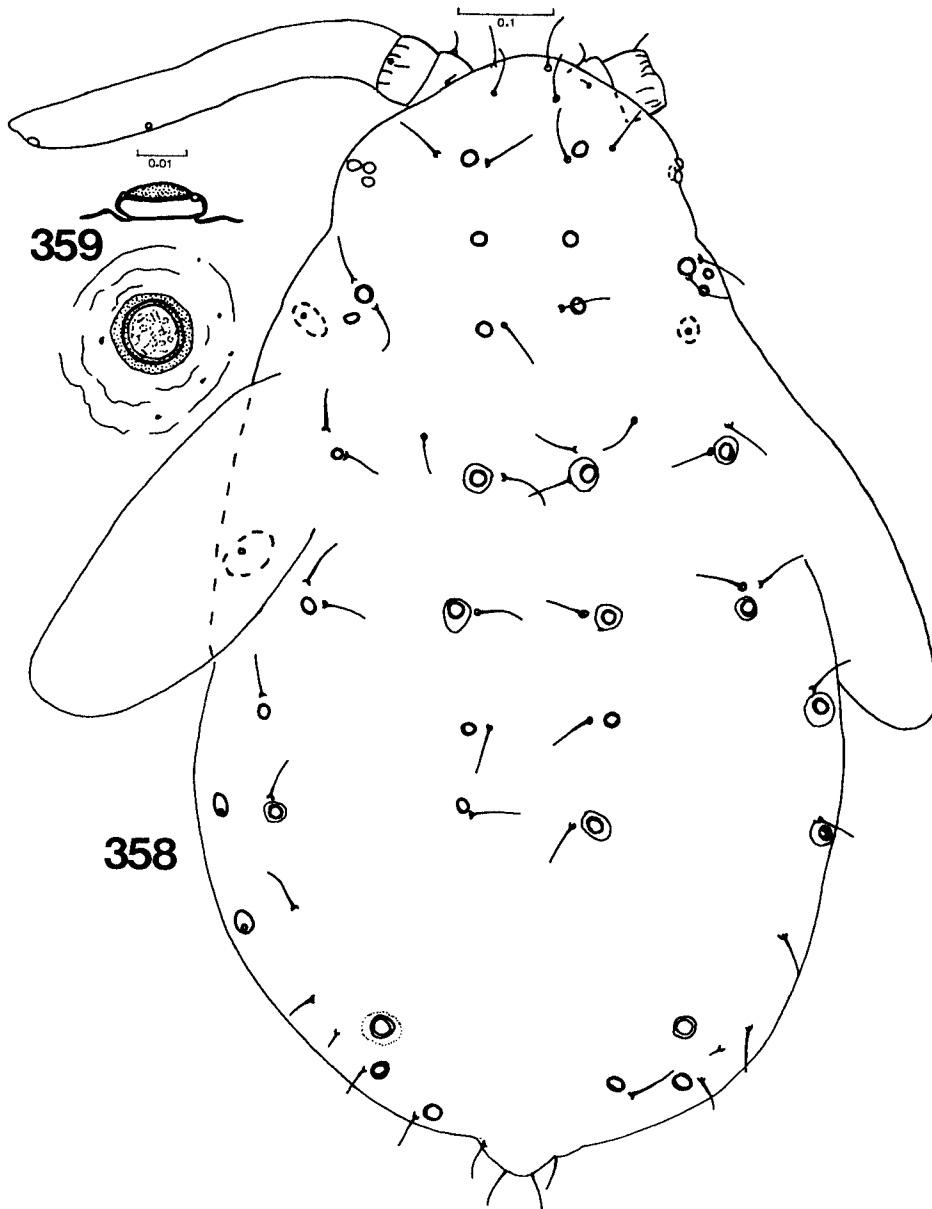

Figs. 358-359. *Neohormaphis calva* spec. nov., last stage larva of alate viviparous ♀ from *Quercus*. Fig. 358, dorsal side of the body with hairs and button organs. Fig. 359, button organs as seen from aside and from above.

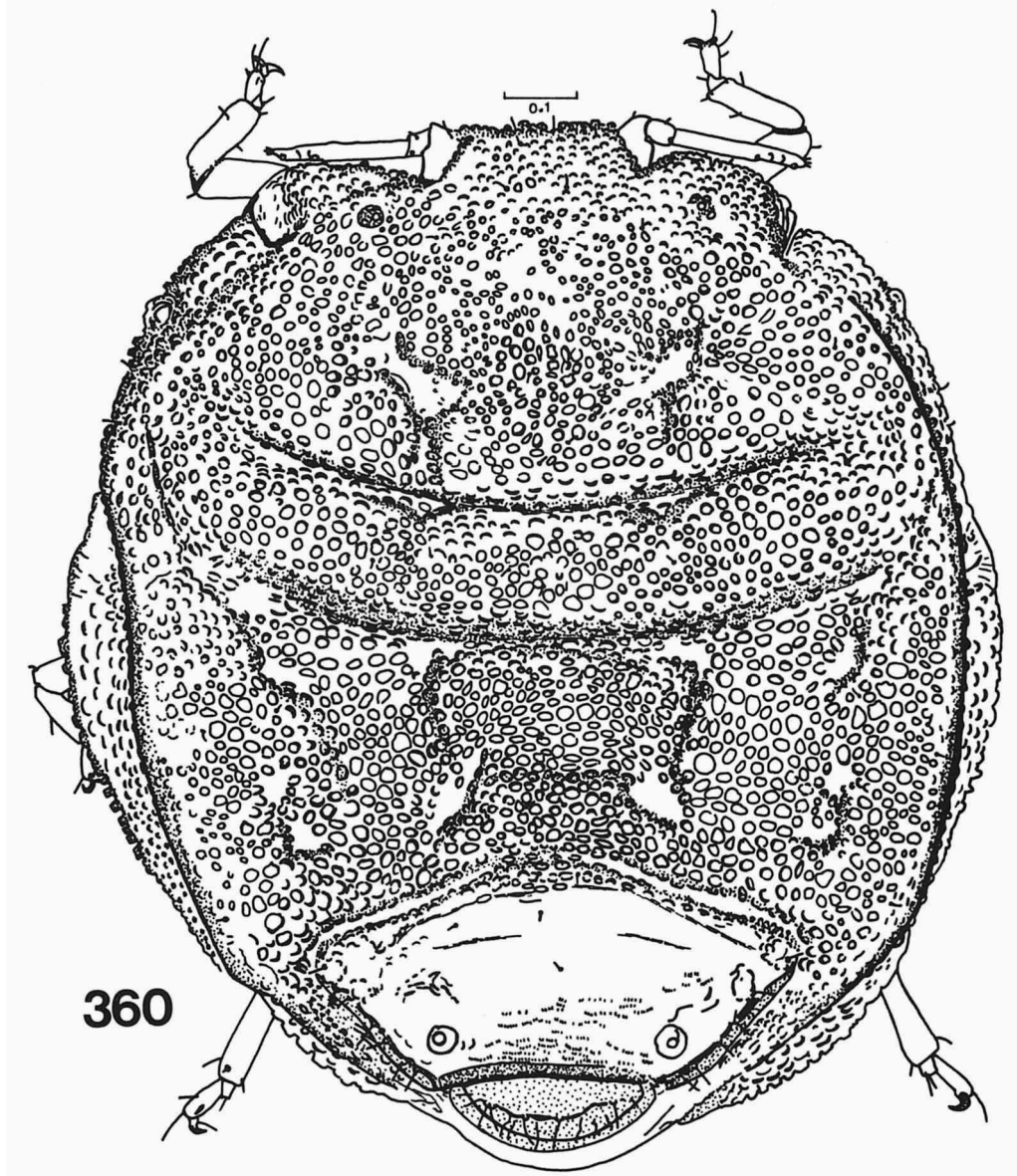
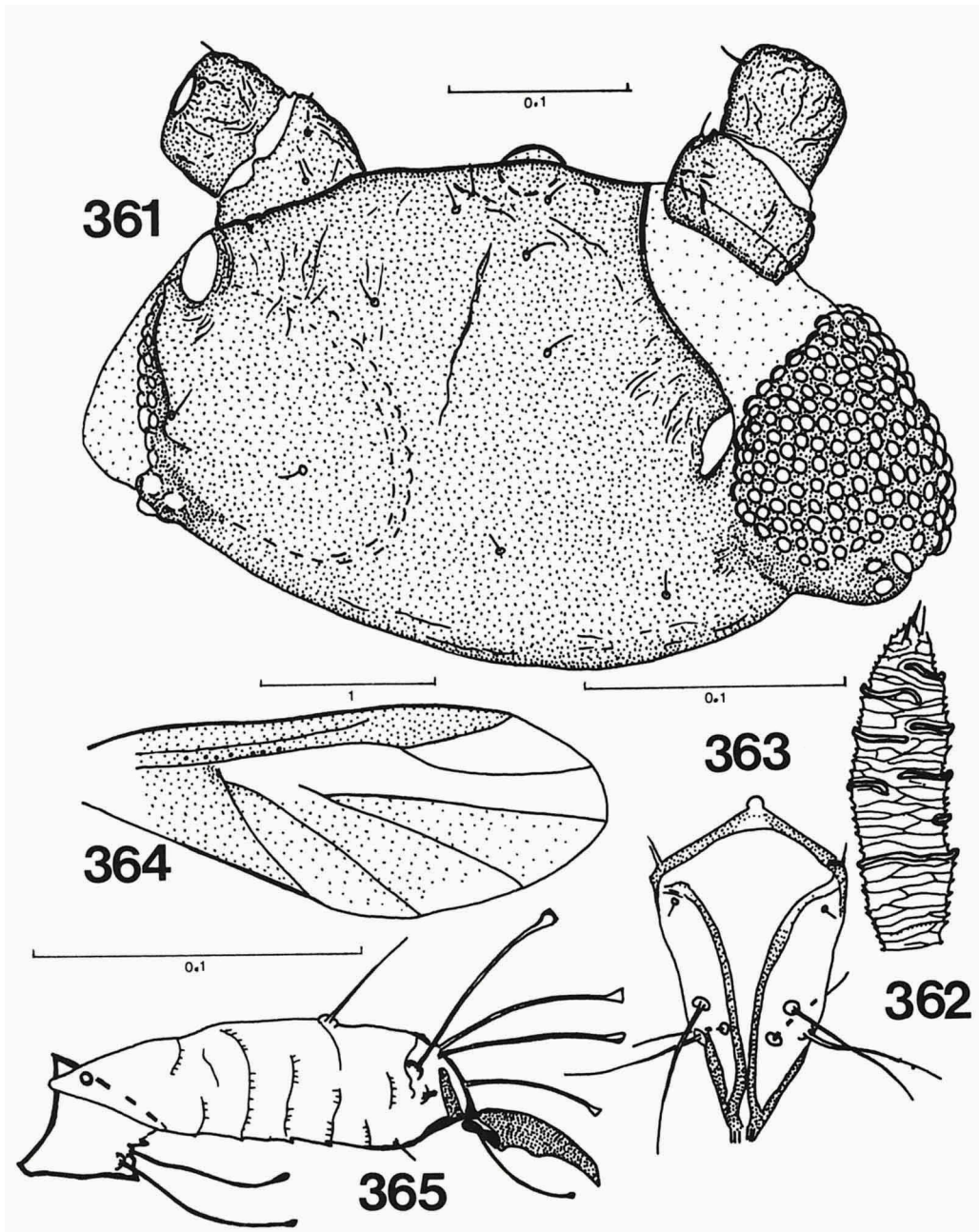
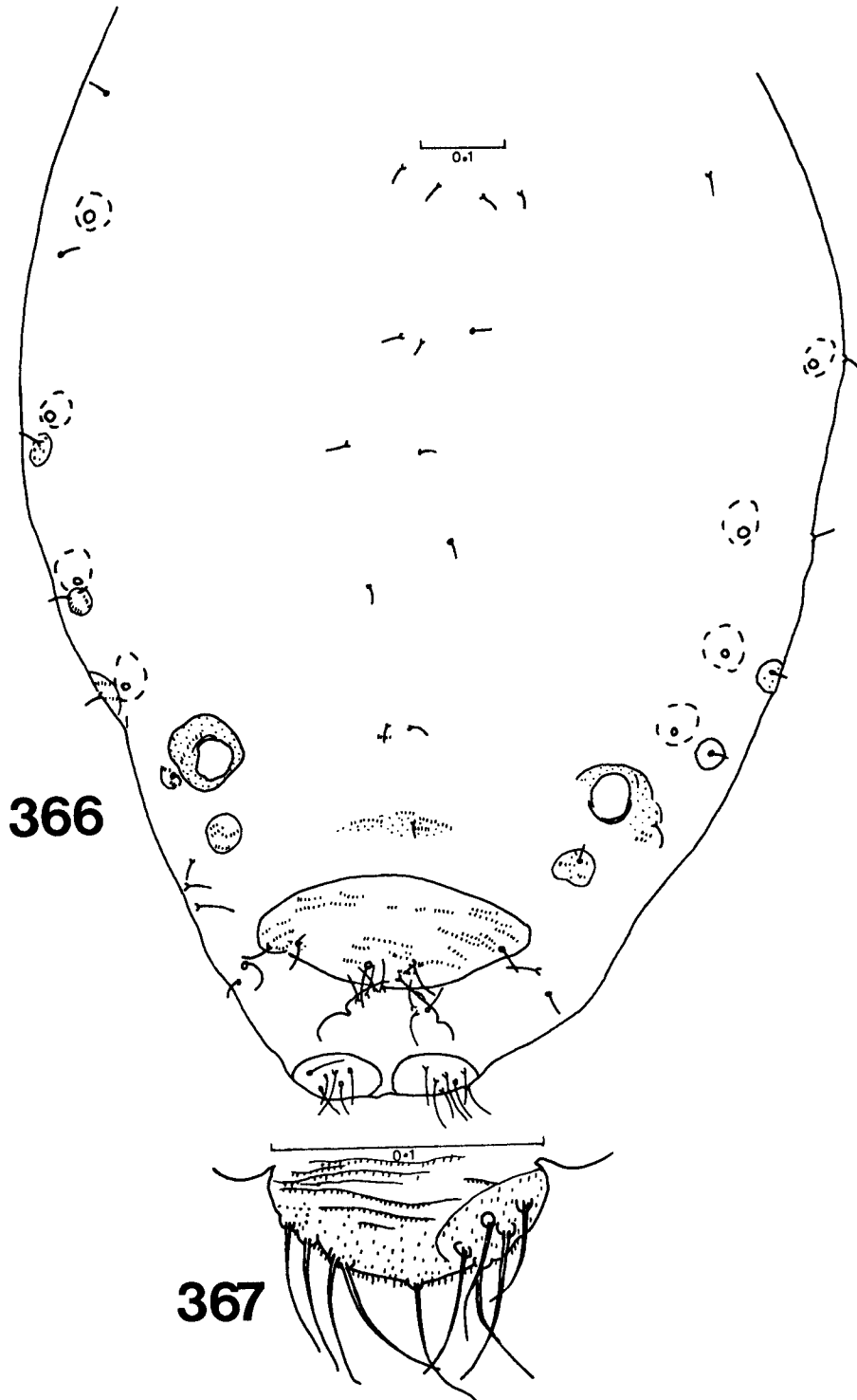

Fig. 360. *Nipponaphis brevipilosa* spec. nov., apterous viviparous ♀, dorsal side of the body.



Figs. 361-365. *Nipponaphis brevipilosa* spec. nov., alate viviparous ♀. Fig. 361, dorsal side of the head. Fig. 362, dorsal side of antennal segment V. Fig. 363, ultimate rostral segment. Fig. 364, fore wing. Fig. 365, first and second tarsal segment of the hind leg.



Figs. 366-367. *Nipponaphis brevipilosa* spec. nov., alate viviparous ♀. Fig. 366, dorsal sides of abdominal segments I-VIII. Fig. 367, cauda.



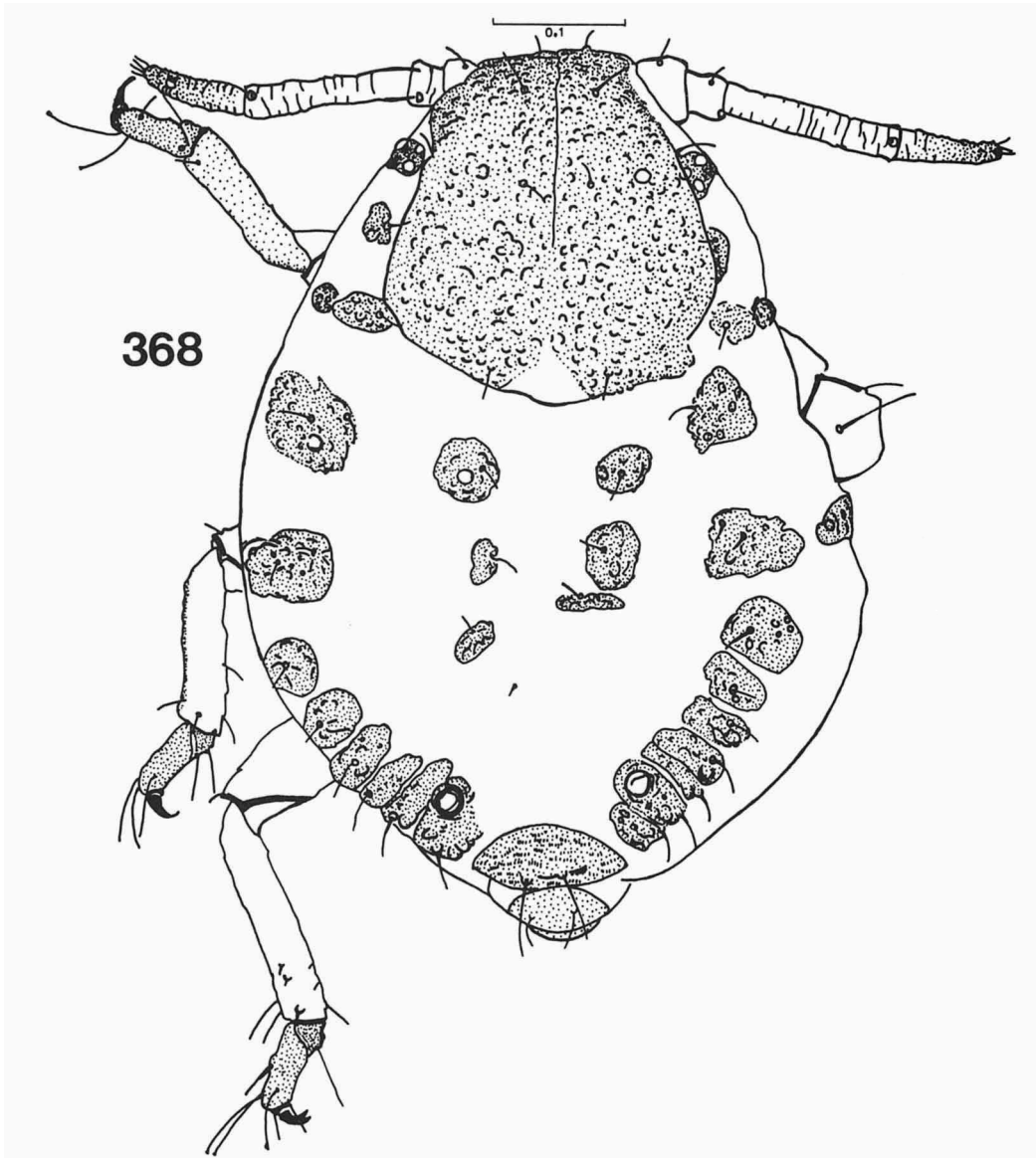

Fig. 368. *Nipponaphis brevipilosa* spec. nov., first stage larva, dorsal side of the body.

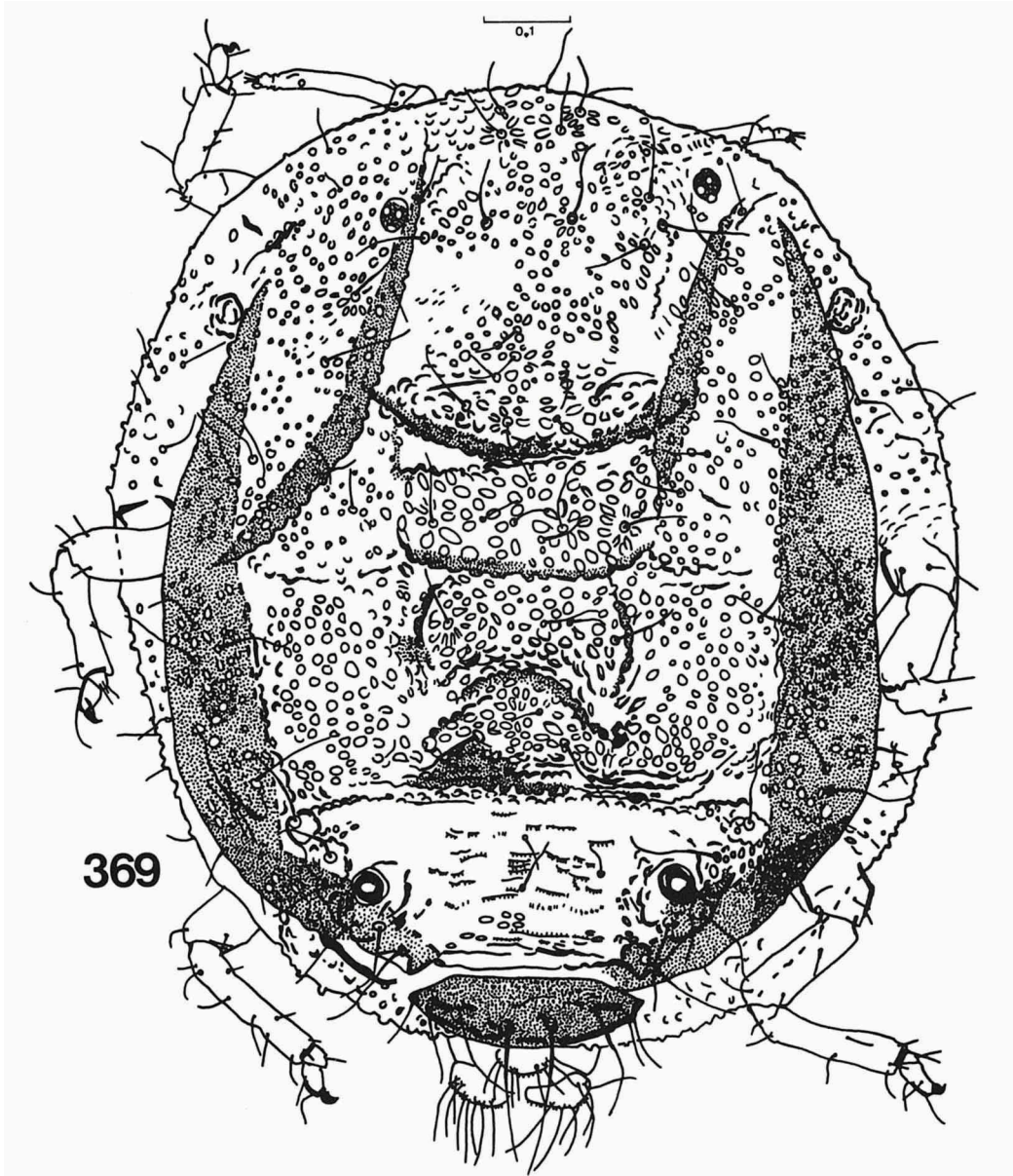

Fig. 369. *Nipponaphis ficicola* Hille Ris Lambers and Takahashi, apterous ♀, dorsal side of the body.

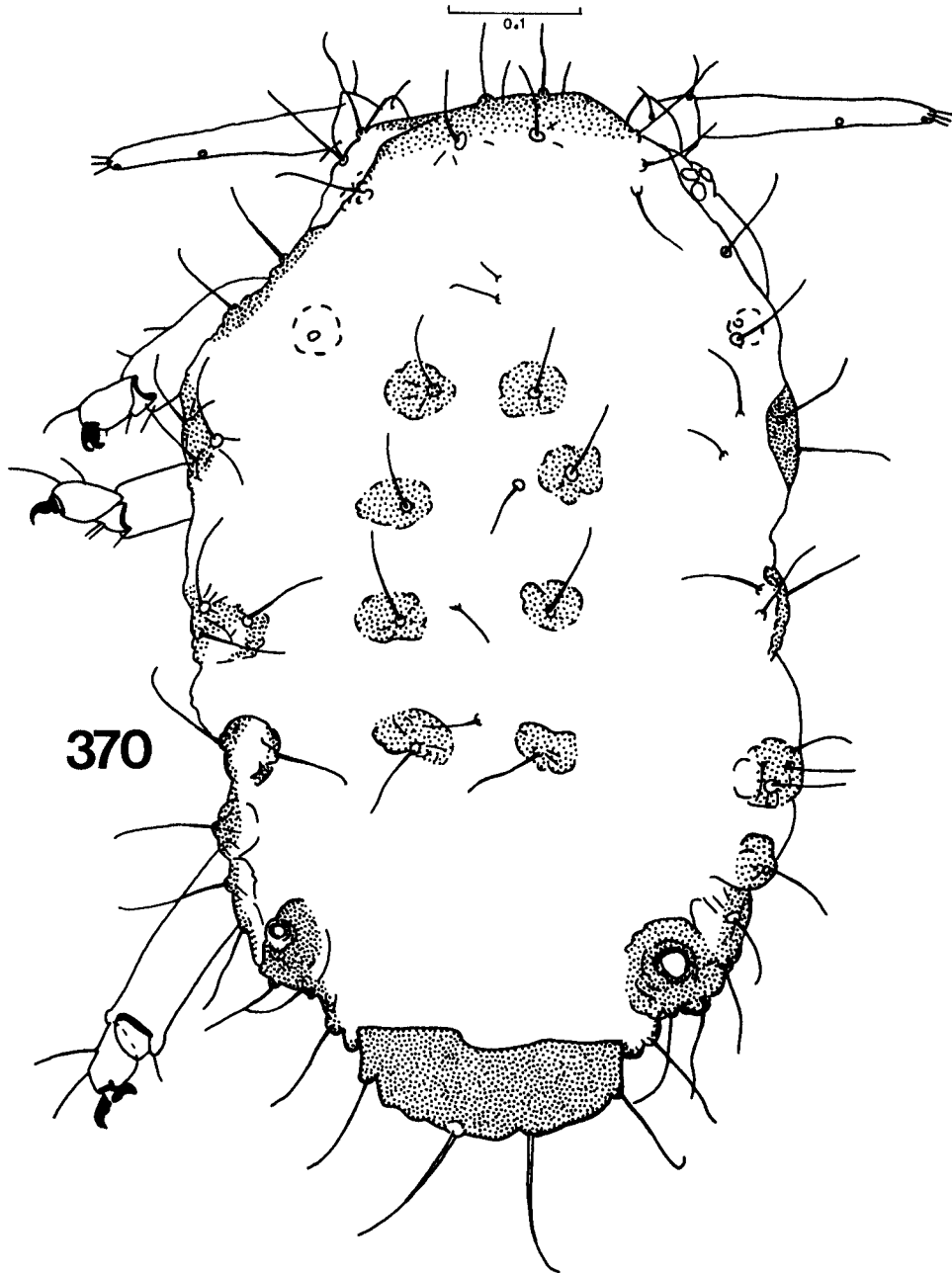

Fig. 370. *Nipponaphis ficicola* Hille Ris Lambers & Takahashi, second or third stage larva of apterous viviparous ♀, dorsal side of the body.

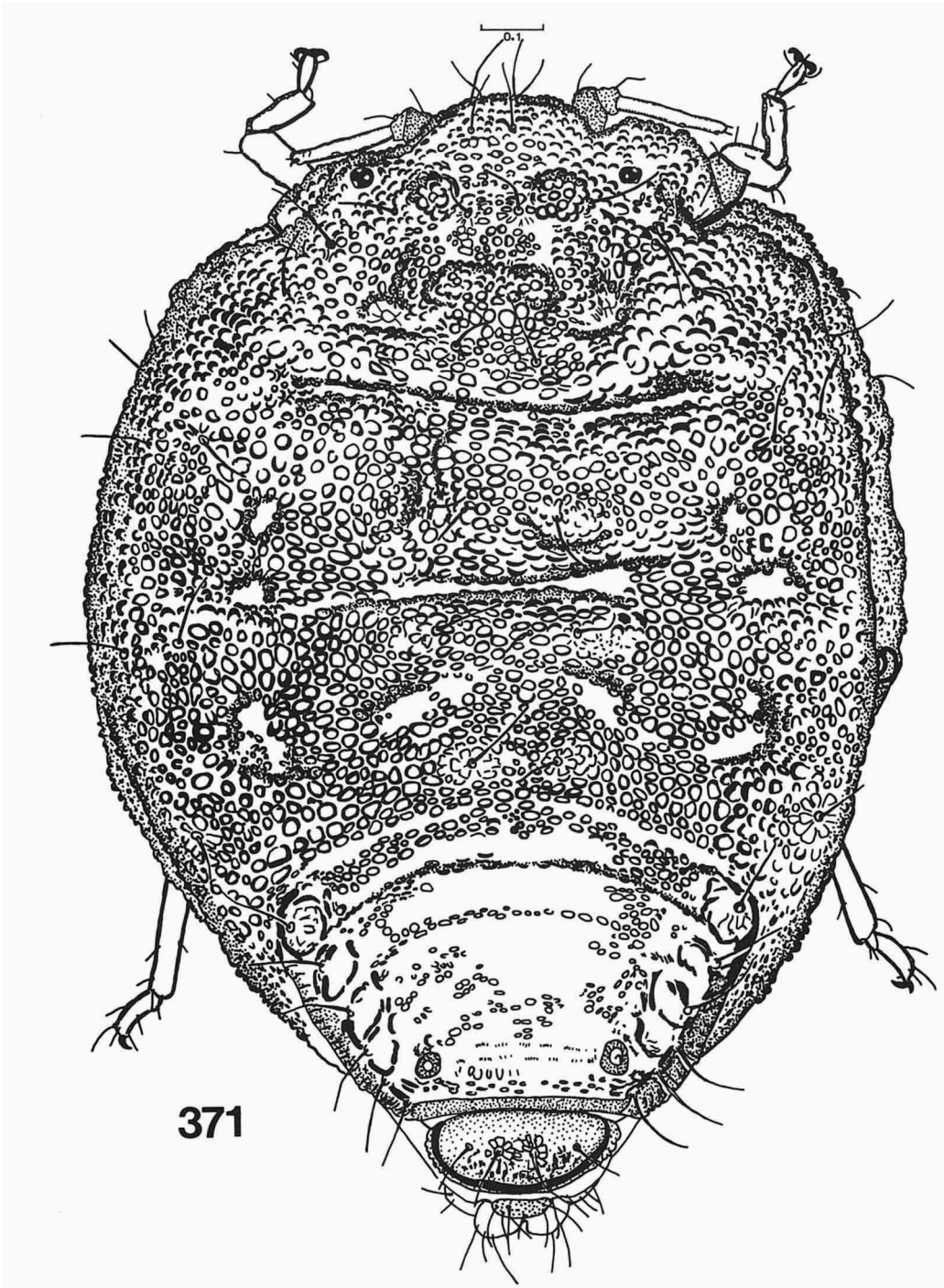
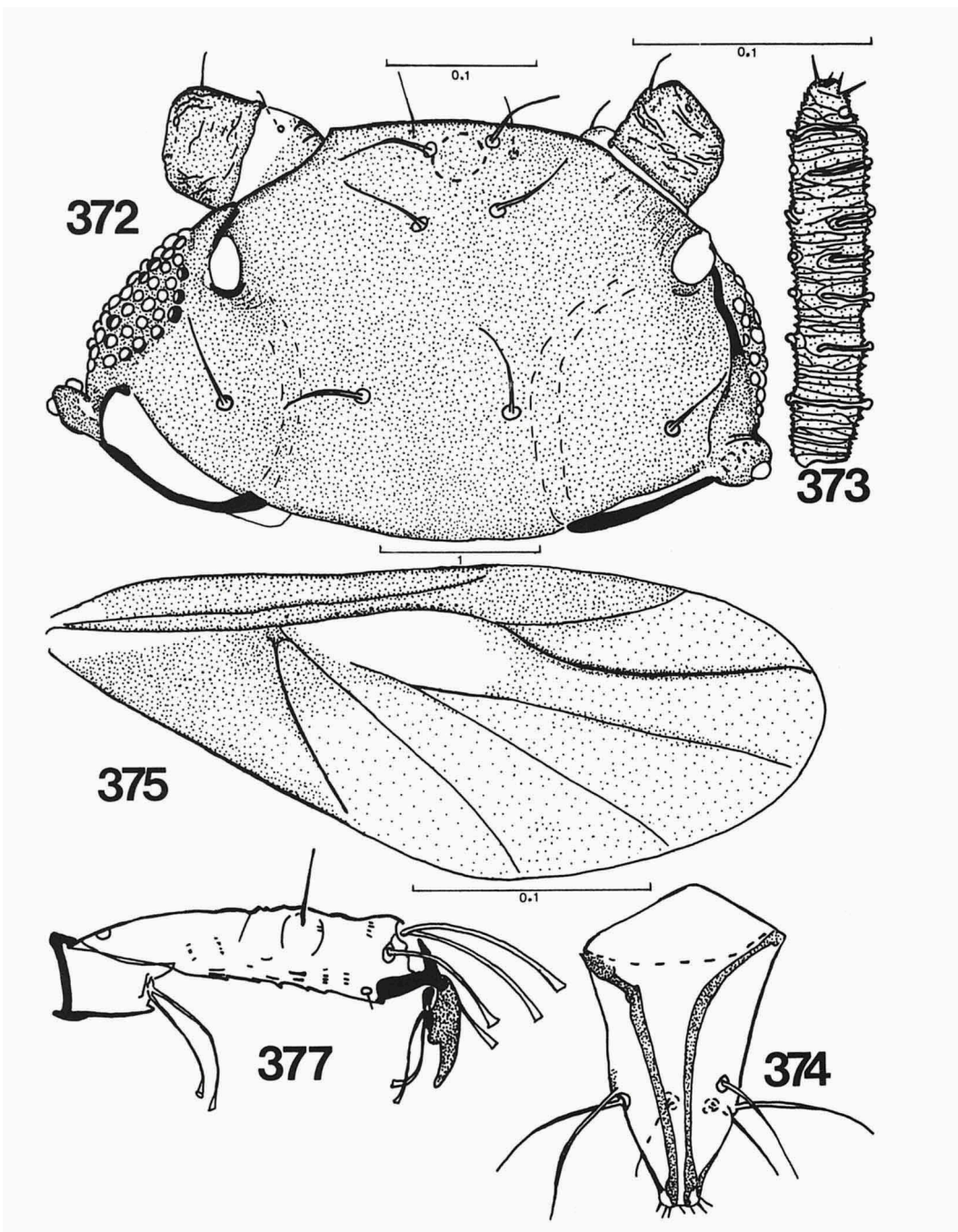
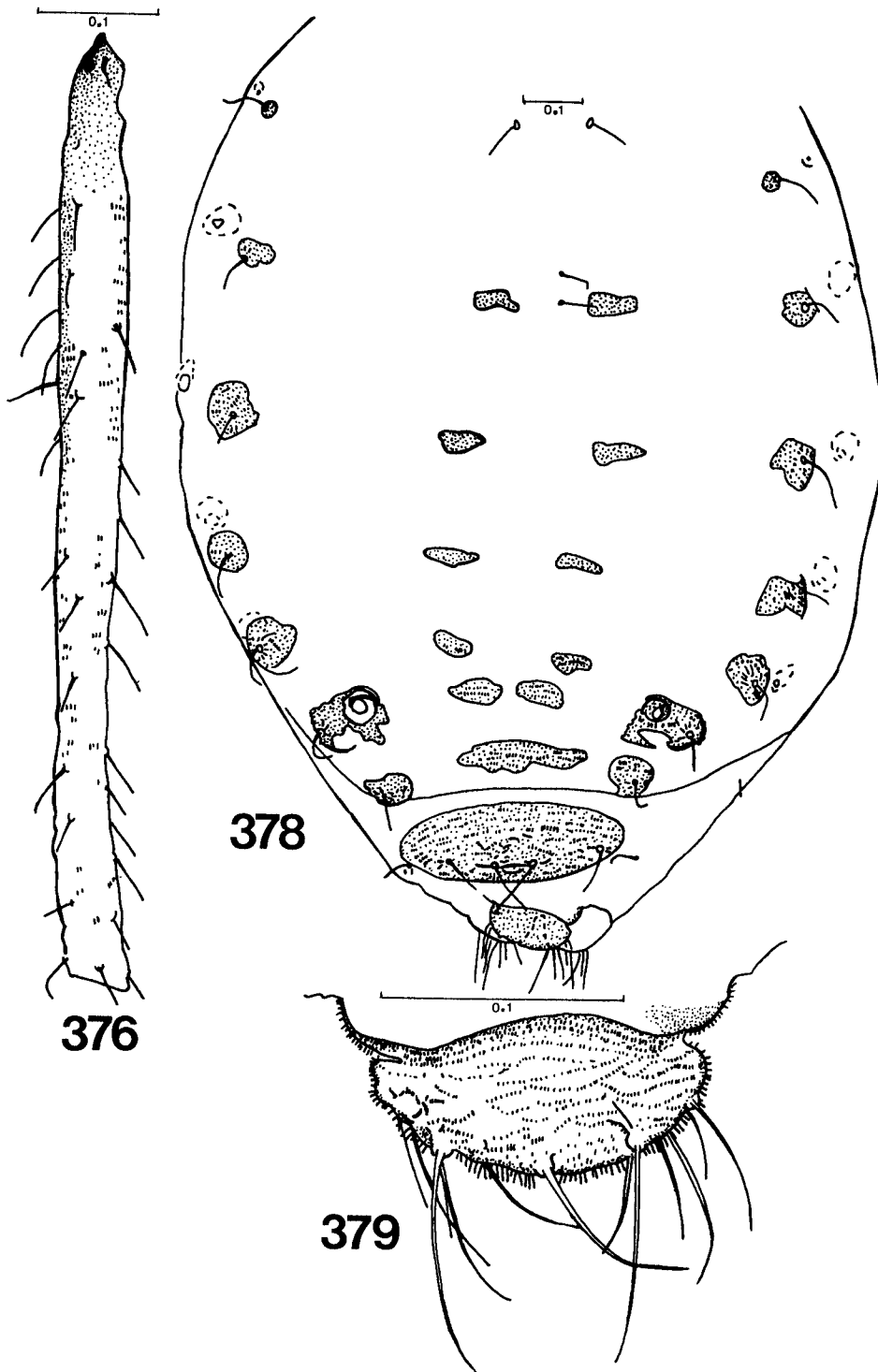

Fig. 371. *Nipponaphis javanica* spec. nov., apterous viviparous ♀, dorsal side of the body.



Figs. 372-375, 377. *Nipponaphis javanica* spec. nov., alate viviparous ♀. Fig. 372, dorsal side of the head. Fig. 373, dorsal side of antennal segment V. Fig. 374, ultimate rostral segment. Fig. 375, fore wing. Fig. 377, first and second tarsal segments of the hind leg.



Figs. 376, 378-379. *Nipponaphis javanica* spec. nov. alate viviparous ♀. Fig. 376, tibia of the hind leg. Fig. 378, dorsal sides of abdominal segments I-VIII. Fig. 379, cauda.

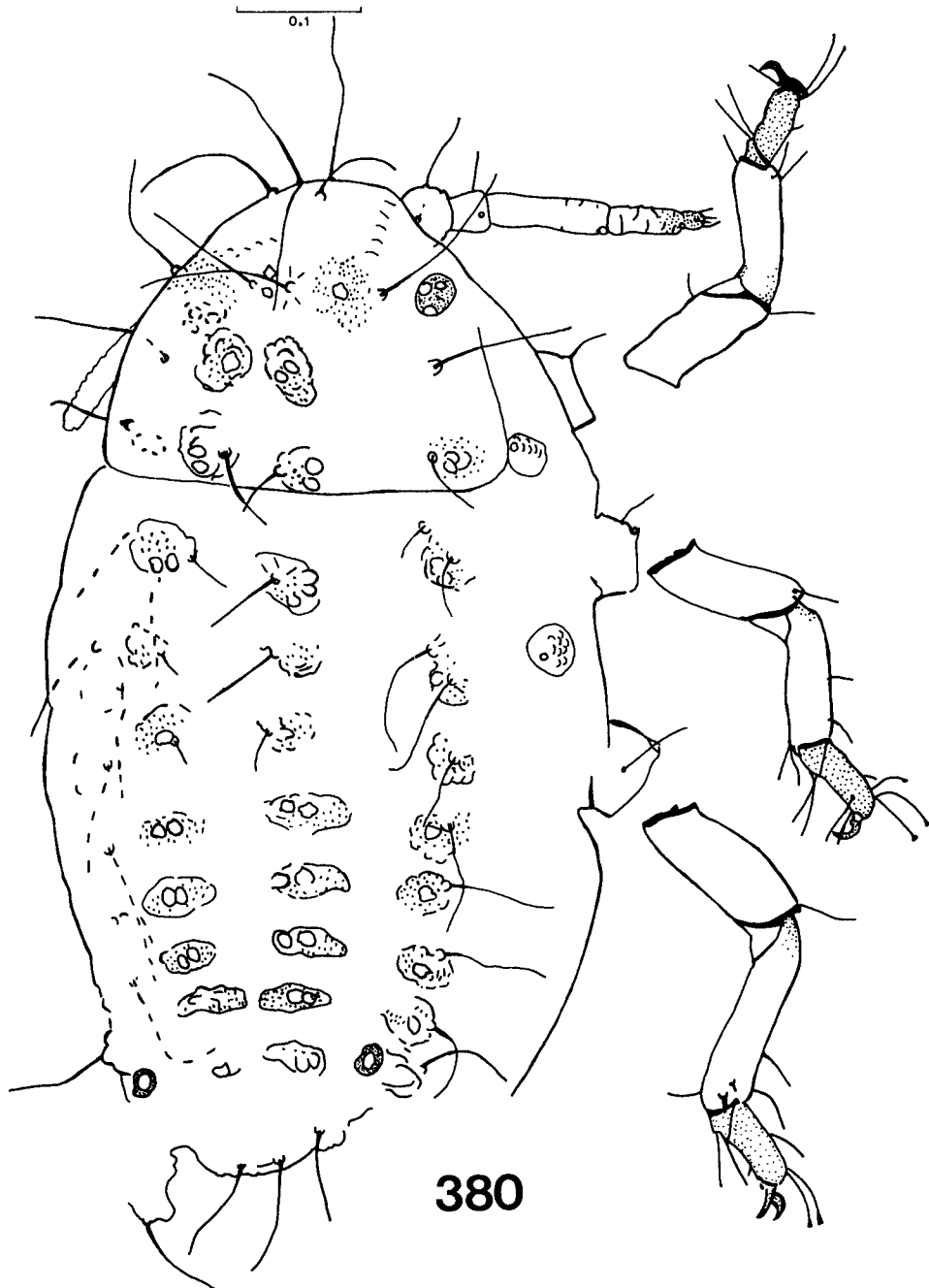

Fig. 380 *Nipponaphis javanica* spec. nov., first stage larva, dorsal side of the body.

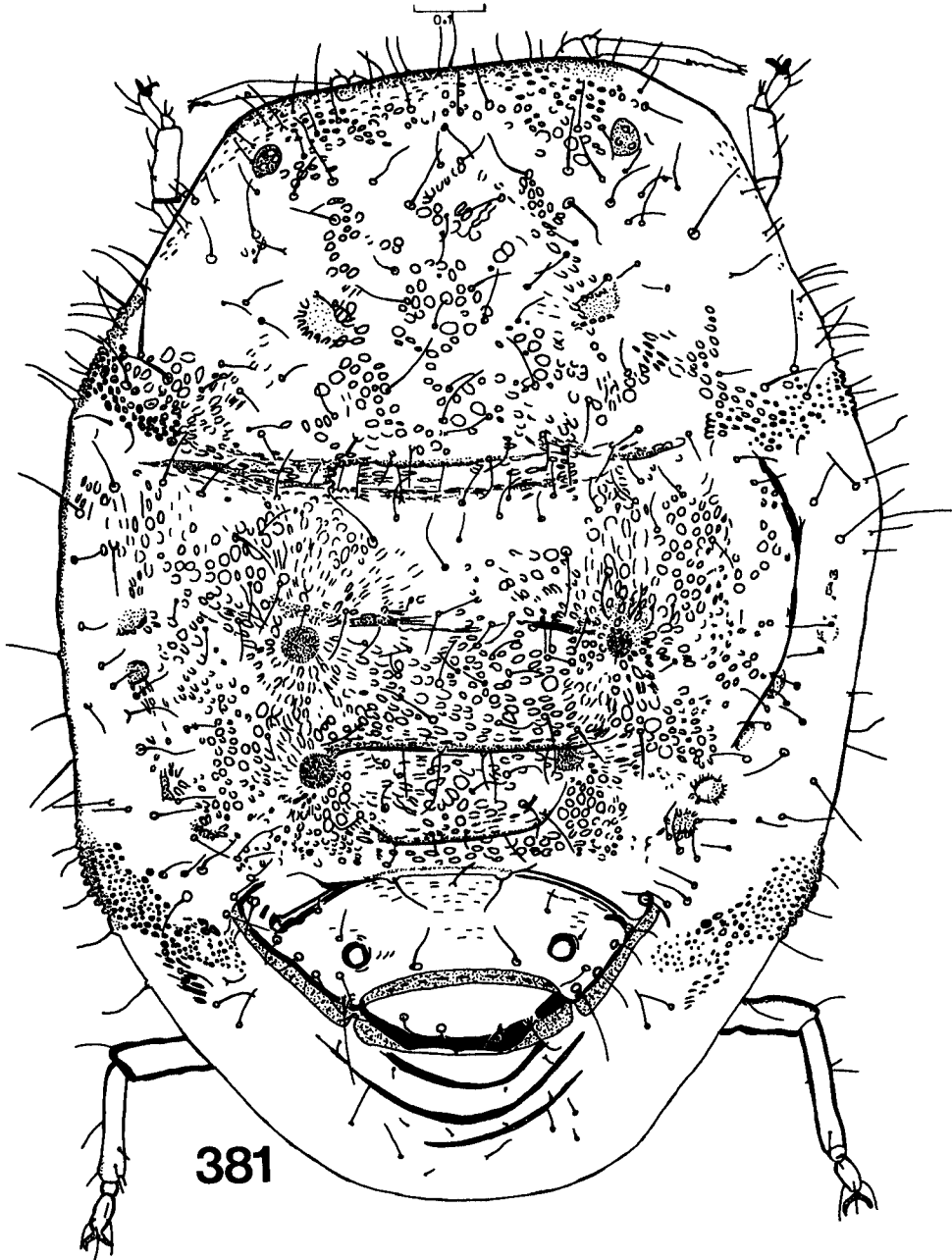

Fig. 381. *Nipponaphis multisetosa* spec. nov., apterous viviparous ♀, dorsal side of the body.



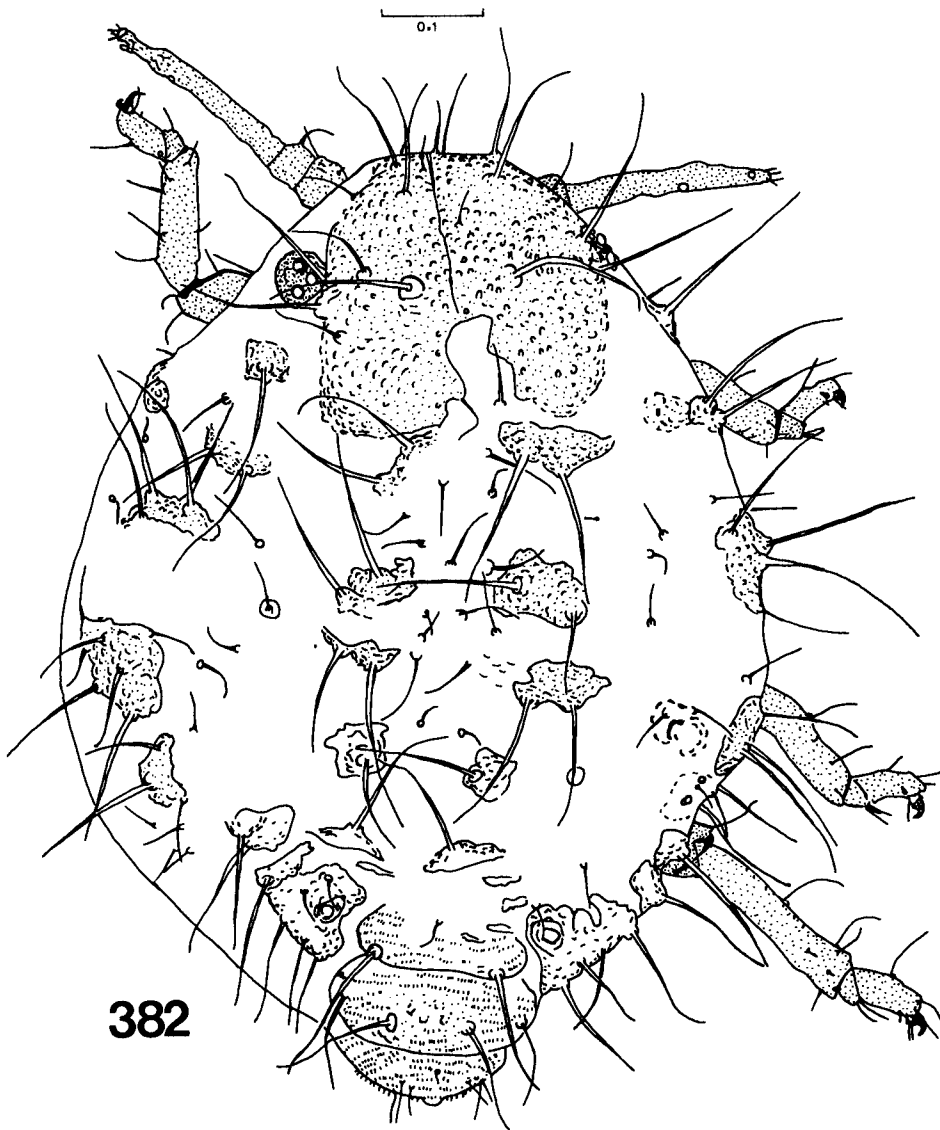

Fig. 382. *Nipponaphis multisetosa* spec. nov., presumably the second stage of the apterous viviparous ♀, dorsal side of the body.

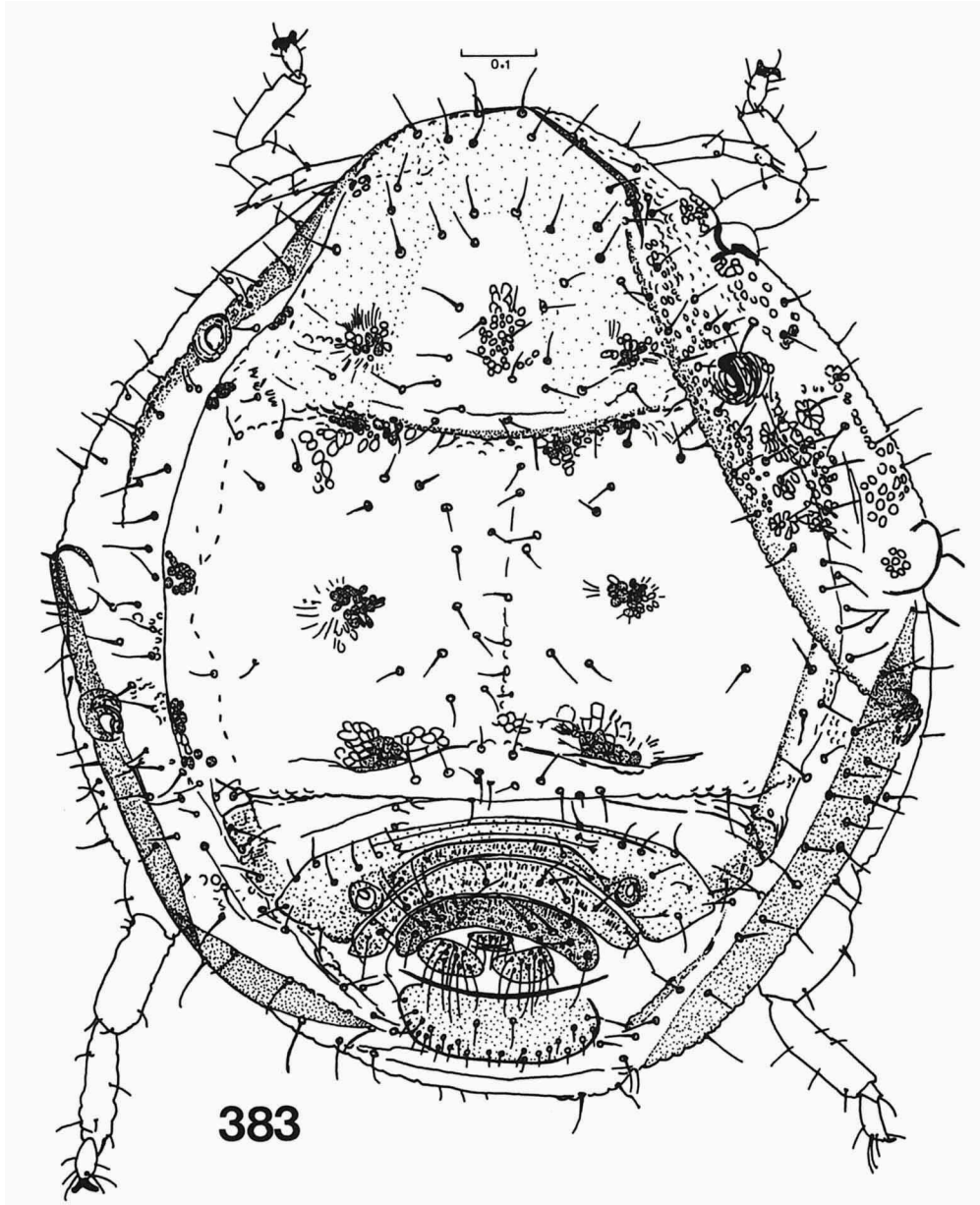

Fig. 383. *Nipponaphis semiglabra* spec. nov., apterous viviparous ♀, dorsal side of the body.

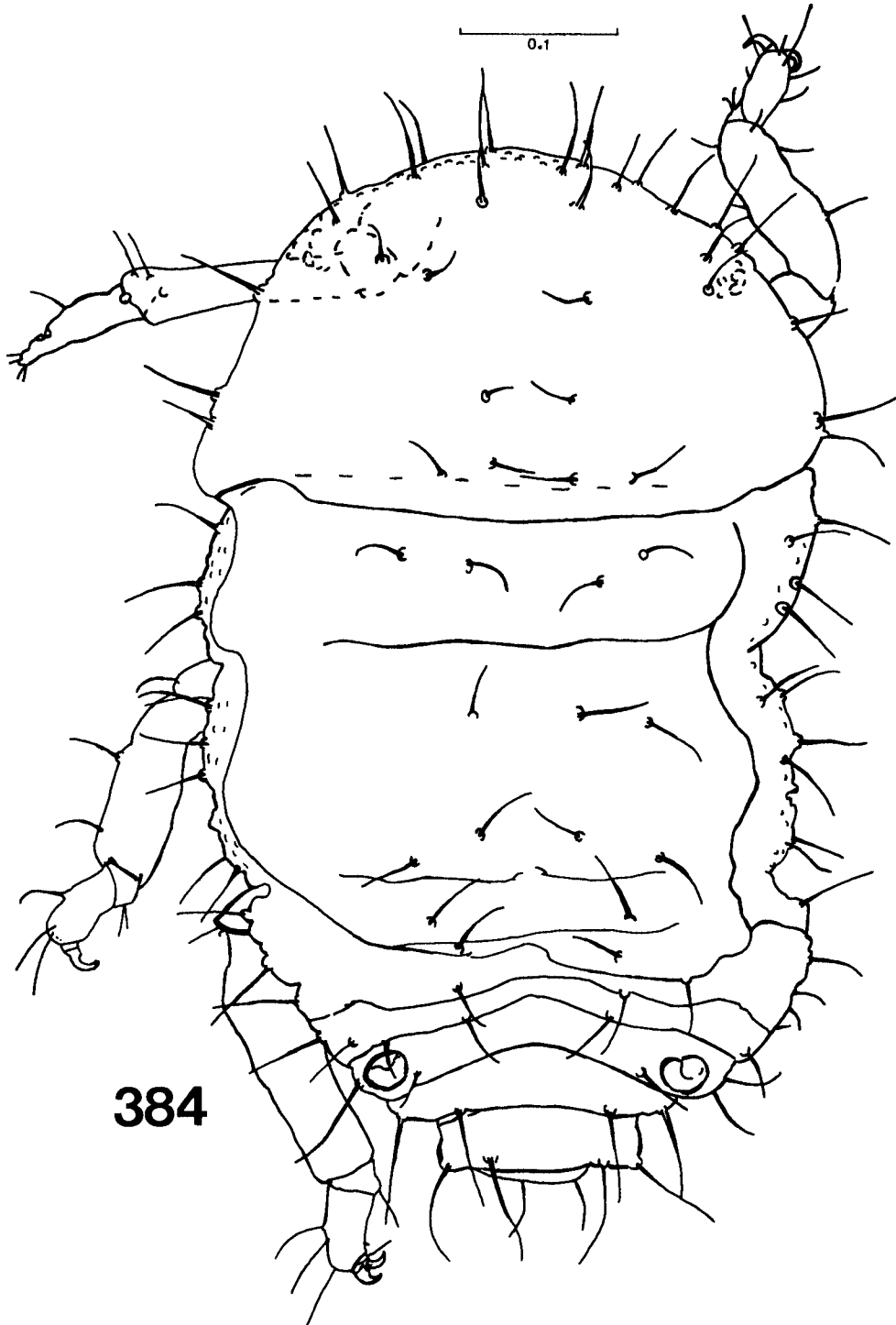
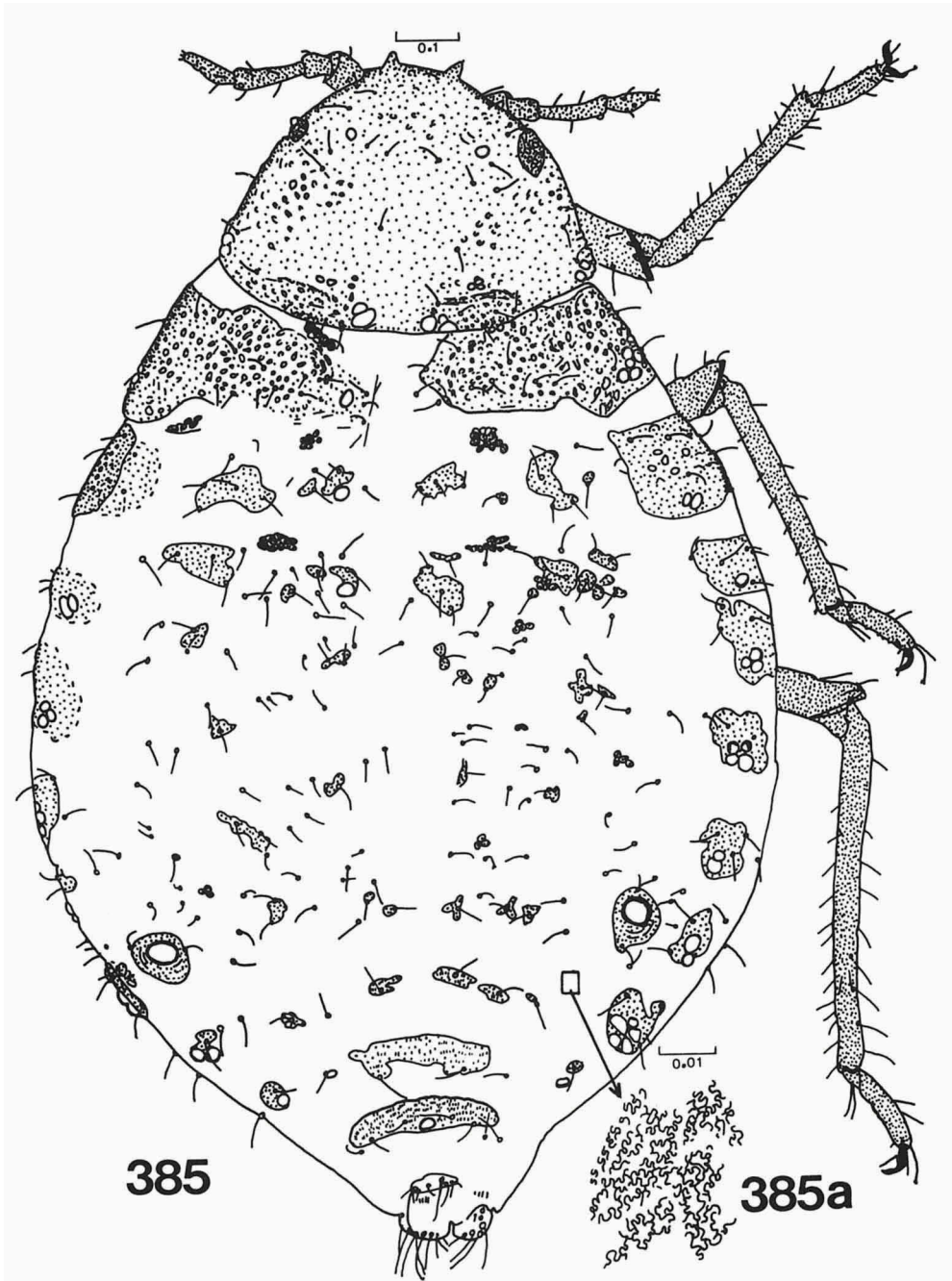
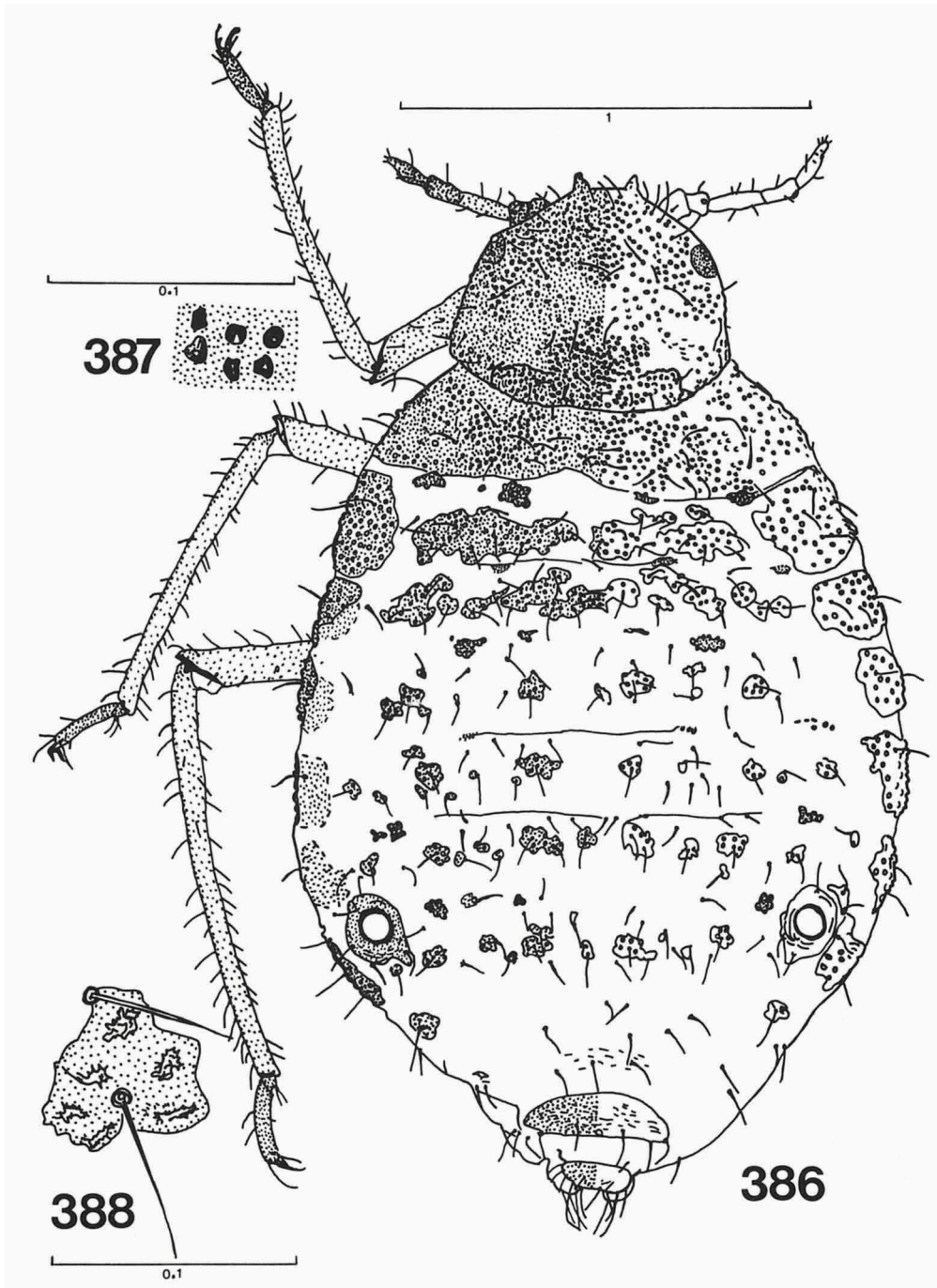

Fig. 384. *Nipponaphis semiglabra* spec. nov., presumably second stage larva of apterous viviparous ♀, dorsal side of the body.



Figs. 385-385a. *Pseudoregma bambusicola* (Takahashi), apterous viviparous ♀. Fig. 385, dorsal side of the body. Fig. 385a, s-shaped wax glands.



Figs. 386-388. *Pseudoregma bambusicola* (Takahashi), apterous viviparous ♀. Fig. 386, dorsal side of the body. Fig. 387, pustules on the pronotum. Fig. 388, sclerite dorsally on the abdomen with two hairs and star-shaped wax glands.

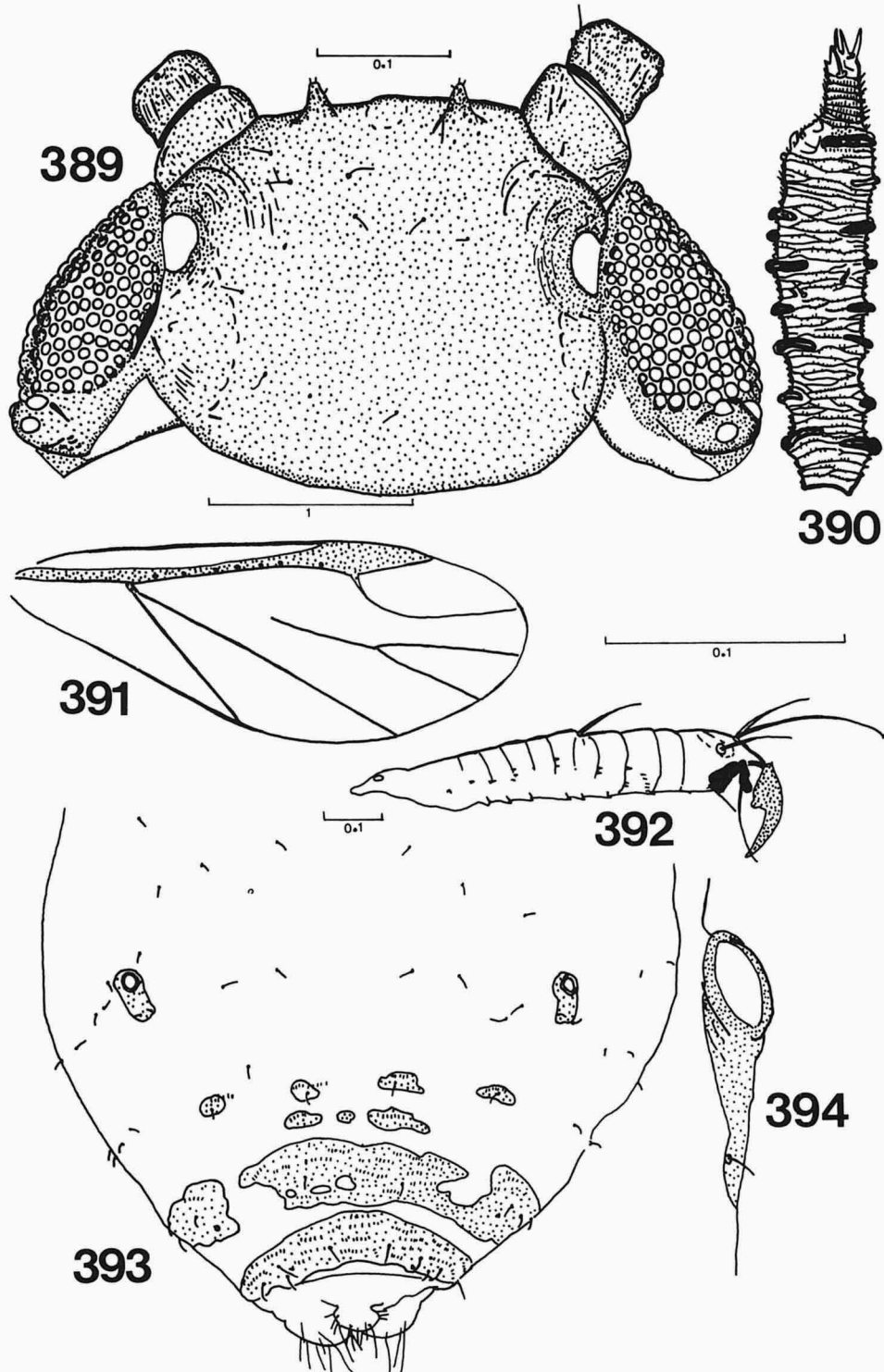

Figs. 389-394. *Pseudoregma bambusicola* (Takahashi), alate viviparous ♀. Fig. 389, dorsal side of the head. Fig. 390, dorsal side of antennal segment V. Fig. 391, fore wing. Fig. 392, second tarsal segment of the hind leg. Fig. 393, dorsal sides of abdominal segments IV-VIII. Fig. 394, siphunculus with sclerite at the posterior side.

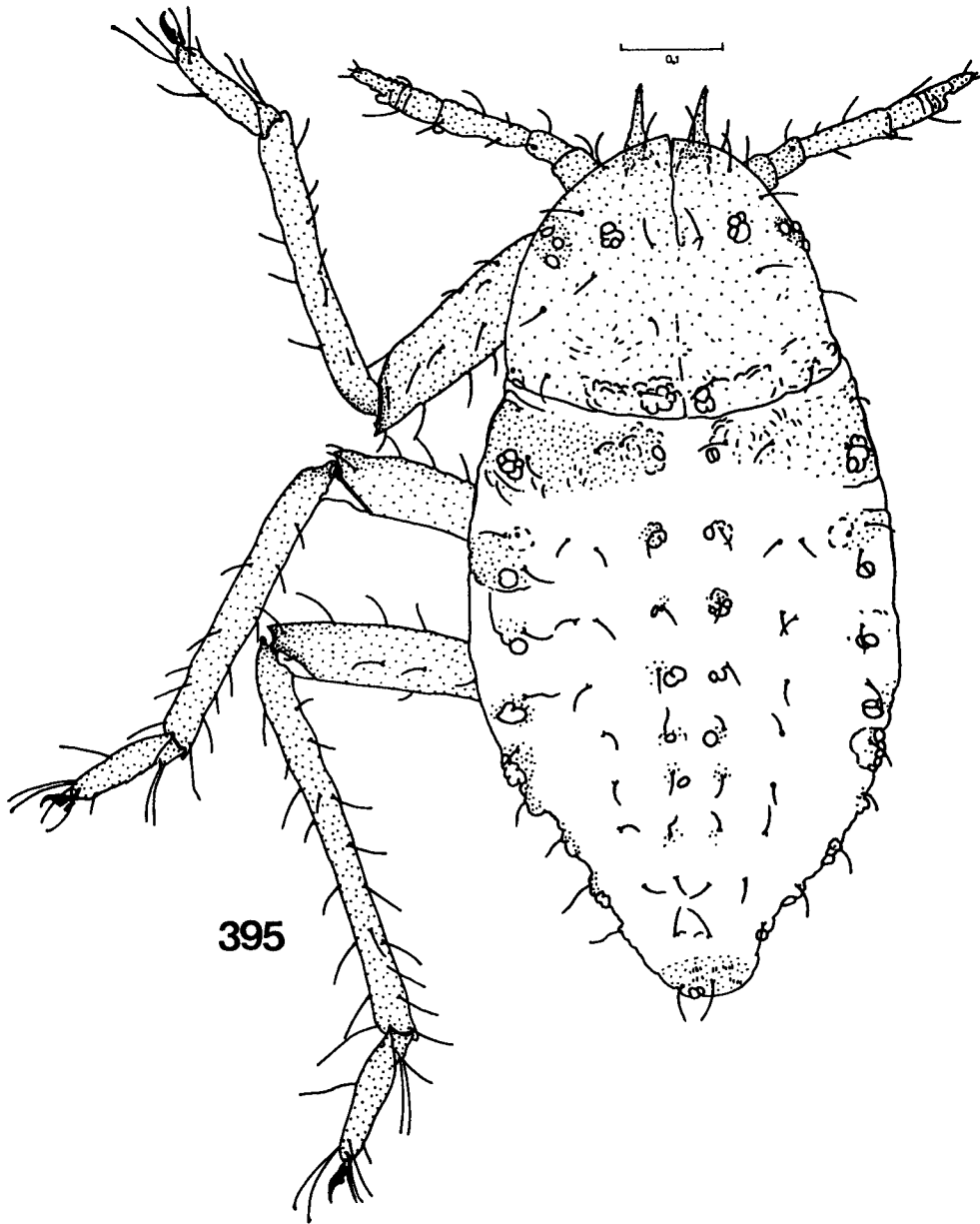

Fig. 395. *Pseudoregma bambusicola* (Takahashi), first stage larva, normal, dorsal side of the body.

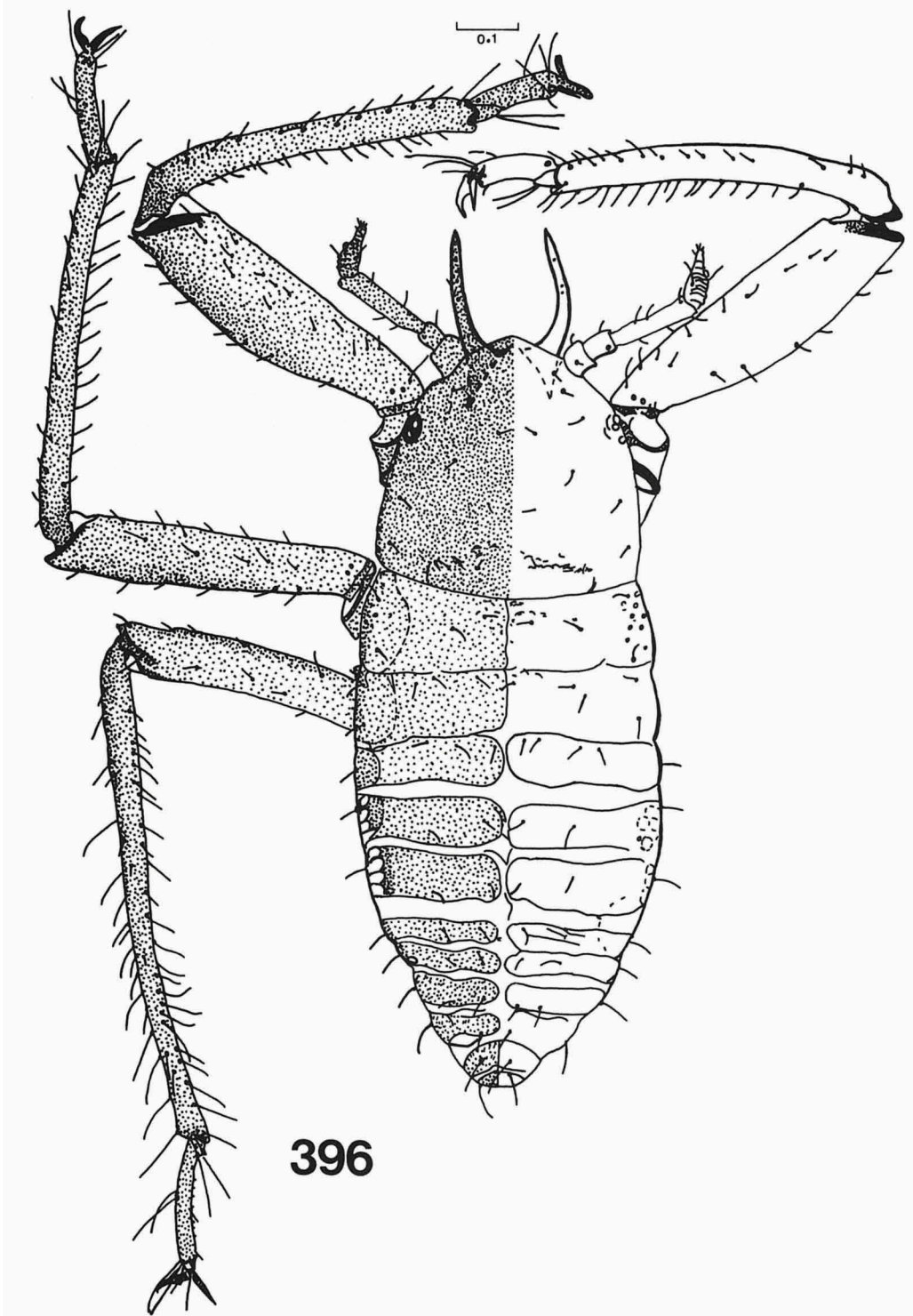

Fig. 396. *Pseudoregma bambusicola* (Takahashi), first stage larva, soldier, from apterous viviparous ♀, dorsal side of the body.



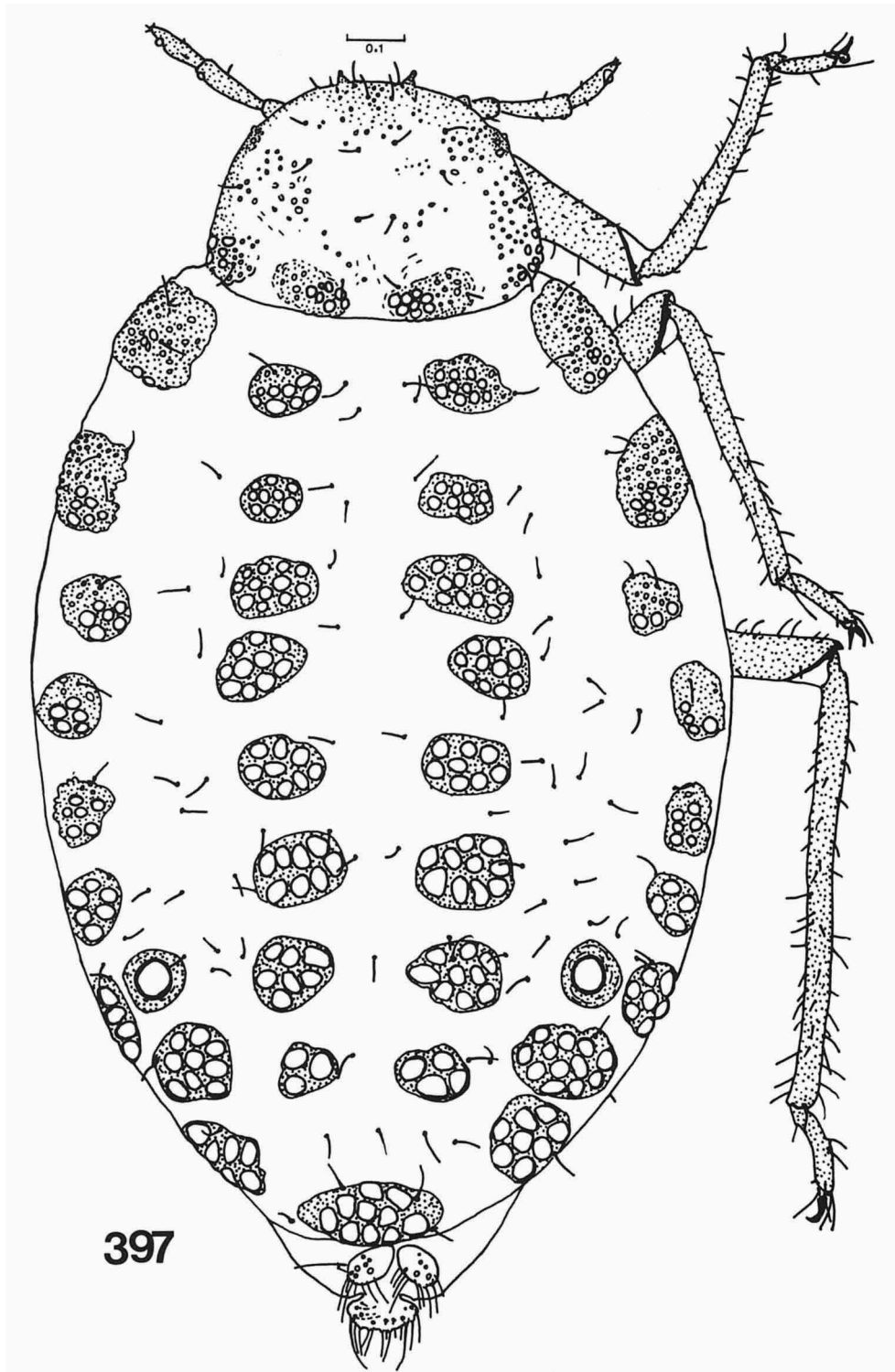
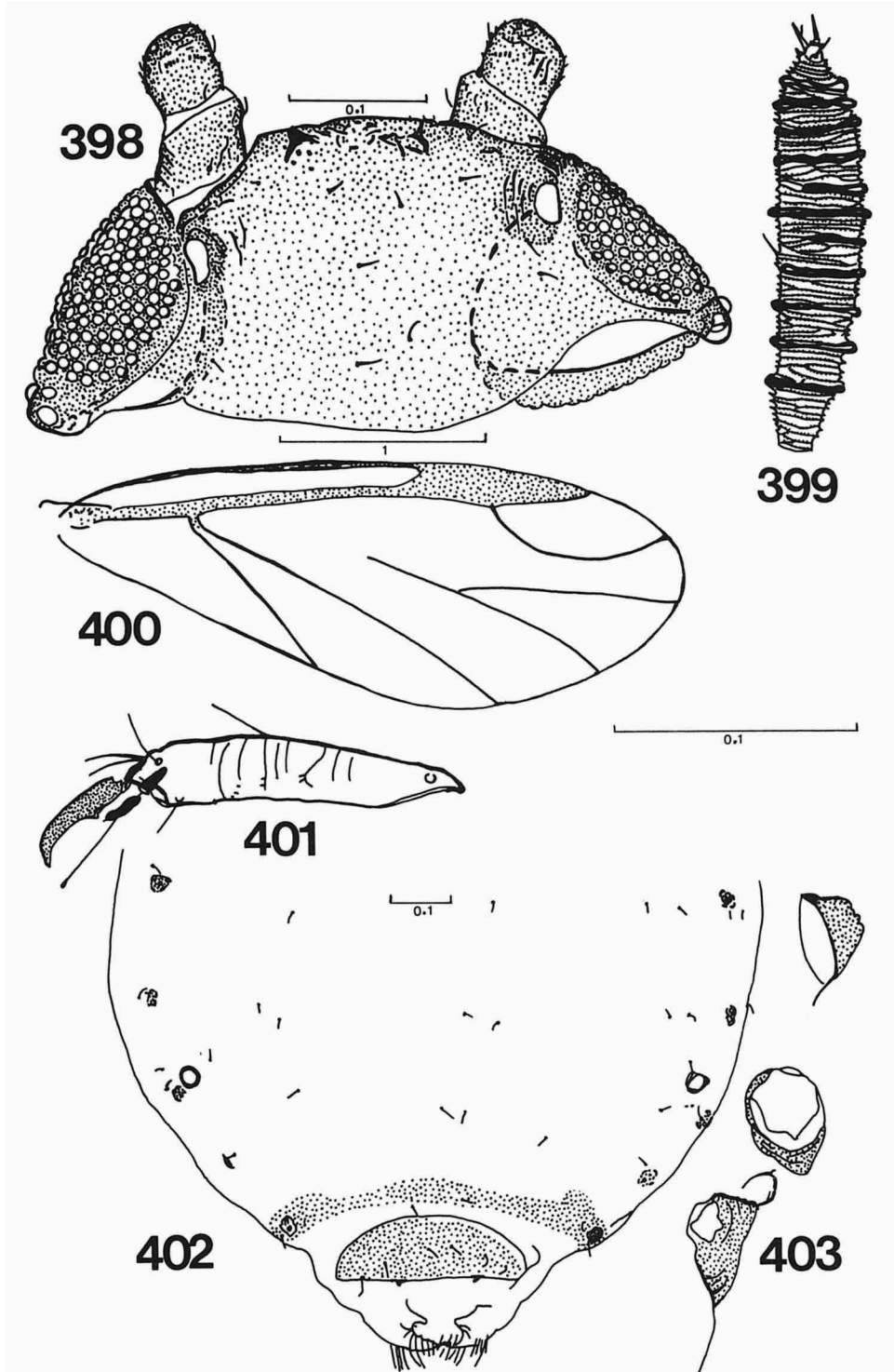

Fig. 397. *Pseudoregma montana* (Van der Goot), apterous viviparous ♀, dorsal side of the body.



Figs. 398-403. *Pseudoregma montana* (Van der Goot), alate viviparous ♀. Fig. 398, dorsal side of the head. Fig. 399, dorsal side of antennal segment V. Fig. 400, fore wing. Fig. 401, second tarsal segment of the hind leg. Fig. 402, dorsal sides of abdominal segments III-VIII. Fig. 403, three separate siphunculi.

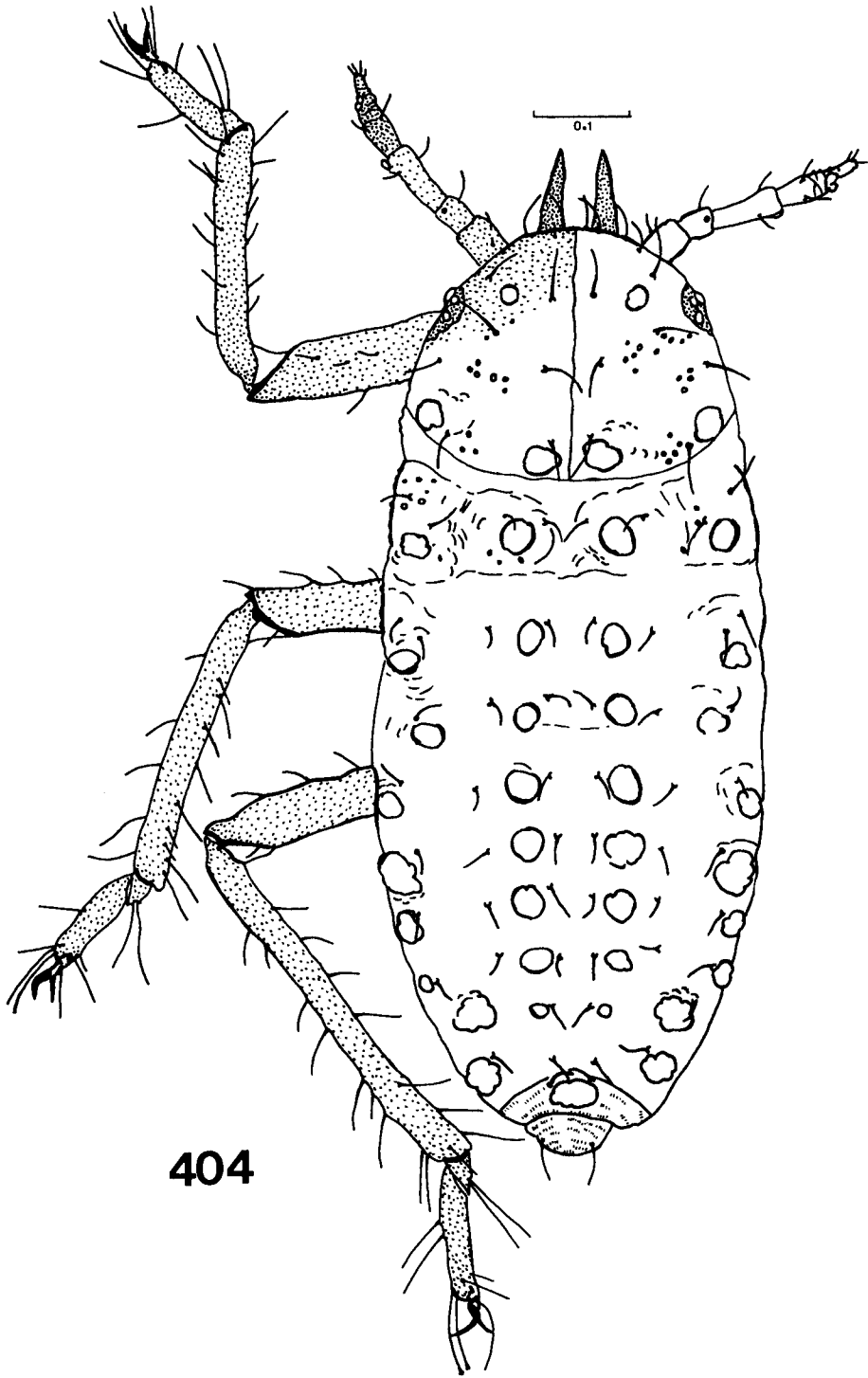

Fig. 404. *Pseudoregma montana* (Van der Goot), first stage larva, normal, dorsal side of the body.

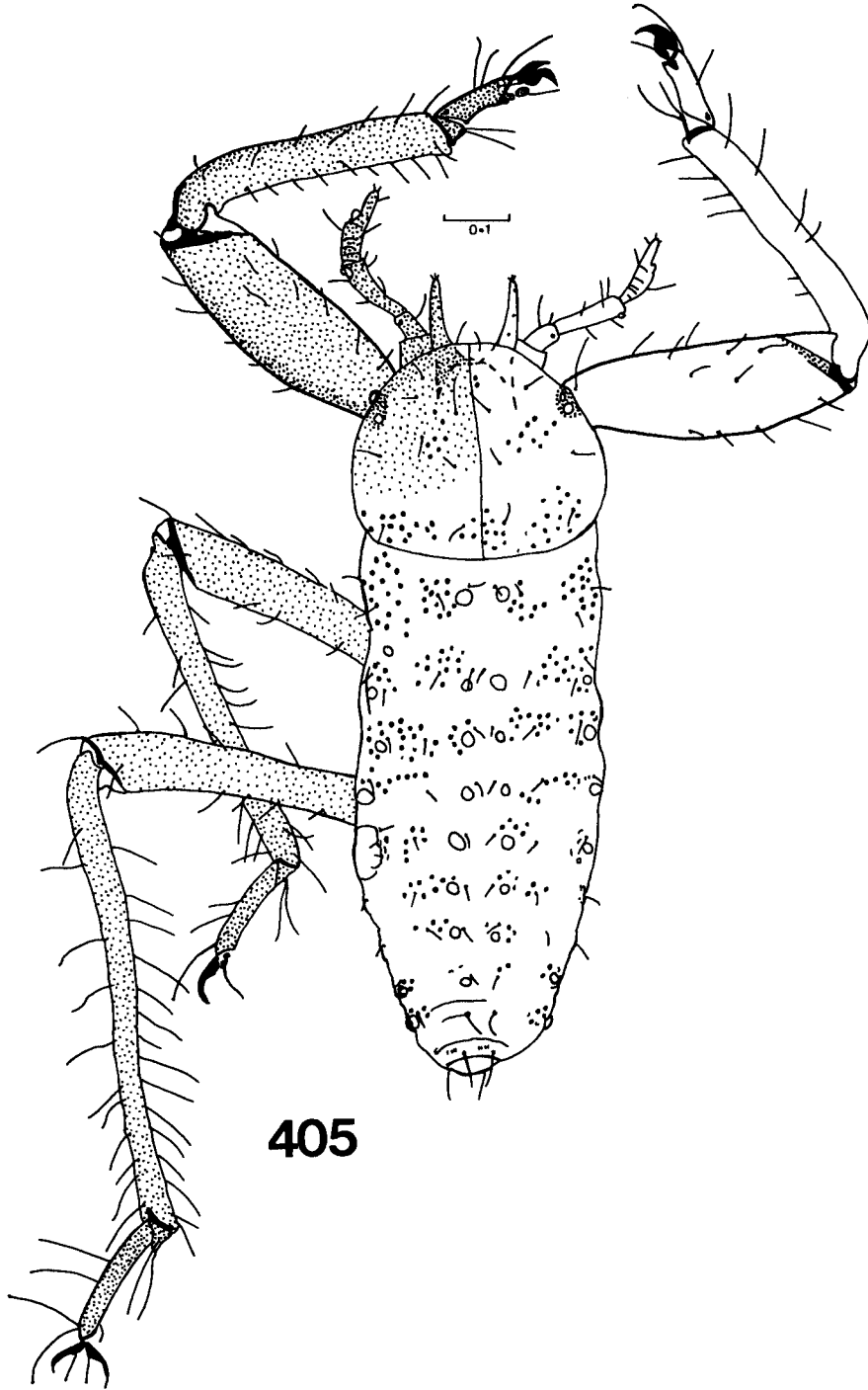
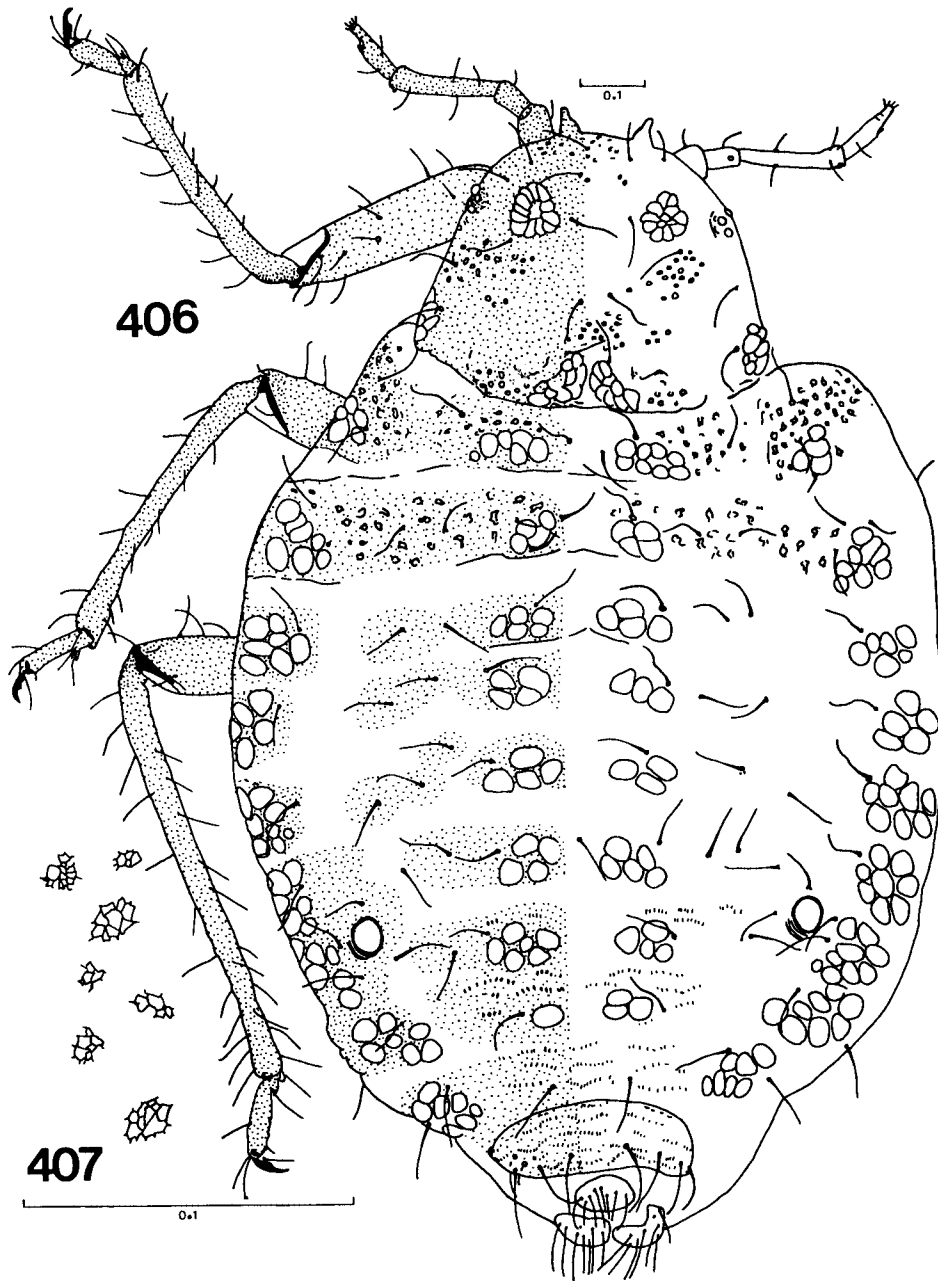

Fig. 405. *Pseudoregma montana* (Van der Goot), first stage larva, soldier, dorsal side of the body.



Figs. 406-407. *Pseudoregma nicolaiiae* (Takahashi), apterous viviparous ♀. Fig. 406, dorsal side of the body. Fig. 407, star-shaped wax glands dorsally on the abdomen.

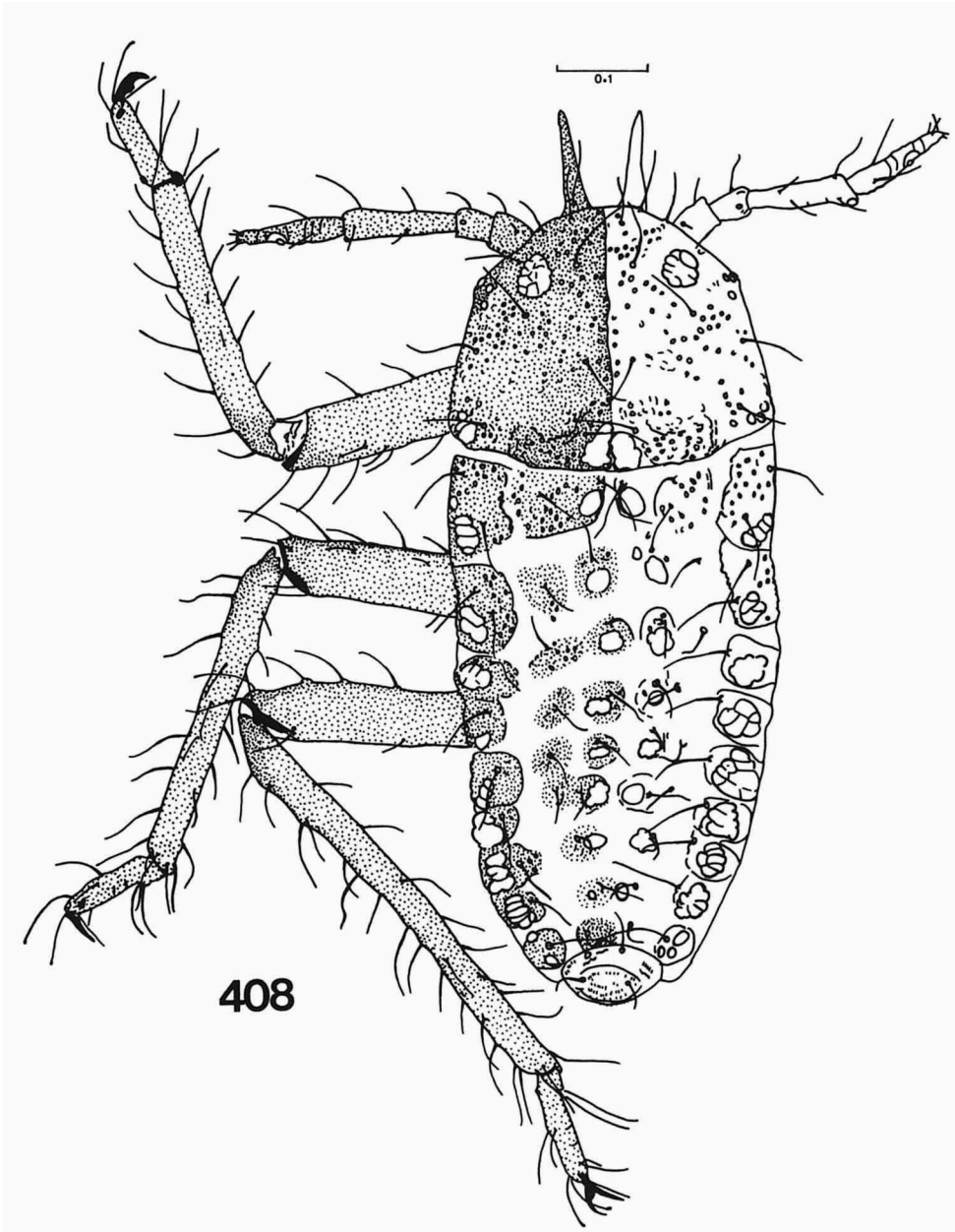
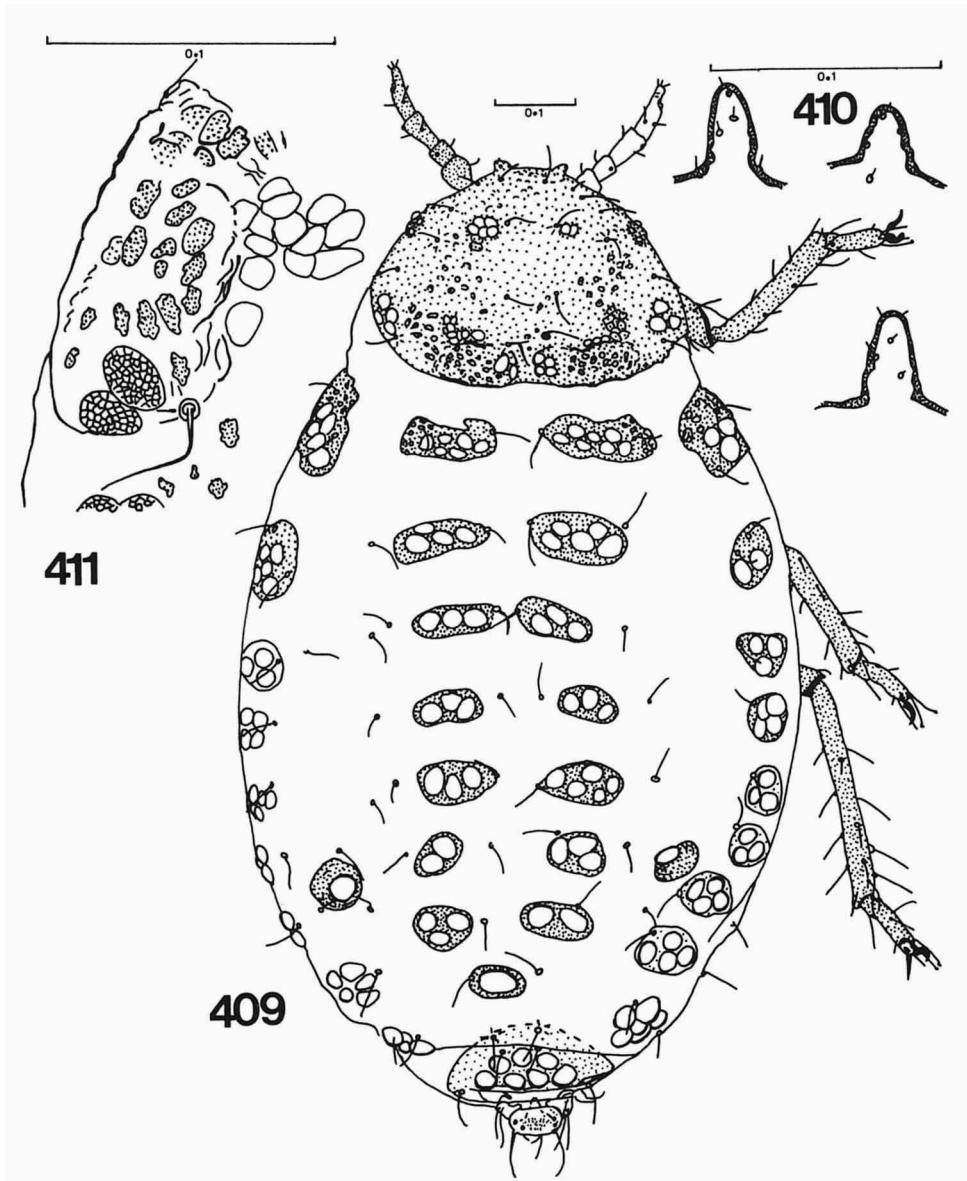
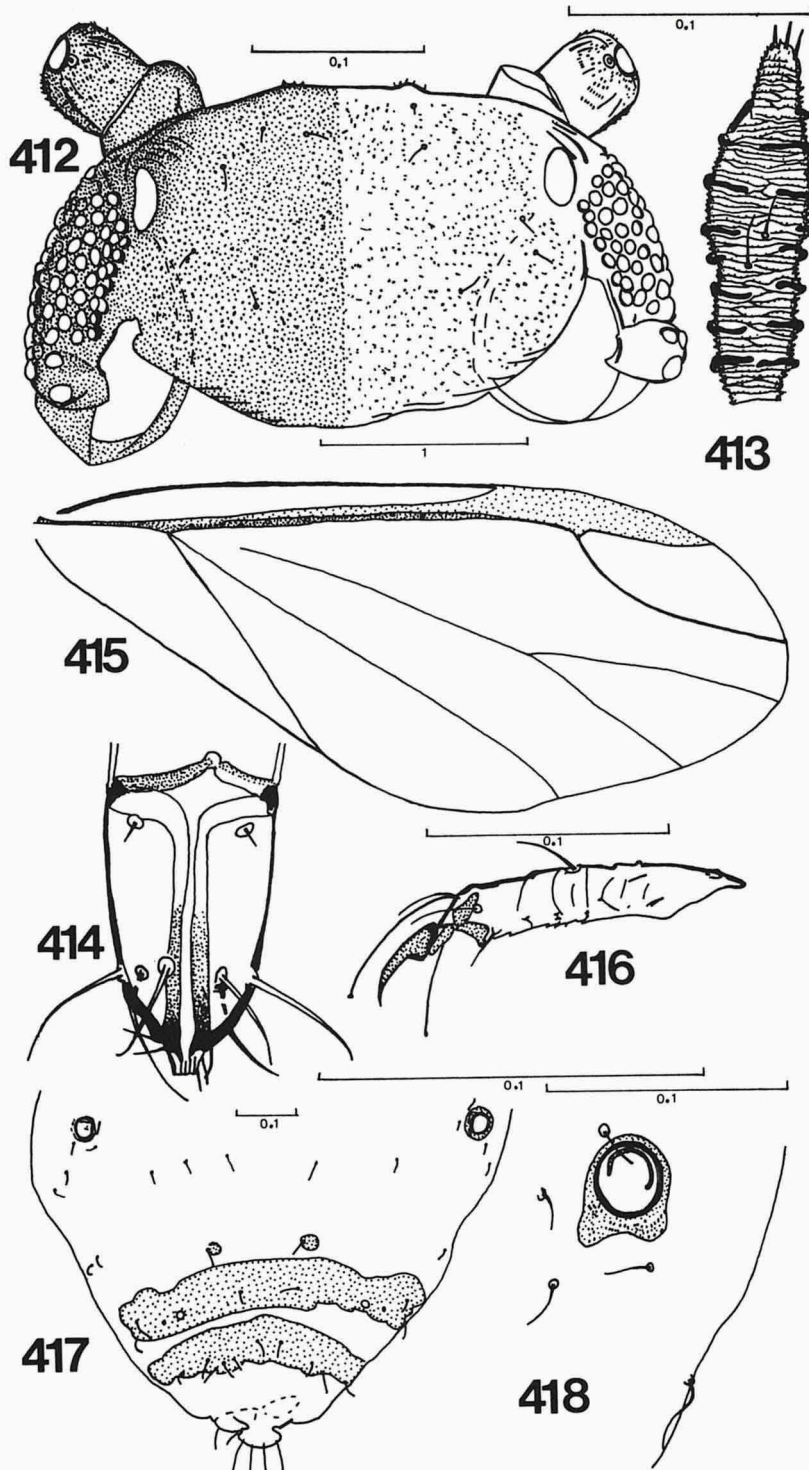

Fig. 408. *Pseudoregma nicolaiiae* (Takahashi), first stage larva, normal, dorsal side of the body.



Figs. 409-411. *Pseudoregma panicola* (Takahashi), apterous viviparous ♀. Fig. 409, dorsal side of the body. Fig. 410, three horns of different specimens. Fig. 411, margin of the prothorax with pustules, two wax glands, and to the medial side a muscular plate.



Figs. 412-418. *Pseudoregma panicola* (Takahashi), alate viviparous ♀. Fig. 412, dorsal side of the head. Fig. 413, dorsal side of antennal segment V. Fig. 414, ultimate rostral segment. Fig. 415, fore wing. Fig. 416, second tarsal segment of the hind leg. Fig. 417, dorsal sides of abdominal segments V-VIII. Fig. 418, siphunculus. The longest 0.1 line to fig. 414 only.



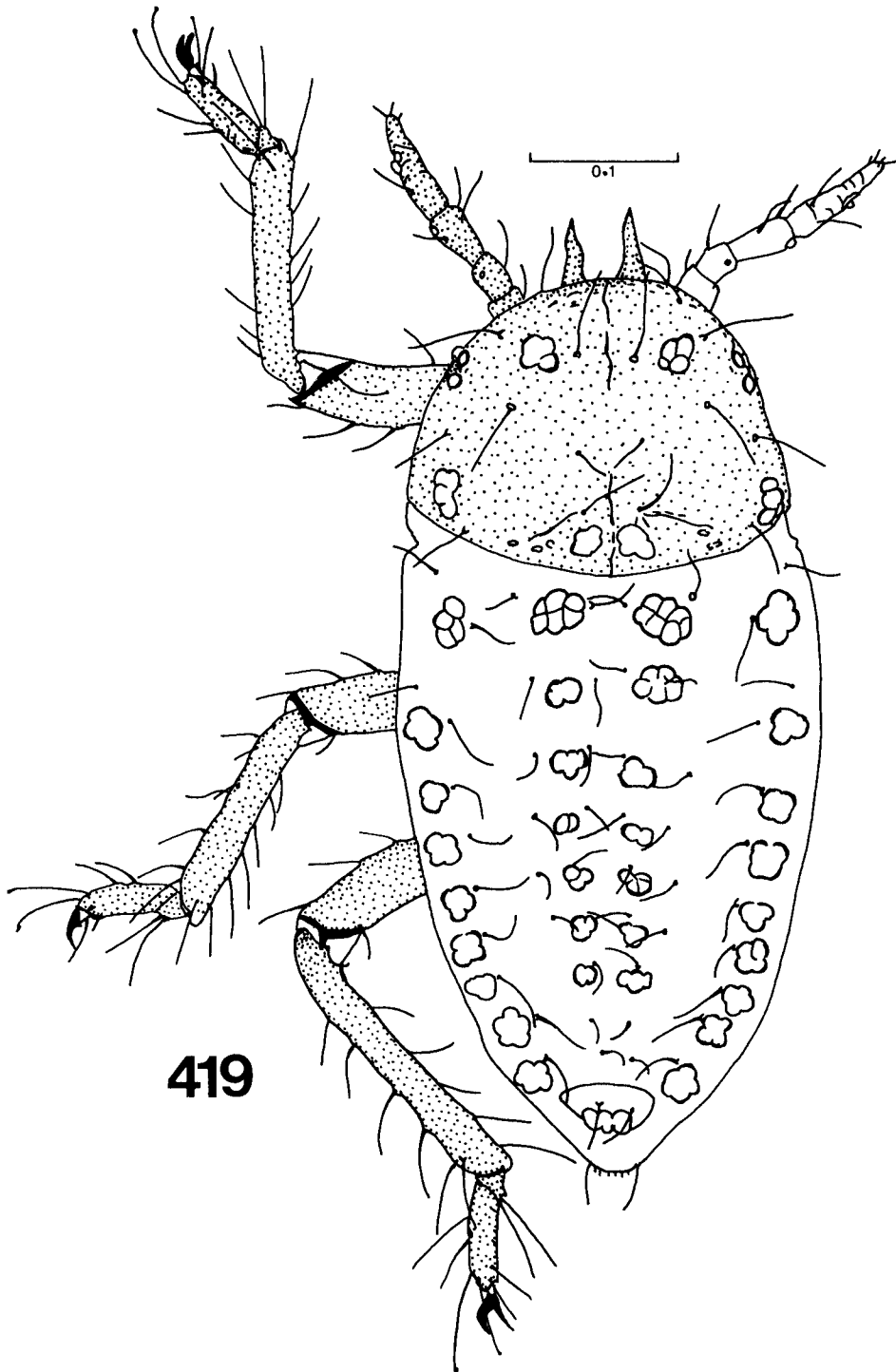

Fig. 419. *Pseudoregma panicola* (Takahashi), first stage larva, normal, dorsal side of the body.

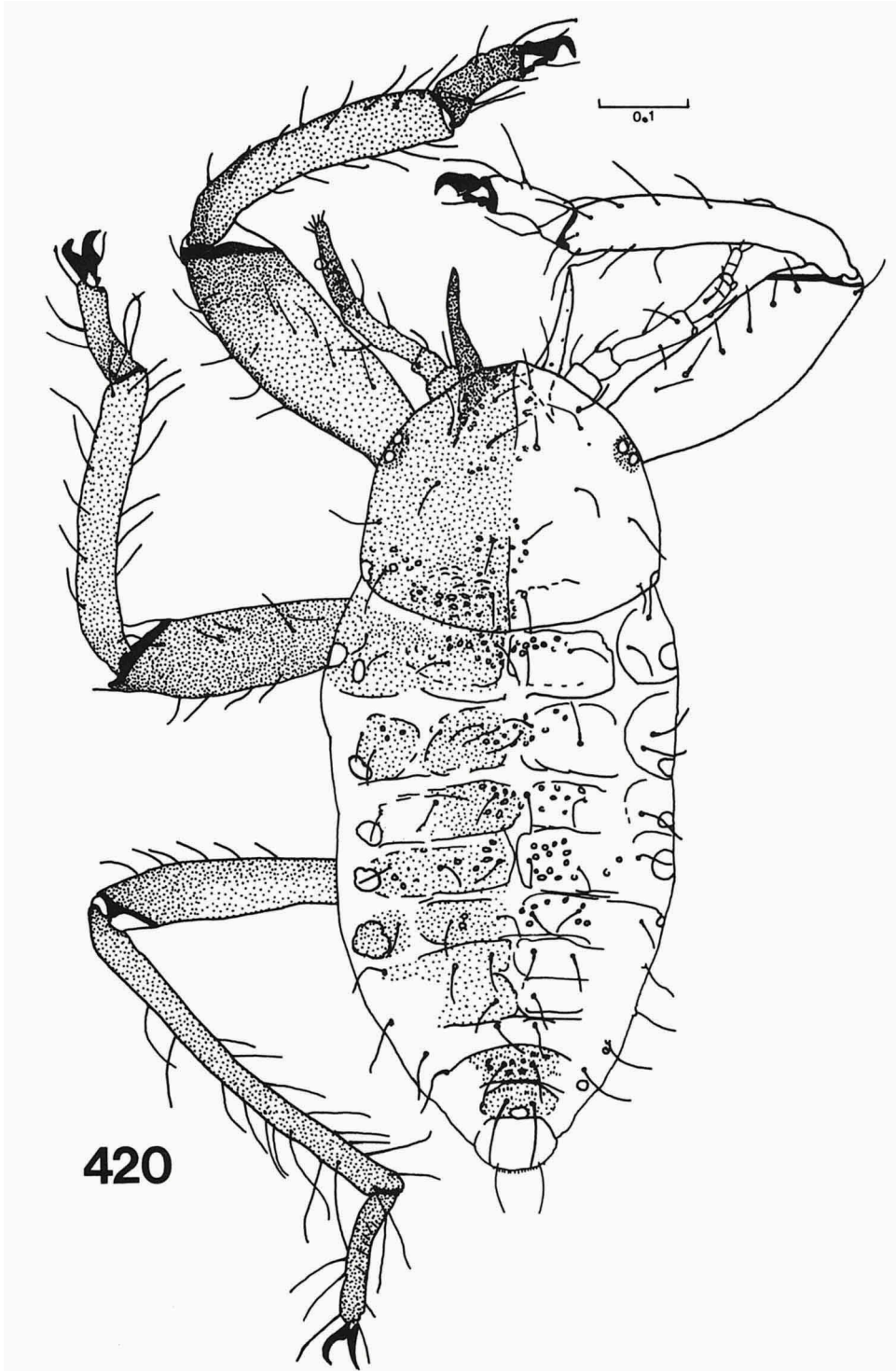

Fig. 420. *Pseudoregma panicola* (Takahashi), first stage larva, soldier, dorsal side of the body.

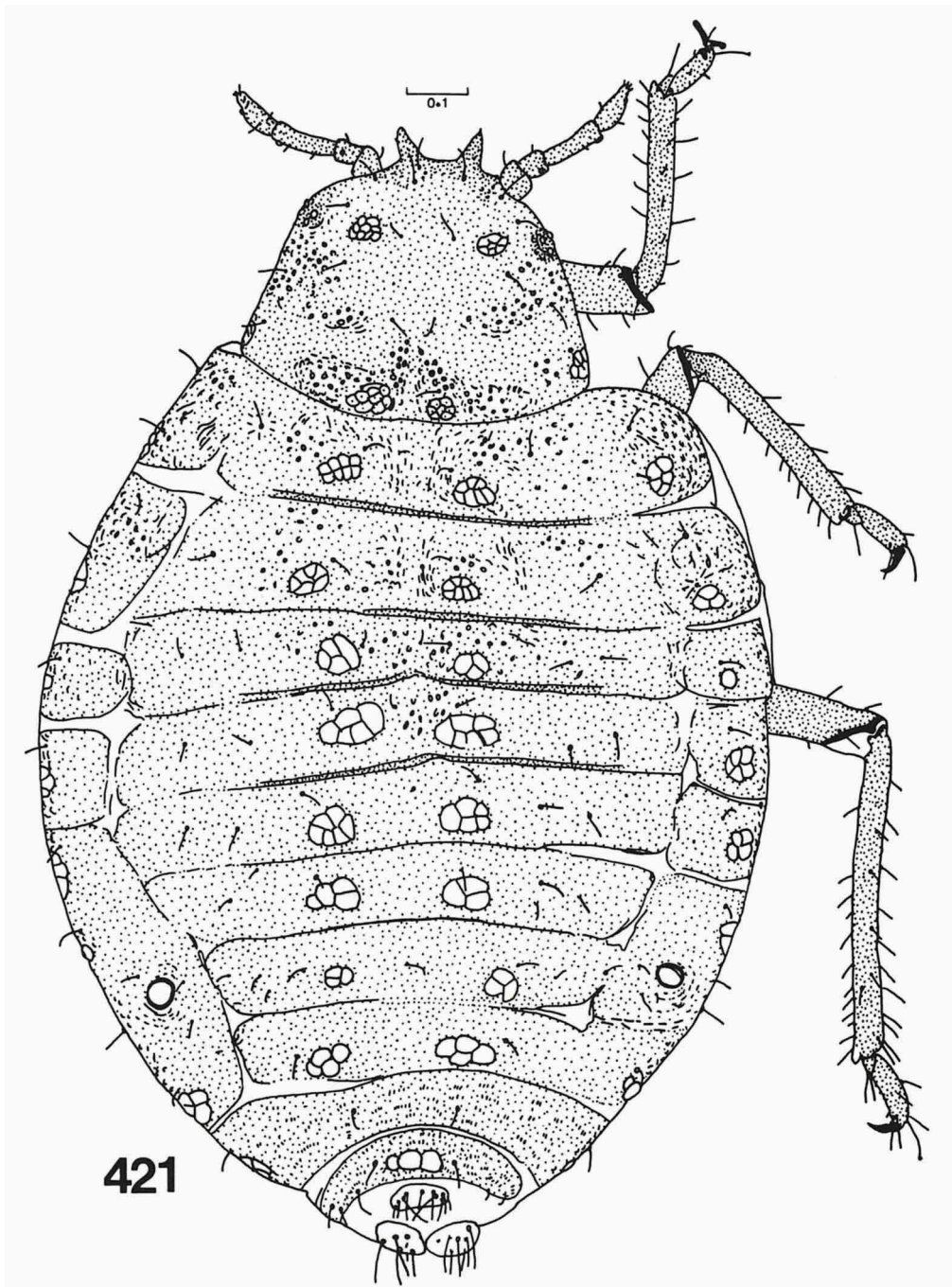

Fig. 421. *Pseudoregma pendleburyi* (Takahashi), apterous viviparous ♀, dorsal side of the body.

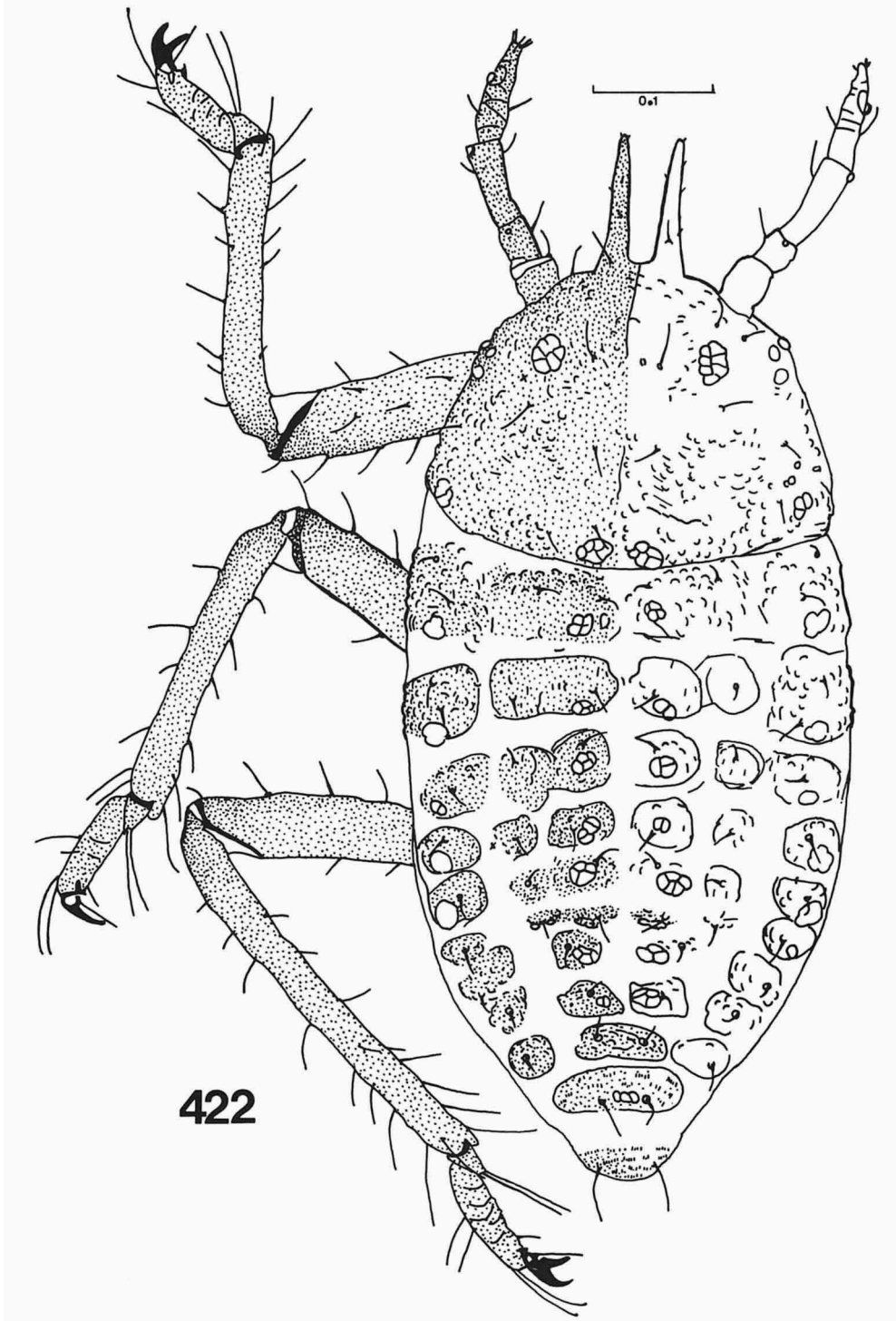

Fig. 422. *Pseudoregma pendleburyi* (Takahashi), first stage larva, normal, dorsal side of the body.

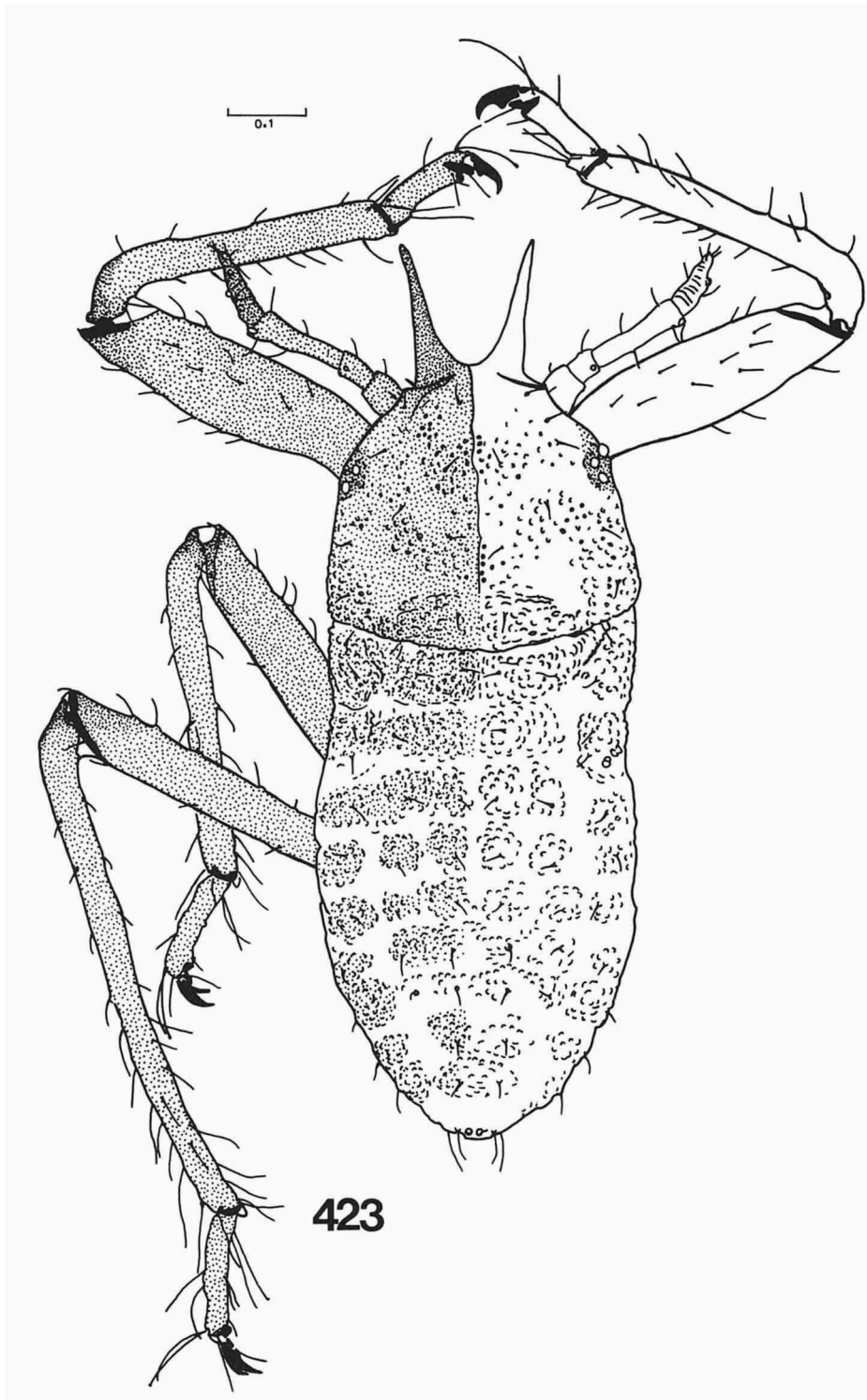

Fig. 423. *Pseudoregma pendleburyi* (Takahashi), first stage larva, soldier, dorsal side of the body.

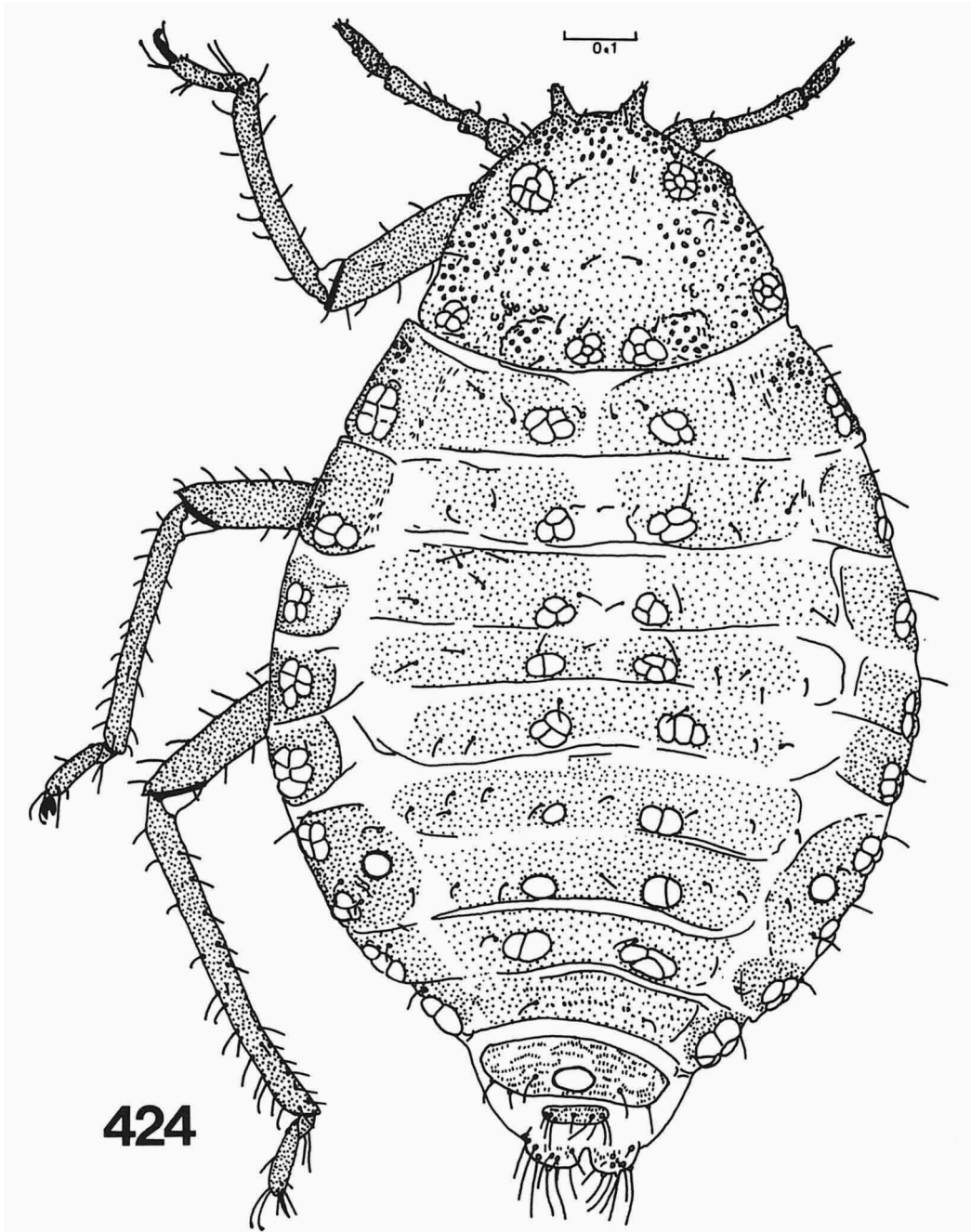
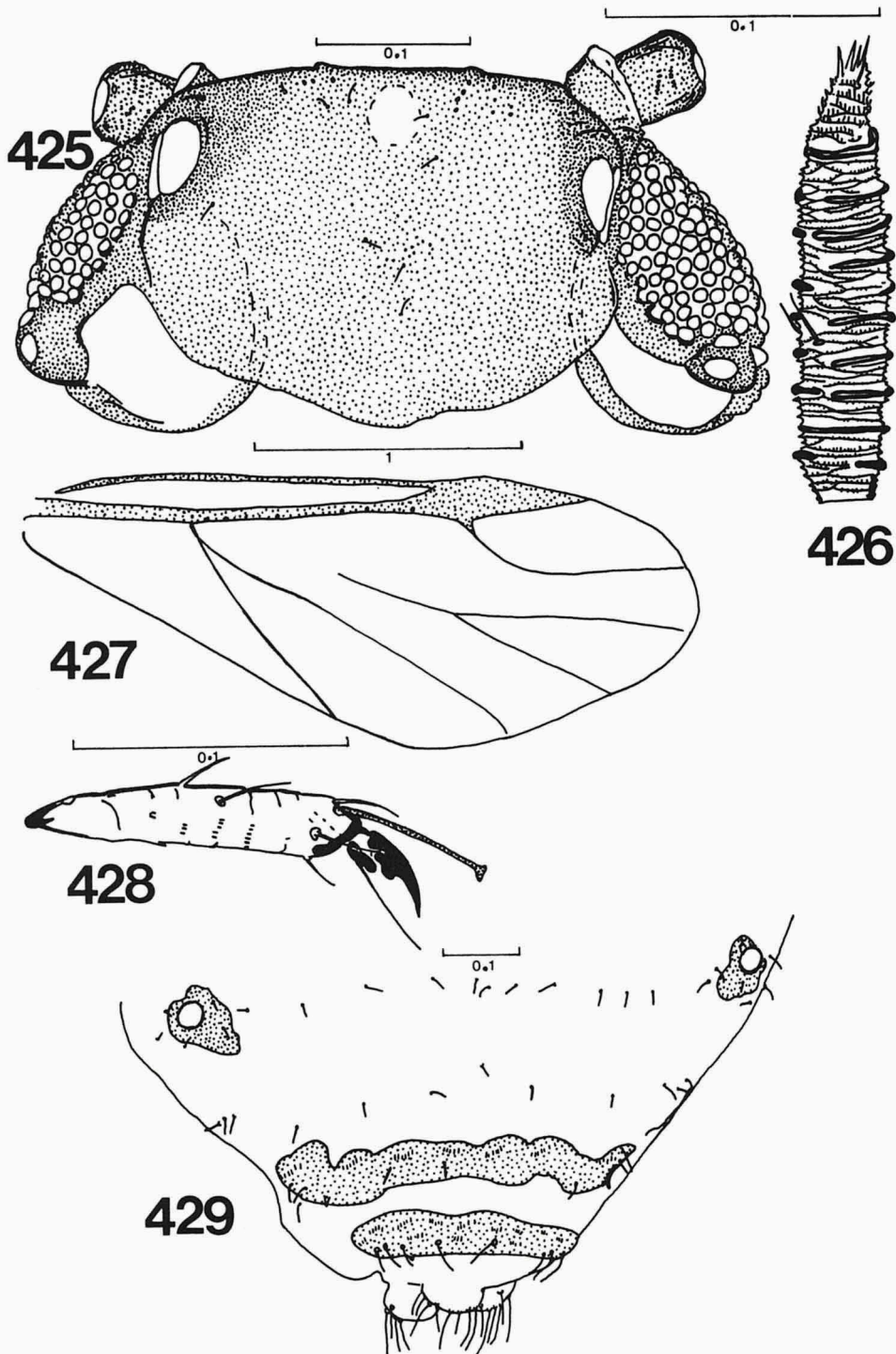

Fig. 424. *Pseudoregma sundanica* (Van der Goot), apterous viviparous ♀, dorsal side of the body.



Figs. 425-429. *Pseudoregma sundanica* (Van der Goot), alate viviparous ♀. Fig. 425, dorsal side of the head. Fig. 426, dorsal side of antennal segment V. Fig. 427, fore wing. Fig. 428, second tarsal segment of the hind leg. Fig. 429, dorsal sides of abdominal segments V-VIII.

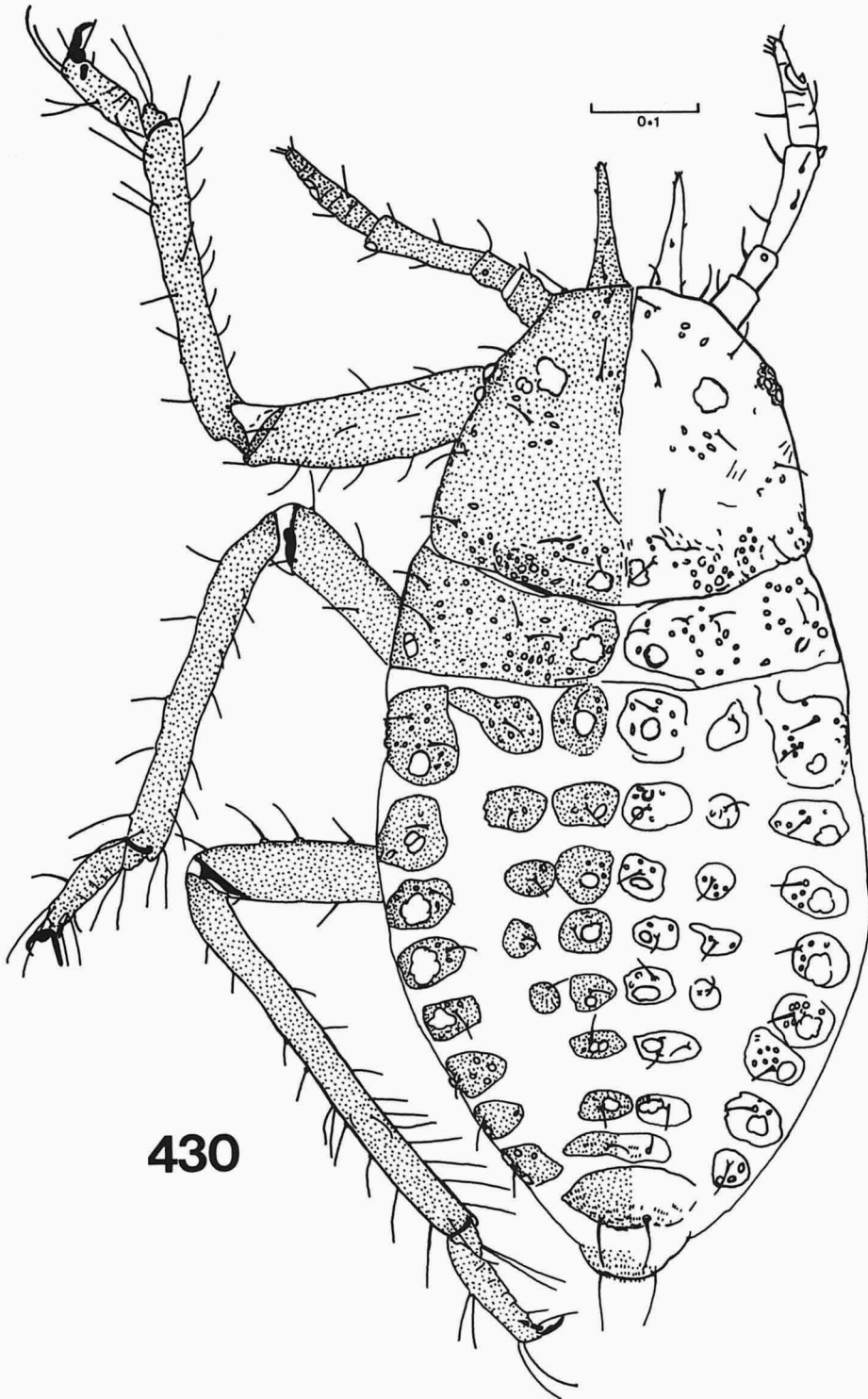

Fig. 430. *Pseudoregma sundanica* (Van der Goot), first stage larva, normal, dorsal side of the body.



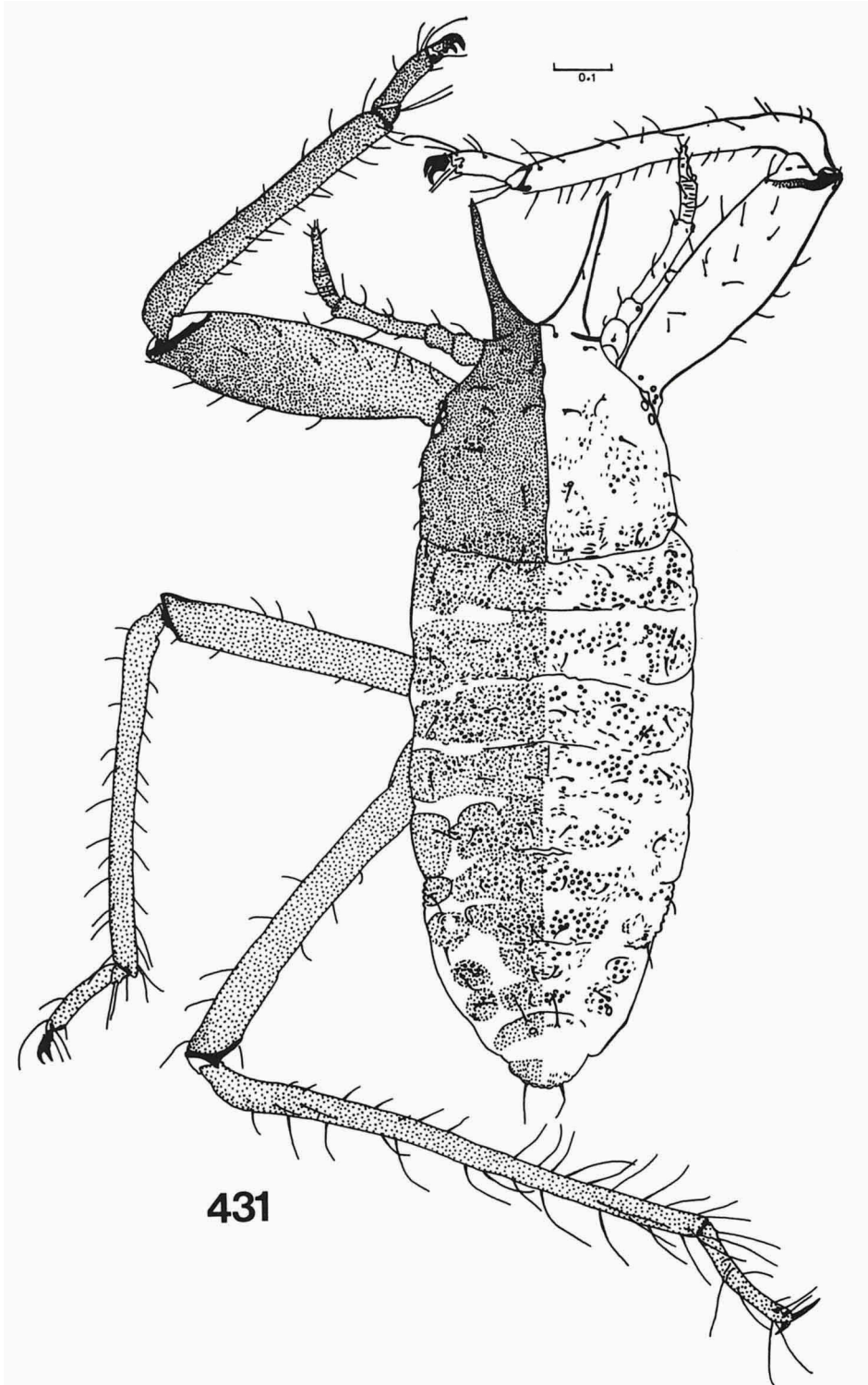

Fig. 431. *Pseudoregma sundanica* (Van der Goot), first stage larva, soldier, dorsal side of the body.

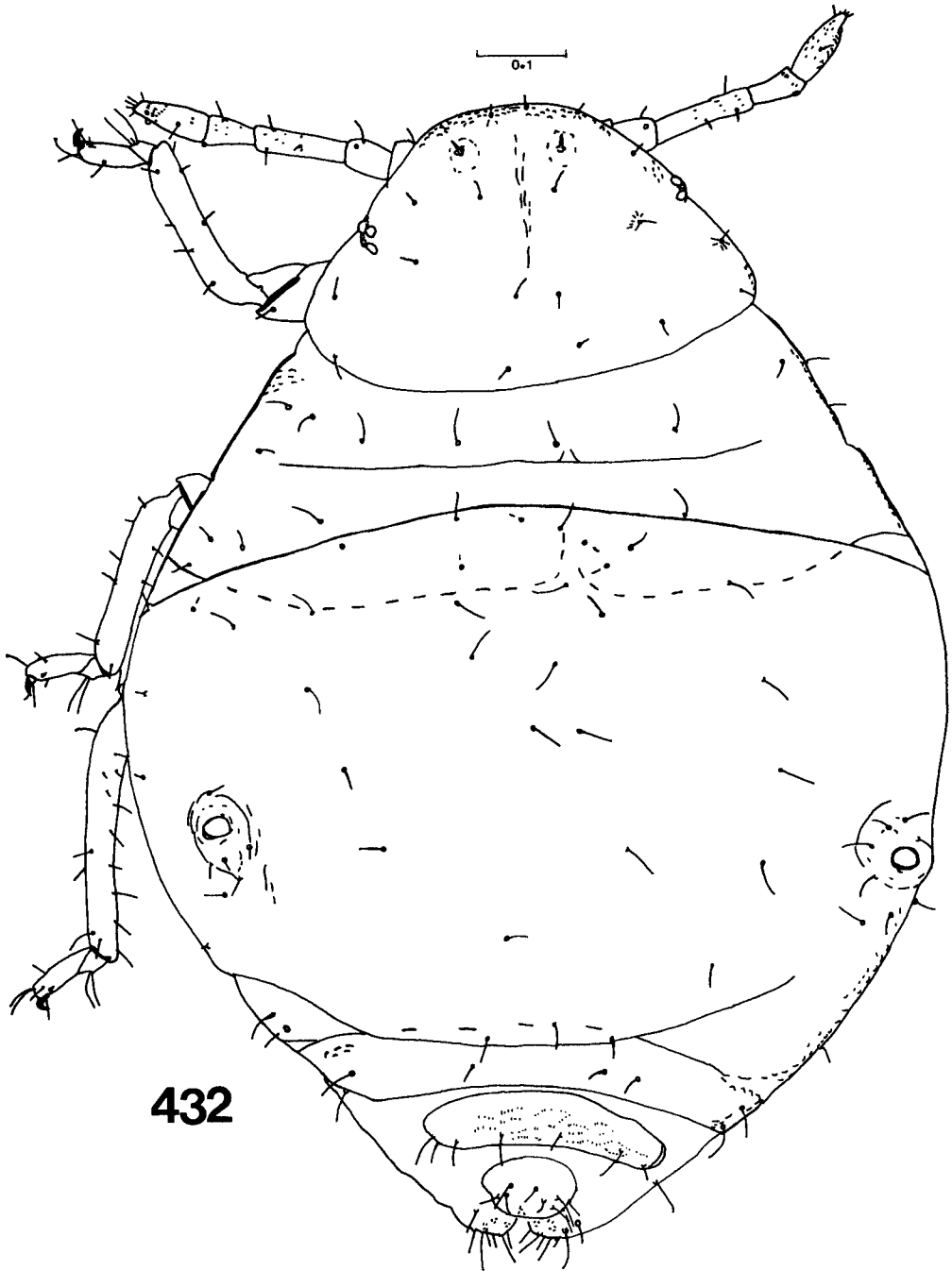
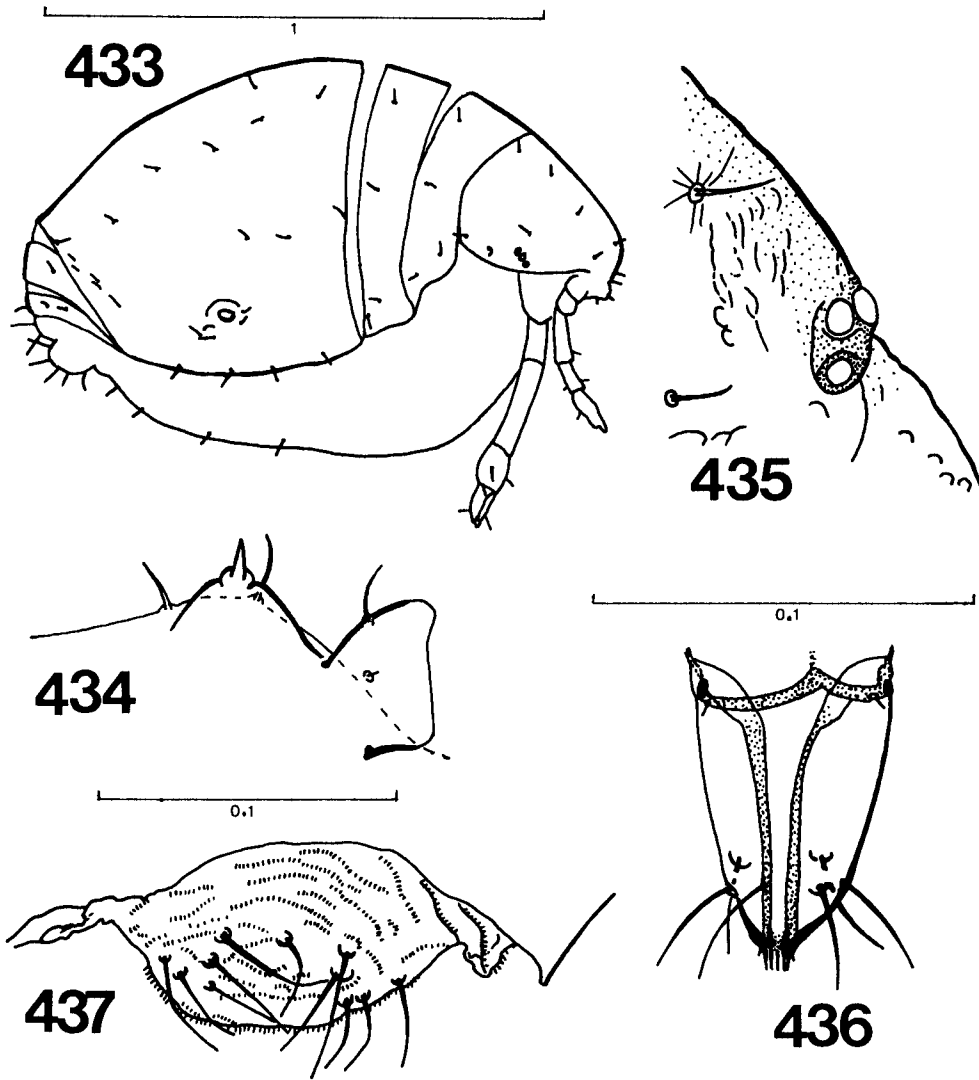
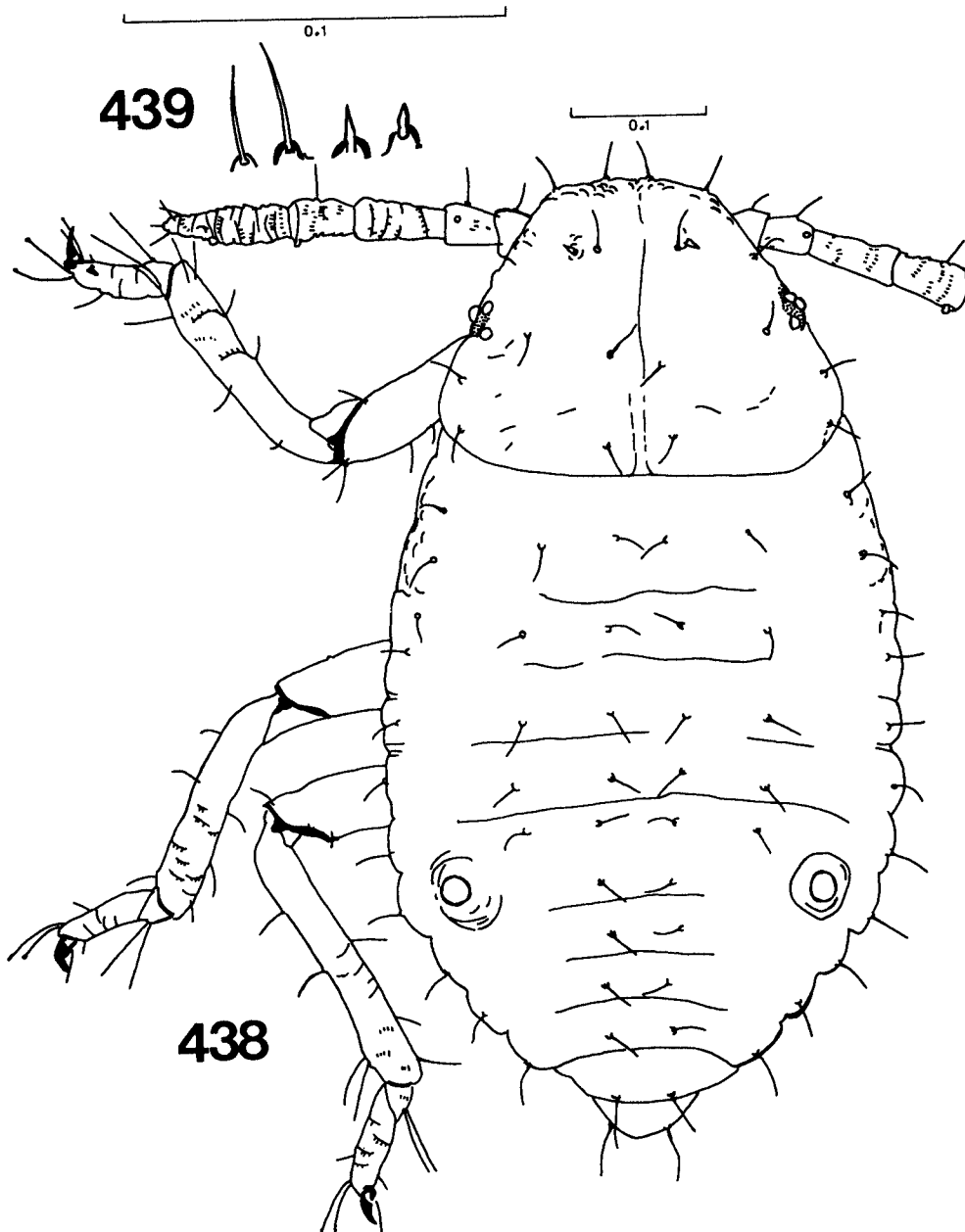

Fig. 432. *Rappardiella cerina* spec. nov., apterous viviparous ♀, dorsal side of the body.



Figs. 433-437. *Rappardiella cerina* spec. nov., apterous viviparous ♀. Fig. 433, body seen from the side. Fig. 434, horn and first antennal segment, ventrally. Fig. 435, eye. Fig. 436, ultimate rostral segment. Fig. 437, cauda. Scale line 0.1 left to figs. 434, 435, and 437; scale line above fig. 436 belonging to that fig.



Figs. 438-439. *Rappardiella cerina* spec. nov., first stage larva. Fig. 438, dorsal side of the body. Fig. 439, two normal frontal hairs (left), and two ventral sturdy hairs (right).

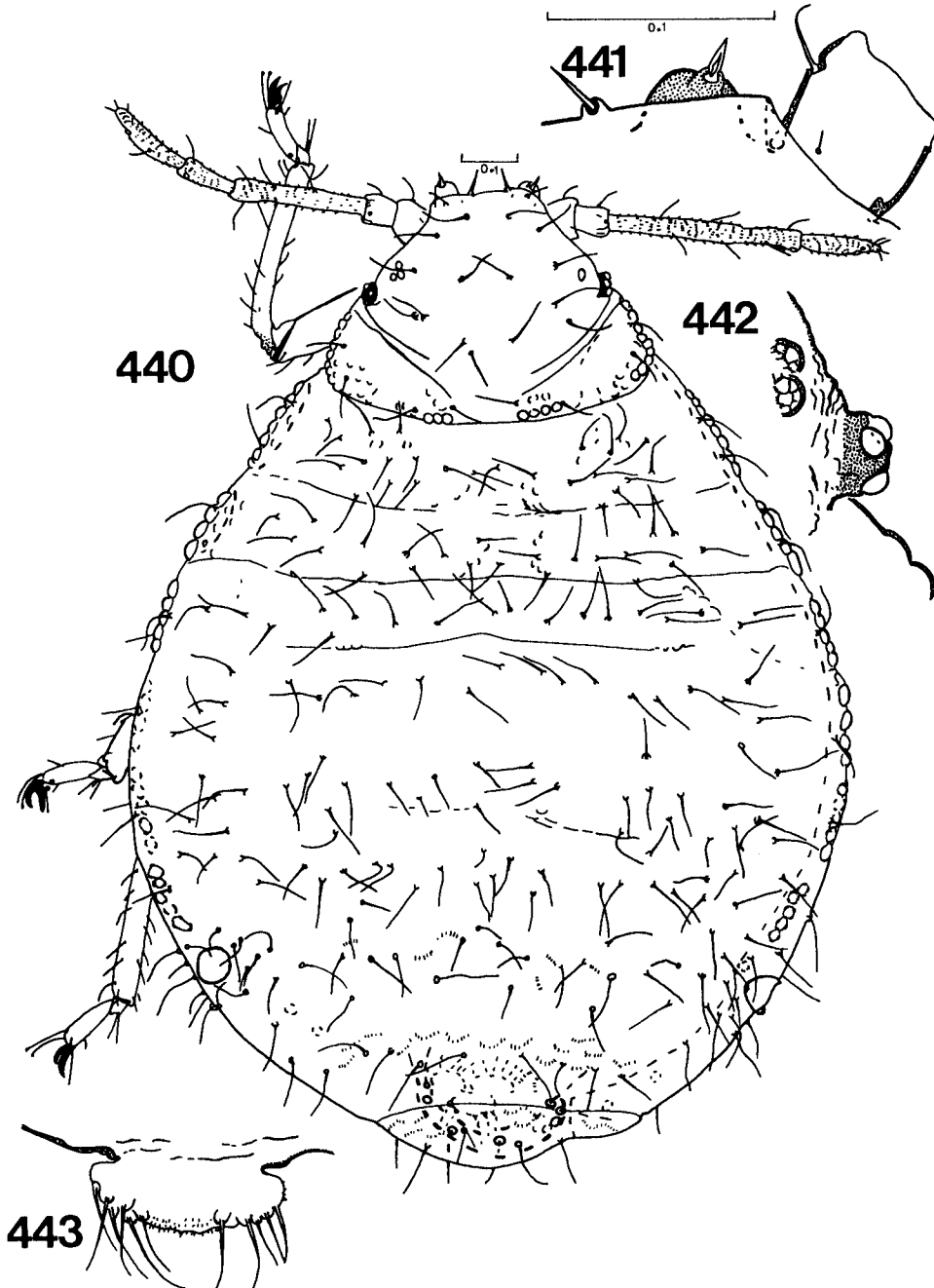

Figs. 440-443. *Rappardiella loranthi* (Van der Goot), apterous viviparous ♀. Fig. 440, dorsal side of the body. Fig. 441, horn, first antennal segment and median frontal hair. Fig. 442, eye and two wax glands. Fig. 443, cauda. Longest 0.1 scale line to figs. 441-443.

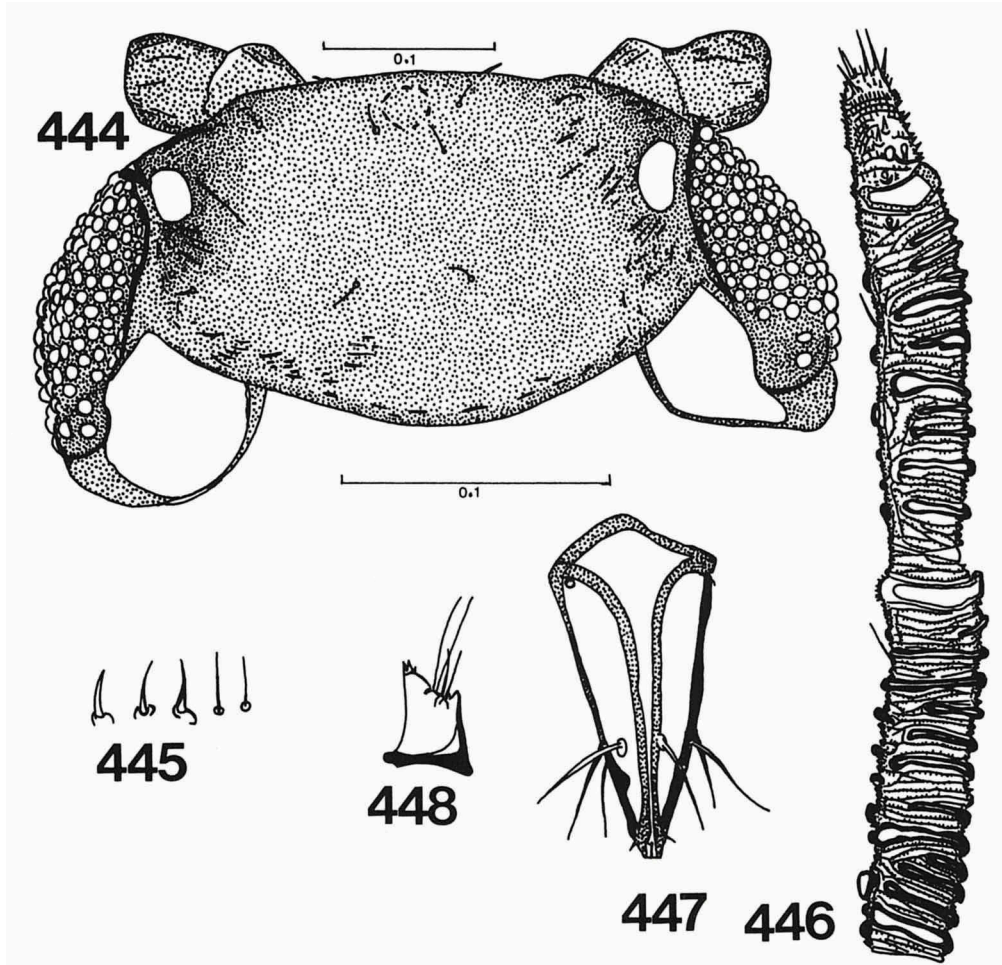

Figs. 444-448. *Rappardiella loranthi* (Van der Goot), alate viviparous ♀. Fig. 444, dorsal side of the head. Fig. 445, three frontal hairs (left) and two hairs dorsally on the head (right). Fig. 446, dorsal sides of antennal segments IV-V. Fig. 447, ultimate rostral segment. Fig. 448, first tarsal segment of the foreleg.

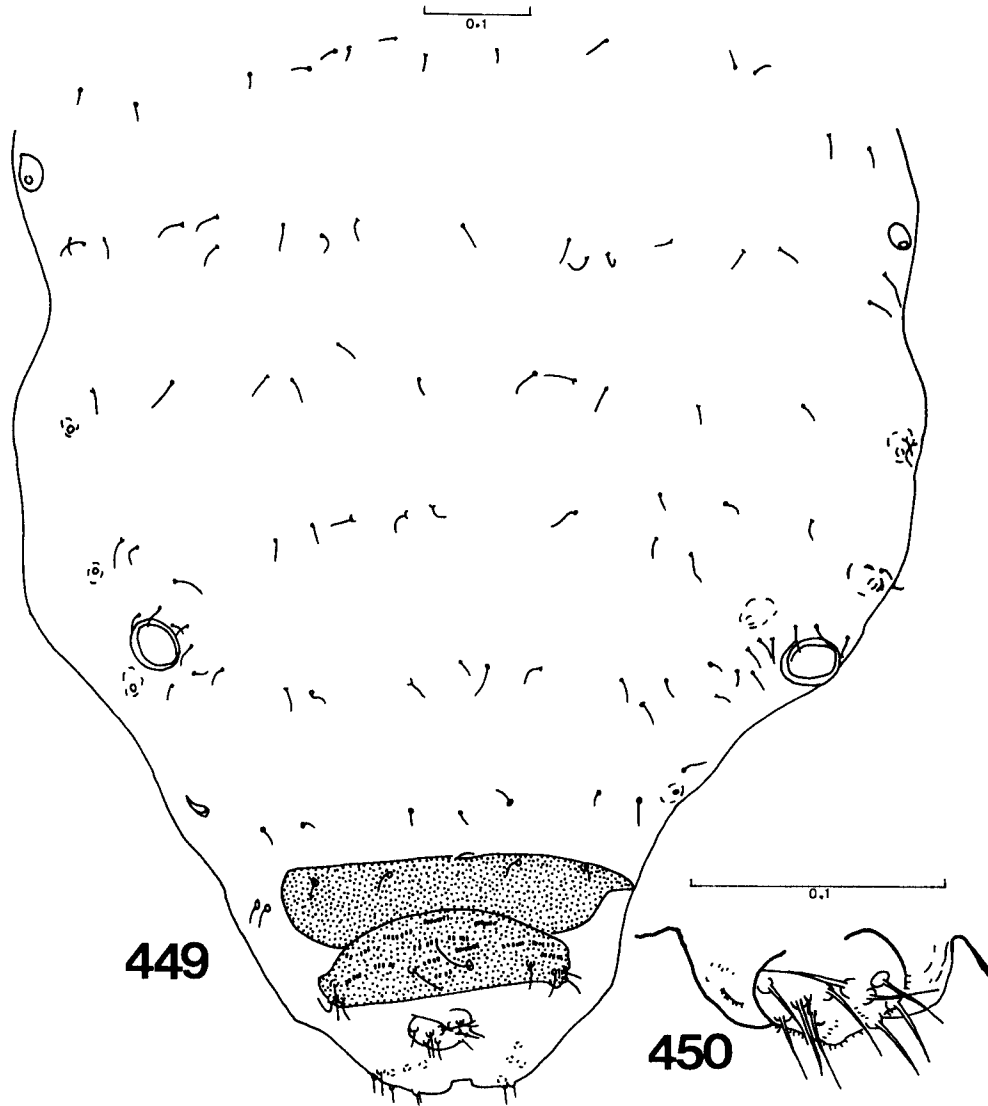

Figs. 449-450. *Rappardiella loranthi* (Van der Goot), alate viviparous ♀. Fig. 449, dorsal sides of abdominal segments I-VIII. Fig. 450, cauda.

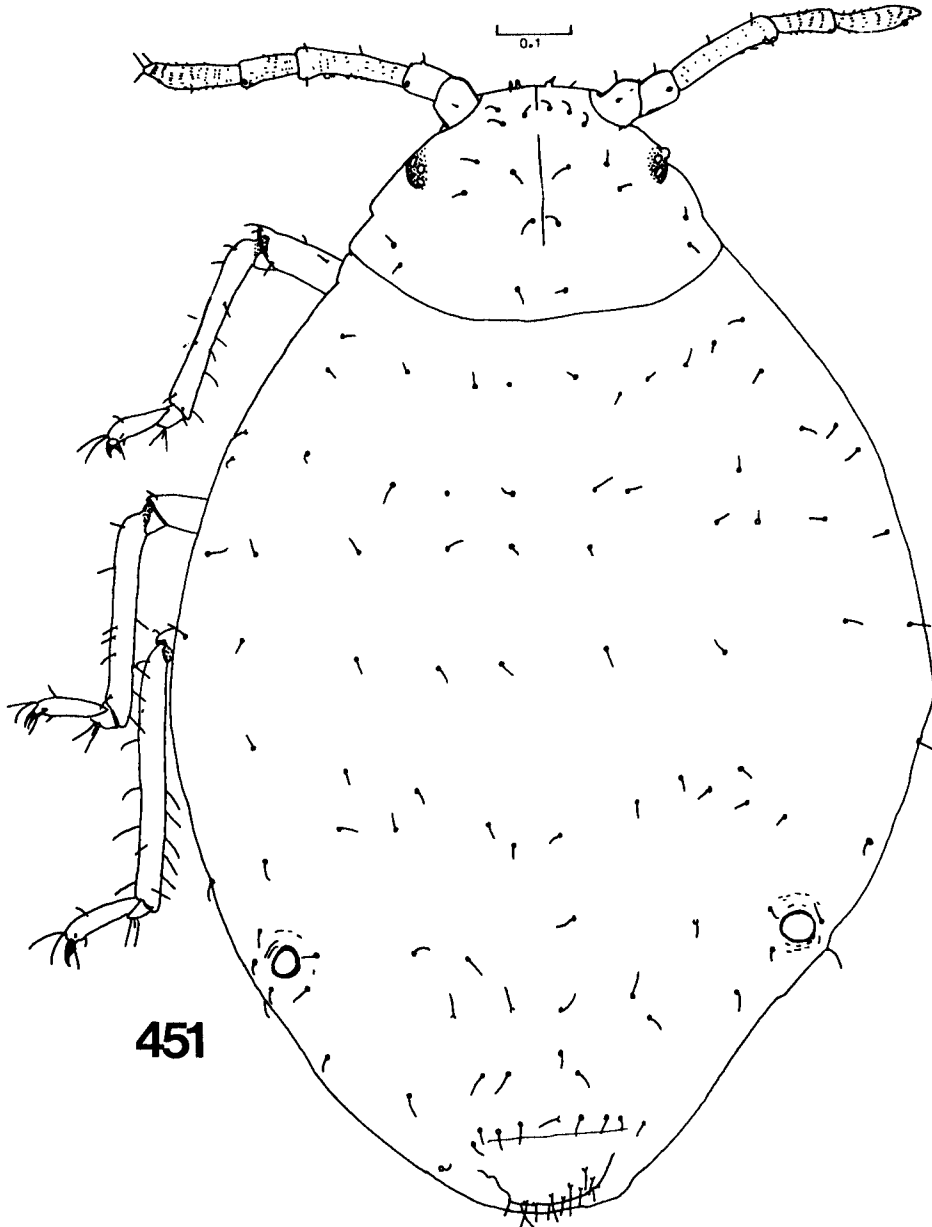
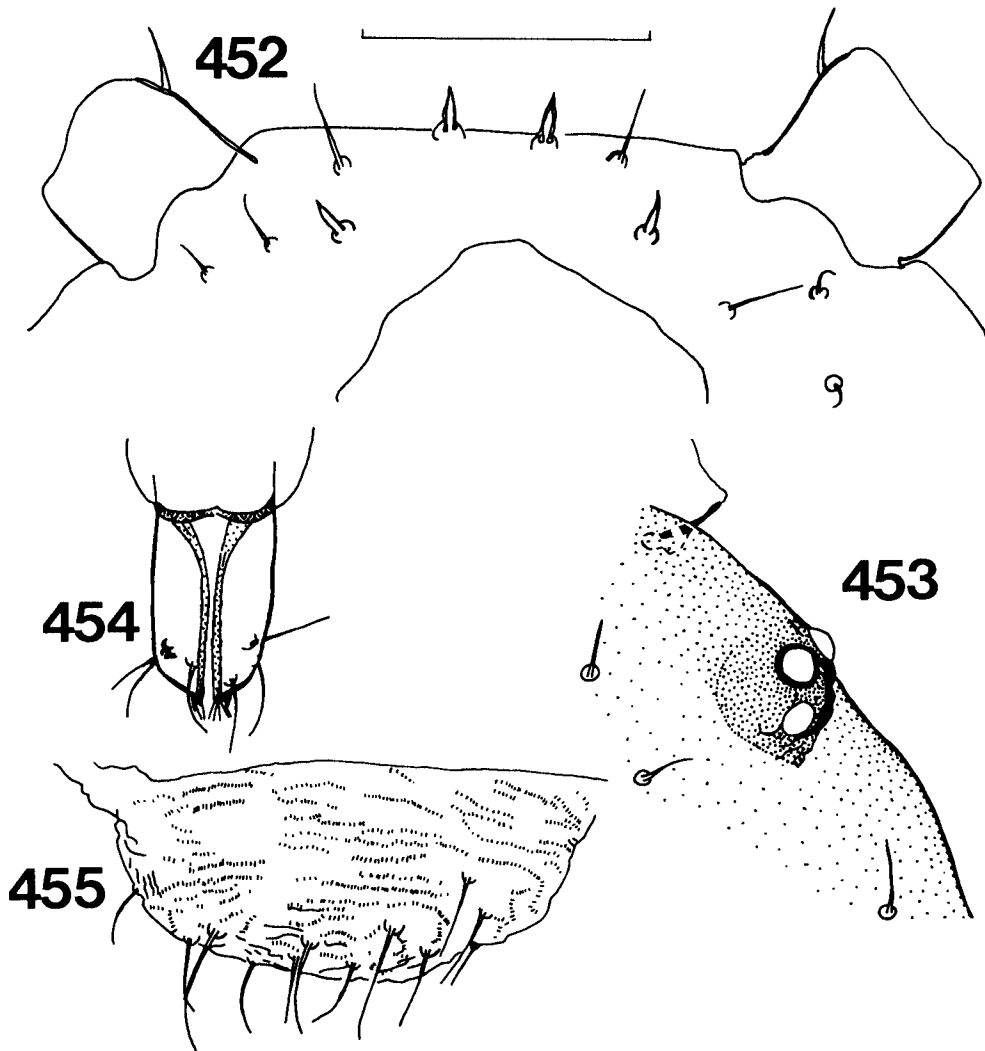
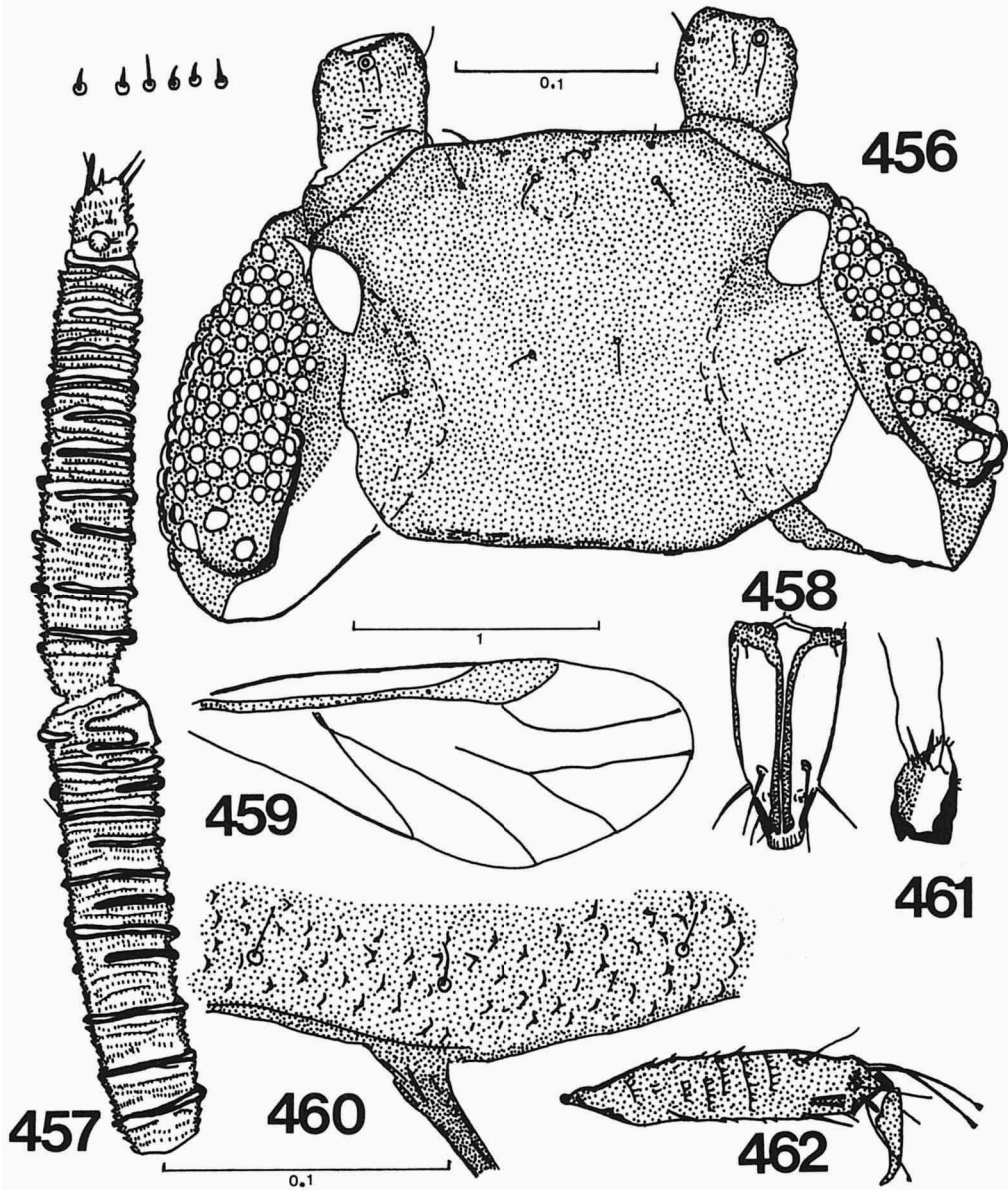

Fig. 451. *Rappardiella macrosoleni* spec. nov., apterous viviparous ♀, dorsal side of the body.





Figs. 452-455. *Rappardiella macrosoleni* spec. nov., apterous viviparous ♀. Fig. 452, ventral side of the anterior part of the head. Fig. 453, eye. Fig. 454, ultimate rostral segment. Fig. 455, cauda.



Figs. 456-462. *Rappardiella macrosoleni* spec. nov., alate viviparous ♀. Fig. 456, dorsal side of the head. On top left six small dagger hairs, ventrally on the head of some specimens. Fig. 457, dorsal sides of antennal segments IV-V. Fig. 458, ultimate rostral segment. Fig. 459, fore wing. Fig. 460, pterostigma and base of the radial sector. Fig. 461, first tarsal segment of the foreleg. Fig. 462, second tarsal segment of the hind leg.

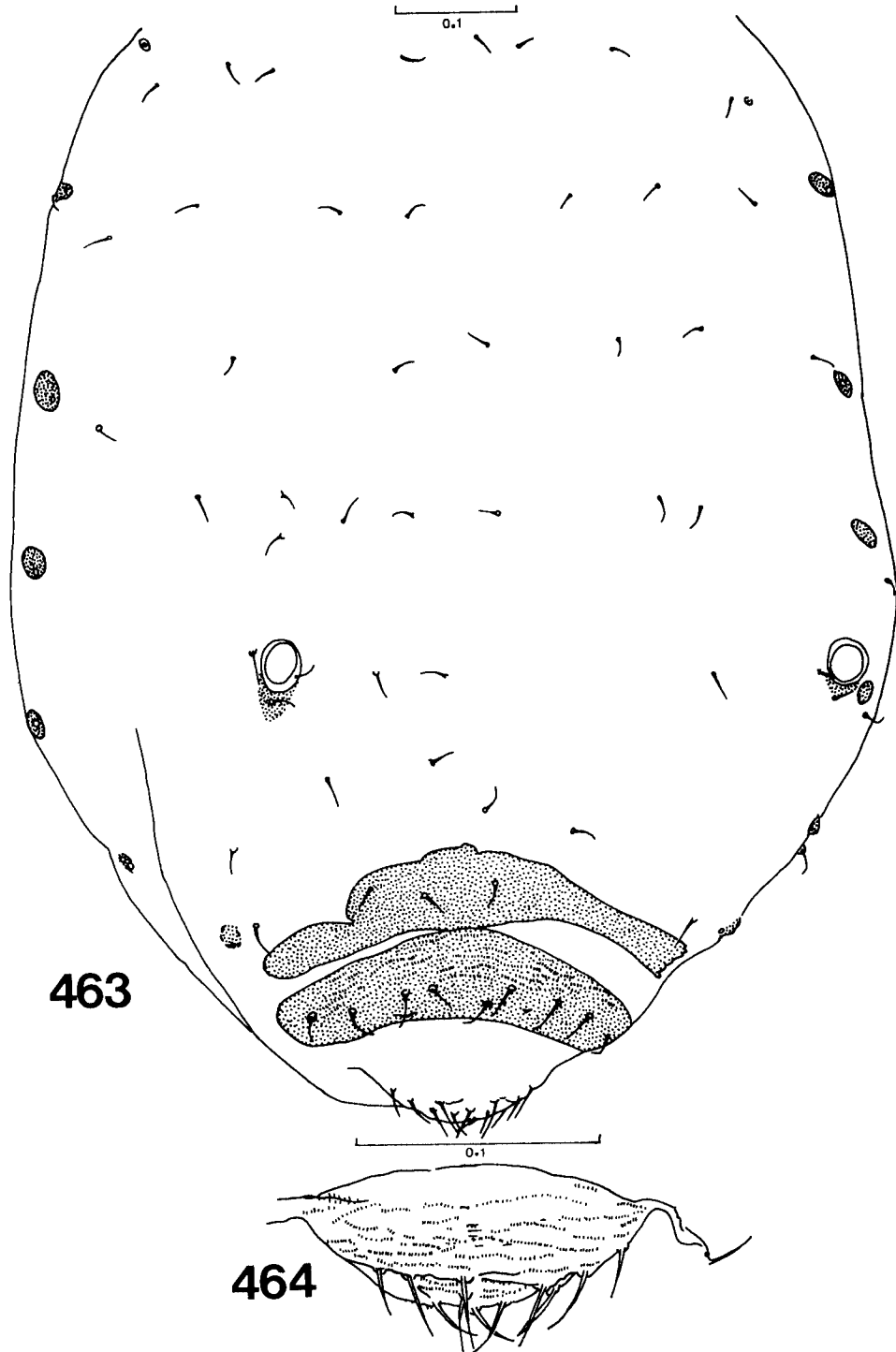

Figs. 463-464. *Rappardiella macrosoleni* spec. nov., alate viviparous ♀. Fig. 463, dorsal sides of abdominal segments I-VIII. Fig. 464, cauda.

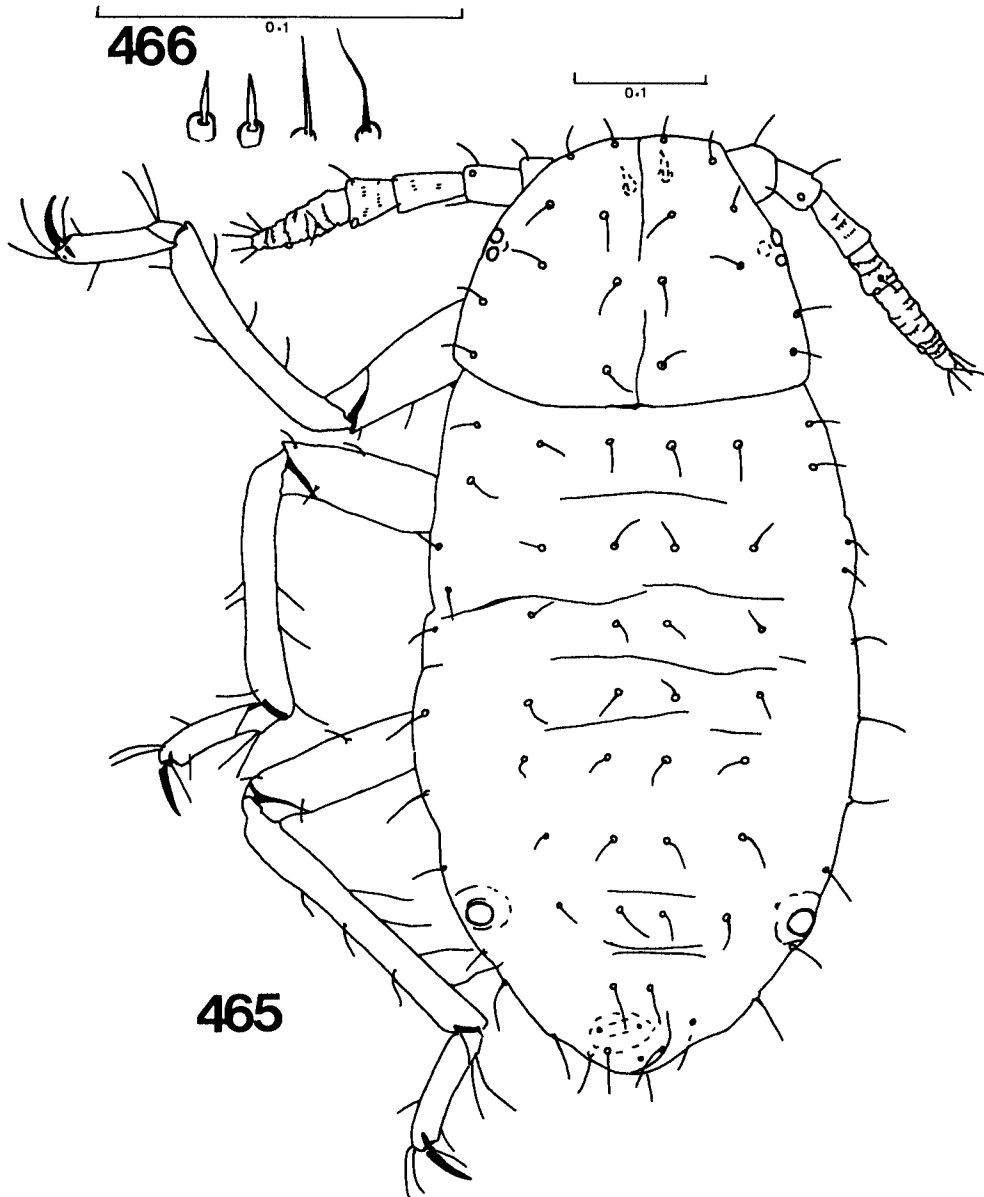

Figs. 465-466. *Rappardiella macrosoleni* spec. nov., first stage larva. Fig. 465, dorsal side of the body. Fig. 466, two ventral sturdy hairs of the head (left), and two normal dorsal hairs.

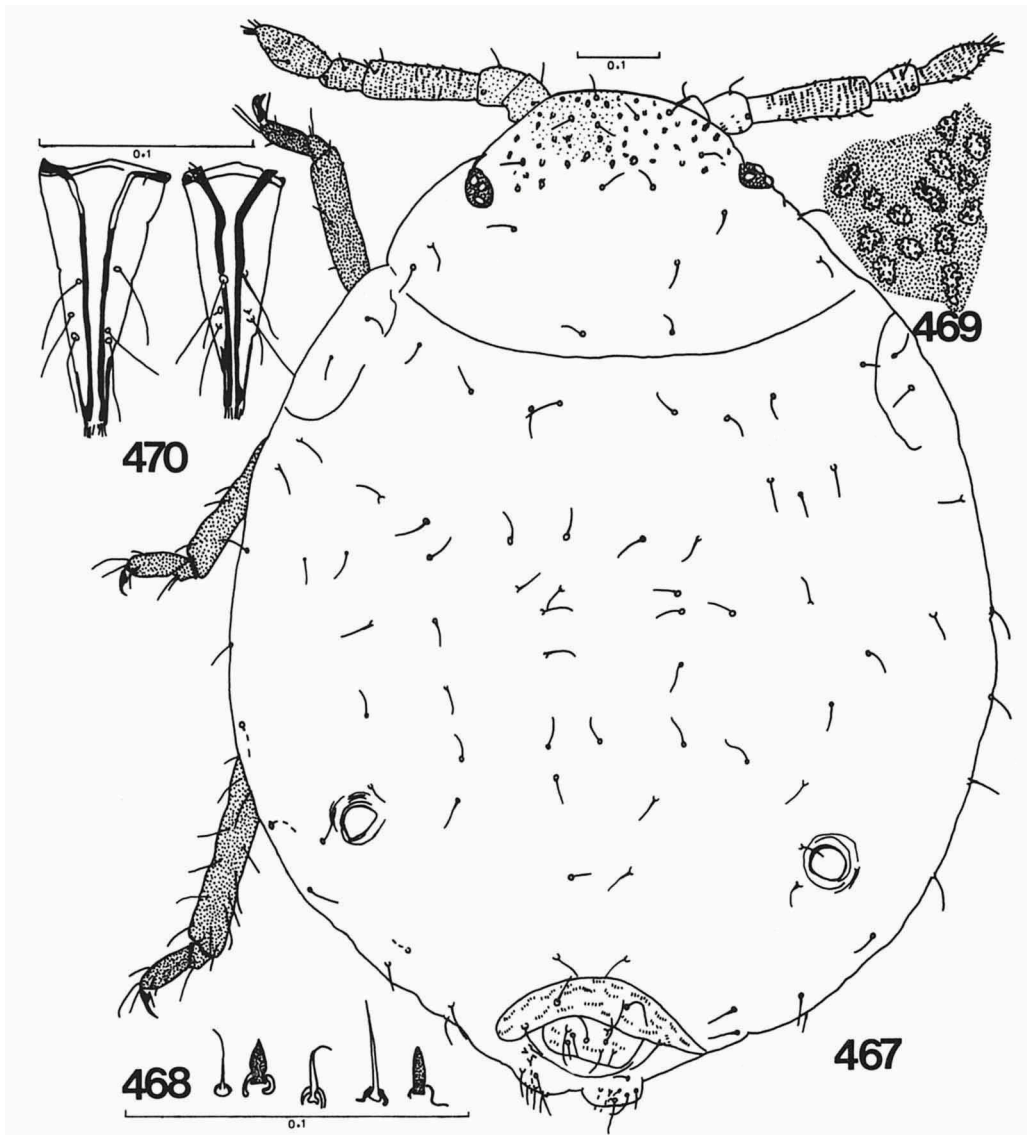

Figs. 467-470. *Rappardiella plicator* spec. nov., apterous viviparous ♀. Fig. 467, dorsal side of the body. Fig. 468, five hairs from the ventral side of the head of some specimens. Fig. 469, pustules dorsally on the head. Fig. 470, two ultimate rostral segments.

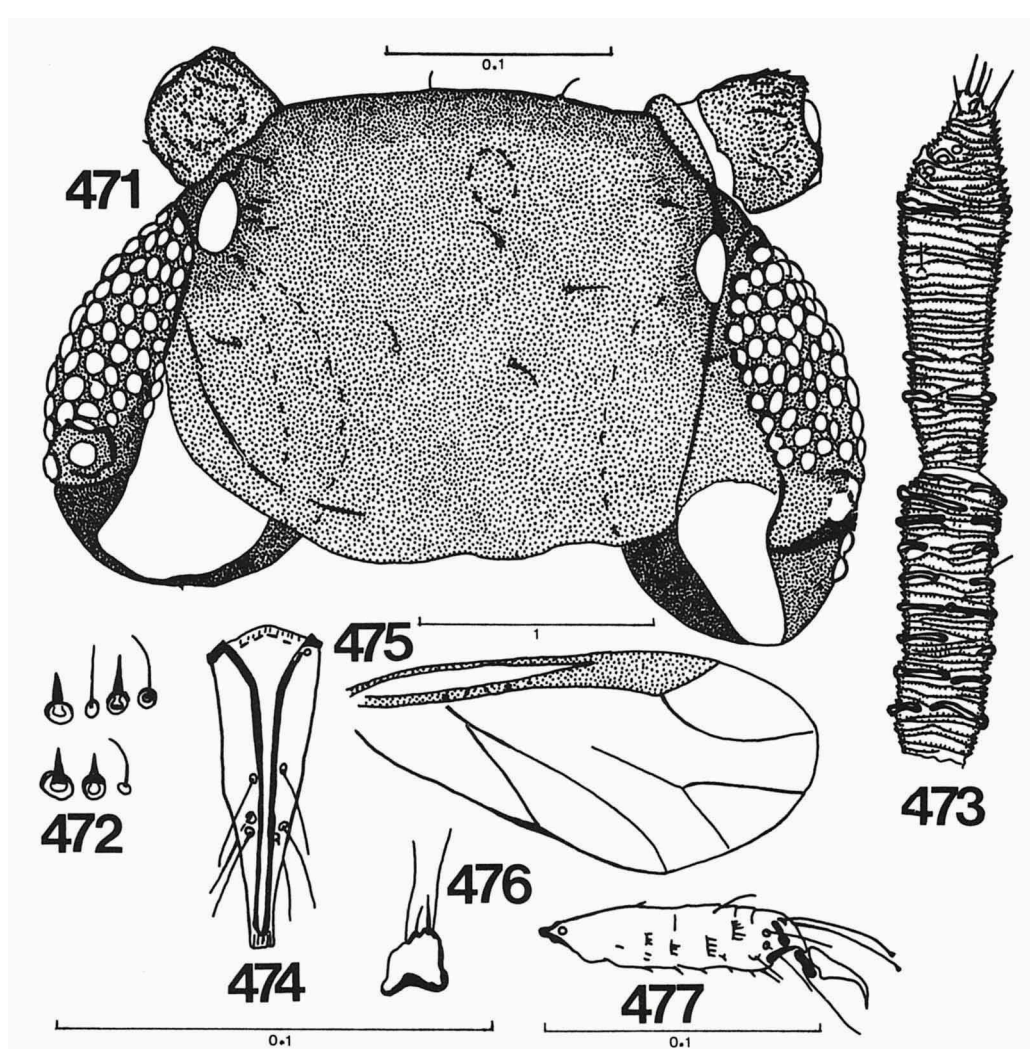

Figs. 471-477. *Rappardiella plicator* spec. nov., alate viviparous ♀. Fig. 471, dorsal side of the head. Fig. 472, ventral hairs from the head of some specimens. Fig. 473, dorsal sides of antennal segments IV-V. Fig. 474, ultimate rostral segment. Fig. 475, fore wing. Fig. 476, first tarsal segment of the foreleg. Fig. 477, second tarsal segment of the hind leg. The long 0.1 scale line below to fig. 472, the shorter to figs. 473, 474, 476 and 477.

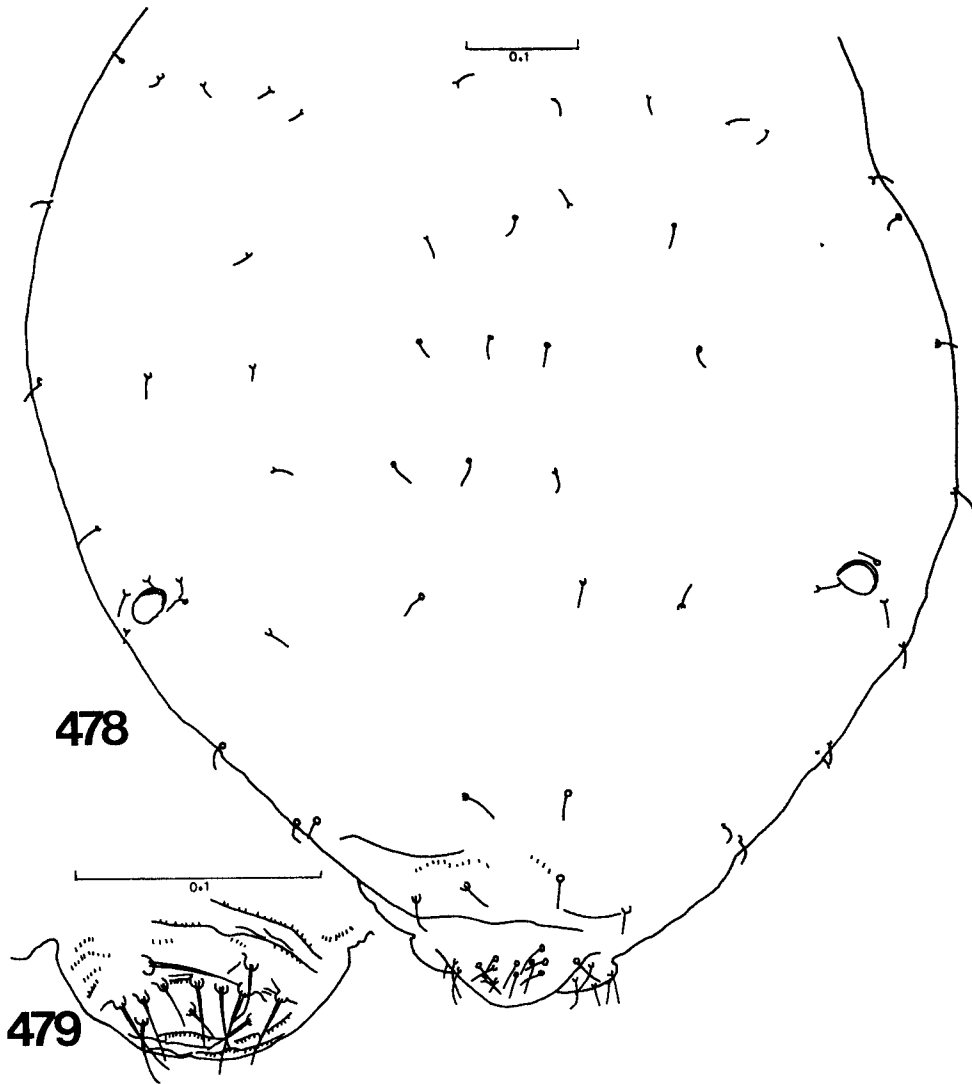

Figs. 478-479. *Rappardiella plicator* spec. nov., alate viviparous ♀. Fig. 478, dorsal sides of abdominal segments I-VIII. Fig. 479, cauda.

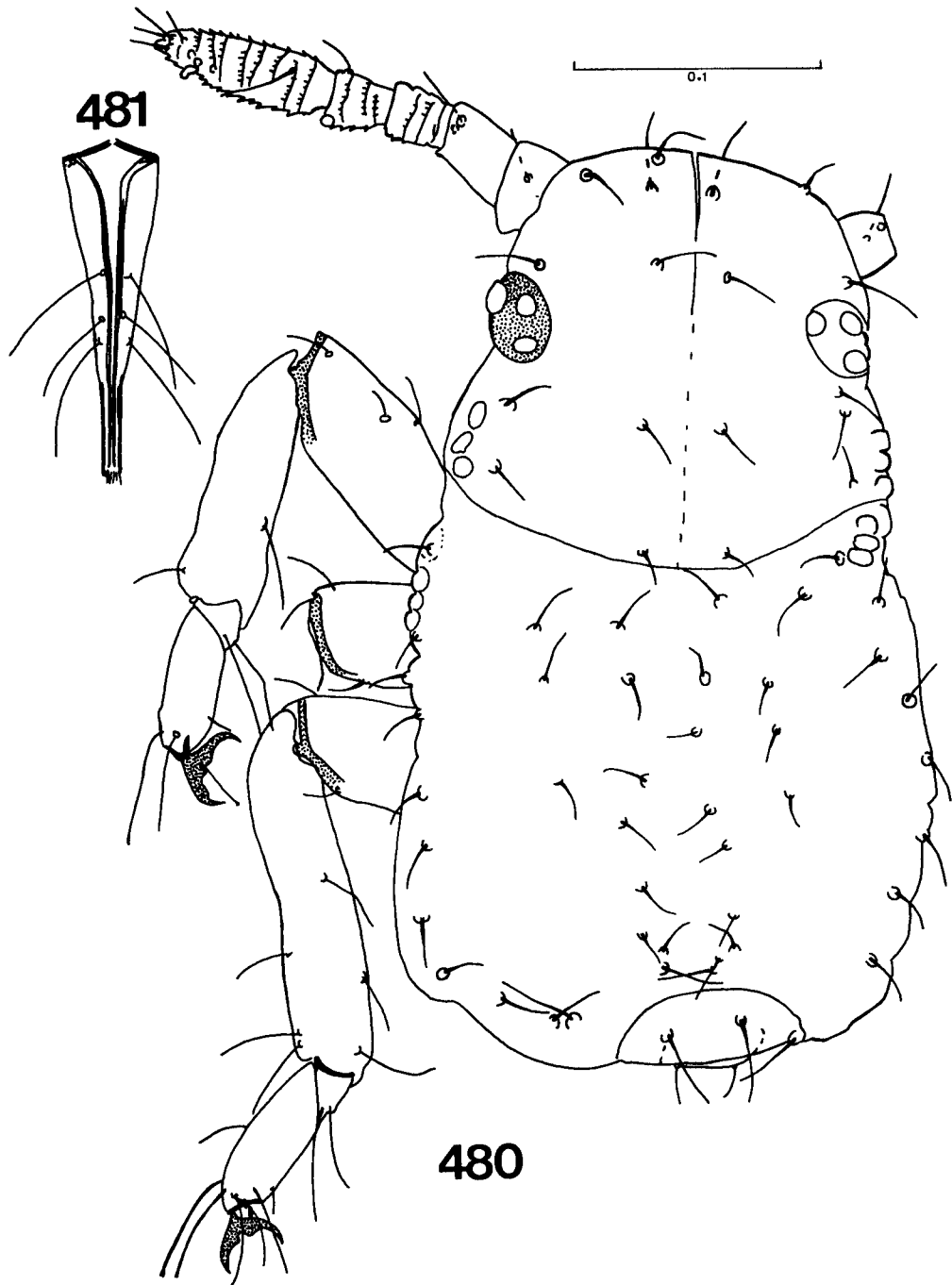

Figs. 480-481. *Rappardiella plicator* spec. nov., first stage larva. Fig. 480, dorsal side of the body. Fig. 481, ultimate rostral segment.



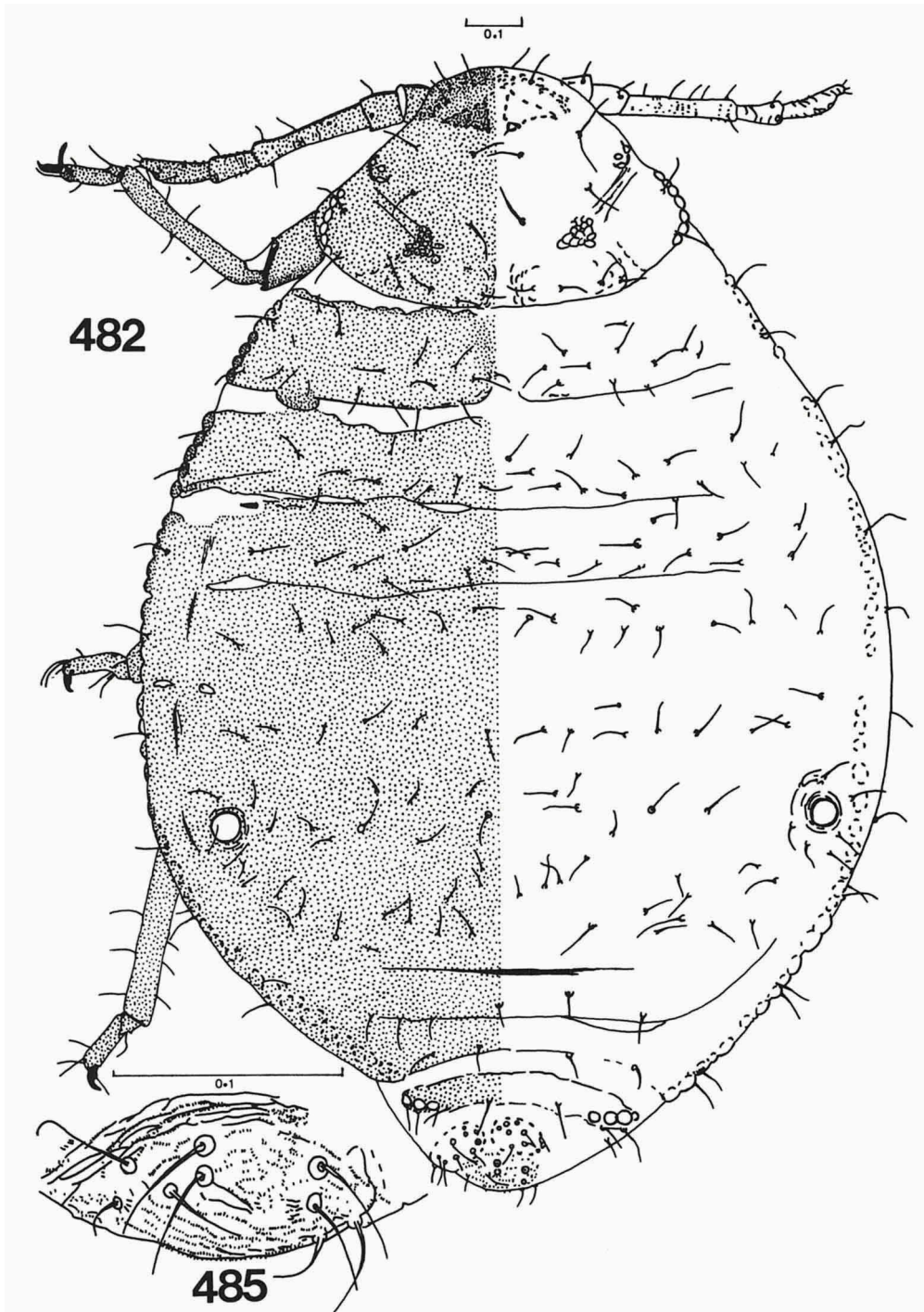

Figs. 482, 485. *Rappardiella scurrulae* spec. nov., apterous viviparous ♀. Fig. 482, dorsal side of the body. Fig. 485, cauda.

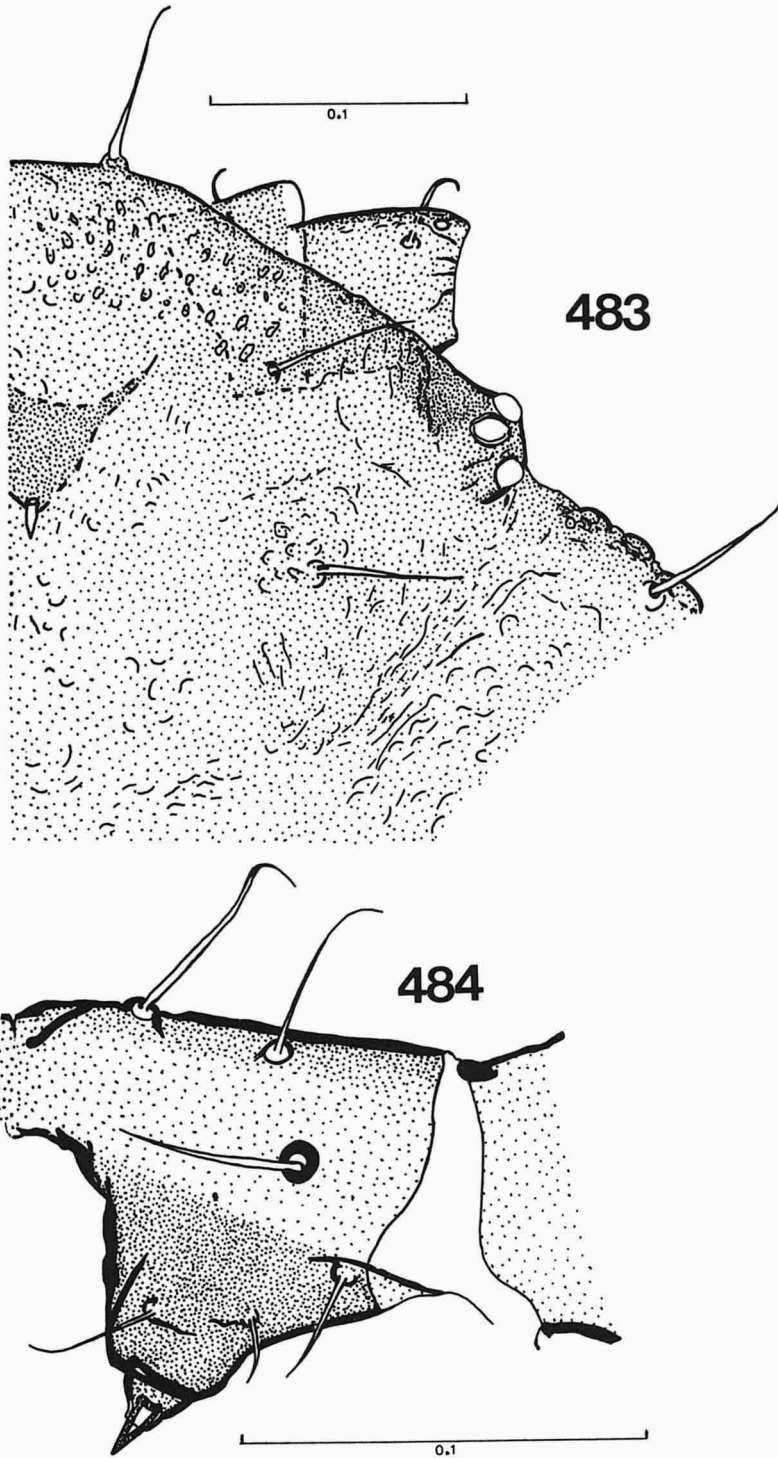

Figs. 483, 484. *Rappardiella scurrulae* spec. nov., apterous viviparous ♀. Fig. 483, part of the dorsal side of the head. Fig. 484, ventral side of the head with horn pointing backwards.

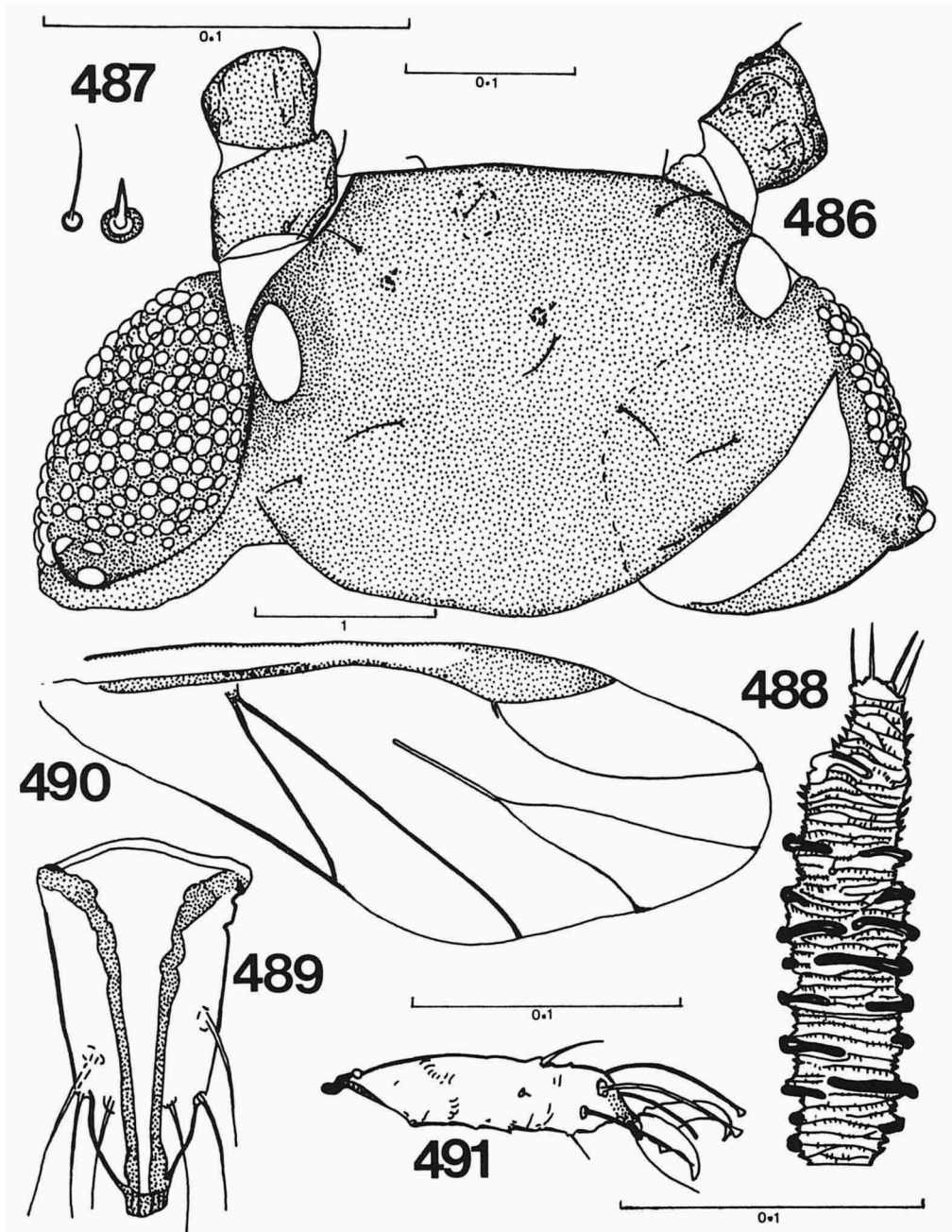

Figs. 486-491. *Rappardiella scurrulae* spec. nov., alate viviparous ♀. Fig. 486, dorsal side of the head. Fig. 487, ventral hairs of the head, normal hair (left), and dagger hair (right). Fig. 488, dorsal side of antennal segment V. Fig. 489, ultimate rostral segment. Fig. 490, fore wing. Fig. 491, second tarsal segment of the hind leg. Scale line 0.1 below to figs. 488, 489.

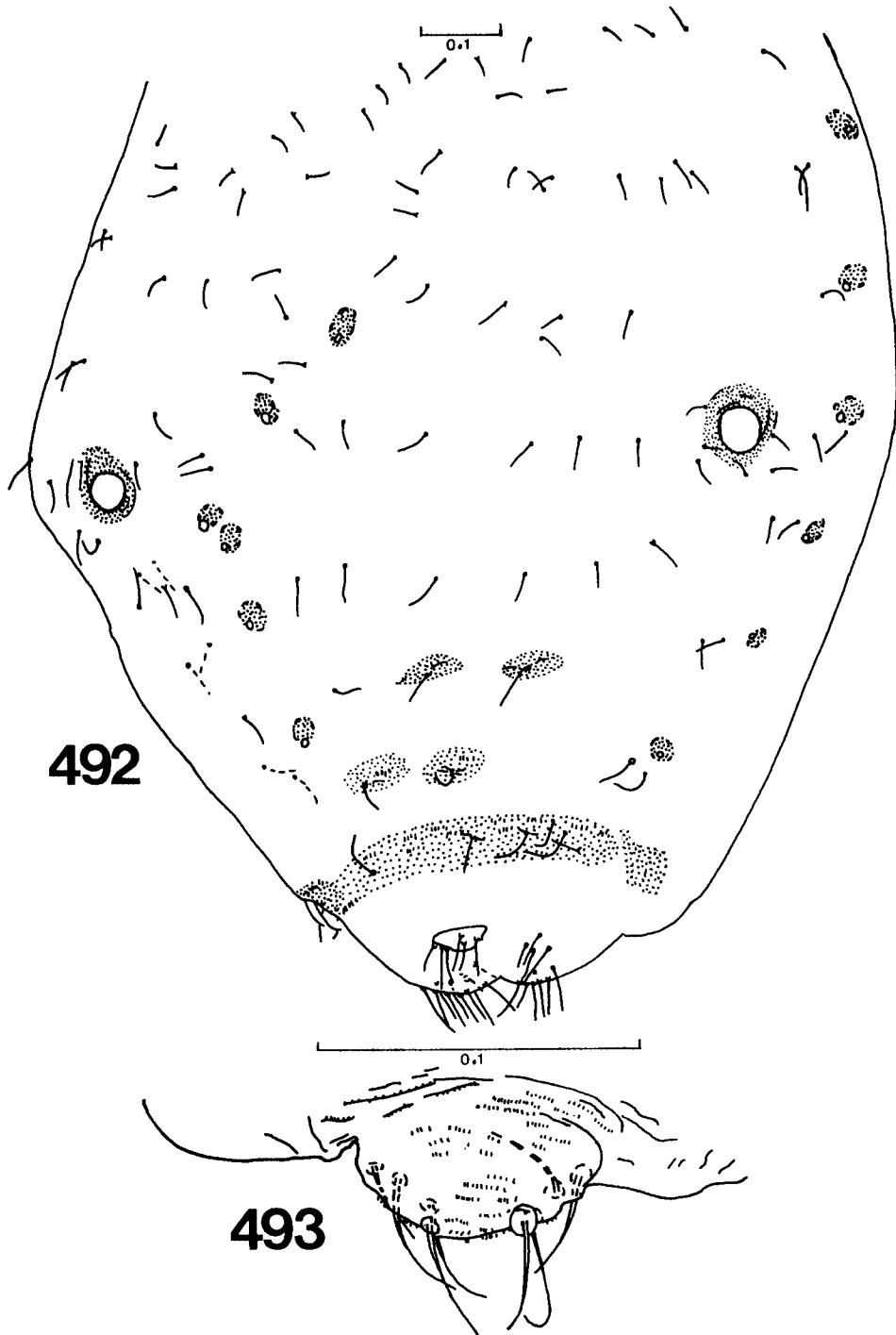

Figs. 492-493. *Rappardiella scurrulae* spec. nov., alate viviparous ♀. Fig. 492, dorsal sides of abdominal segments I-VIII. Fig. 493, cauda.

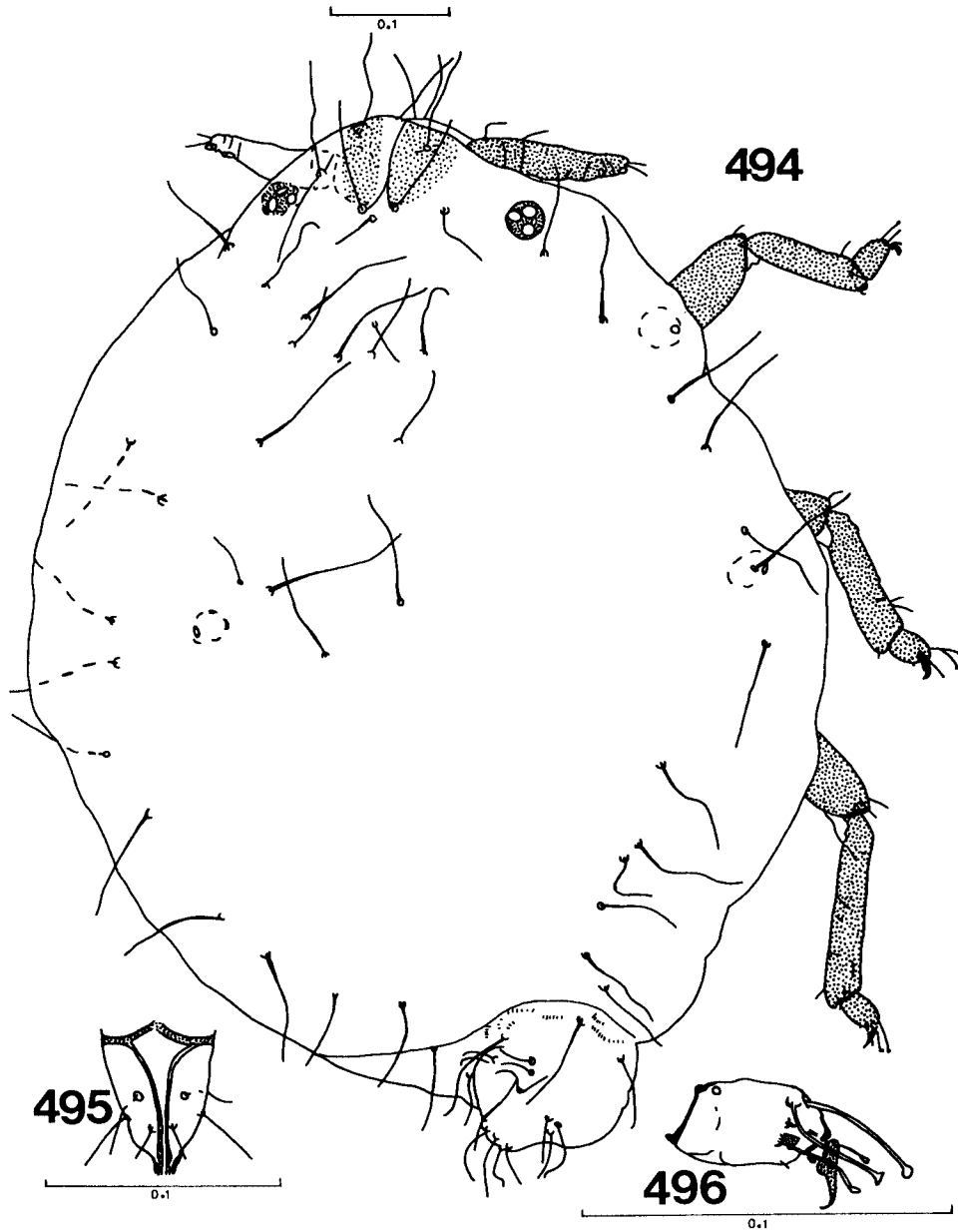

Figs. 494-496. *Reticulaphis distylis* (Van der Goot), apterous viviparous ♀ from gall No. 4 of *Distylium stellare*. Fig. 494, dorsal side of the body. Fig. 495, ultimate rostral segment. Fig. 496, first plus second tarsal segments of the hind leg.

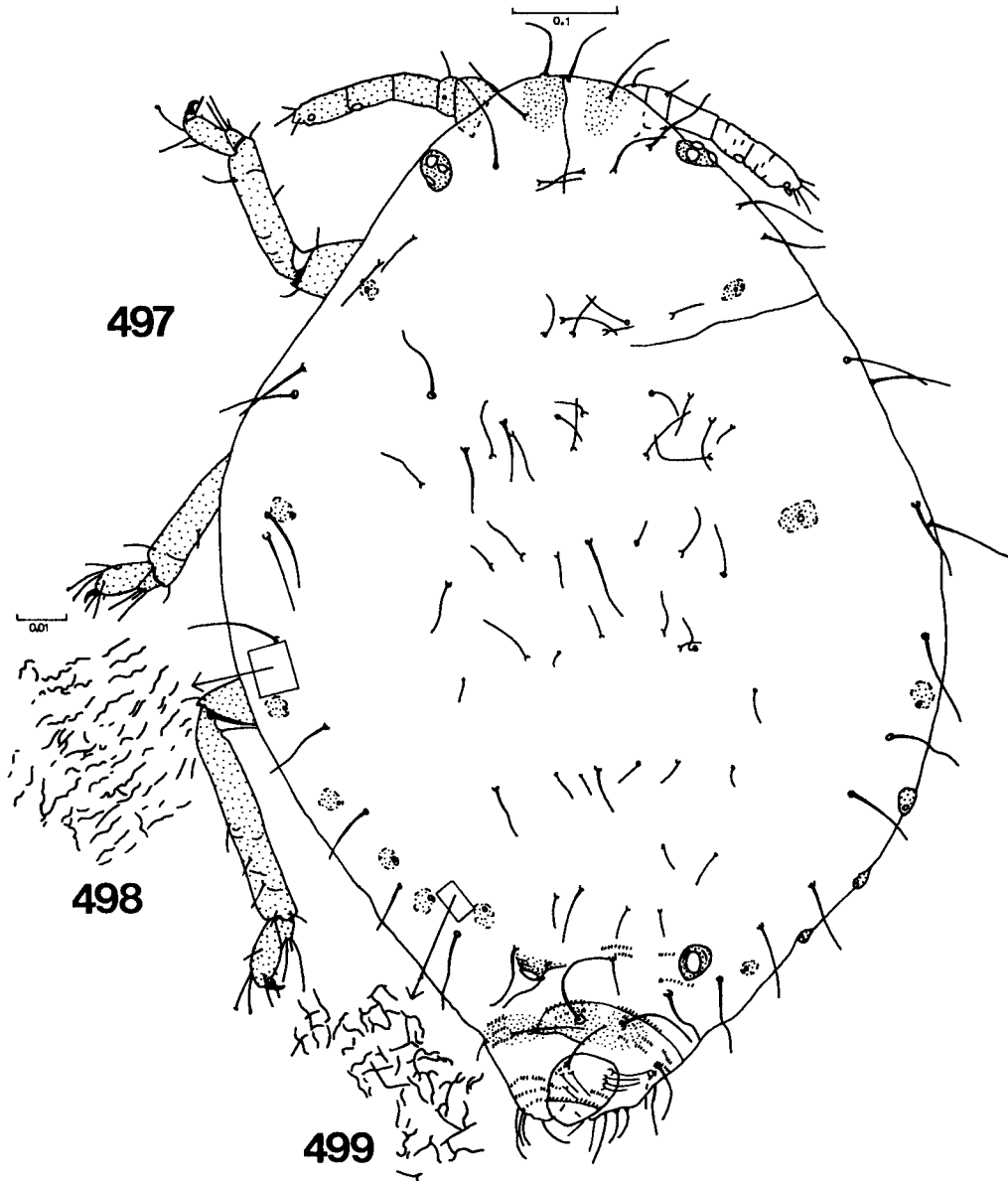

Figs. 497-499. *Reticulaphis distylii* (Van der Goot), apterous viviparous ♀, of next generations. Fig. 497, dorsal side of the body. Figs. 498-499, lines marginally on abdominal segments II-V.

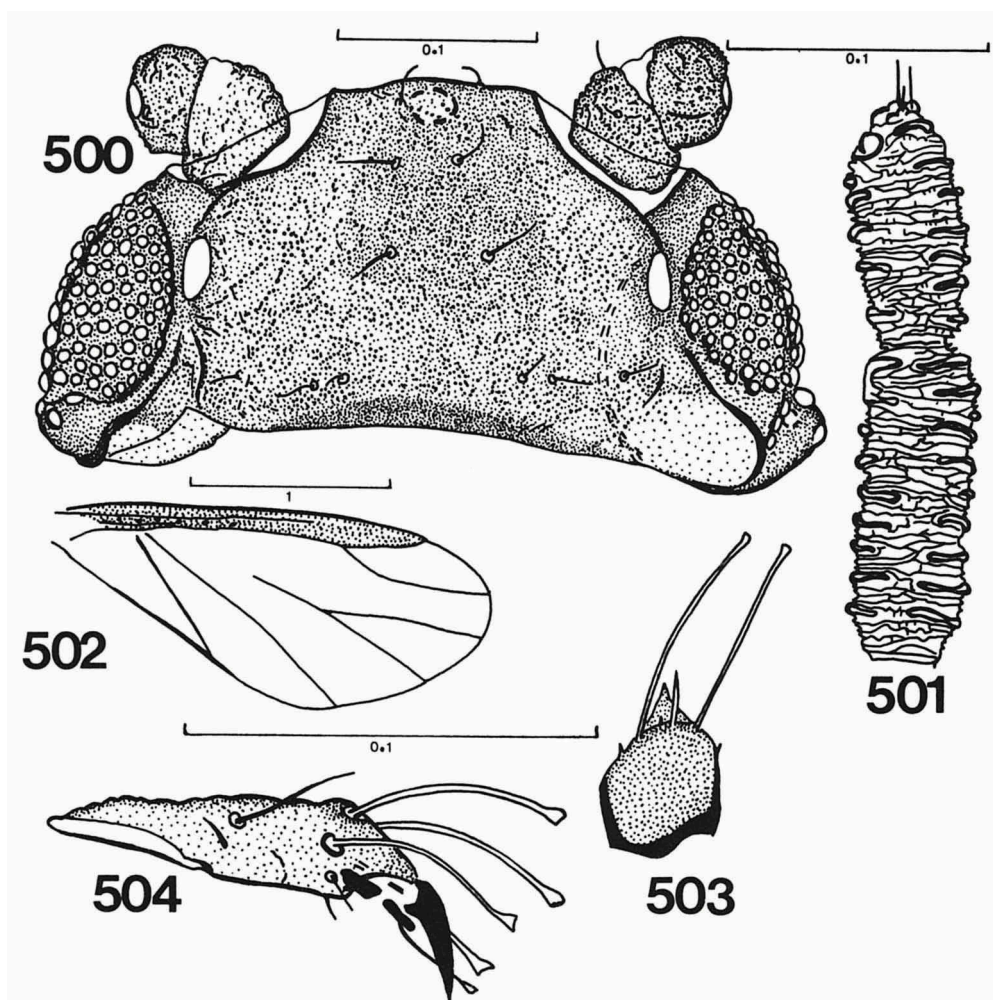

Figs. 500-504. *Reticulaphis distyliae* (Van der Goot), alate viviparous ♀ from gall No. 4 of *Distylium stellare*. Fig. 500, dorsal side of the head. Fig. 501, dorsal sides of antennal segments IV-V. Fig. 502, fore wing. Fig. 503, first tarsal segment of the foreleg. Fig. 504, second tarsal segment of the hind leg.

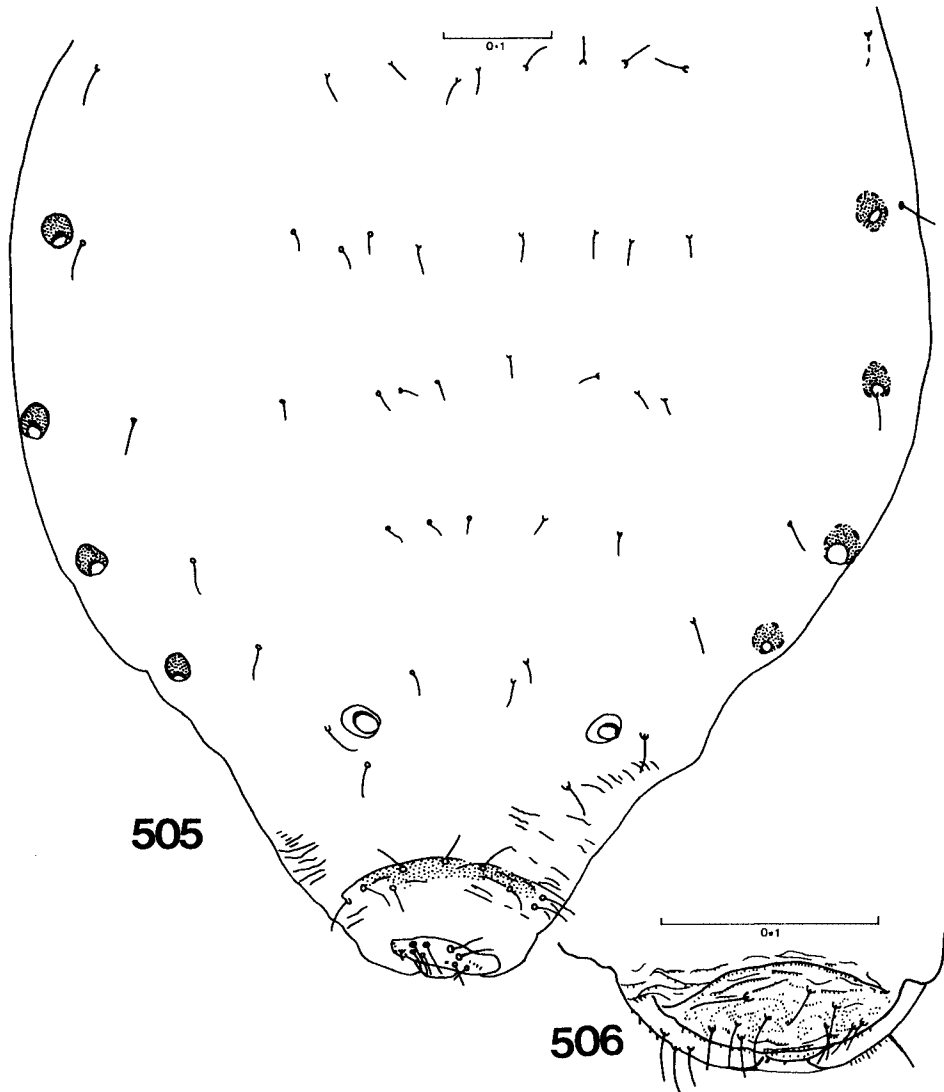

Figs. 505-506. *Reticulaphis distylii* (Van der Goot), alate viviparous ♀ from gall No. 4 of *Distylium stellare*. Fig. 505, dorsal side of abdominal segments I-VIII. Fig. 506, cauda.



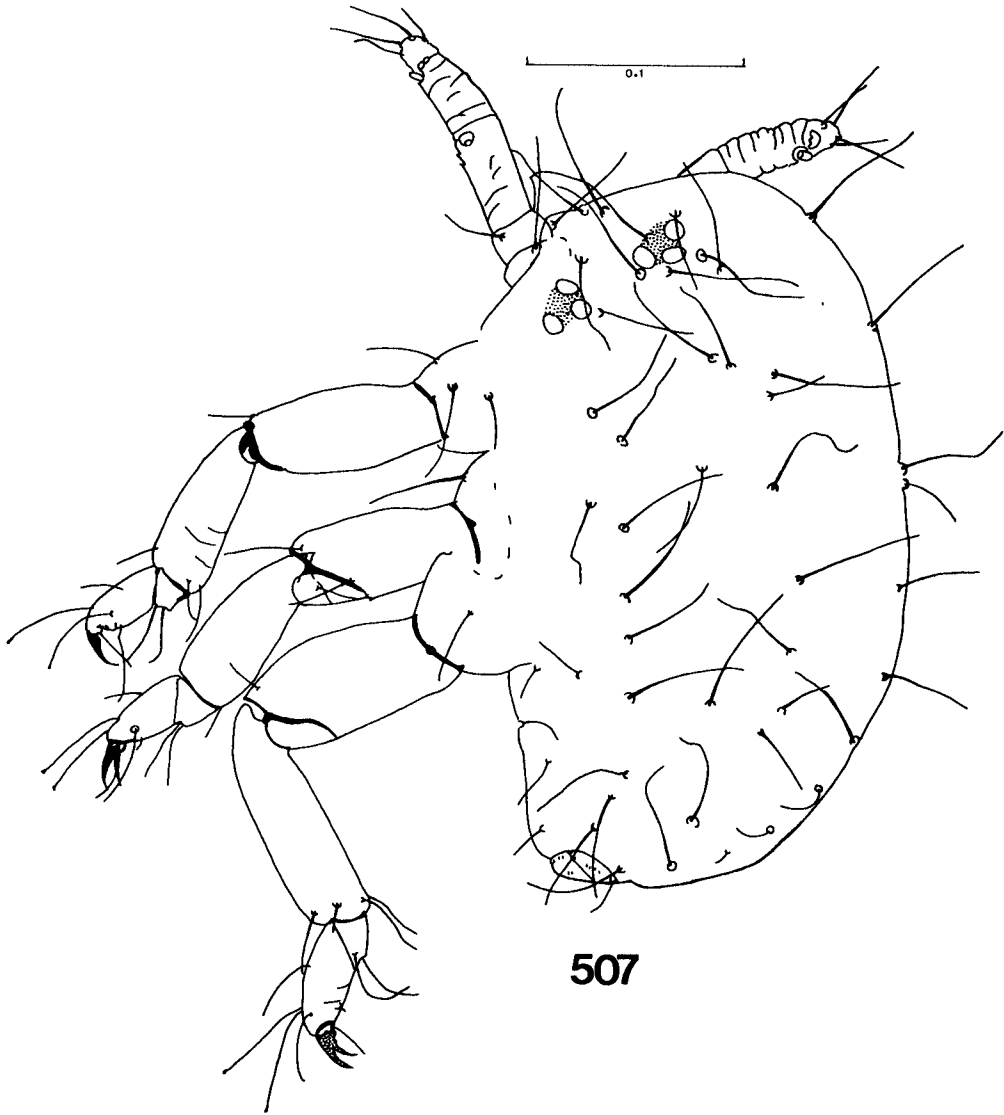
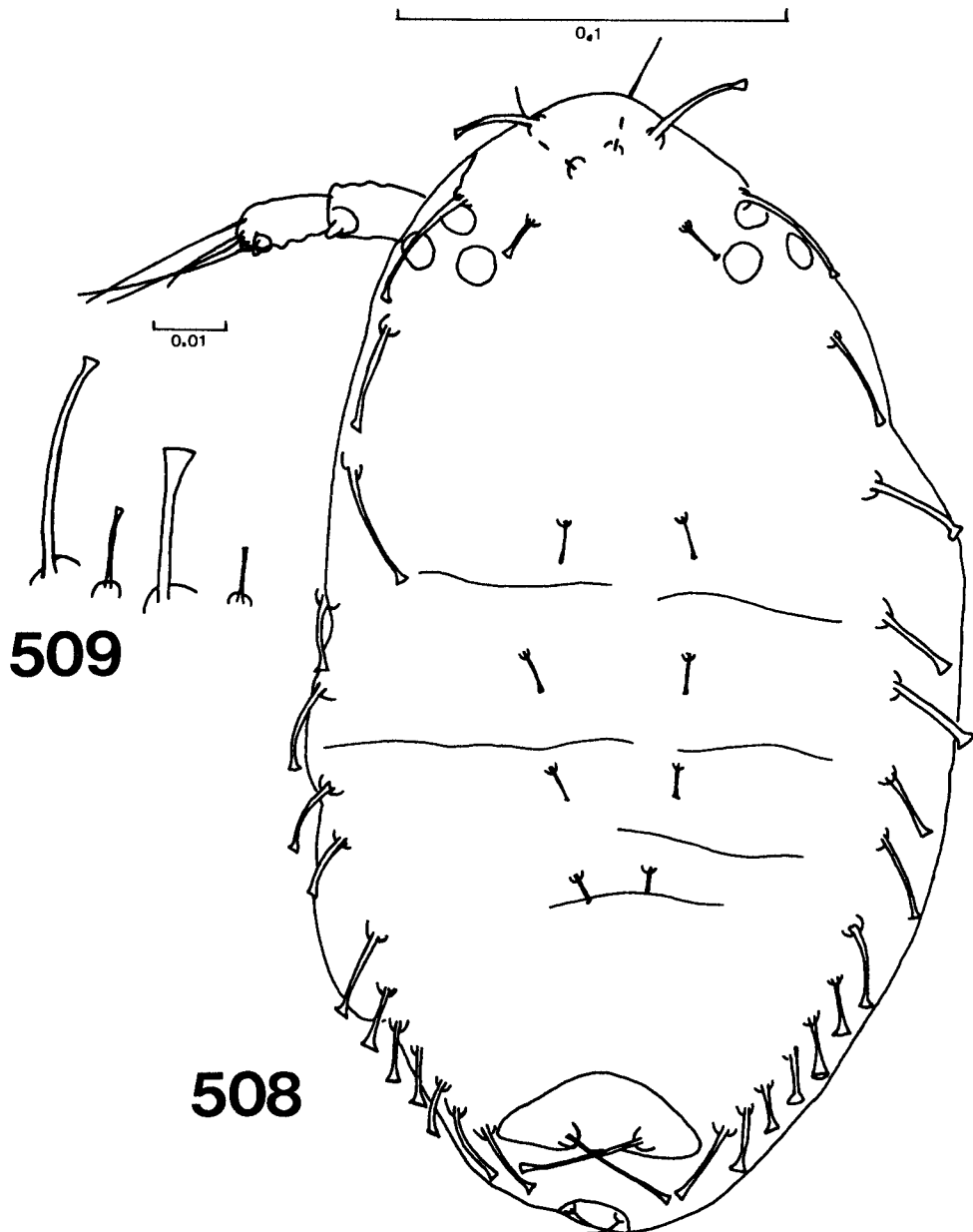
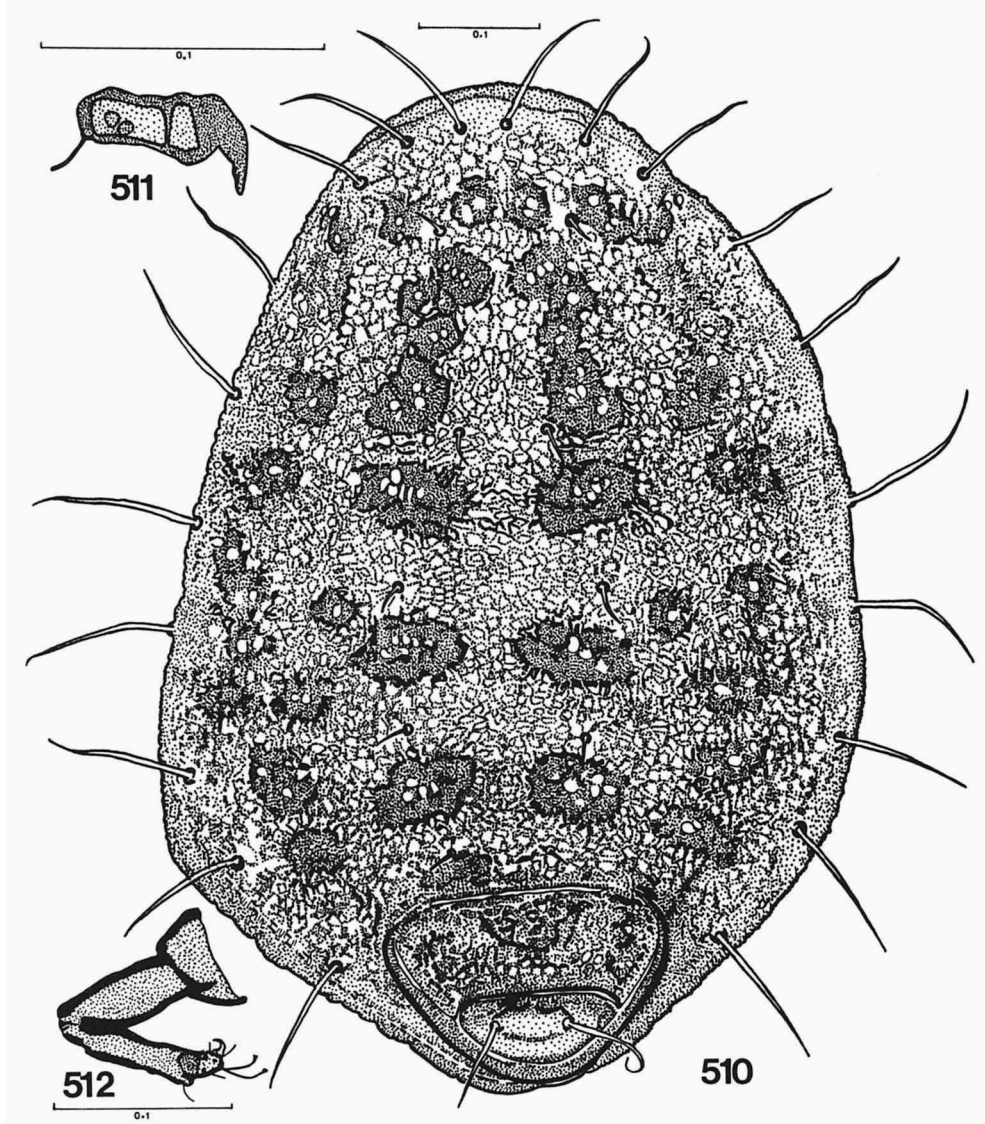

Fig. 507. *Reticulaphis distylii* (Van der Goot), first stage larva from gall No. 4 of *Distylium stellare*, dorsal side of the body.



Figs. 508-509. *Reticulaphis distyliae* (Van der Goot), embryo inside alate viviparous ♀ from gall No. 4 of *Distylium stellare*. Fig. 508, dorsal side of the body. Fig. 509, two hairs dorsally from the head (left), and two hairs marginally and dorsally from the mesothorax respectively (right).



Figs. 510-512. *Reticulaphis distylii* (Van der Goot), apterous viviparous ♀ from leaf of *Ficus*. Fig. 510, dorsal side of the body. Fig. 511, antenna. Fig. 512, hind leg.

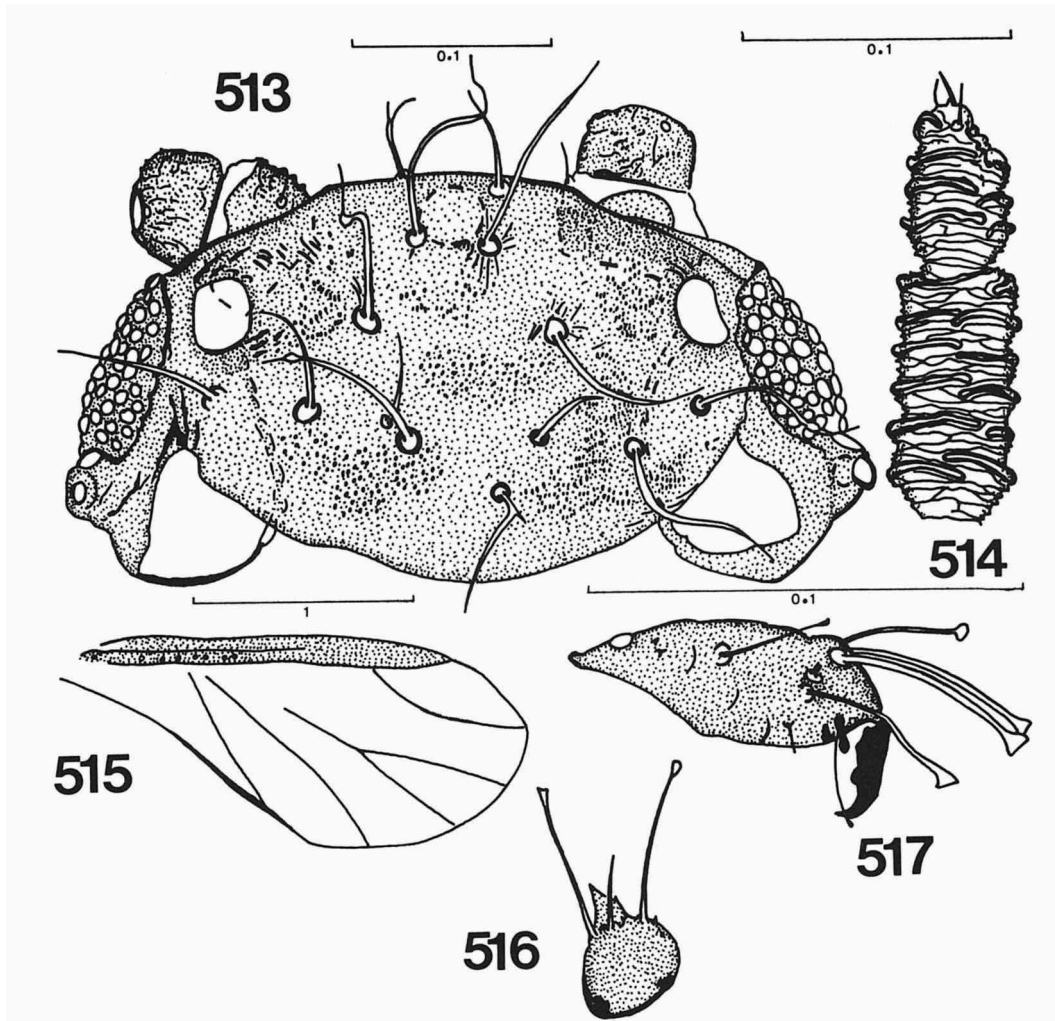

Figs. 513-517. *Reticulaphis distylis* (Van der Goot), alate viviparous ♀ from leaf of *Ficus*. Fig. 513, dorsal side of the head. Fig. 514, dorsal side of antennal segment V. Fig. 515, fore wing. Fig. 516, first tarsal segment of the foreleg. Fig. 517, second tarsal segment of the hind leg.

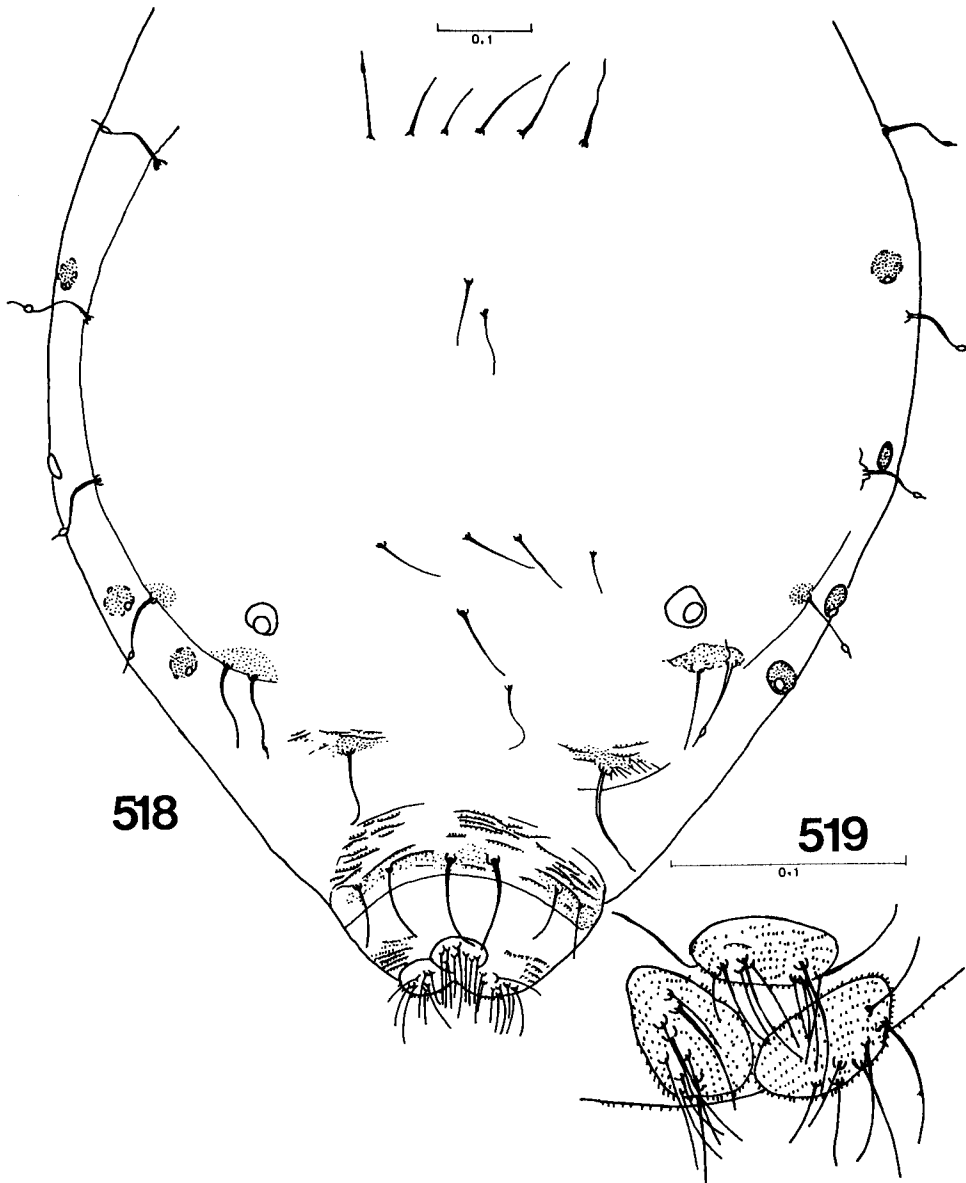

Figs. 518-519. *Reticulaphis distylis* (Van der Goot), alate viviparous ♀ from leaf of *Ficus*. Fig. 518, dorsal sides of abdominal segments I-VIII. Fig. 519, cauda and anal plate.

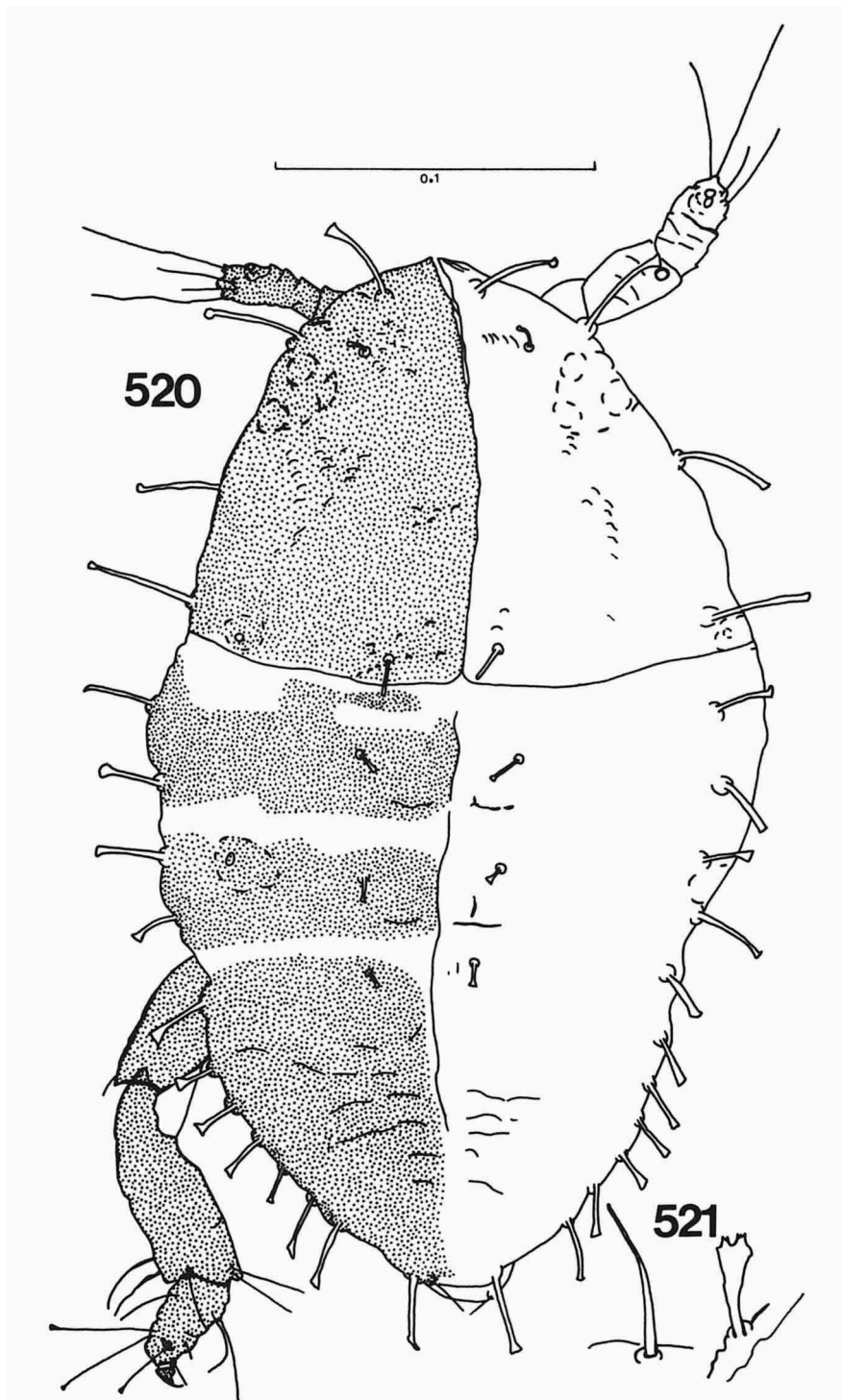

Figs. 520-521. *Reticulaphis distylii* (Van der Goot). Fig. 520, first stage larva of leaf of *Ficus*, dorsal side of the body. Fig. 521, third stage larva, hair of the metathorax (left); the corresponding hair of the adult (right), is seen inside the body of this larva which was near to moulting.

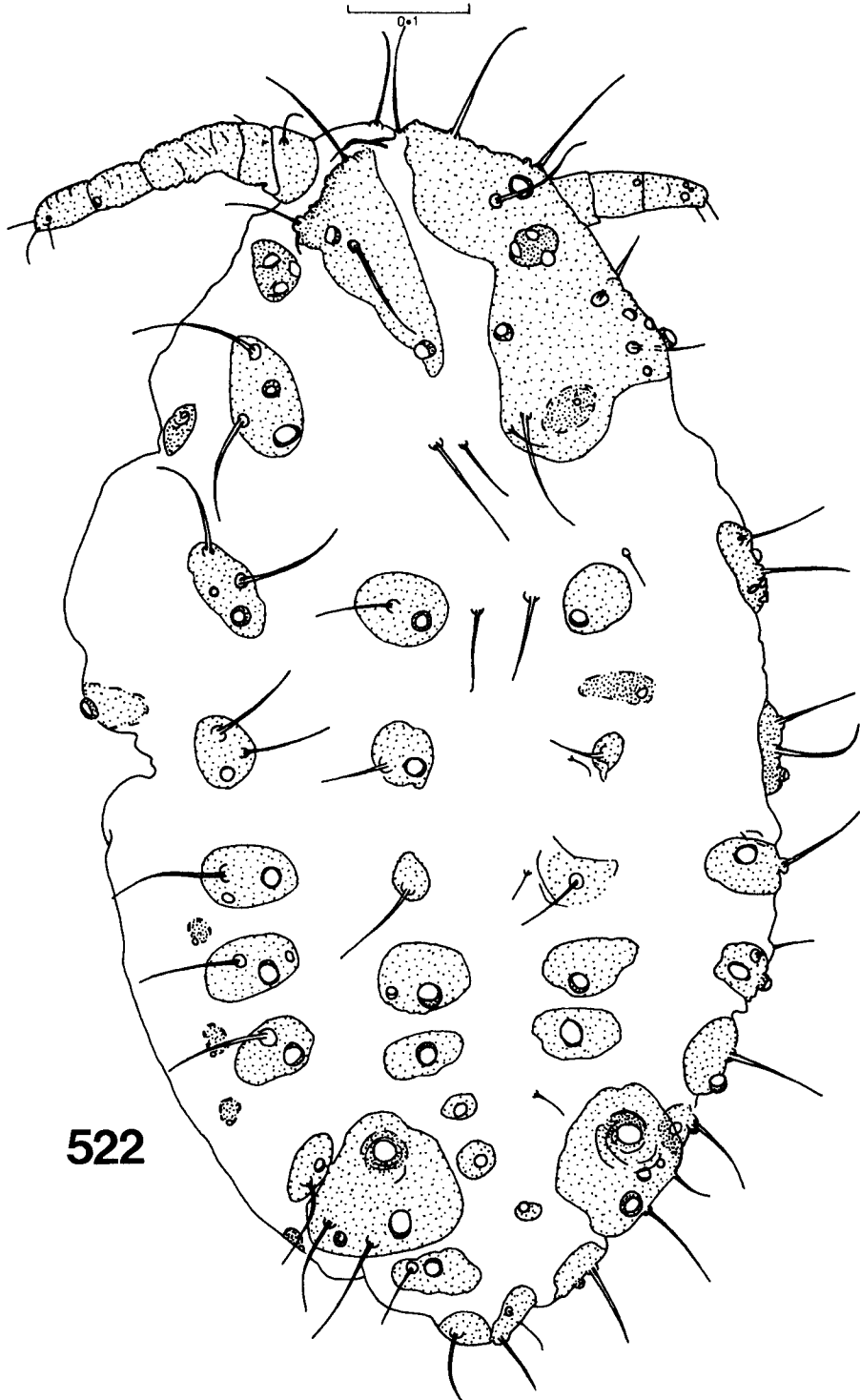
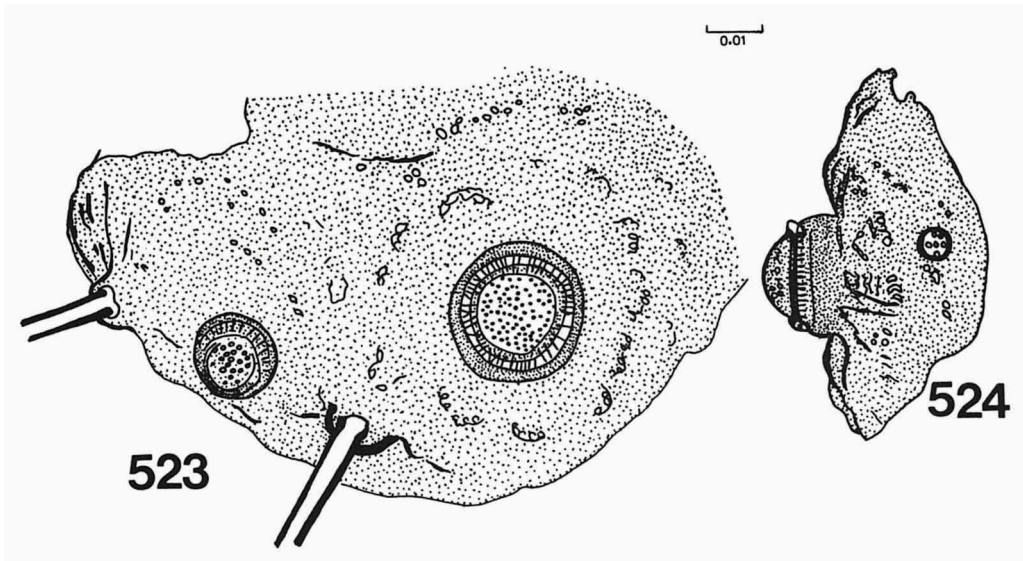
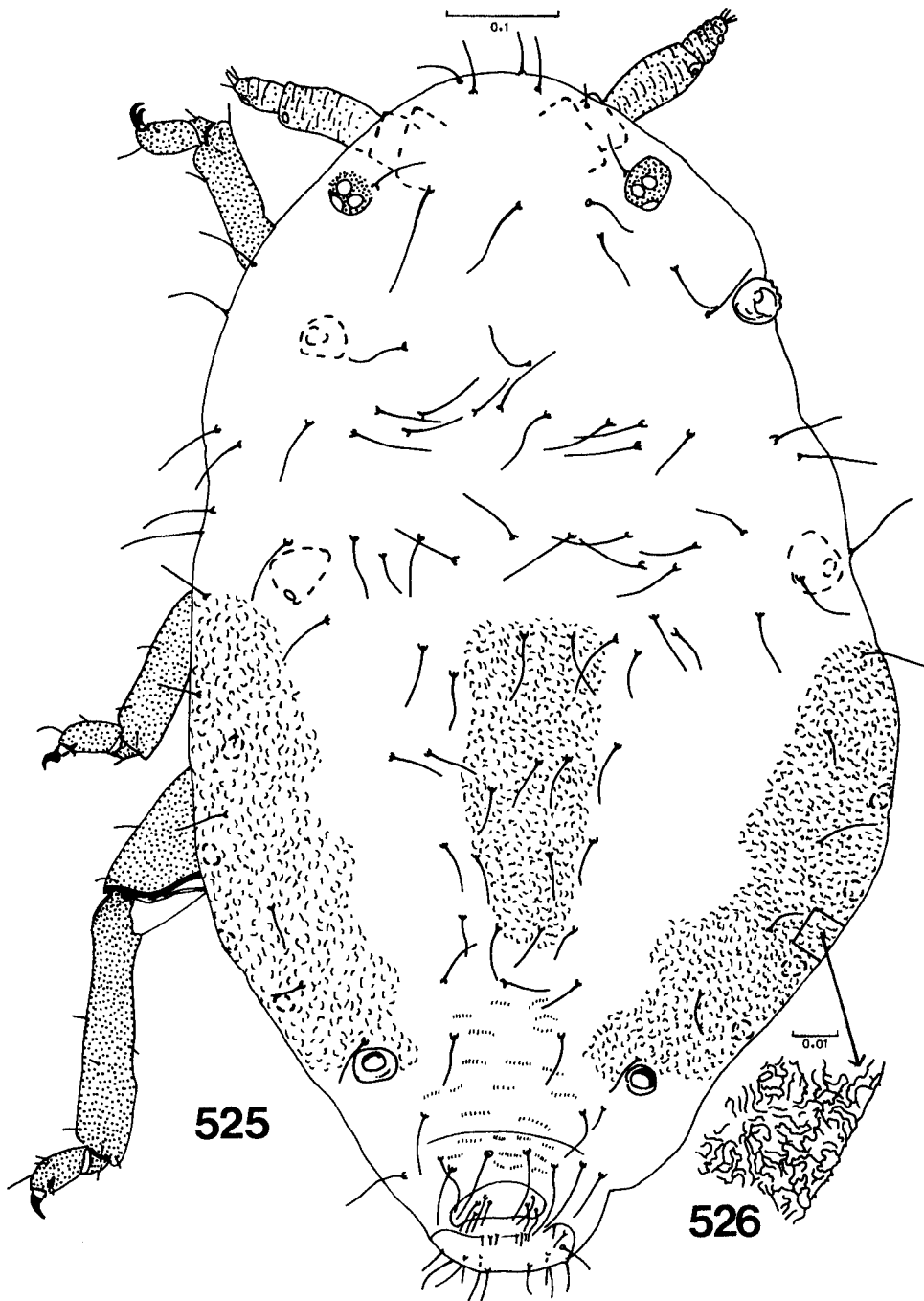

Fig. 522. *Reticulaphis distylii* (Van der Goot), third stage larva from leaf of *Ficus* (after a fourth stage developing to an alate), with hairs and button organs.



Figs. 523-524. *Reticulaphis distylis* (Van der Goot), button organs of fourth stage larva of alate viviparous ♀ from leaf of *Ficus*. Fig. 523, button organs on part of marginal sclerite of abdominal segments V-VI. Fig. 524, one button organ seen from the side, and a small one from above, on margin of abdominal segment II.





Figs. 525-526. *Schizoneuraphis gallarum* Van der Goot, apterous viviparous ♀ from gall No. 1 of *Distylium stellare*. Fig. 525, dorsal side of the body. Fig. 526, lines, somewhat as convolutions of the brain, marginally on abdominal segment IV.

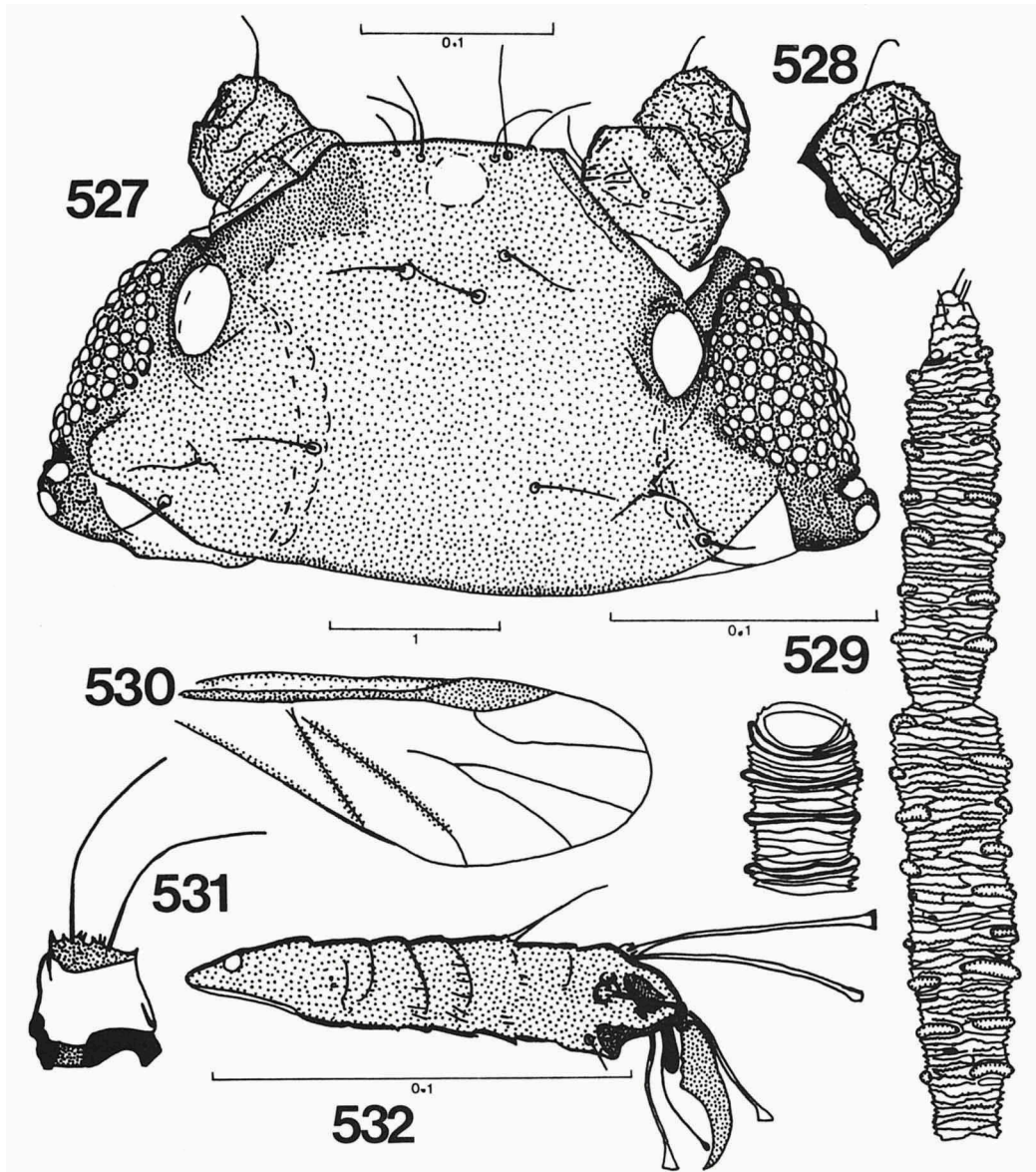

Figs. 527-532. *Schizoneuraphis gallarum* Van der Goot, alate viviparous ♀. Fig. 527, dorsal side of the head. Fig. 528, ventral side of antennal segment II. Fig. 529, ventral side of antennal segment IV (left), and dorsal sides of IV-V (right). Fig. 530 fore wing. Fig. 531, first tarsal segment of the foreleg. Fig. 532, second tarsal segment of the hind leg. Figs. 528-529 scale line to fig. 529. Scale line below to figs. 531-532.

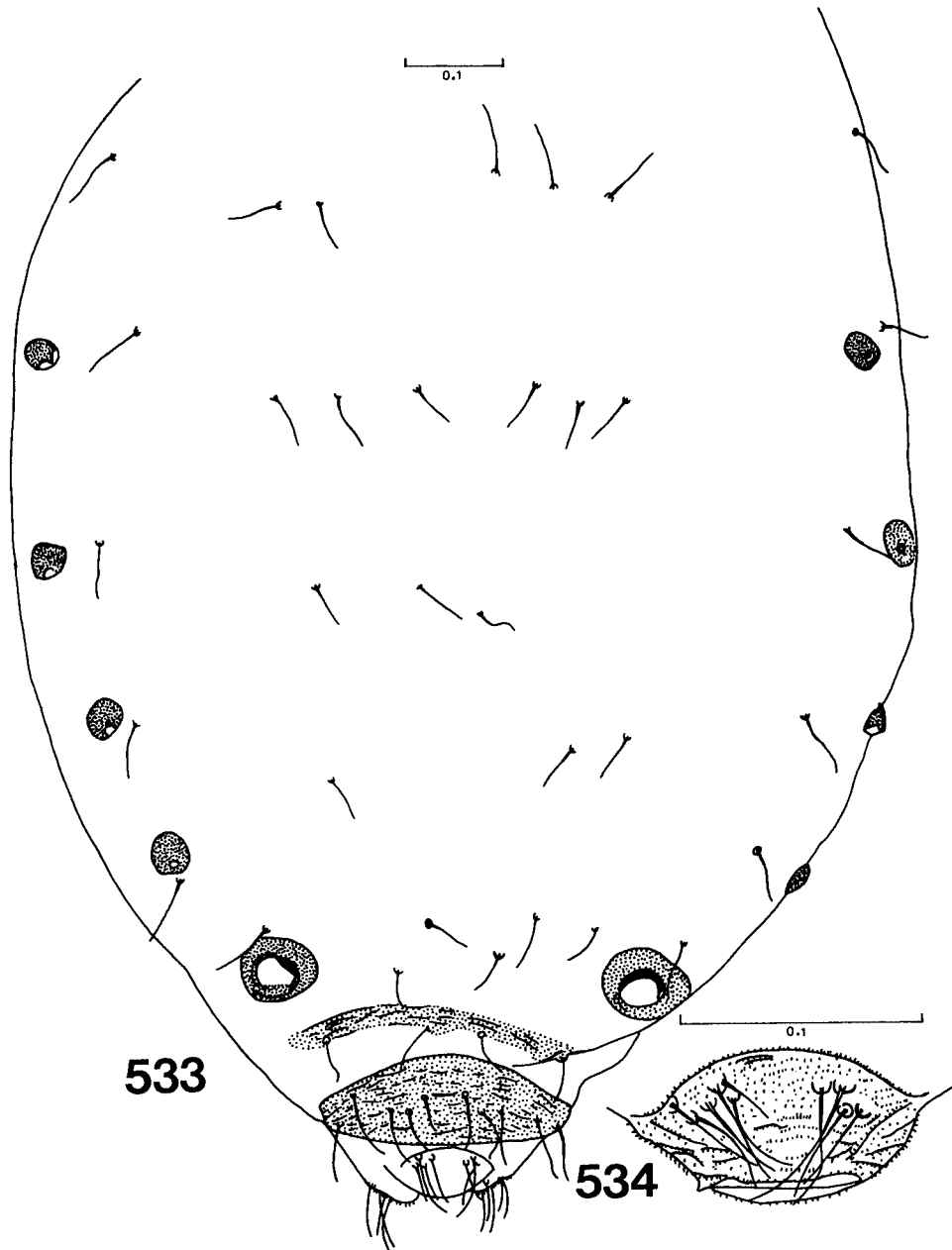

Figs. 533-534. *Schizoneuraphis gallarum* Van der Goot, alate viviparous ♀. Fig. 533, dorsal sides of abdominal segments I-VIII. Fig. 534, cauda.

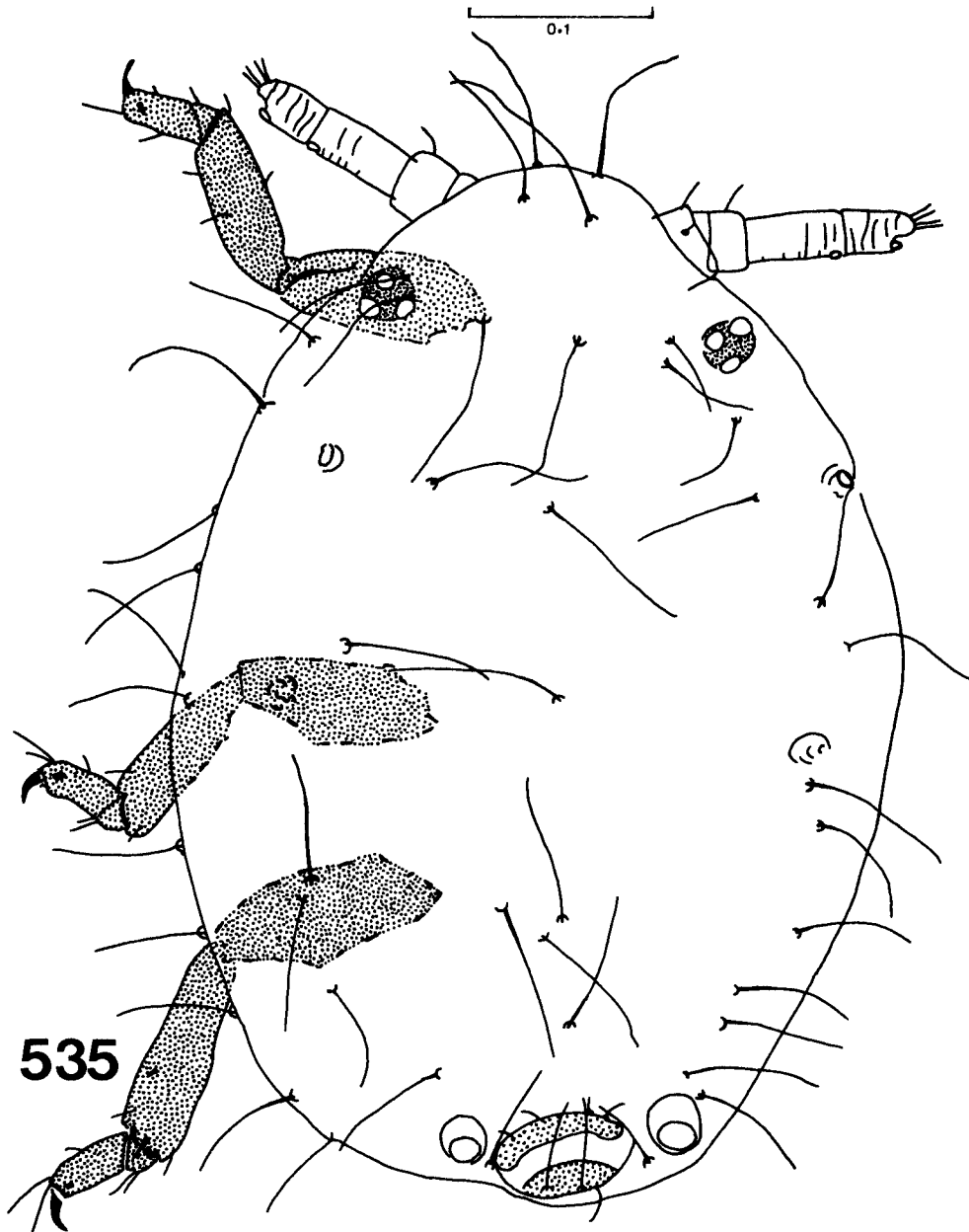

Fig. 535. *Schizoneuraphis gallarum* Van der Goot, first (presumably) stage larva from gall No. 1 of *Distylium stellare*, dorsal side of the body.

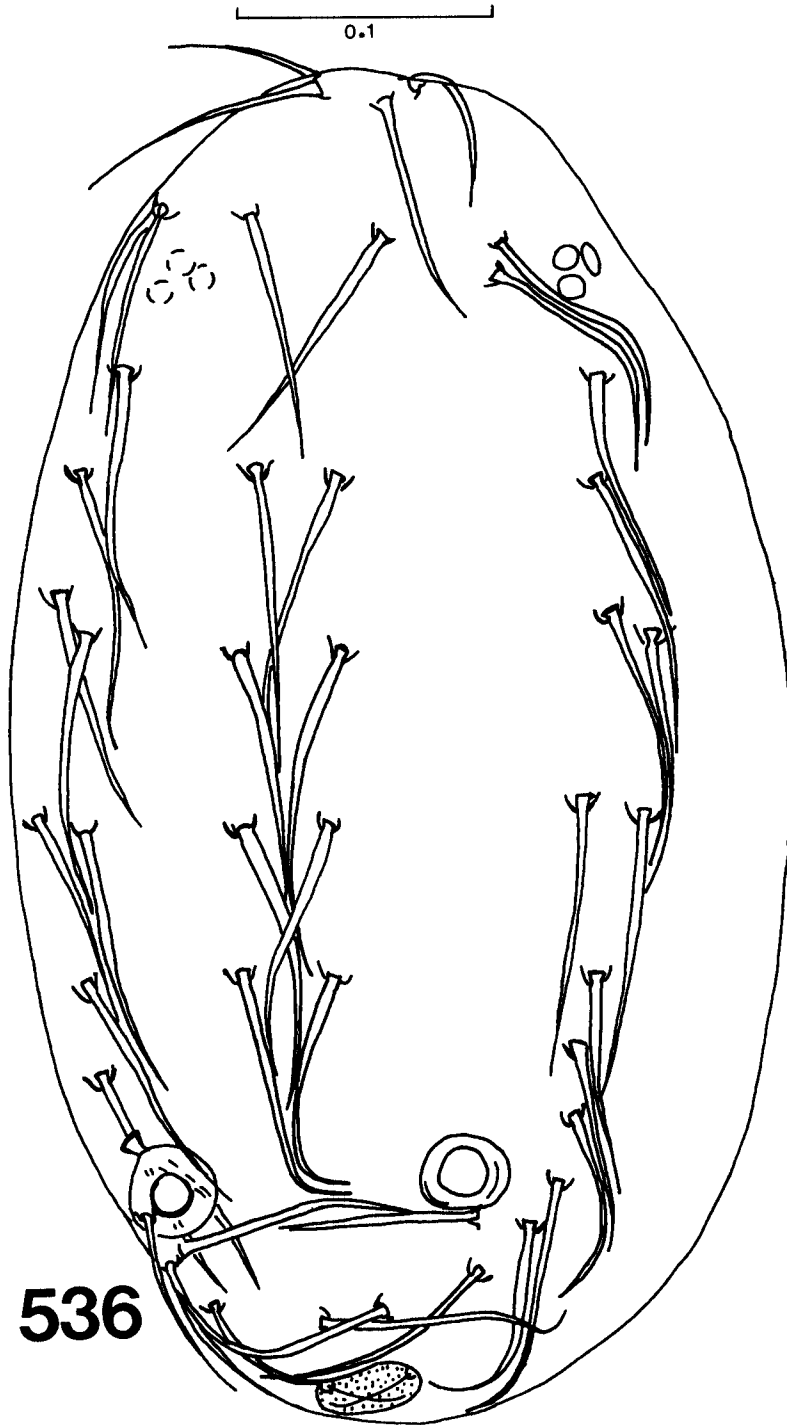
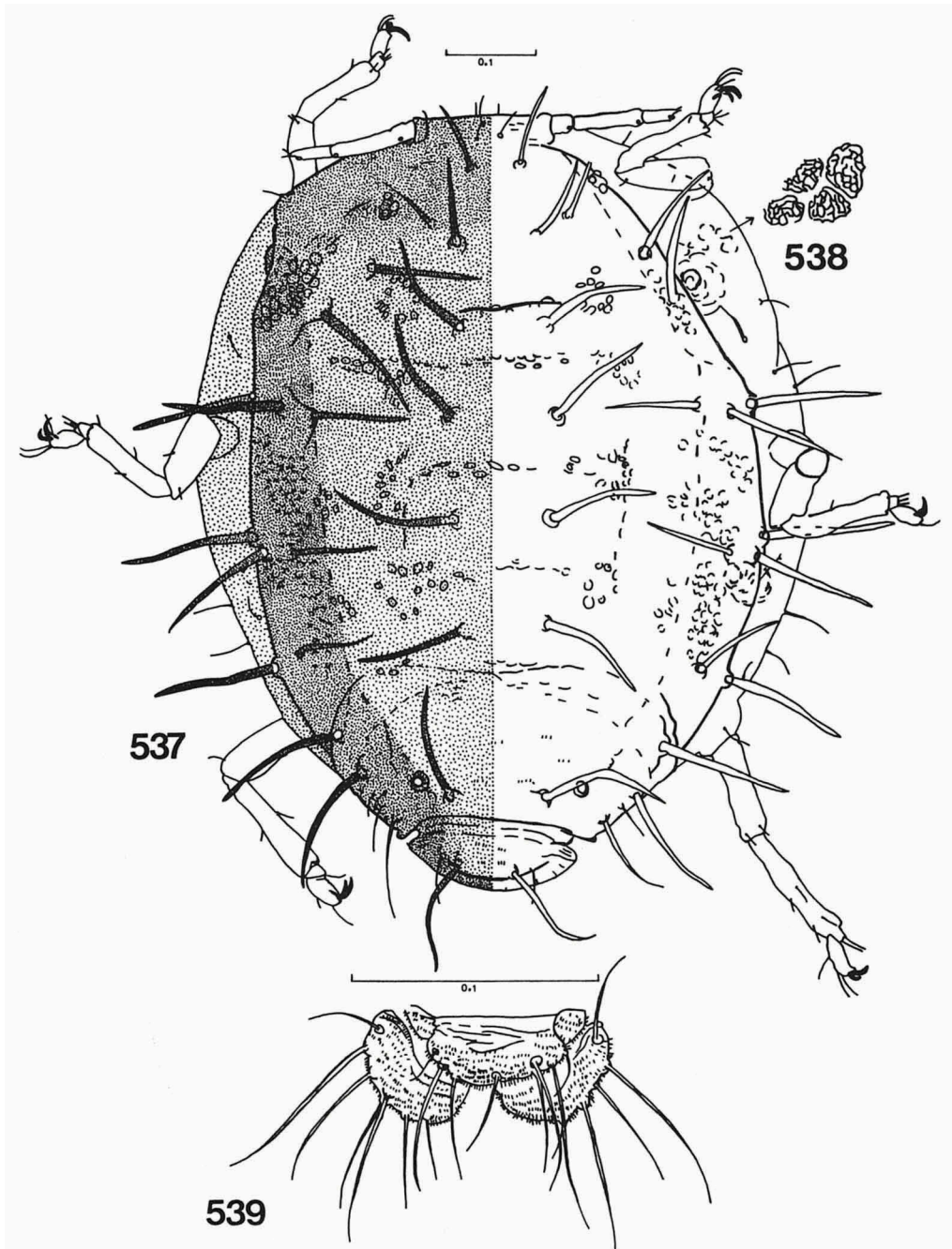
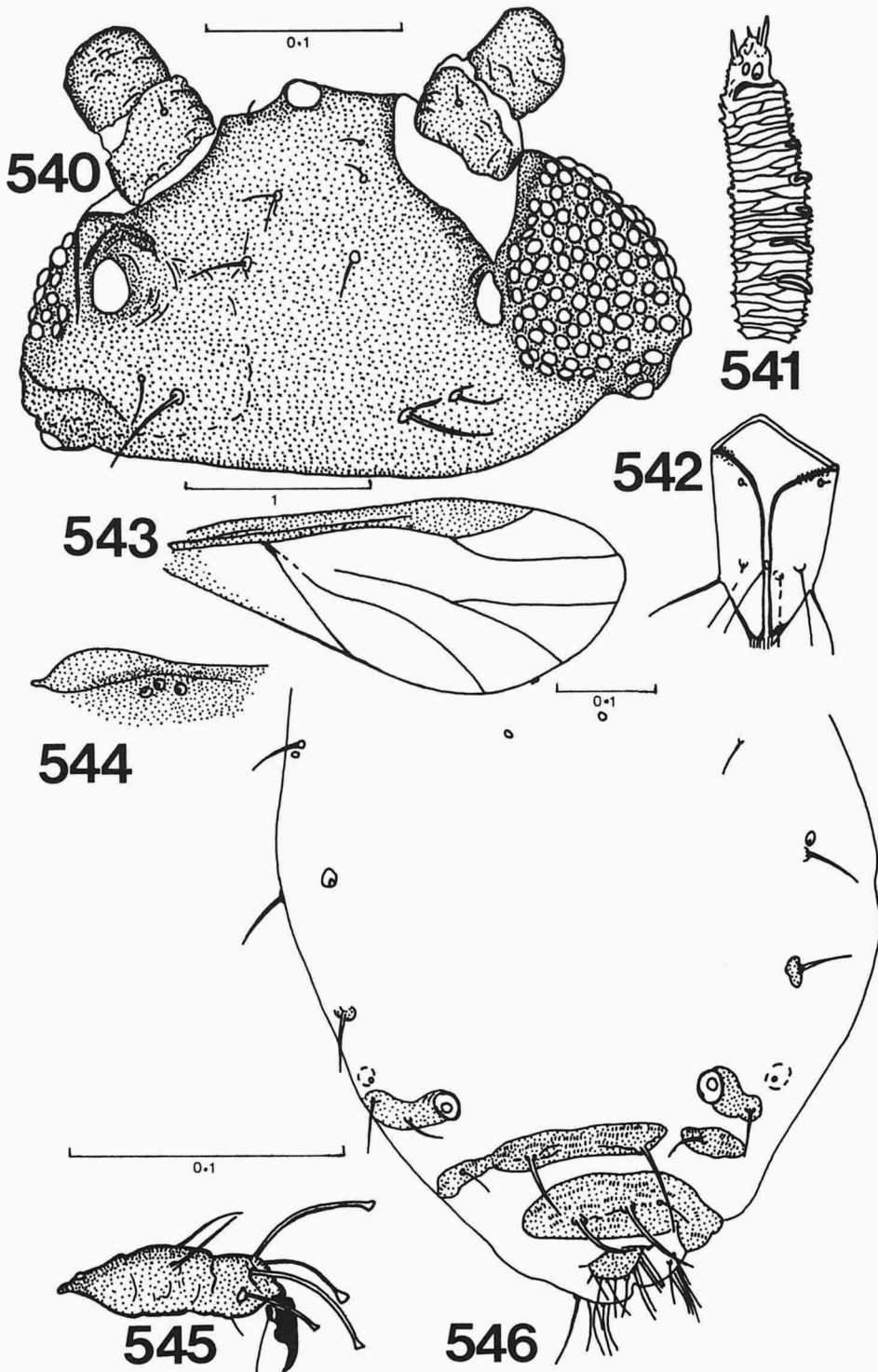

Fig. 536. *Schizoneuraphis gallarum* Van der Goot, embryo inside abdomen of alate viviparous ♀ from gall No. 1 of *Distylium stellare*, dorsal side of the body.



Figs. 537-539. *Schizoneuraphis gallarum* Van der Goot, apterous viviparous ♀ from leaf of *Litsea glutinosa*. Fig. 537, dorsal side of the body. Fig. 538, wax glands. Fig. 539, cauda and anal plate.



Figs. 540-546. *Schizoneuraphis gallarum* Van der Goot, alate viviparous ♀ from leaf of *Litsea glutinosa*. Fig. 540, dorsal side of the head. Fig. 541, dorsal side of antennal segment V. Fig. 542, ultimate rostral segment. Fig. 543, fore wing. Fig. 544, base of the fore wing. Fig. 545, second tarsal segment of the hind leg. Fig. 546, dorsal side of abdominal segments II-VIII.

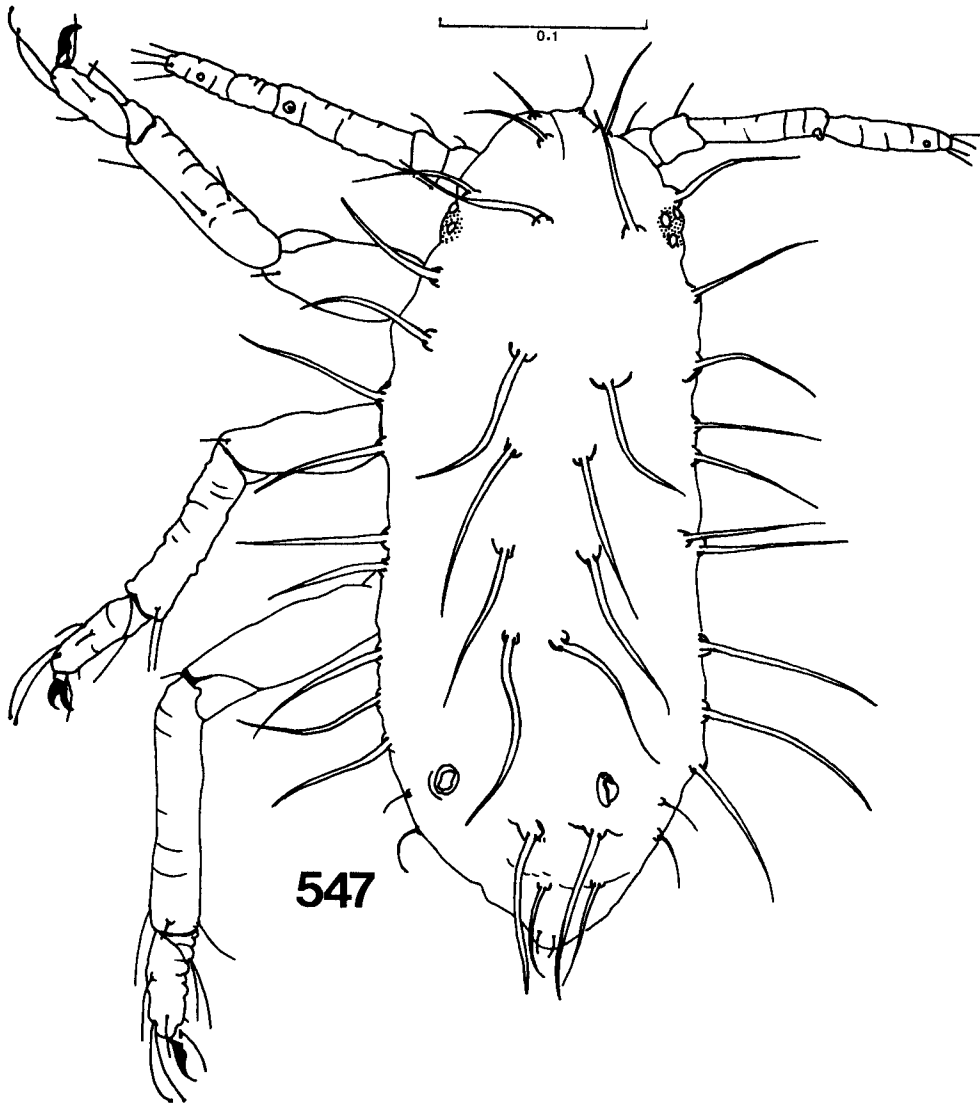

Fig. 547. *Schizoneuraphis gallarum* Van der Goot, first stage larva from leaf of *Litsea glutinosa*, dorsal side of the body.



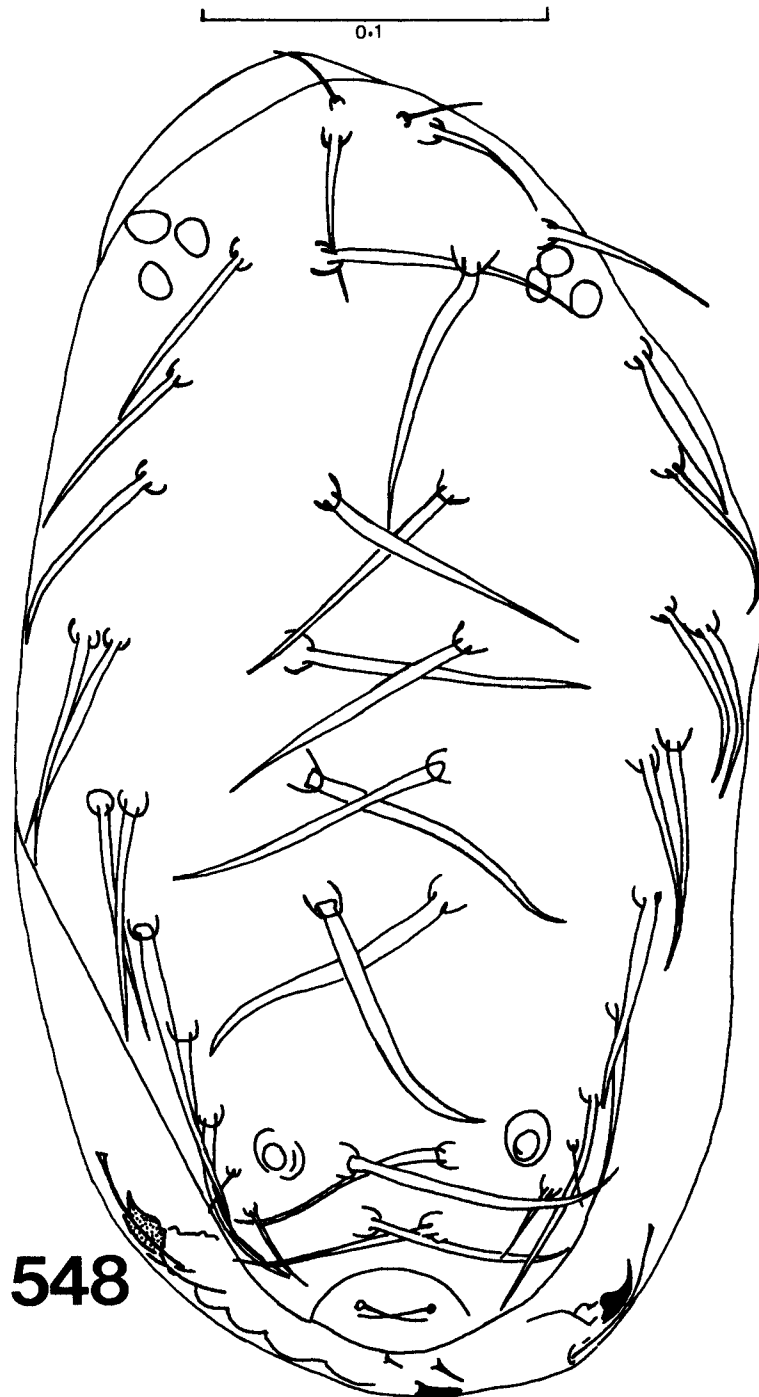

Fig. 548. *Schizoneuraphis gallarum* Van der Goot, embryo inside abdomen of alate viviparous ♀ from leaf of *Litsea glutinosa*, dorsal side of the body.

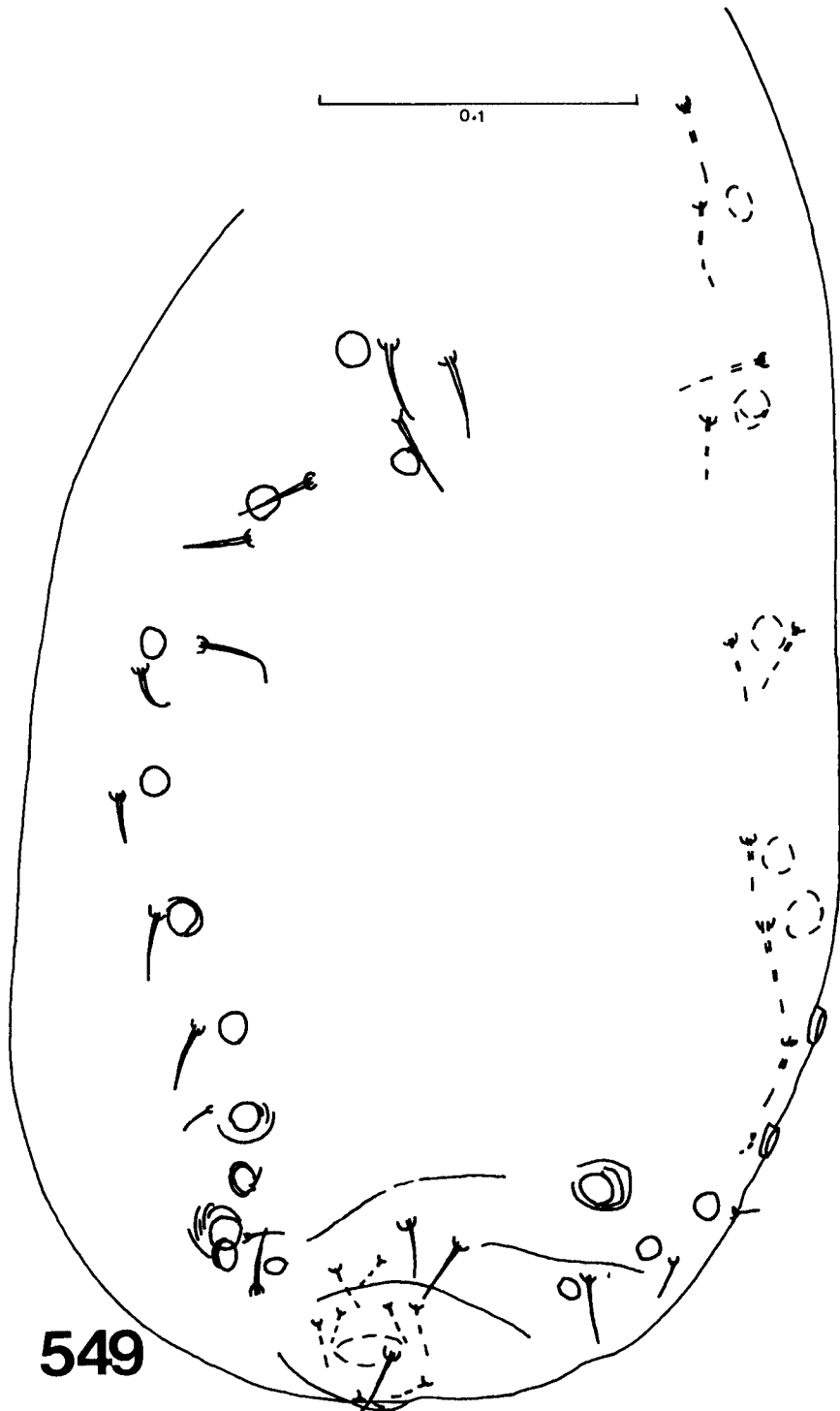

Fig. 549. *Schizoneuraphis gallarum* Van der Goot, embryo inside alate viviparous ♀ from leaf of *Litsea glutinosa*, embryo with short hairs and button organs.

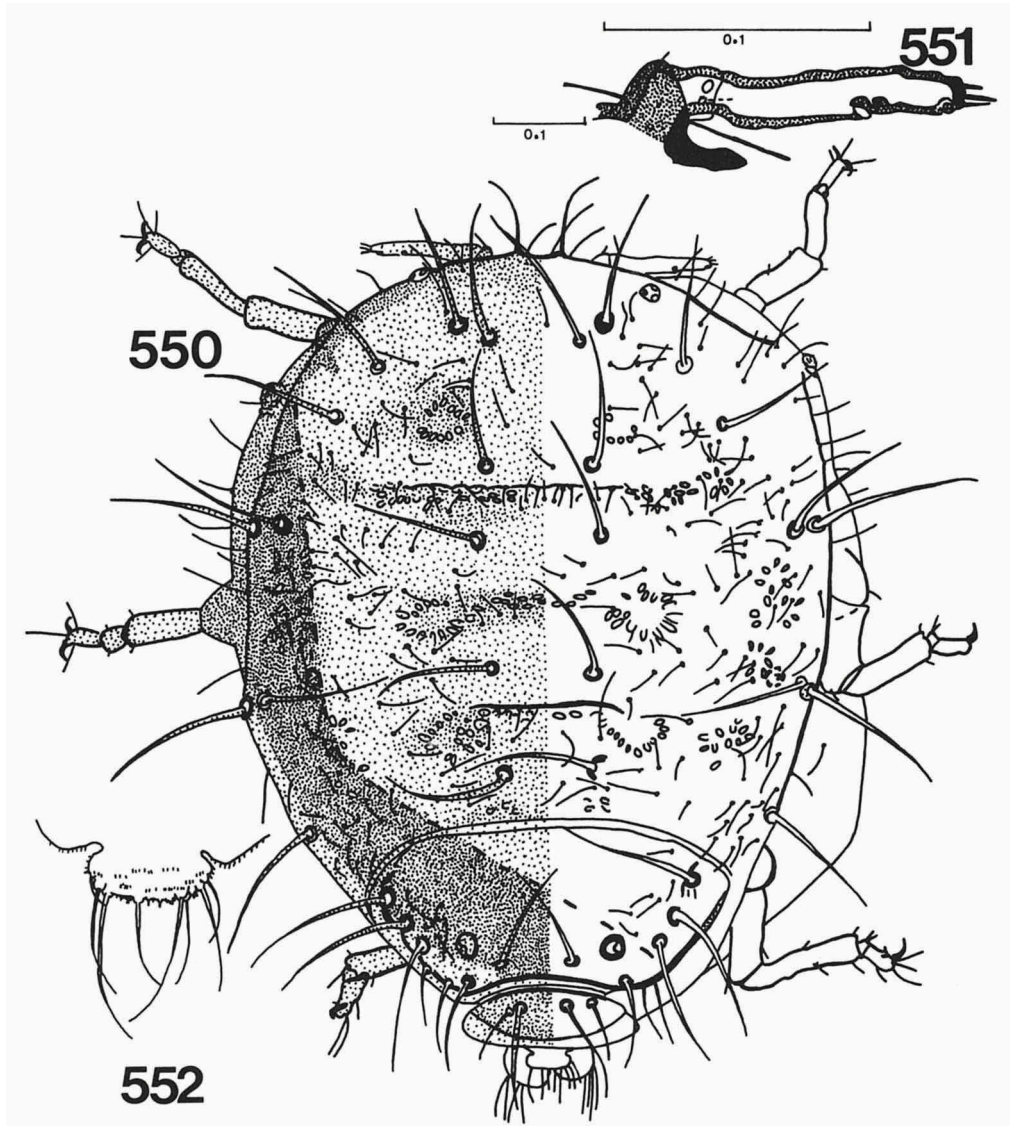

Fig. 550-552. *Schizoneuraphis litseicola* spec. nov., apterous viviparous ♀ from leaf of *Litsea amara*, dorsal side of the body. Fig. 551, antenna. Fig. 552, cauda.

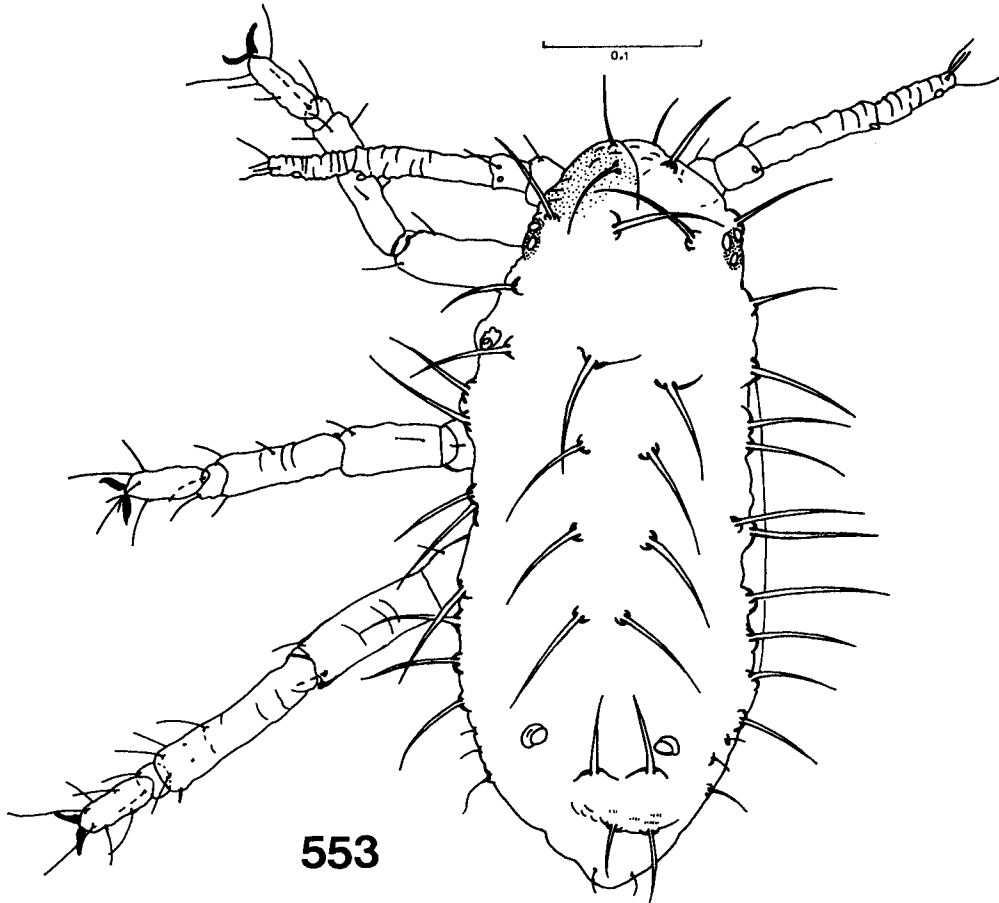
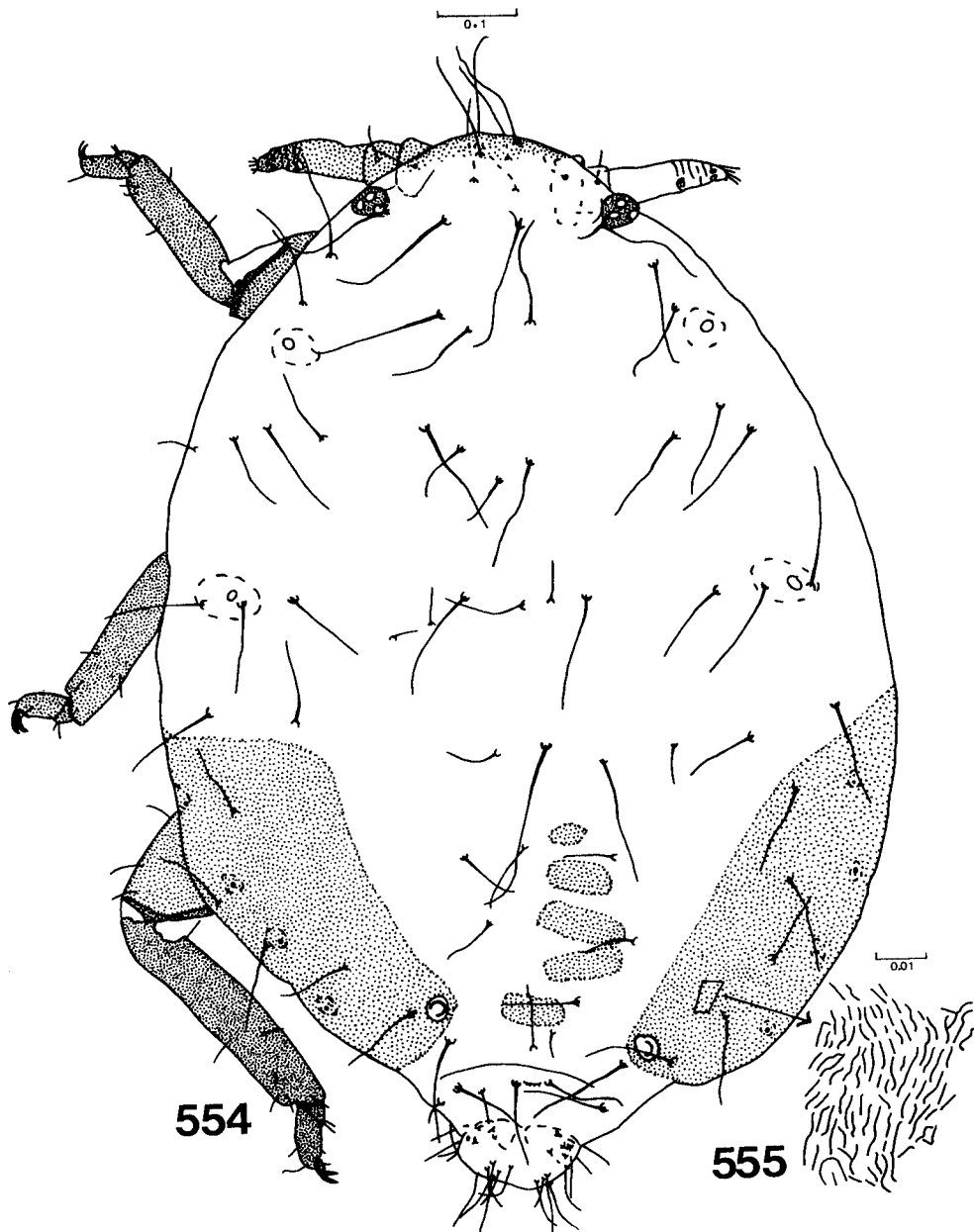
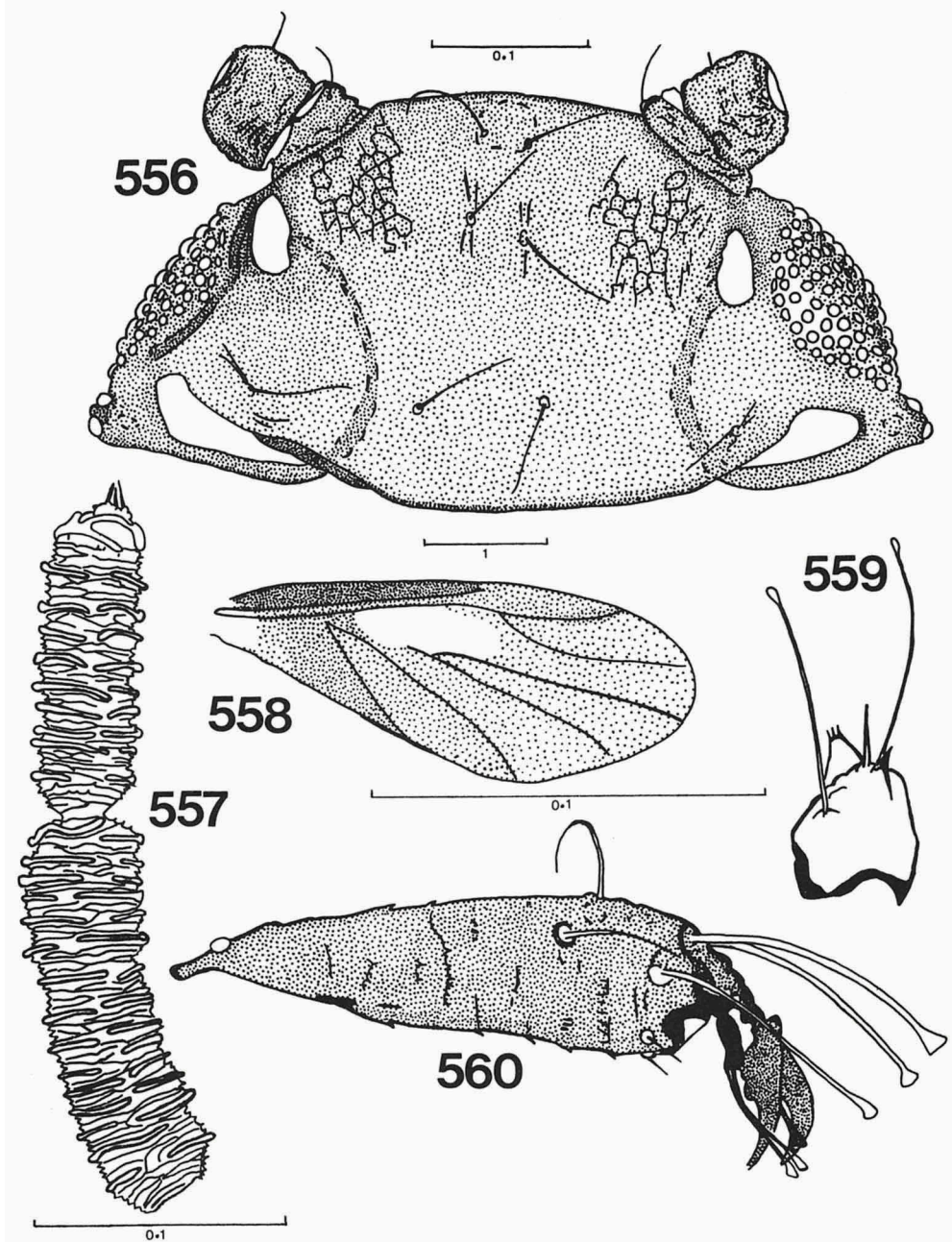

Fig. 553. *Schizoneuraphis litseicola* spec. nov., first stage larva from leaf of *Litsea amara*, dorsal side of the body.



Figs. 554-555. *Schizoneuraphis longisetosa* spec. nov., apterous viviparous ♀ from gall No. 2 of *Distylium stellare*. Fig. 554, dorsal side of the body, dotted areas on the abdomen indicate linear wax glands. Fig. 555, linear wax glands.



Figs. 556-560. *Schizoneuraphis longisetosa*. spec. nov., alate viviparous ♀ from gall No. 2 of *Distylium stellare*. Fig. 556, dorsal side of the body. Fig. 557, dorsal sides of antennal segments IV-V. Fig. 558, fore wing. Fig. 559, first tarsal segment of the foreleg. Fig. 560, second tarsal segment of the hind leg. The longest scale line to figs. 559-560.

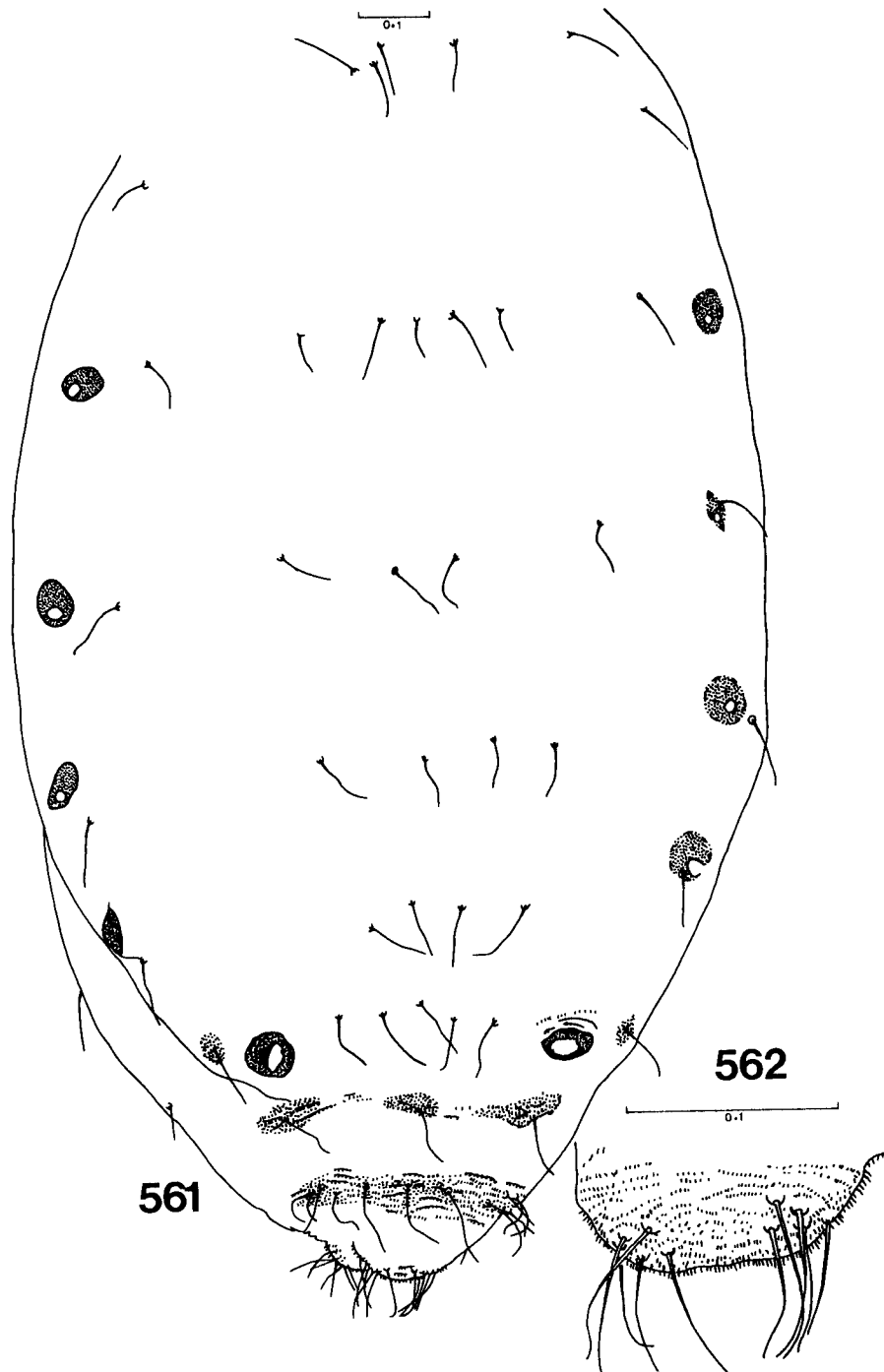

Figs. 561-562. *Schizoneuraphis longisetosa* spec. nov., alate viviparous ♀ from gall No. 2 of *Distylium stellare*. Fig. 561, dorsal sides of the abdominal segments I-VIII. Fig. 562, cauda.

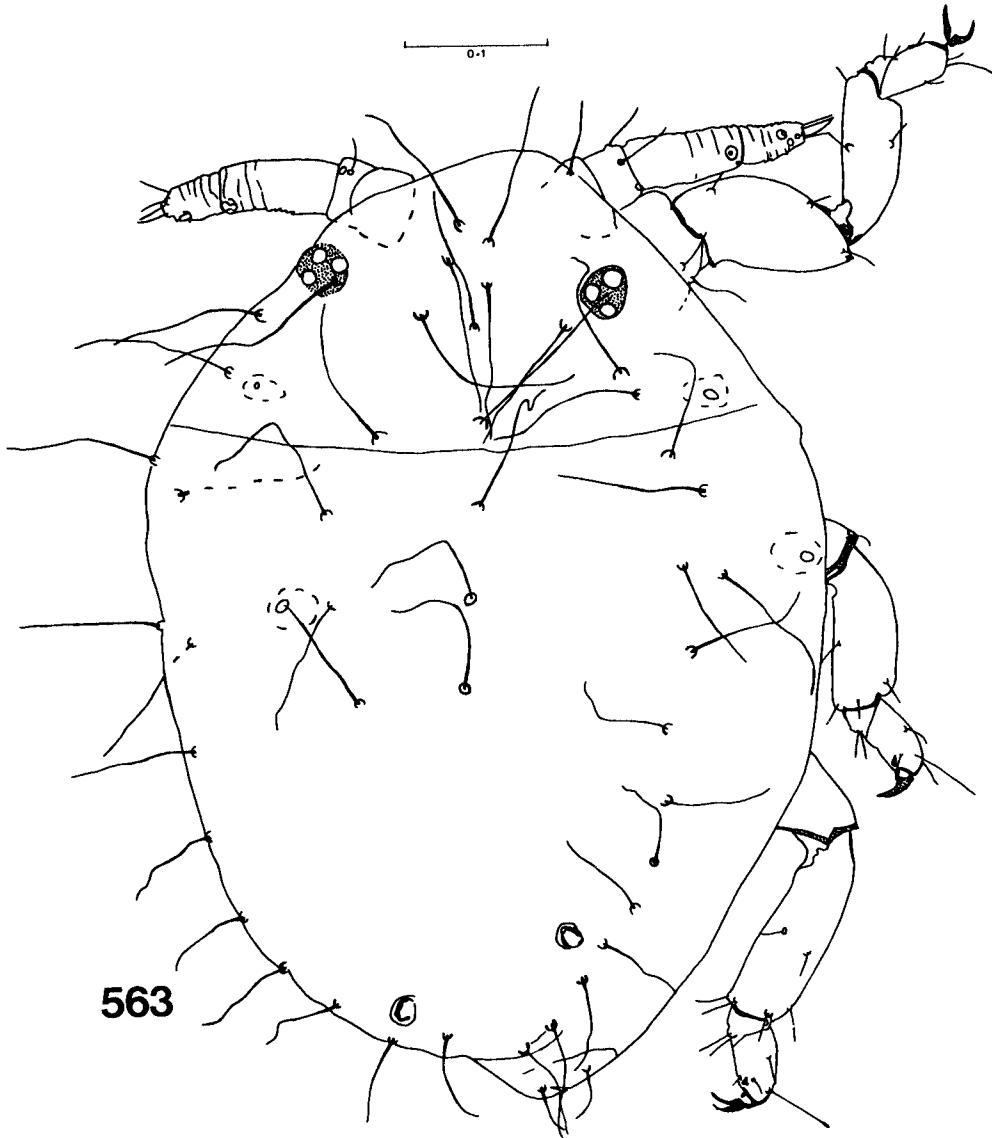
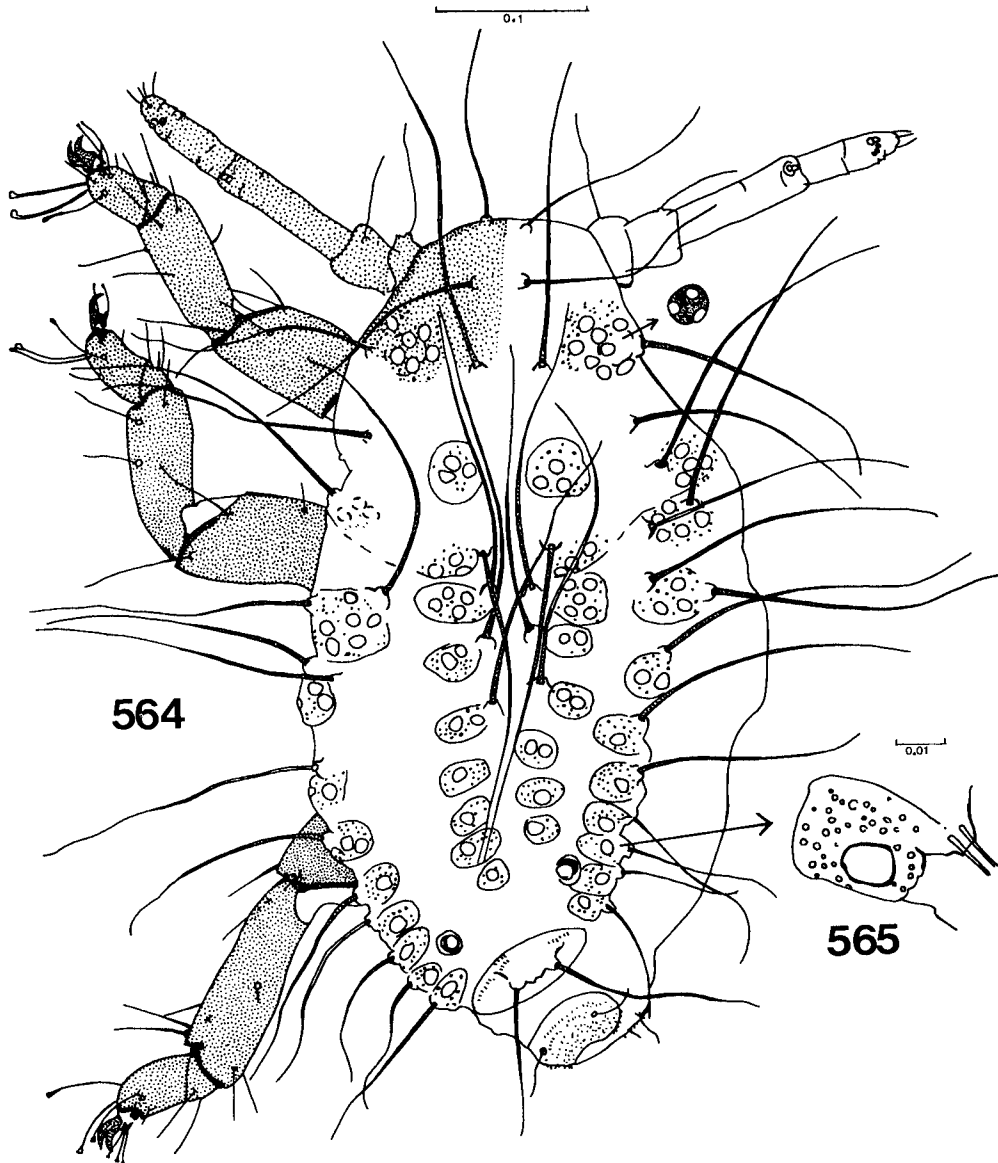

Fig. 563. *Schizoneuraphis longisetosa* spec. nov., first stage larva from gall No. 2 of *Distylium stellare*, dorsal side of the body.





Figs. 564-565. *Schizoneuraphis longisetosa* spec. nov., embryo, first stage larva from inside the abdomen of an alate viviparous ♀ from gall No. 2 of *Distylium stellare*. Fig. 564, dorsal side of the body. Fig. 565, marginal part of abdominal segment V with one pustule.

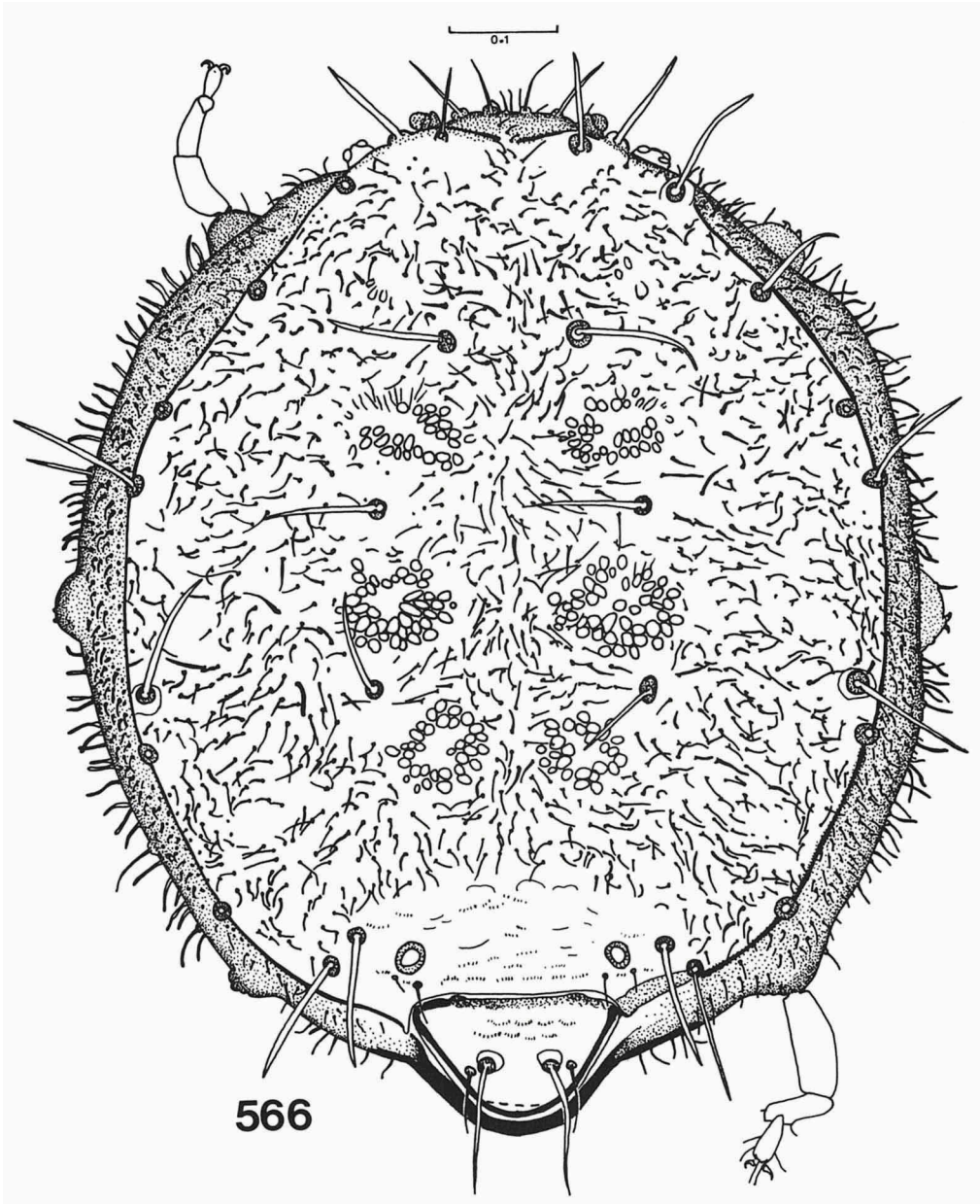
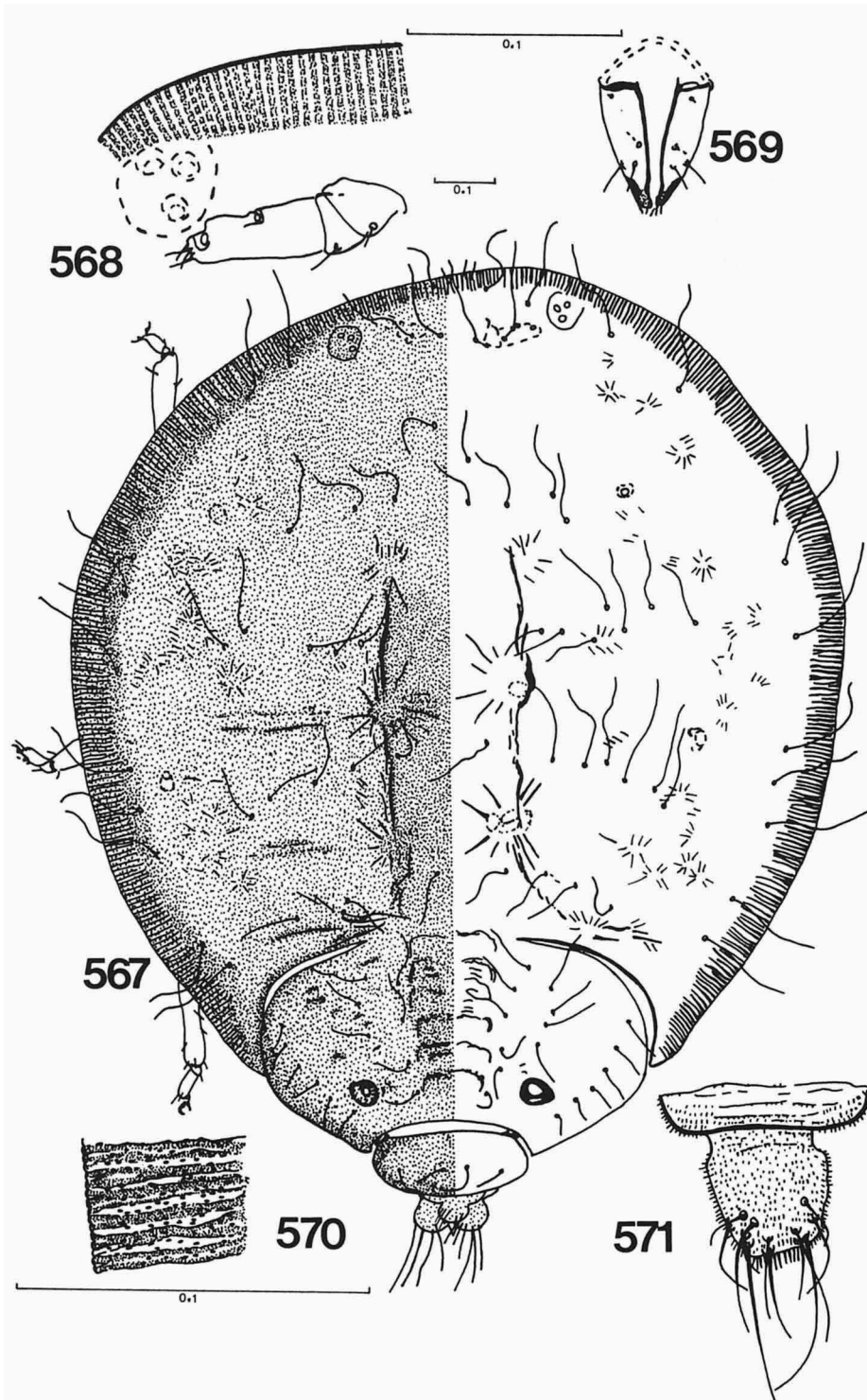
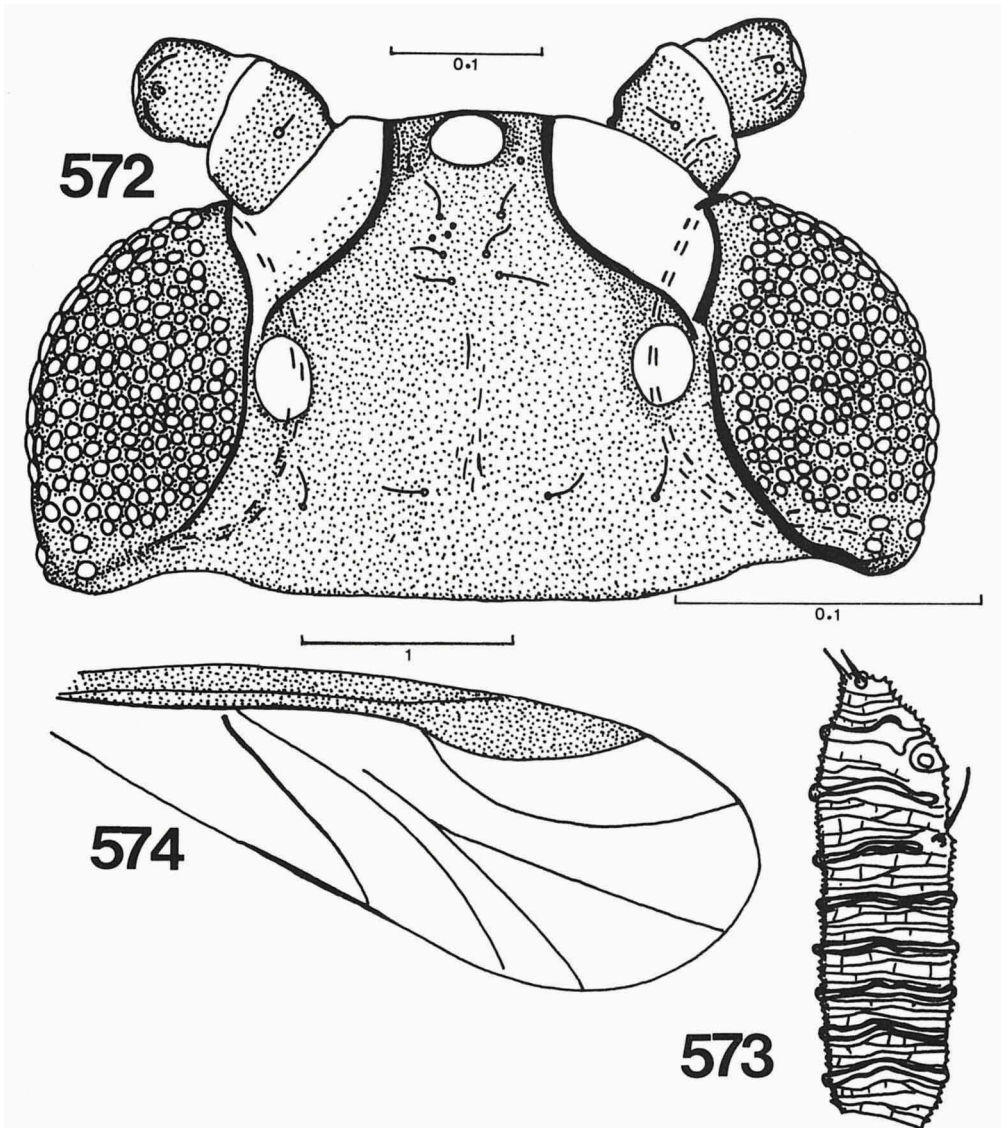

Fig. 566. *Sinonipponaphis hispida* spec. nov., apterous viviparous ♀, dorsal side of the body.



Figs. 567-571. *Thoracaphis arboris* Van der Goot, apterous viviparous ♀. Fig. 567, dorsal side of the body. Fig. 568, anterior part of the head, ventrally, with an antenna. Fig. 569, ultimate rostral segment. Fig. 570, part of the striped margin of the prosoma. Fig. 571, cauda.



Figs. 572-574. *Thoracaphis arboris* Van der Goot, alate viviparous ♀. Fig. 572, dorsal side of the head. Fig. 573, ventral side of antennal segment V. Fig. 574, fore wing.

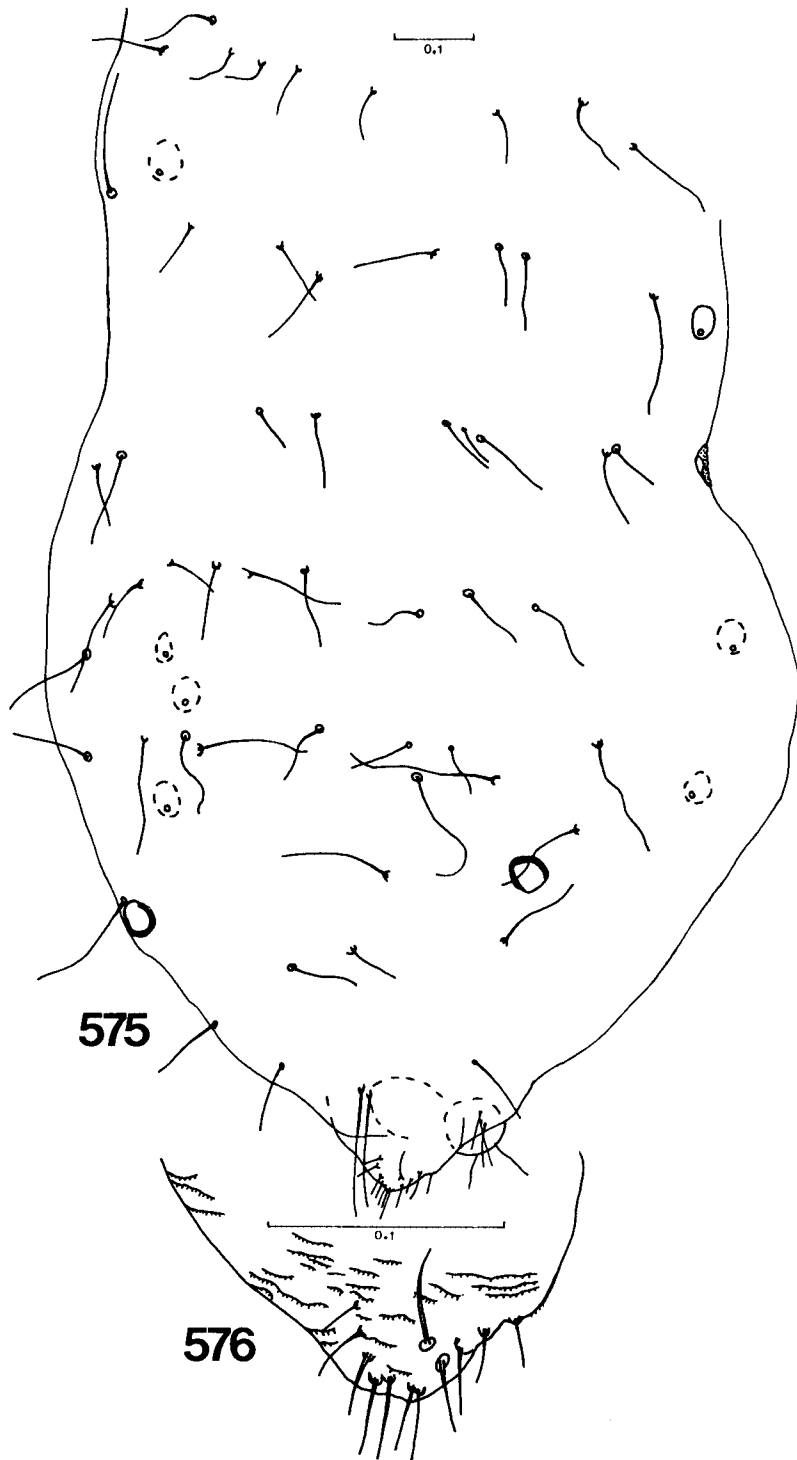

Figs. 575-576. *Thoracaphis arboris* Van der Goot, alate viviparous ♀. Fig. 575, dorsal sides of abdominal segments I-VIII. Fig. 576, cauda.

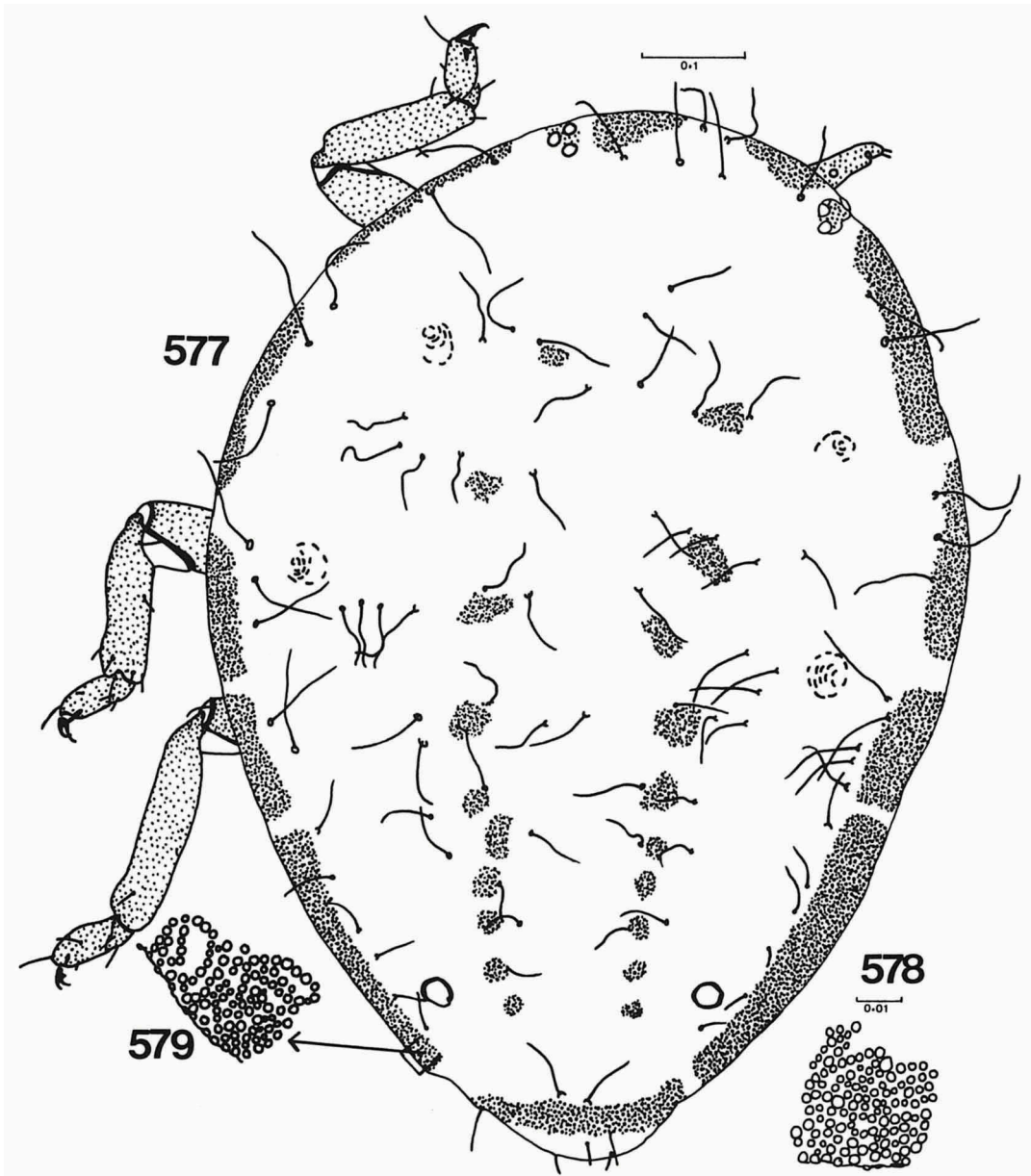

Figs. 577-579. *Thoracaphis arboris* Van der Goot, last stage larva of apterous viviparous ♀. Fig. 577, dorsal side of the body, dots on the body indicate areas with circular wax glands. Fig. 578, circular wax glands on the posterior margin of the abdomen, ventrally. Fig. 579, circular wax glands dorsally. Scale line below to figs. 578-579.

## Index

- albostrata*, *Pseudoregma* ..... 206  
*Aleurocanthus* ..... 119  
*Aleurocanthus palmae* ..... 119  
*Aleurodaphis* ..... 21, 24, 46  
*Aleurodaphis blumeae* ..... 34, 42, 46, 47  
*Alpinia* ..... 30, 31, 71, 231  
*Alpinia schumanniana* ..... 231  
*Amomum* ..... 30  
*Amomum coccineum* ..... 71  
*Amomum gracile* ..... 231  
*Aphis* ..... 46, 281  
*Aphis palmae* ..... 113  
Araceae ..... 104, 127  
*arboris*, *Thoracaphis* ..... 25, 36, 42, 279, 281, 285  
*Areca* ..... 119, 123  
*Areca cathecu* ..... 119, 123  
*Arenga* ..... 123  
*Arenga pinnata* ..... 123  
*Astegopteryx* ..... 5, 6, 21, 22, 24, 50, 52, 53, 59, 205, ..... 232  
*Astegopteryx bambusae* ..... 28, 41, 52, 53, 54, 59, 66, ..... 100, 102  
*Astegopteryx basalis* ..... 28, 39, 52, 53, 59, 62  
*Astegopteryx fici* ..... 250  
*Astegopteryx formosana* ..... 277  
*Astegopteryx fransseni* ..... 96, 105  
*Astegopteryx glandulosa* ..... 28, 40, 52, 63, 65  
*Astegopteryx javensis* ..... 250  
*Astegopteryx lutescens*, col. var. *A. bambusae* ..... 28, ..... 58  
*Astegopteryx maculata*, col var. *A. bambusae* ..... 28, ..... 54, 58  
*Astegopteryx minuta* ..... 27, 41, 52, 59, 66, 68  
*Astegopteryx muiri* ..... 30, 41, 52, 68, 71, 81, 82  
*Astegopteryx nipae* ..... 29, 41, 52, 53, 68, 72, 82, 87  
*Astegopteryx pallida* ... 28, 41, 52, 53, 59, 75, 76, 80, ..... 94, 96  
*Astegopteryx pandani* ..... 29, 52, 81, 82  
*Astegopteryx rappardi* ..... 29, 40, 41, 51, 52, 82, 85, ..... 87, 97  
*Astegopteryx rhapsidis* ..... 29, 40, 41, 52, 53, 86, 90  
*Astegopteryx salatigensis* ..... 76, 80  
*Astegopteryx setigera* ..... 5, 32, 38, 50, 90, 94  
*Astegopteryx similis*, col. var. *A. bambusae* ..... 58  
*Astegopteryx singaporensis* ..... 29, 94, 96  
*Astegopteryx striata*, col. var. *A. bambusae* ..... 28, 58  
*Astegopteryx styracophila* ..... 5, 32, 40, 50, 90, 96, ..... 97, 99  
*Astegopteryx unimaculata* ... 27, 41, 54, 59, 99, 100, ..... 102  
*Asterolecanium* ..... 116  
*Asterolecanium orchidearum* ..... 116  
bamboo 5, 27, 28, 29, 30, 31, 32, 39, 50, 51, 53, 54, 57, 58, 59, 60, 62, 63, 65, 66, 68, 75, 80, 96, 102, 129, 132, 136, 141, 144, 146, 165, 167, 168, 210, 211, ..... 215  
*Bambusa* ..... 59, 102, 132, 168, 211  
*Bambusa arundinacea* ..... 80, 168, 210  
*Bambusa arundinaria* ..... 53  
*Bambusa blumeana* ..... 27, 58, 59, 68, 80, 102  
*Bambusa glaucescens* ..... 58, 165, 167, 168  
*Bambusa schyzostachyoides* ..... 96, 168, 226  
*Bambusa vulgaris* ..... 58, 59  
Bambusaceae ..... 34  
*bambusae*, *Astegopteryx* ... 28, 41, 52, 53, 54, 59, 66, ..... 100, 102  
*bambusae*, *Ceratoglyphina* ..... 27, 38, 127, 129, 132, ..... 133, 136  
*bambusae*, *Glyphinaphis* ... 6, 34, 42, 164, 165, 168  
*bambusae*, *Oregma* ..... 53, 205, 206  
*bambusicola*, *Oregma* ..... 203, 206  
*bambusicola*, *Pseudoregma* ..... 32, 40, 204, 206, 211, ..... 225  
*basalis*, *Astegopteryx* ..... 28, 39, 52, 53, 59, 62  
*basalis*, *Oregma* ..... 59, 60  
*bengalensis*, *Ceratoglyphina* .. 27, 38, 127, 133, 136  
*blumeae*, *Aleurodaphis* ..... 34, 46, 47, 50  
*Blumea* ..... 34, 42, 47, 49, 50  
*brevipilosa*, *Nipponaphis* .. 37, 38, 43, 187, 188, 193, ..... 198  
*Calamus* ..... 75  
*Calamus unifarius* ..... 75  
*calva*, *Neohormaphis* ..... 5, 25, 34, 36, 42, 179, 180, ..... 181  
*Castanea* ..... 188, 192  
*Castanopsis* ..... 23, 192, 249  
*Castanopsis acuminatissima* ..... 37, 44, 194, 198  
*Castanopsis argentea* ..... 37, 43, 188, 198  
*Castanopsis javanica* ..... 38, 198, 201  
*Catimbium* ..... 31, 231  
*Catimbium malaccensis* ..... 231  
*Cerataphis* ..... 6, 21, 25, 103, 105, 109, 127  
*Cerataphis fransseni* ..... 5, 25, 32, 45, 105, 109, 124  
*Cerataphis freycinetiae* ..... 35, 45, 109, 113, 127  
*Cerataphis insularis* ..... 53, 54, 100  
*Cerataphis latanaeae* ..... 119  
*Cerataphis lataniae* ..... 35, 46, 113, 116, 119, 127  
*Cerataphis minutus* ..... 66  
*Cerataphis nipae* ..... 72  
*Cerataphis orchidearum* ..... 35, 46, 116  
*Cerataphis pallidus* ..... 75, 80  
*Cerataphis palmae* ... 35, 45, 108, 109, 110, 119, 124, ..... 127  
*Cerataphis pothophila* ..... 35, 45, 124, 127  
*Cerataphis variabilis* ..... 119  
*Ceratoglyphina* ..... 21, 24, 127, 128, 232  
*Ceratoglyphina bambusae* ..... 27, 38, 127, 129, 132, ..... 133, 136  
*Ceratoglyphina bengalensis* ... 27, 38, 127, 133, 136  
*Ceratoglyphina nigra* ..... 246  
*Ceratovacuna* ..... 5, 22, 24, 136, 232  
*Ceratovacuna floccifera* ..... 30, 39, 137, 138, 141

<i>Ceratovacuna graminum</i> .....	30, 136, 137, 141, 142, 144	<i>Ficus depressa</i> .....	259
<i>Ceratovacuna keduensis</i> .....	30, 39, 137, 144, 146	<i>Ficus drupacea</i> .....	259
<i>Ceratovacuna lanigera</i> .....	31, 39, 136, 146, 150	<i>Ficus pruniformis</i> .....	253, 255, 259
<i>Ceratovacuna longifila</i> .....	141	<i>Ficus septica</i> .....	259
<i>Ceratovacuna orientalis</i> .....	142	<i>flava</i> , <i>Trichoregma</i> .....	59, 60, 62
<i>Ceratovacuna panici</i> .....	31, 39, 137, 150, 153	<i>floccifera</i> , <i>Ceratovacuna</i> .....	30, 39, 137, 138, 141
<i>cerina</i> , <i>Rappardiella</i> .....	33, 232, 233, 235	<i>floccifera</i> , <i>Oregma</i> .....	138
<i>Cinnamomum</i> .....	23, 26, 43	<i>foliorum</i> , <i>Distylaphis</i> ..	5, 25, 33, 42, 155, 162, 259, 262
<i>Cinnamomum iners</i> .....	36, 164	<i>foliorum</i> , <i>Schizoneuraphis</i> .....	154, 155, 259
<i>Cinnamomum verum</i> .....	36, 164	<i>formosana</i> , <i>Astegopteryx</i> .....	277
<i>Cinnamomum zeylanicum</i> .....	164	<i>fransseni</i> , <i>Astegopteryx</i> .....	96, 105
Coccinellidae .....	211	<i>fransseni</i> , <i>Cerataphis</i> ....	5, 25, 32, 45, 105, 109, 124
Coccus .....	103	<i>Freycinetia</i> .....	29, 35, 45, 81, 82, 110, 113
<i>Coccus lataniae</i> .....	103, 113	<i>Freycinetia funicularis</i> .....	113
Cocos .....	29, 45	<i>Freycinetia gaudichaudii</i> .....	113
<i>Cocos nucifera</i> ..	35, 45, 46, 75, 82, 85, 89, 119, 123	<i>Freycinetia javanica</i> .....	81, 82
Costaceae .....	31	<i>freycinetiae</i> , <i>Cerataphis</i> ..	35, 45, 104, 109, 113, 127
<i>Costus</i> .....	31, 231	<i>gallarum</i> , <i>Schizoneuraphis</i> ....	5, 26, 34, 36, 44, 259, 260, 262, 263, 270, 271
<i>Costus afer</i> .....	231	galls, <i>Astegopteryx setigera</i> .....	90, 94
<i>Costus mexicanus</i> .....	231	galls, <i>Astegopteryx styracophila</i> .....	90, 96, 99
<i>Curculigo capitulata</i> .....	226, 231	galls, <i>Distylaphis foliorum</i> .....	155, 162
<i>Cyrtococcus</i> .....	31, 39	galls, <i>Neohormaphis calva</i> .....	181, 186
<i>Cyrtococcus accrescens</i> .....	222, 223	galls, <i>Rappardiella cerina</i> .....	235
<i>Daemonorops</i> .....	75	galls, <i>Rappardiella macrosoleni</i> .....	242
<i>Daemonorops geniculata</i> .....	75	galls, <i>Rappardiella plicator</i> .....	245
<i>Dendrobium</i> .....	119	galls, <i>Reticulaphis distylii</i> .....	250, 259
<i>Dendrocalamus asper</i> .....	62, 68, 80, 168	galls, <i>Schizoneuraphis gallarum</i> .....	262, 270
<i>Dendrocalamus giganteus</i> .....	96, 210	galls, <i>Schizoneuraphis longisetosa</i> .....	273, 276
<i>Dendrophthoë</i> .....	173	<i>Gigantochloa</i> .....	58, 102
<i>Dendrophthoë pentandra</i> ...	26, 33, 37, 44, 173, 233, 235	<i>Gigantochloa apus</i> .....	58, 68, 80, 132, 210
<i>distychiei</i> , <i>Nipponaphis</i> .....	186	<i>glandulosa</i> , <i>Astegopteryx</i> .....	28, 40, 52, 63, 65
<i>Distylaphis</i> .....	5, 23, 154, 155, 259	<i>Glyphinaphis</i> .....	21, 24, 164, 165
<i>Distylaphis foliorum</i> ....	5, 25, 34, 42, 155, 162, 259, 262	<i>Glyphinaphis bambusae</i> .....	6, 34, 42, 164, 165
<i>distylii</i> , <i>Reticulaphis</i> ....	5, 22, 34, 35, 185, 186, 249, 250, 269	Gramineae .....	51, 205
<i>distylii</i> , subsp. <i>rotifera</i> , <i>Reticulaphis</i> .....	250, 253, 257	<i>graminum</i> , <i>Ceratovacuna</i> ....	30, 136, 137, 141, 142, 144
<i>distylii</i> , <i>Schizoneuraphis</i> .....	250, 259	<i>graminum</i> , <i>Oregma</i> .....	141
<i>Distylium</i> .....	21, 155, 180, 181, 259, 269, 270, 273	<i>graminum</i> , <i>Pseudoregma</i> .....	141
<i>Distylium stellare</i> .....	5, 25, 26, 34, 42, 43, 44, 154, 155, 156, 158, 160, 161, 162, 179, 181, 186, 249, 250, 253, 254, 258, 259, 262, 263, 265, 269, 270, 273, 276	grasses .....	30, 31, 39, 144, 222
<i>Distylium racemosum</i> .....	250	<i>Hedychium</i> .....	30, 31
<i>djalaprang</i> .....	279	<i>Hedychium coccineum</i> .....	218
<i>Elaeis</i> .....	75	<i>Hedychium coronarium</i> .....	71
<i>Elaeis guineensis</i> .....	75	<i>heterotricha</i> , <i>Euthoracaphis</i> .....	26, 36, 43, 162, 163, 164
<i>Elettaria</i> .....	31	<i>hispidia</i> , <i>Sinonipponaphis</i> .....	36, 277, 279
<i>Elytranthe</i> .....	242	<i>hongkongensis</i> , <i>Metanipponaphis</i> .....	262
<i>Elytranthe globosa</i> .....	242	<i>hongkongensis</i> , <i>Thoracaphis</i> .....	262
<i>Euthoracaphis</i> .....	6, 23, 162	<i>Hormaphis</i> .....	180, 181
<i>Euthoracaphis heterotricha</i> .....	26, 36, 43, 162, 163	<i>Hormaphoides</i> .....	181
<i>fici</i> , <i>Astegopteryx</i> .....	250	horns, with hairs, e.g. <i>Astegopteryx</i> , <i>Ceratoglyphina</i> , <i>Ceratovacuna</i> , <i>Pseudoregma</i> .....	50, 127, 136, 204
<i>fici</i> , <i>Thoracaphis</i> .....	250	horns, with one hair, <i>Rappardiella</i> ..	233, 236, 243, 246
<i>ficicola</i> , <i>Nipponaphis</i> .....	37, 38, 187, 192, 194, 270	horns, without hairs, <i>Cerataphis</i> .....	104
<i>Ficus</i> .....	22, 23, 35, 38, 43, 194, 249, 250, 254, 258, 259	<i>Hornstedtia</i> .....	30
<i>Ficus benjamina</i> .....	38, 192, 194, 259	<i>Hornstedtia mollis</i> .....	71



host alternation .....	5, 154	<i>Microstegium</i> .....	31, 39
Hypoxidaceae .....	31, 205	<i>Microstegium ciliatum</i> .....	153
<i>insularis</i> , <i>Cerataphis</i> .....	53, 54, 100	<i>minuta</i> , <i>Astegopteryx</i> .....	27, 41, 52, 59, 66, 68
<i>insularis</i> , <i>Oregma</i> .....	53, 100	<i>minuta</i> , <i>Cerataphis</i> .....	66
<i>japonica</i> , <i>Okajimaia</i> .....	165	<i>minuta</i> , <i>Oregma</i> .....	53, 66
<i>javanica</i> , <i>Nipponaphis</i> ....	37, 44, 187, 188, 189, 193,	<i>Molineria capitulata</i> .....	226
.....	194, 273	<i>montana</i> , <i>Oregma</i> .....	211
<i>javensis</i> , <i>Astegopteryx</i> .....	250	<i>montana</i> , <i>Pseudoregma</i> .....	32, 39, 211, 215
<i>keduensis</i> , <i>Ceratovacuna</i> .....	30, 39, 137, 144, 146	<i>muii</i> , <i>Astegopteryx</i> .....	30, 41, 52, 68, 71, 81, 82
<i>keduensis</i> , <i>Oregma</i> .....	144, 146	<i>muii</i> , <i>Oregma</i> .....	68
<i>Kentia</i> .....	123	<i>multisetosa</i> , <i>Nipponaphis</i> .....	37, 38, 187, 198
<i>lanigera</i> , <i>Ceratovacuna</i> .....	31, 39, 136, 146, 150	<i>Neohormaphis</i> .....	22, 23, 179, 180
<i>lanigera</i> , <i>Oregma</i> .....	146	<i>Neohormaphis caltoa</i> 5, 25, 34, 36, 42, 179, 180, 181	
<i>Lansium</i> .....	36	<i>Nicolaia</i> .....	30, 31, 71, 218, 231
<i>Lansium domesticum</i> .....	270	<i>Nicolaia hemisphaerica</i> .....	231
<i>lataneae</i> , <i>Cerataphis</i> .....	119	<i>Nicolaia speciosa</i> .....	216, 218
<i>Latania</i> .....	116	<i>nicolaiae</i> , <i>Oregma</i> .....	215
<i>lataniae</i> , <i>Cerataphis</i> .....	35, 46, 113, 116, 119, 127	<i>nicolaiae</i> , <i>Pseudoregma</i> .....	31, 205, 215, 216, 218
<i>lataniae</i> , <i>Coccus</i> .....	113	<i>nigra</i> , <i>Ceratoglyphina</i> .....	246
<i>Lithocarpus</i> .....	23	<i>Nipa</i> , see <i>Nypa</i>	
<i>Lithocarpus bennettii</i> .....	37, 201, 203	<i>nipae</i> , <i>Astegopteryx</i> ....	29, 41, 53, 68, 72, 75, 82, 87
<i>Lithocarpus indutus</i> .....	36, 277, 279	<i>nipae</i> , <i>Cerataphis</i> .....	72
<i>Lithocarpus sundaicus</i> .....	37, 44, 175, 179	<i>nipae</i> , <i>Oregma</i> .....	72
<i>Litsea</i> 23, 36, 44, 260, 263, 266, 269, 270, 271, 273		<i>Nipponaphis</i> .....	6, 23, 26, 175, 186, 188, 277
<i>Litsea amara</i> .....	36, 270, 271	<i>Nipponaphis brevipilosa</i> ..	37, 38, 43, 187, 188, 193
<i>Litsea chinensis</i> .....	270	.....	198
<i>Litsea glutinosa</i> .....	26, 44, 269, 270	<i>Nipponaphis distychii</i> .....	186
<i>litseicola</i> , <i>Schizoneuraphis</i> ...	36, 259, 260, 270, 273	<i>Nipponaphis ficicola</i> .....	37, 38, 187, 192, 194, 270
<i>Livistona</i> .....	89	<i>Nipponaphis javanica</i> ....	37, 44, 187, 188, 189, 193,
<i>Livistona altissima</i> .....	89	.....	194, 273
<i>longifila</i> , <i>Ceratovacuna</i> .....	141	<i>Nipponaphis multisetosa</i> .....	37, 38, 187, 198
<i>longisetosa</i> , <i>Schizoneuraphis</i> 34, 43, 259, 260, 273,		<i>Nipponaphis semiglabra</i> .....	37, 187, 201, 203
.....	277	<i>Nypa</i> .....	72, 119, 123
<i>Loranthaceae</i> .....	22, 23, 37, 173, 242, 249	<i>Nypa fruticans</i> .....	72, 75
<i>loranthi</i> , <i>Oregma</i> .....	231, 235	<i>Okajimaia</i> .....	164
<i>loranthi Rappardiella</i> .....	33, 45, 232, 235	<i>Okajimaia japonica</i> .....	165
<i>loranthi</i> , <i>Tuberaphis</i> .....	235	<i>Oplismenus</i> .....	31, 39
<i>Loranthus</i> .....	238, 239, 242, 246, 249	<i>Oplismenus compositus</i> .....	222
<i>Loranthus pentandra</i> .....	173, 249	<i>Orchidaceae</i> .....	35, 46, 104
<i>lutescens</i> , <i>Astegopteryx bambusae</i> col. var. 28, 54,		<i>orchidearum</i> , <i>Cerataphis</i> .....	35, 46, 116, 119
.....	58	<i>orchids</i> .....	119
<i>lutescens</i> , <i>Oregma</i> .....	53, 54, 100	<i>Oregma</i> .....	50, 53, 100, 136, 150, 203, 205, 231
<i>Macrosolen</i> .....	242	<i>Oregma bambusae</i> .....	53, 205, 206
<i>Macrosolen cochinchinensis</i> .....	33, 45, 239, 242	<i>Oregma bambusicola</i> .....	203, 206
<i>macrosoleni</i> , <i>Rappardiella</i> .....	25, 33, 232, 233, 239,	<i>Oregma basalis</i> .....	59, 60
.....	242	<i>Oregma floccifera</i> .....	138
<i>maculata</i> , <i>Astegopteryx bambusae</i> col. var. 28, 54,		<i>Oregma graminum</i> .....	141
.....	58	<i>Oregma insularis</i> .....	53, 99, 100
<i>malaccensis</i> , <i>Trichoregma</i> .....	59, 62	<i>Oregma keduensis</i> .....	144
<i>Melocanna</i> .....	96	<i>Oregma lanigera</i> .....	146
<i>Melocanna bambusoides</i> .....	96	<i>Oregma loranthi</i> .....	231, 235
<i>Mesothoracaphis</i> .....	6, 23, 168, 169	<i>Oregma lutescens</i> .....	53, 54, 100
<i>Mesothoracaphis rappardi</i> .....	26, 37, 44, 170, 173	<i>Oregma minuta</i> .....	53, 66
<i>Metanipponaphis</i> .....	6, 23, 26, 173, 175, 254	<i>Oregma montana</i> .....	211
<i>Metanipponaphis hongkongensis</i> .....	262	<i>Oregma muii</i> .....	68
<i>Metanipponaphis rotunda</i> .....	173	<i>Oregma nicolaiae</i> .....	215
<i>Metanipponaphis vanderghooti</i> 37, 44, 175, 179, 273		<i>Oregma nipae</i> .....	72
<i>Metroxylon sagu</i> .....	123	<i>Oregma pallida</i> .....	75, 76

- Oregma panic* ..... 150  
*Oregma panicola* ..... 218  
*Oregma pendleburyi* ..... 223  
*Oregma pseudosalatigensis* ..... 80  
*Oregma rhapsidis* ..... 86  
*Oregma salatigensis* ..... 75, 76, 80  
*Oregma similis* ..... 53, 54, 57, 100  
*Oregma singaporensis* ..... 76, 94  
*Oregma striata* ..... 53, 54, 59, 100  
*Oregma sundanica* ..... 226  
*orientalis, Ceratovacuna* ..... 141  
*oviparae* ..... 5, 156, 162  
*pallida, Astegopteryx* . 28, 41, 52, 53, 59, 75, 76, 80,  
..... 94, 96  
*pallida, Oregma* ..... 75, 76, 80  
*pallidus, Cerataphis* ..... 75, 80  
*palm* ..... 5, 29, 75, 124  
Palmaeae, see Palmae  
Palmae ..... 35, 45, 51, 116, 119, 123  
*palmae, Aleurocanthus* ..... 119  
*palmae, Aphis* ..... 113  
*palmae, Cerataphis* . 35, 45, 104, 108, 109, 110, 119,  
..... 124, 127  
Pandanaeae ..... 51, 82, 113  
*pandani, Astegopteryx* ..... 29, 52, 81, 82  
*pandani, Trichoregma* ..... 81  
*Pandanus* ..... 82  
*Pandanus tectorius* ..... 81  
*panici, Ceratovacuna* ..... 31, 39, 137, 150, 153  
*panici, Oregma* ..... 150  
*panicola, Oregma* ..... 218  
*panicola, Pseudoregma* .... 31, 38, 39, 205, 218, 223  
*Panicum* ..... 144, 150, 153, 223  
*Paphiopedilum* ..... 119  
parthenogenesis ..... 5  
*Paspalum* ..... 153  
*pendleburyi, Oregma* ..... 223  
*pendleburyi, Pseudoregma* ... 31, 204, 217, 223, 226  
*Phalaenopsis* ..... 119  
*Phyllostachys kumasaca* ..... 132  
*Phyllostachys sulphurea* ..... 168  
*plicator, Rappardiella* .... 33, 45, 231, 233, 242, 246  
*pothophila, Cerataphis* ..... 35, 45, 124, 127  
*Pothos* ..... 45, 127  
*Pothos herrmaphroditus* ..... 35  
*Pothos longifolius* ..... 113  
*Pothos roxburghii* ..... 35, 45, 124, 127  
*Pseudoastegopteryx* ..... 50  
*Pseudoregma* ..... 5, 22, 24, 203, 205, 232  
*Pseudoregma albostriata* ..... 206  
*Pseudoregma bambusicola* ..... 32, 40, 204, 206, 211,  
..... 225  
*Pseudoregma graminum* ..... 141  
*Pseudoregma montana* ..... 32, 39, 211, 215  
*Pseudoregma nicolaiiae* ..... 31, 205, 215, 216, 218  
*Pseudoregma panicola* ..... 31, 38, 39, 205, 218, 223  
*Pseudoregma pendleburyi* .... 31, 204, 217, 223, 226  
*Pseudoregma sundanica* . 31, 40, 216, 217, 226, 231  
*pseudosalatigensis* ..... 80  
*Quercus* ..... 22, 23, 25, 36, 42, 180, 181, 183, 186,  
..... 198, 285  
*rappardi, Astegopteryx* .... 29, 40, 41, 51, 52, 82, 85,  
..... 87, 97  
*rappardi, Mesothoracaphis* ..... 26, 37, 44, 170, 173  
*rappardi, Thoracaphis* ..... 168, 169, 170  
*Rappardiella* ..... 22, 231, 233  
*Rappardiella cerina* ..... 33, 232, 233, 235  
*Rappardiella loranthi* ..... 33, 45, 232, 235, 239  
*Rappardiella macrosoleni* .. 25, 33, 45, 232, 233, 239,  
..... 242  
*Rappardiella plicator* .... 33, 45, 231, 233, 242, 246  
*Rappardiella scurrulae* ..... 33, 232, 246, 249  
*Reticulaphis* ..... 24, 26, 249, 250, 259  
*Reticulaphis distylii* ..... 5, 22, 34, 35, 43, 185, 186,  
..... 249, 250, 259, 269  
*Reticulaphis distylii* subsp. *rotifera* .. 250, 253, 257  
*Reticulaphis shiiae* ..... 249  
*rhapsidis, Astegopteryx* .... 29, 40, 41, 52, 53, 86, 90  
*rhapsidis, Oregma* ..... 86  
*Rhapis* ..... 90  
*Rhapis javanica* ..... 89  
*rotifera, subsp. of Reticulaphis distylii* ..... 250, 253  
..... 257  
*rotunda, Metanipponaphis* ..... 173  
*Saccharum* ..... 31  
*Saccharum officinarum* ..... 149  
*Saccharum spontaneum* ..... 149  
*Salacca* ..... 75, 123  
*Salacca edulis* ..... 75, 123  
*salatigensis, Astegopteryx* ..... 76, 80  
*salatigensis, Oregma* ..... 75, 76, 80  
*Schizoneuraphis* ..... 23, 24, 26, 249, 259, 262  
*Schizoneuraphis distylii* ..... 250, 259  
*Schizoneuraphis foliorum* ..... 154, 155, 259  
*Schizoneuraphis gallarum* ..... 5, 26, 34, 36, 44, 259,  
..... 260, 262, 263, 270, 271  
*Schizoneuraphis litseicola* .... 36, 259, 261, 270, 273  
*Schizoneuraphis longisetosa* ... 34, 43, 259, 260, 273  
..... 277  
*Schizostachyum* ..... 31, 132  
*Schizostachyum blumii* ..... 27, 96, 132, 226  
*Schizostachyum brachycladum* ..... 96, 132, 168  
*Schizostachyum zollingeri* ..... 27, 132  
*Scurrula* ..... 33, 44, 45, 238, 239, 242, 245, 248  
*Scurrula korthalsii* ..... 238  
*scurrulae, Rappardiella* ..... 33, 44, 232, 246, 249  
*semiglabra, Nipponaphis* ..... 37, 187, 201, 203  
*Serrataphis striatus* ..... 53  
*Setaria* ..... 31, 39  
*Setaria palmifolia* ..... 153, 222  
*setigera, Astegopteryx* ..... 5, 32, 38, 50, 90, 94  
*Shibataea kumasana* ..... 168  
*shiiae, Reticulaphis* ..... 249  
*similis, col. var. of Astegopteryx bambusae* ..... 58  
*similis, Oregma* ..... 53, 54, 57, 100  
*singaporensis, Astegopteryx* ..... 29, 76, 94, 96  
*singaporensis, Oregma* ..... 76, 94  
*Sinonipponaphis* ..... 6, 22, 277

- Sinonipponaphis hispida* ..... 36, 277, 279  
soldier, (defence with fore legs and horns):  
*Ceratovacuna floccifera* ..... 137, 141  
*Distylaphis* ..... 155  
*Distylaphis foliorum* ..... 160  
*Pseudoregma* ..... 205  
*Pseudoregma bambusicola* ..... 210  
*Pseudoregma montana* ..... 215  
*Pseudoregma panicola* ..... 222  
*Pseudoregma pendleburyi* ..... 225  
*Pseudoregma sundanica* ..... 230  
soldier (defence with stinging stylets):  
*Astegopteryx setigera* ..... 93  
*Astegopteryx styracophila* ..... 99  
*striata*, col. var. of *Astegopteryx bambusae* .. 28, 58  
*striata*, *Oregma* ..... 53, 54, 59, 100  
*striata*, *Serrataphis* ..... 53  
Styracaceae ..... 99  
*styracophila*, *Astegopteryx* 5, 32, 40, 50, 90, 96, 99  
*Styrax* . 5, 21, 40, 50, 57, 59, 96, 103, 109, 124, 232  
*Styrax benzoin* ..... 5, 32, 40, 45, 50, 90, 94, 99, 105,  
..... 108, 109  
*sundanica*, *Oregma* ..... 226  
*sundanica*, *Pseudoregma* 31, 40, 216, 217, 226, 231  
*Synonycha grandis* ..... 211  
*Thoracaphis* ..... 23, 162, 169, 175, 279, 281  
*Thoracaphis arboris* ..... 25, 36, 42, 279, 281, 285  
*Thoracaphis fici* ..... 250  
*Thoracaphis hongkongensis* ..... 262  
*Thoracaphis rappardi* ..... 168, 169, 170  
*Thoracaphis umbellulariae* ..... 162  
*Trichoregma* ..... 50, 59  
*Trichoregma flava* ..... 59, 60, 62  
*Trichoregma malaccensis* ..... 59, 62  
*Trichoregma pandani* ..... 81  
*Trichoregma vandermeermohri* ..... 59, 62  
*Tuberaphis loranthi* ..... 235  
*umbellulariae*, *Thoracaphis* ..... 162  
*unimaculata*, *Astegopteryx* .. 27, 41, 54, 59, 99, 102  
*Vacuna* ..... 138  
*Vanda* ..... 119  
*Vanda tricolor* ..... 119  
*vandergooti*, *Metanipponaphis* 37, 44, 175, 179, 273  
*vandermeermohri*, *Trichoregma* ..... 59, 62  
*variabilis*, *Cerataphis* ..... 119  
*Viscum* ..... 173  
*Viscum articulatum* ..... 26, 37, 44, 170, 173  
wax, abdominal cushion pls. .... 16, 38, 39, 47  
wax, columns pls. .... 10, 37, 43  
wax, flaky pls. .... 16, 46, 47  
wax, flocky pl. .... 30  
wax, fringe pls. .... 1, 21, 23, 24  
wax, glassy wax-rod ..... 258  
wax, granular pls. .... 16, 38, 41, 42, 46  
wax, hairs pl. .... 23  
wax, layer of wax pls. .... 19, 44  
wax, powder pls. .... 9, 10, 13, 35  
wax, shiny, but white when damaged pls. .... 22,  
..... 24, 36, 45  
wax, snow pl. .... 14  
wax, snow flakes pl. .... 29  
wax, threads pl. .... 28  
wax, transparent pls. .... 34, 36, 45  
wax, woolly pl. .... 7  
wax glands, button organs . 6, 180, 183, 185, 258  
....., 269  
wax glands, circular-oval, in groups e.g. . 47, 54,  
..... 110, 130, 144, 212, 236  
wax glands, circular-oval, separate . 47, 156, 285  
wax glands, circular-oval, irregular ..... 72  
wax glands, convolutions ..... 6, 240, 263  
wax glands, dotted areas ..... 178, 181, 183  
wax glands, linear areas ..... 252, 274  
wax glands, lines without interruption ..... 161  
wax glands, pustules, e.g. ... 6, 163, 175, 178, 183,  
..... 189, 195, 206, 208, 223, 243  
wax glands, angular discs with furrows ..... 175  
wax glands, star-shaped . 208, 217, 218, 224, 227  
wax glands, stripes, radial ..... 282  
wax glands, wart-like ..... 165  
wax glands, s-shaped, linear 6, 69, 207, 234, 239,  
..... 240  
wrakas ..... 281  
wranak ..... 175, 179  
*Zalacca*, see *Salacca*  
*Zingiber* ..... 71, 231  
Zingiberaceae ..... 31, 51, 71, 205, 231